



OWNER'S INSTRUCTIONS

Z-850/870/890

VIDEO-CD/CD/MP3-CD PLAYER

Before operating the unit, please read this manual thoroughly, and retain for future reference.

Z-850

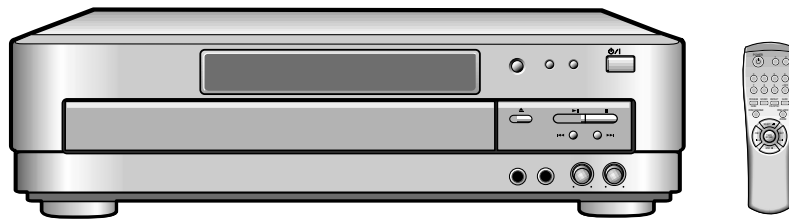

Z-870

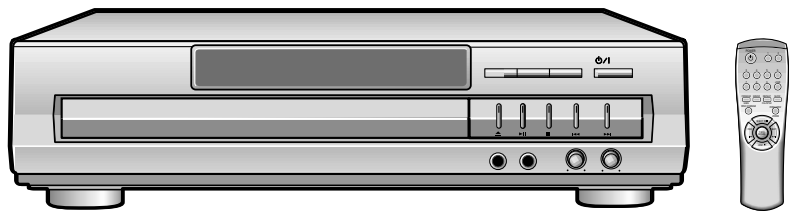

Z-890

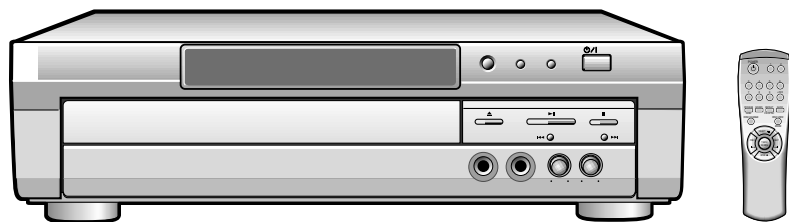

This player does not apply to business use and CD-ROM/CD graphic discs cannot be played with this player.

Even though the MP3-CD that you purchased contains the 'MP3' mark on its cover, the disc not written data by the format of MPEG1 LAYER3(file extension name: .MP3) can not be played back normally.

SAFETY PRECAUTIONS

**CLASS 1 LASER PRODUCT
KLASSE 1 LASER PRODUKT
LUOKAN 1 LASER LAITE
KLASS 1 LASER APPARAT
PRODUCTO LASER CLASE 1**

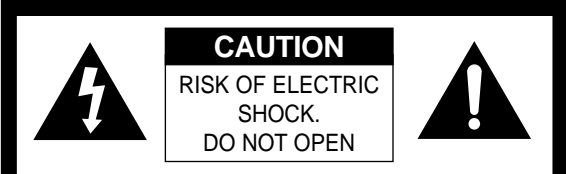

CAUTION:
TO REDUCE THE RISK OF ELECTRIC SHOCK, DO NOT REMOVE REAR COVER. NO USER SERVICEABLE PARTS INSIDE. REFER SERVICING TO QUALIFIED SERVICE PERSONNEL.

CLASS 1 LASER PRODUCT

This Compact Disc player is classified as a CLASS 1 LASER product.

Use of controls adjustments or performance of procedures other than those specified herein may result in hazardous radiation exposure.

**CAUTION-INVISIBLE LASER RADIATION
WHEN OPEN AND INTER LOCKS
DEFEATED, AVOID EXPOSURE TO BEAM.**

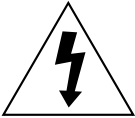

This symbol indicates that dangerous voltage which can cause electric shock is present inside this unit.



This symbol alerts you to important operating and maintenance instructions accompanying the unit.

WARNING: To reduce the risk of fire or electric shock, do not expose this appliance to rain or moisture.

This unit contains no user serviceable parts.

Never remove covers unless qualified to do so.

This unit contains dangerous voltages, always remove main plug from the socket before any service operation and when not in use for a long period.

CAUTION: To prevent electric shock, match wide blade of plug to wide slot, fully insert.

NOTE TO CATV SYSTEM INSTALLER: This reminder is provided to call the CATV system installer's attention to article 820-40 of the NEC provides guidelines for proper the cable ground shall be connected to the grounding system of the building, as close to the point of cable entry as practical.

CONTENTS

| | |
|---|----|
| PRECAUTIONS..... | 3 |
| CONTROLS AND COMPONENTS..... | 4 |
| REMOTE CONTROL..... | 5 |
| TO INSERT BATTERIES | 5 |
| SYSTEM CONNECTIONS | 6 |
| MP3-CD PLAYBACK..... | 7 |
| VIDEO-CD PLAYBACK | 8 |
| DISC VIEW FUNCTION | 9 |
| REPEAT FUNCTION | 9 |
| PROGRAM FUNCTION | 10 |
| ZOOM FUNCTION | 10 |
| SEARCHING FUNCTIONS | 11 |
| KARAOKE FUNCTION | 12 |
| TROUBLE SHOOTING | 13 |
| WHEN VIDEO IS DISPLAYED THROUGH SET..... | 14 |
| PRECAUTIONS WHEN USAING COMPACT DISCS | 14 |
| SPECIFICATIONS..... | 14 |

PRECAUTIONS

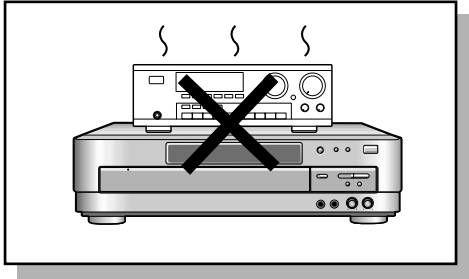
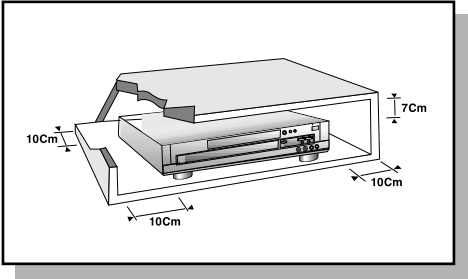

Ensure that the AC power supply in your house complies with the identification sticker located on the back of your player. Install your player horizontally, on a suitable base (furniture), with enough space around it for ventilation (3-4inches). Make sure the ventilation slots are not covered. Do not stack anything on top of the player. Do not place the player on amplifiers or other equipment which may become hot. Before moving the player, ensure the disc tray is empty. This player is designed for continuous use. Switching off the player to the stand-by mode does not disconnect the electrical supply. In order to disconnect the player completely from the power supply, remove the main plug from the wall outlet, especially when left unused for a long period of time.

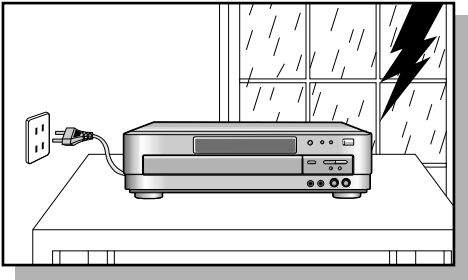

During thunderstorms, disconnect the main plug from the socket. Main voltage peaks due to lightning could damage the unit.

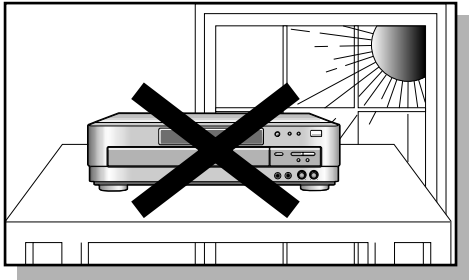

Do not expose the unit to direct sun radiation or other heat sources. This could lead to overheating and malfunction of the unit.

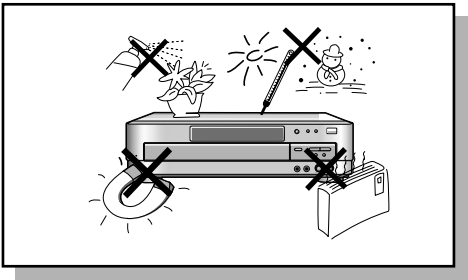

Protect the player from moisture(dripping or splashing and that no objects filled with liquids,such as vases, shall be placed on the player), and excess heat(e.g.fireplace) or equipment creating strong magnetic or electric fields (i.e.speakers...) disconnect the power cable from the mains electricity supply if the player malfunction. Your player is not intended for industrial use but for domestic purposes only. Use of this product is for personal use only. Condensation If your player or disc have been stored in a cold atmosphere. as for example during transportation in the winter, wait for approximately 2 hours until they have reached room temperature.

CONTROLS AND COMPONENTS

FRONT PANEL

Z-850

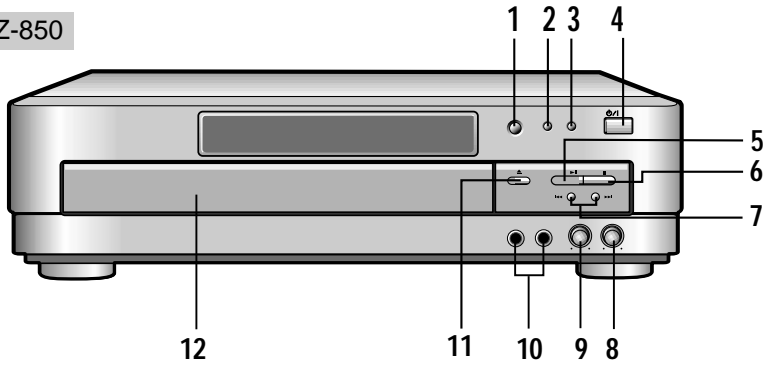

Z-870

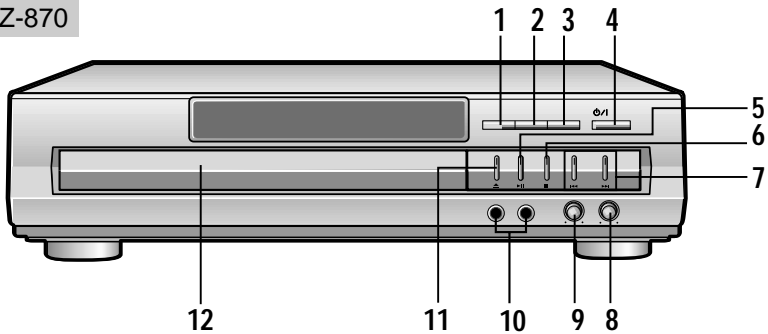

Z-890

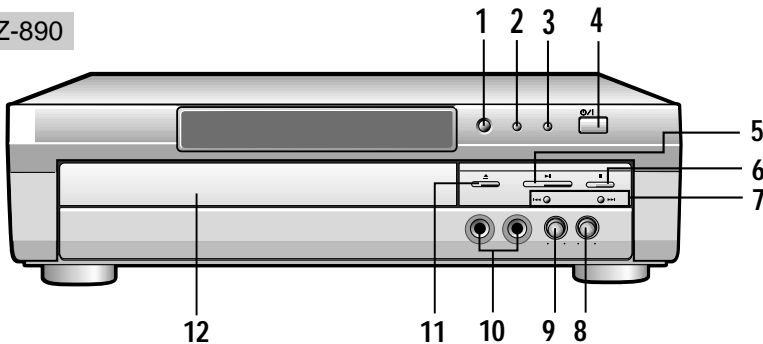

1. Disc Change button
2. Key Control **b** button
3. Key Control **#** button
4. Standby/On button
5. Select(Play/Pause) button
6. Return(Stop) button
7. Previous/Next buttons
8. Digital Echo Volume knob
9. Mic Volume knob
10. Mic jacks
11. Open/Close button
12. Disc Tray

REAR PANEL

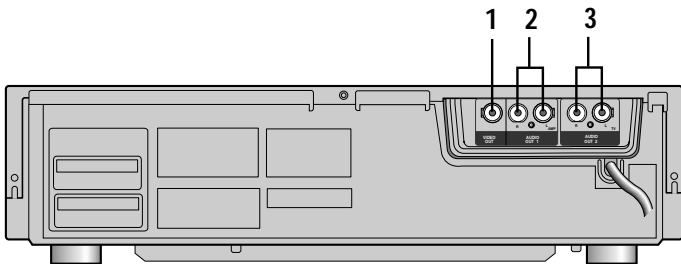

1. VIDEO OUTPUT
- Connect to the VIDEO IN of your TV set.
2. AUDIO OUTPUT
- Connect to the AUDIO IN of your stereo amplifier.
3. AUDIO OUTPUT (TV)
- Connect to the AUDIO IN of your TV set.

REMOTE CONTROL

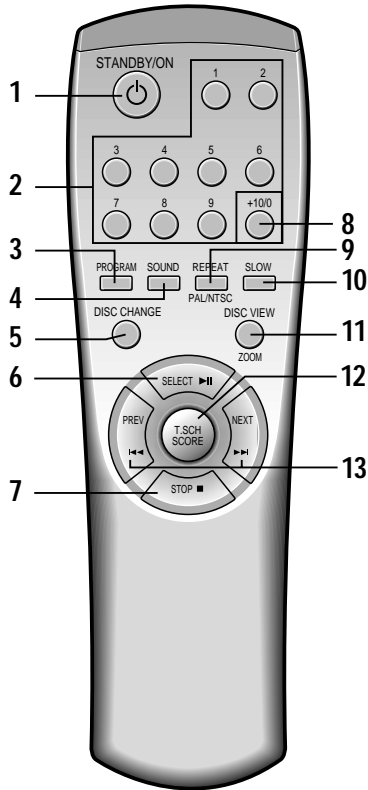

1. STANDBY/ON button
2. DIGIT buttons
3. PROGRAM button
4. SOUND Selector button
5. DISC CHANGE button
6. SELECT(PLAY/PAUSE) button
7. STOP (RETURN) button
8. +10 button(for CD or VCD)
- 0 button(for MP3-CD)
9. REPEAT/PAL/NTSC button
10. SLOW button
11. DISC VIEW/ZOOM button
12. TIME SEARCH/LAST MEMORY/SCORE button
13. PREVIOUS/NEXT button

TO INSERT BATTERIES

1 Open the battery compartment cover.

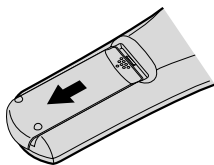

2 Install two "AAA" batteries observing the correct polarity as shown in compartment.

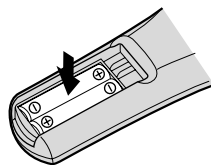

3 Replace the cover.

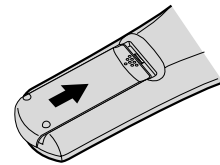

ACCESSORIES

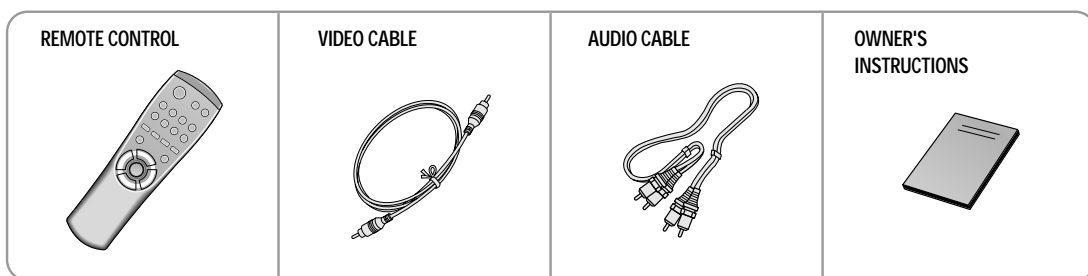

SYSTEM CONNECTIONS

VCD AND CDP + TV

1. Connect VIDEO OUT jack of the VCD to VIDEO IN jack of the TV.
2. Connect AUDIO OUT jack of the VCD to AUDIO IN jack of the TV.

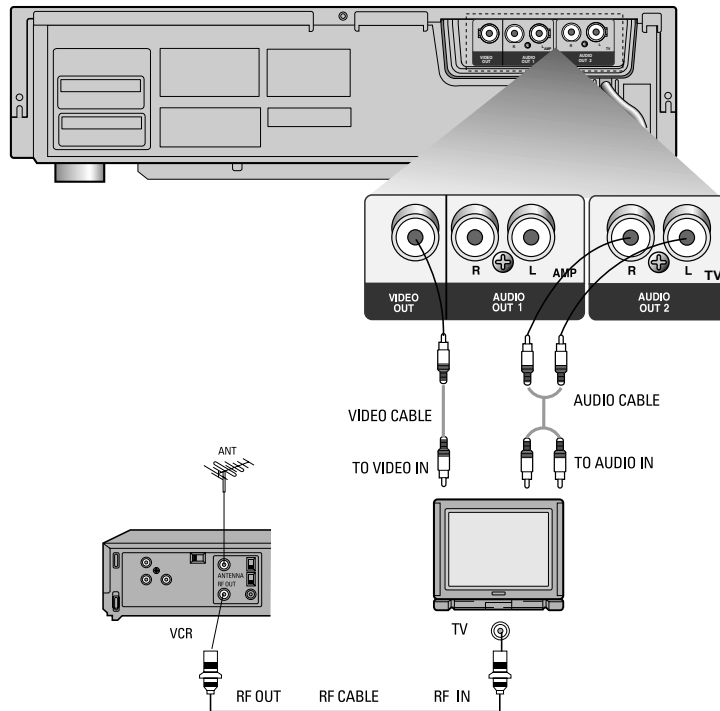

VCD AND CDP + TV + AMPLIFIER

1. Connect VIDEO OUT jack of the VCD to VIDEO IN jack of the TV.
2. Connect AUDIO OUT jack of the VCD to the AUX or CD INPUT jacks of the AMPLIFIER.

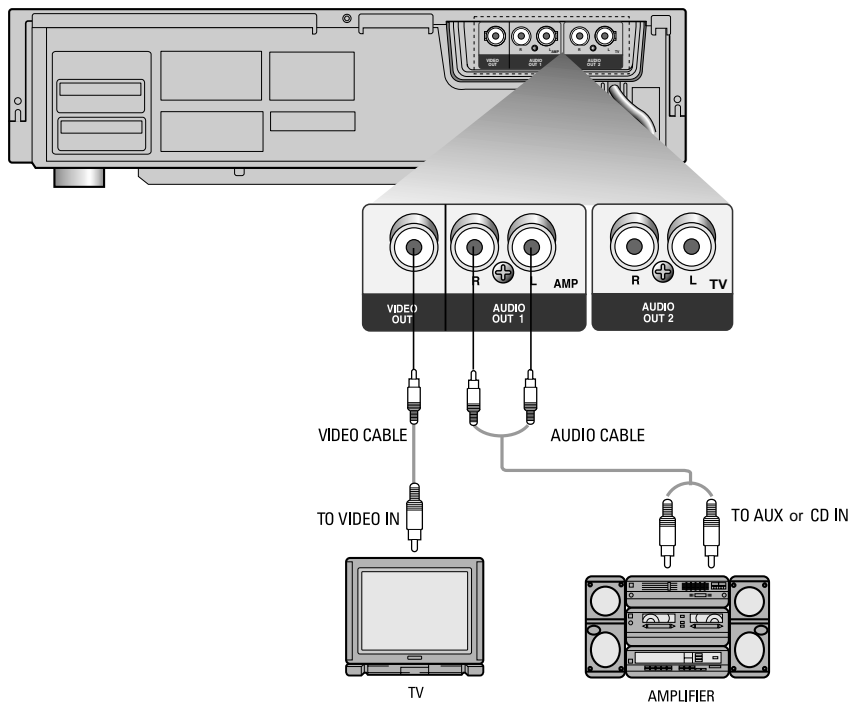

MP3-CD PLAYBACK

- This is a player that enables the playback of VCD, audio CD, CD-R, CD-RW and MP3-CD and does not possess the function that saves MP3 files.

HOW TO PLAY BACK MP3-CD directly

- 1 After inserting MP3-CD in the set, press the SELECT (▶||) button or digit button after Reading.
- 2 You can see the information of Disc on the TV.

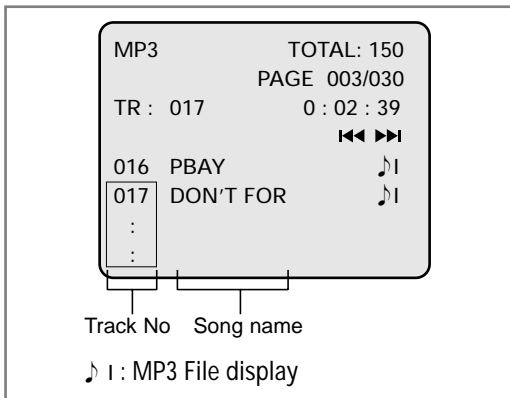

- Press the Previous/Next (◀◀, ▶▶) buttons to move on to the next or previous track.
- Select the DIGIT button for track number and Press the Select (▶||) button.
- 7 tracks are displayed on the PAL TV screen.
- 5 tracks are displayed on the NTSC TV screen.

NOTE

- Song names are marked by only English and digits. But unsupported Data are marked by "#".
- Do not play cracked, scratched or warped discs.

WHAT IS MP3?

- MP3 means MPEG1 Layer 3, the global standard for audio signal compression technology. It uses digital compression technology to compress original sound data by up to 12 times without sound quality degradation.

When playing a CD-R or CD-RW

User-edited CD-Rs (Recordable) and CD-RWs (Rewritable) can be played back only if they are already "finalized".

- You can play back your original CD-Rs or CD-RWs recorded in music CD format. (However, they may not be played back depending on their characteristics or recording conditions.)
- Some CD-Rs or CD-RWs may not be played back on this unit because of their disc characteristics, damage or stain on them, or if the player's lens is dirty.
- CD-RWs may require a longer readout time. (This is caused by the fact that the reflectance of CD-RWs is lower than for regular CDs.)

HOW TO PLAY BACK MP3-CD on MENU MODE

- 1 After inserting MP3-CD in the set, press the DISC VIEW button in the stop mode.
 - You can see the following information of Disc on the TV.
 - Press the Previous/Next (◀◀, ▶▶) buttons to move on to the next or previous directory.

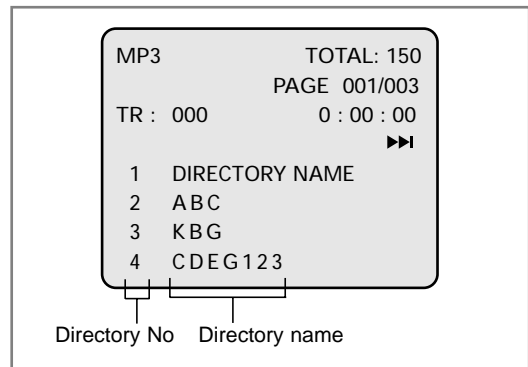

- 2 Select the number of directory.

- You can see the following Display.
- Press the Previous/Next (◀◀, ▶▶) buttons to move on to the next or previous song.

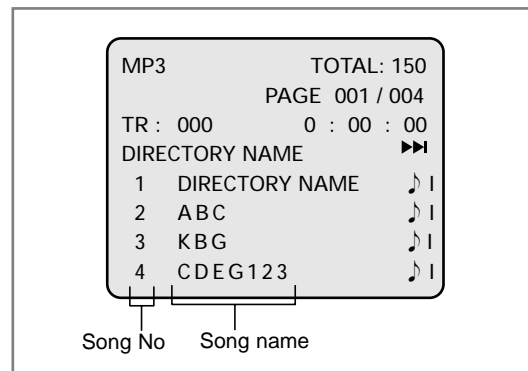

- 3 Select the number of song and you can enjoy the music.

TO RETURN TO THE PREVIOUS MENU

Press the RETURN button.

- When a wrong menu is selected or other menu is about to be selected, hold down the RETURN button more than one second.
- When the RETURN button is pressed shortly, the disc may be stopped.

VIDEO-CD PLAYBACK

HOW TO PLAY BACK VIDEO-CD version 2.0

- 1 Press the Open/Close button.
 - The tray is ejected.
- 2 Insert a Video-CD and press the Open/Close button.
 - Press the DISC CHANGE button for tray number selection.
- 3 Press the SELECT (▶||) button.
 - In version 1.1 disc menu is not displayed and play function is operated.
 - Only in version 2.0 disc menu is displayed.
 - If you press directly the digit button at stop mode, start to play the track of selected digit number without menu picture.

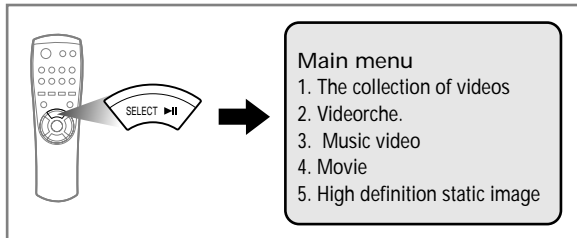

- 4 Select a number from the menu and press it.
 - Ex) In the case of selecting No. 1 the collection of videos.

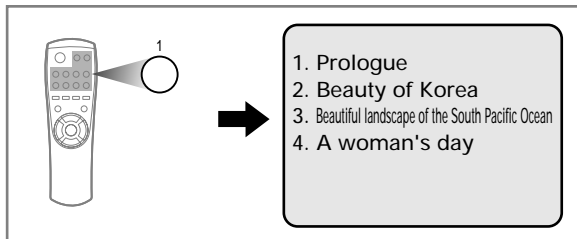

TO RETURN TO THE PREVIOUS MENU

Press the RETURN button.

- When a wrong menu is selected or other menu is about to be selected, hold down the RETURN button more than one second.
- When the RETURN button is pressed shortly in Video-CD version 2.0, the disc may be stopped.
- Press the NEXT button, the next menu will be displayed. Press the PREVIOUS button, the previous menu will be displayed.

NOTE

In the case of menu mode

- PROGRAM, TIME SEARCH, REPEAT, DISC VIEW functions do not work.

SLOW MOTION

- 1 Press the SLOW button on the remote control when the play function is on.
 - The sound is muted during the slow playing.
 - Slow playing is 1/2 of the normal playing speed at 1st press.
 - Slow playing is 1/4 of the normal playing speed at 2nd press.
 - Slow playing is 1/8 of the normal playing speed at 3rd press.
 - Slow playing is canceled at 4th press.
- 2 Press the SELECT (▶||) button to return to normal operation.

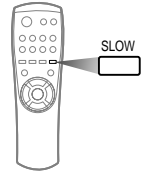

NTSC/PAL SELECTION METHOD

- Press the PAL/NTSC(REPEAT) button for 1 second or longer on stop mode. You can matching the picture display on your TV.

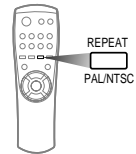

DISC CHANGE FUNCTION

To replace disc

- Press the Return(STOP) button.
- Eject the tray by pressing the Open/Close button.
- Press the DISC CHANGE button to rotate the tray.

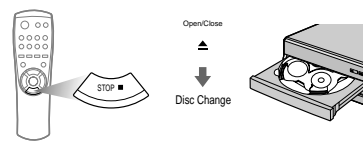

SELECT SOUND TO YOUR PREFERENCE

Press the SOUND button during playback.

- Every time you press this button, sound changes as show below.

| | Screen on your TV monitor | Audio Output | |
|------------|---------------------------|--------------|----------|
| | | L-ch | R-ch |
| 1st press. | L-CH | L-signal | L-signal |
| 2nd press. | R-CH | R-signal | R-signal |
| 3rd press. | STEREO | L-signal | R-signal |

DISC VIEW FUNCTION

- Desired music or video display can be used directly without by menu functions (VER 2.0 Mode).
- This function is possible in VCD Ver 1.1 and Ver 2.0 menu off mode.

TRACK VIEW

- This function is performed in the stop mode.
- This function is used for show the first views by nine in track.

- 1 Press the DISC VIEW button.
 - Nine tracks are presented with sound.
 - In case the number of tracks is more than ten, press the NEXT button.

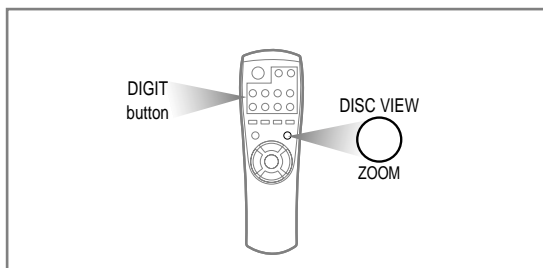

- 2 Press the DIGIT button to select Track View.
 - The selected track is displayed on the small screen with sound played.
- 3 Press the SELECT (Play/Pause) button.
 - Displayed in full screen.

INDEX VIEW

- This function acts as displaying the track in playing sequently by time and so it's convenient for searching desired video.

- 1 Press the SELECT (▶||) button to playback.
- 2 Press the DISC VIEW button.
 - The display as dividing into nine equal parts in displayed together with relevant sound.
- 3 Press the DIGIT button to play back the desired part number.
 - It's displayed from the selected part in full screen.

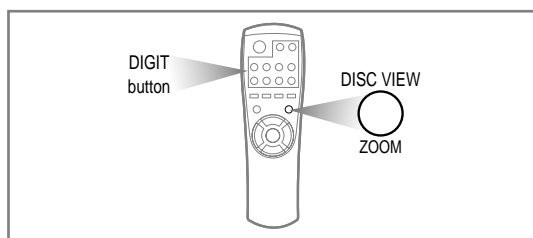

9

REPEAT FUNCTION

- Turn on the TV.
- Load and play a disc.

- 1 To repeat one track, press the REPEAT button once.
 - "REPEAT" indicating the one track repeat lights and the one track is played repeatedly.
- 2 To repeat one DISC, press the REPEAT button twice.
 - "REPEAT" indicating the one disc repeat lights and the one disc is played repeatedly.
- 3 To repeat all DISC, press the REPEAT button three times.
 - "REPEAT" indicating the all discs repeat lights and all of the discs are played repeatedly.
- 4 To end repeat play, press the REPEAT button at the all discs repeat mode.

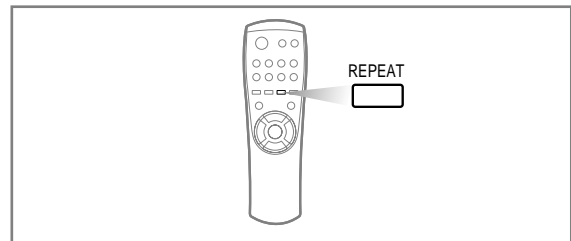

PROGRAM FUNCTION

- This function can program up to 30 tracks during stop mode.
- ex) To program No.4 track of No.2 disc

1 Press the PROGRAM button.

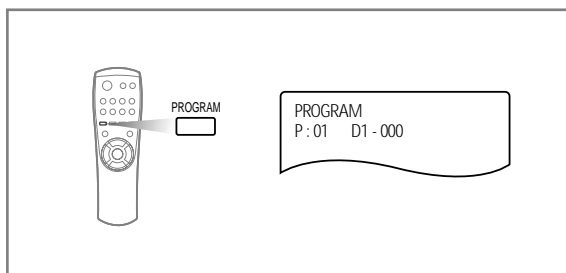

2 Select the disc by pressing the DISC CHANGE button.

- Press the DISC CHANGE button.

3 Press the track number to be programmed.

- Press the digit buttons.
- Ex) Select track 4

4 In a second

- After step 3, you must press the PROGRAM button again then the selected number is programmed.
- Up to 30 tracks can be programmed by repeating step 2 to 4.

5 Press the PLAY/PAUSE button.

- Programming is completed, and the first track of the program is played.
- When the Previous/Next button is pressed, the next or previous programmed track is played.

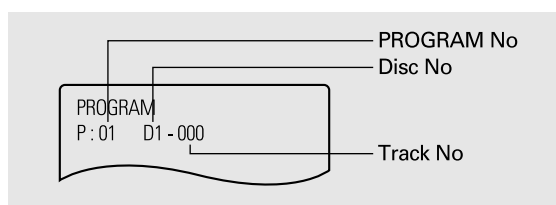

NOTE

- If the PROGRAM button is pressed during programming, it can not be programmed anymore, press again to continue.
- To escape program function, Press the Open/Close button, or press the STOP button twice.

ZOOM FUNCTION

- This function works only in the VCD play mode.

1 Press and hold the ZOOM to button to change the screen to 2 x ZOOM.

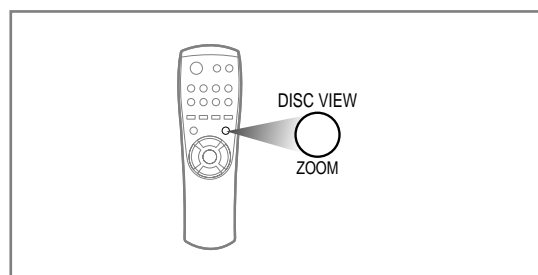

2 While in the 2 x ZOOM screen, press and hold the ZOOM button again to change the screen to 4 x ZOOM.

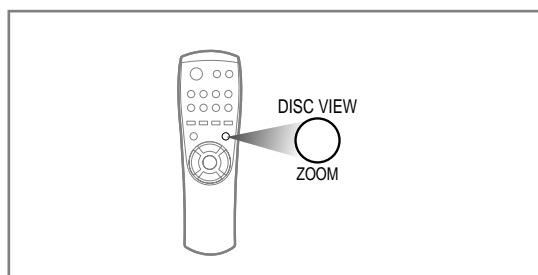

3 While in the stage of No.1 or No.2 above, press the ◀◀, ▶▶, ▶▶, ■ buttons to scroll the screen to the left, right, up, or down.

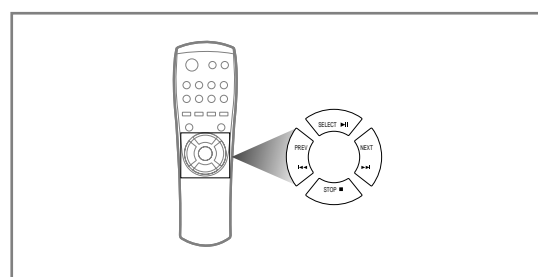

4 While in the 4 x ZOOM, press and hold the ZOOM button, and display normal picture.

SEARCHING FUNCTIONS

HIGH SPEED SEARCH

Press and hold down the Previous/Next (◀◀, ▶▶) button.

- When the pressed button is released, it returns to the normal play.

SKIP

Press the Previous/Next (◀◀, ▶▶) button.

- When the Previous (◀◀) button is pressed, it returns to the beginning of the currently playing track. If pressed again, it returns to the previous track.
- Picture moves to the beginning of the next track whenever Next (▶▶) button is pressed.
- When the Previous or Next button is pressed while playing a disc such as a movie disc, it quickly advances 5 minutes in the forward/reverse direction.

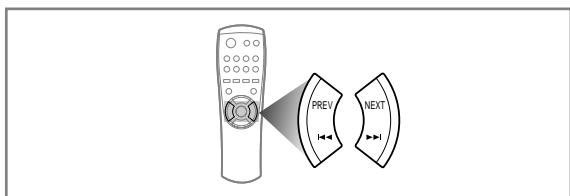

NOTE

In case of high speed search

- When searching a CD disc, the volume is lowered and it advances in high speed.
- If the search does not operate properly due to the noise, release the button momentarily and press it again.
- When the search for a Video-CD is released, mosaic screen might appear or the screen might advance slower than the audio for a short period of time.
- If you choose 'SCAN' in the middle of playing back your MP3-CD, SOUND is not played.

+10 FUNCTION

- This function is available only during the playback of a CD/Video-CD.
- Press the +10/0 button. The track 10 tracks after the current one will then be played back.
Ex) If you want to select track 43 during playback of track 15, press the +10/0 button four times, and then press the ▶▶ button three times or Digit 3 button once.
- Press the +10/0 button at MP3-CD playing, digit "0" will be entered.
Ex) If you want to select track 80 during playback, press the digit "8" and "0" buttons.

TIME SEARCH FUNCTION

- 1 Press the TIME SEARCH button during playback.

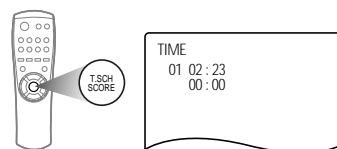

- 2 Enter the time by pressing the DIGIT button.

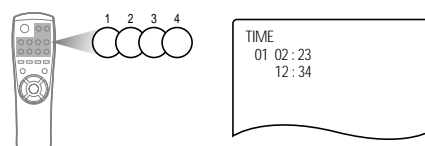

- 3 Press the SELECT (▶||) button.

NOTE

1. If entering the time is greater than total time of the disc, it will not be entered.
2. If entering the time is greater than track time it will play next track.
3. This function works only for playing mode.
4. This function can operate only for Menu off mode of Video-

LAST MEMORY FUNCTION

- If you press the STOP or STANDBY/ON button during Videi-CD playback, a playback position slightly ahead of the current time or track is stored in the unit's memory.
- When you press the STOP or STANDBY/ON button to finish the operation, Press TIME SEARCH button and this unit will search for original position.

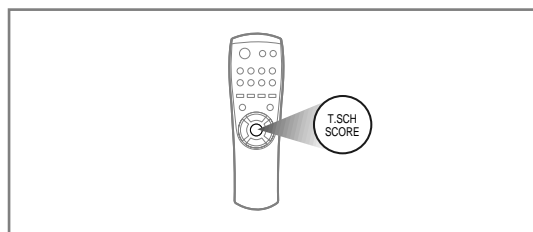

NOTE

1. Last memory play is always operated as menu off mode even if last status is menu on.
2. If you press STOP and OPEN, this function will be cancelled.

KARAOKE FUNCTION

- Turn on the TV.
- Load and play a disc.

MICROPHONE FUNCTION

- 1 Connect the MIC.
 - The key control will be displayed on the screen.

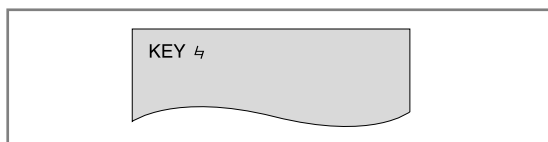

- 2 Load a disc and select a desired track.

- 3 Use the microphone.
 - Two microphones can be used at the same time.

KEY CONTROL FUNCTION

- Make sure to be at the karaoke mode.
- Press the Key Control button to adjust the key to suit to your voice. (the 15 step key control)

ex) In case of pressing # :

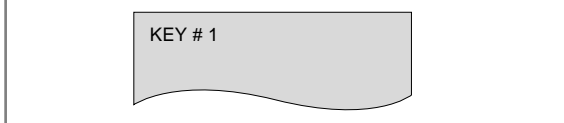

- On screen display will disappear in 3 seconds.

ex) In case of pressing # once more:

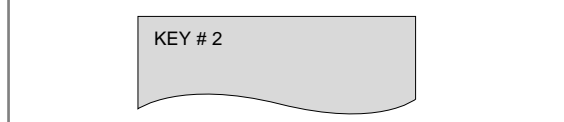

NOTE

- Depending on a type of Video-CD 2.0 disc, it may be not operated Key Control function in still picture.
- This function is operated only on VCD Mode.

ADJUST THE DIGITAL ECHO

- This will add an echo to your voice, giving you the feeling of singing on stage.

(For example :)

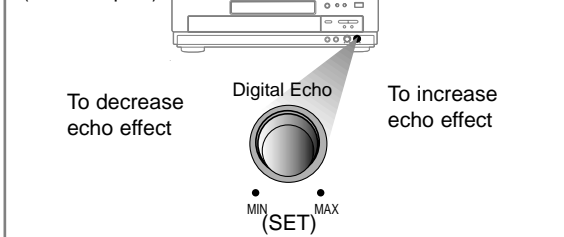

TO DECREASE OR INCREASE THE VOLUME OF THE MICROPHONE

- Turning to the left decreases Mic Vol.
- Turning to the right increases Mic Vol.

(For example :)

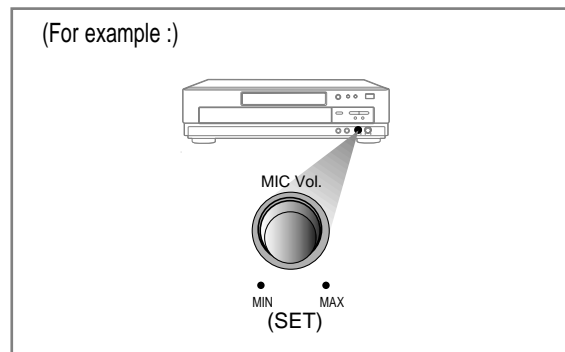

If howling occurs:

- Reduce the microphone volume.
- Change the direction that the microphone faces.
- Move the microphone away from the speaker.

SCORE FUNCTION

- This function is operated only on VCD Menu off mode.
- Connect the mic.
- Press and hold the SCORE button on the remote control. Then it will pause automatically at the end of the track.
- When you finish singing a song, the SCORE will be displayed on your TV monitor.
- To cancel this function, press and hold the SCORE button again.
- This function is possible in VCD Ver 1.1 and Ver 2.0 menu off mode.

(For example :)

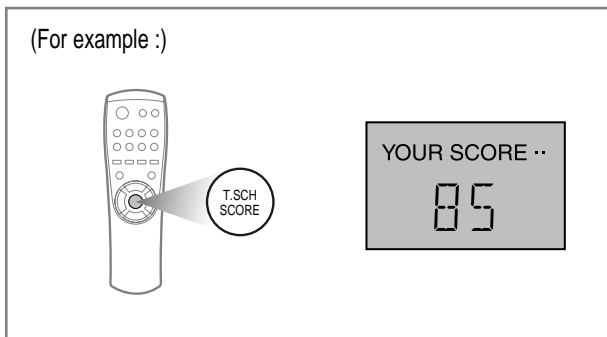

TROUBLE SHOOTING

| SYMPTOM | CHECK AND ACTION |
|--|--|
| Tray is not ejected. | <ul style="list-style-type: none"> • Check if the power is turned on. |
| The unit does not play | <ul style="list-style-type: none"> • Check if a disc is loaded. |
| Tray is ejected. | <ul style="list-style-type: none"> • Check if a disc is contaminated or damaged. Remove disc, clean it and insert again. • Check if a disc is seated properly. |
| Video or audio is muted, or tray is ejected after 2-5 seconds. | <ul style="list-style-type: none"> • Check for condensation in unit. • Removed disc, leave the unit with the power turned on for 1-2 hours. The unit will operate only after the condensation is cleared. |
| Picture appears late when SELECT(PLAY/PAUSE) button is pressed. | <ul style="list-style-type: none"> • Repeated pressing of PLAY/STOP/OPEN caused disc drive motor to over heat, and protection circuit activated until motor cools down. |
| Does not have video although disc is turned. | <ul style="list-style-type: none"> • Check if TV power is turned on. • Check if connection is secure. • Check if the unit is bypassed. |
| Picture shakes vertically. | <ul style="list-style-type: none"> • Picture may shakes momentarily during transition from dark to bright. |
| Picture quality of a particular disc is poor and picture shakes | <ul style="list-style-type: none"> • Check if disc is damaged or deformed. • Check if disc is contaminated. |
| SKIP or SEARCH takes too much time. | <ul style="list-style-type: none"> • Some discs may require longer time to read encoded information. • Check disc. |
| TIME SEARCH searches different time. | <ul style="list-style-type: none"> • Check if disc is contaminated or deformed. • When picture shakes disc may be contaminated or deformed causing malfunction. Clean disc |
| After pressing the SELECT(PLAY/PAUSE) button, there is a long delay before picture appears on screen. | <ul style="list-style-type: none"> • If the PLAY/STOP/OPEN/DISC CHANGE operations are repeated within short period of time, the Disc Drive Motor overheats. The disc will not rotate until the motor cools down. This is a normal condition. Wait a few minutes for the motor to cool down. |
| The disc rotates well, but you do not have picture on the screen, You can see the picture on screen, but the quality is poor and the picture shakes. | <ul style="list-style-type: none"> • Check if the TV power is turn on. • Check if the connection is good. • Check if the disc is in good condition. |
| No sound | <ul style="list-style-type: none"> • Check if disc is loaded upside down. • Insert disc with label side up. • Check if disc is severely deformed. Clean the disc |

WHEN VIDEO IS DISPLAYED THROUGH SET

- Source : VIDEO-CD DISC
- Display :TV monitor

| SET MODE | TV SYSTEM | DISC | DISPLAY | REMARK |
|----------|-----------|------|---------|-----------|
| PAL | PAL | PAL | OK | PAL 50Hz |
| | | NTSC | OK | PAL 50Hz |
| | NTSC | PAL | NG | No sync |
| | | NTSC | NG | No sync |
| NTSC | PAL | PAL | NG | No color |
| | | NTSC | NG | No color |
| | NTSC | PAL | OK | |
| | | NTSC | OK | NTSC 60Hz |

* Color or sync is in trouble according to TV set.

PRECAUTIONS WHEN USING COMPACT DISCS

- Handle your compact discs with care. Always hold them by the edges to avoid leaving fingerprints on the shiny surface.
- When you have finished playing a compact disc, always put it back in its case. Do not fix paper or adhesive tape to the discs and do not write on the label.
- Clean them with a special-purpose cloth.
- Store your compact discs in a clean place, out of direct sunlight, where they will not be exposed to high temperatures.
- Always use compact discs marked .



SPECIFICATIONS

| | | | |
|------------------------|-------------|---------------|---|
| GENERAL SPECIFICATIONS | | | <ul style="list-style-type: none"> - Power consumption: 8W - Weight: 3.2 kg - Dimensions: Z-850 420 (W) x 341 (D) x 111 (H) mm Z-870 420 (W) x 334 (D) x 111 (H) mm Z-890 420 (W) x 339 (D) x 111 (H) mm - Operating temperature: +5°C~+35°C (41°F~95°F) |
| USABLE Media | | | NTSC/PAL |
| CD | 12cm | single | 74 min |
| | 8 cm | single | 20 min |
| VCD | 12cm single | Audio + Video | 74 min |
| MP3 | 12Cm | singl | <ul style="list-style-type: none"> - Format that can be played back: MPEG1 LAYER3 - Sampling frequency: 44.1KHz - File extension name: .MP3 |
| VIDEO OUTPUT | | | - Output level: 1Vp-p (for 75 ohm load) 1channel |
| AUDIO OUTPUT | | | <ul style="list-style-type: none"> - 2 Channels (L/R) - Output1 level: 2 Vrms (1KHz, 0 dB) - Output2 level: 0.5 Vrms (1KHz, 0 dB) - Audio characteristics: frequency response: 20Hz-20KHz Signal to Noise: 85dB total harmonic distortion: 0.1%(at 1KHz, 0dB) |



AH68-01166B