

SAMSUNG

COLOUR TELEVISION

Owner's Instructions

Before operating the unit,
please read this manual thoroughly,
and retain it for future reference.

**ON-SCREEN MENUS
PICTURE IN PICTURE
DNle Jr
(Digital Natural Image engine Junior)
TELETEXT (OPTION)**

Contents

◆ CONNECTING AND PREPARING YOUR TELEVISION	
■ Control Panels (depending on the model)	5
■ Connection Panels (depending on the model)	6
■ Infrared Remote Control	8
■ Inserting the Batteries in the Remote Control.....	9
■ Connecting to an Aerial or Cable Television Network	10
■ Switching Your Television On and Off.....	11
■ Placing Your Television in Standby Mode	11
■ Becoming Familiar with the Remote Control	12
■ Plug & Play Feature (depending on the model).....	13
■ Viewing the Demonstration.....	14
■ Choosing Your Language.....	14
◆ SETTING THE CHANNELS	
■ Storing Channels Automatically.....	15
■ Storing Channels Manually.....	16
■ Skipping Unwanted Channels	18
■ Sorting the Stored Channels	19
◆ USING YOUR TELEVISION	
■ Changing the Picture Standard	20
■ Adjusting the Picture Settings.....	21
■ Selecting the Picture Size.....	22
■ Extra Picture Settings	23
■ Using the Tilt Control Feature (depending on the model).....	24
■ Setting the Blue Screen.....	24
■ Changing the Sound Standard	25
■ Adjusting the Sound Settings	26
■ Extra Sound Settings (depending on the model).....	27
■ Selecting the Melody	28
■ Selecting the Sound Mode (depending on the model)	29
■ Setting and Displaying the Current Time.....	30
■ Setting the Sleep Timer	31
■ Switching the Television On and Off Automatically	32
■ Setting the Preferred Volume Level.....	33
■ Using the LNA (Low Noise Amplifier) feature (depending on the model)	34
■ Activating the Child Lock	35
■ Viewing an External Signal Source (depending on the model)	36
■ Viewing the Picture In Picture (PIP) (depending on the model)	37

Contents (continued)

◆ USING THE TELETEXT FEATURE (depending on the model)	
■ Teletext Feature (depending on the model)	40
■ Displaying the Teletext Information (depending on the model)	40
■ Selecting a Page by Number (depending on the model)	41
■ Using FLOF to Select a Page (depending on the model)	42
■ Storing Teletext Pages (depending on the model)	42
◆ ADDITIONAL INFORMATION ON CONNECTIONS	
■ Connecting to the AV-1 or 2 Input/Outputs	43
■ Connecting to the S-VIDEO Input (depending on the model)	43
■ Connecting to the DVD Input (depending on the model)	44
■ Connecting to the RCA Input (depending on the model)	44
■ Connecting to the Audio Output (depending on the model)	44
■ Connecting Headphones (depending on the model)	45
■ Viewing Pictures From External Sources (depending on the model)	45
◆ RECOMMENDATIONS FOR USE	
■ Automatic Degaussing to Remove Colour Patches	46
■ Troubleshooting: Before Contacting Service Personnel	46

Symbols



Press



Important



Note

Control Panels (depending on the model)

➤ The actual configuration on your TV may be different, depending on your model.

ENG

Front of the TV

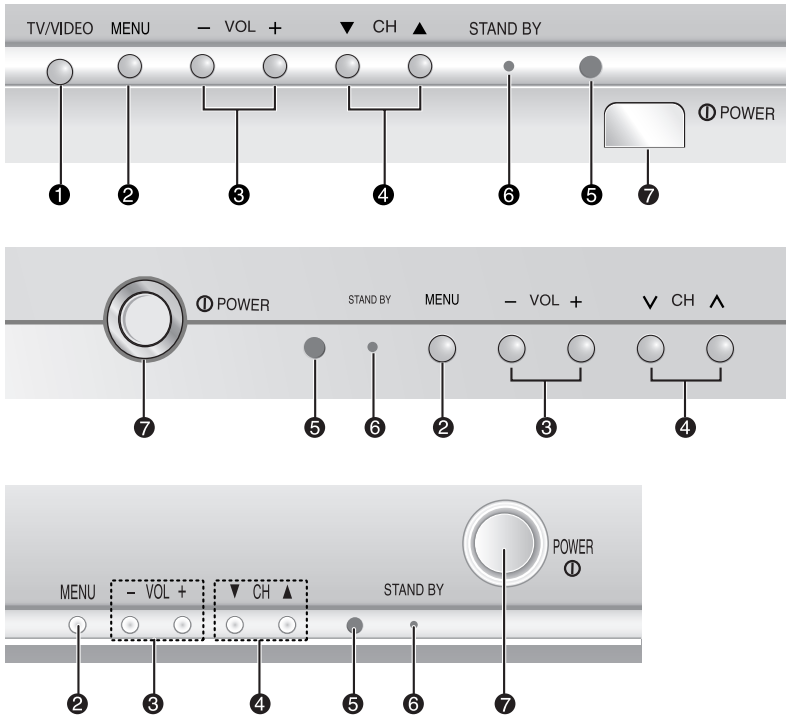

- | | |
|---------------------------|--------------------------|
| 1) Input source selection | 5) Remote control sensor |
| 2) Menu display | 6) Standby indicator |
| 3) Volume adjustment | 7) Power On/Off |
| 4) Channel selection | |

➤ Using the Buttons on the Panel

If the remote control no longer works or you have lost it, you can use controls on the panel of the TV to:

- ◆ Switch on the TV when it is in Standby mode and select channels (▼ CH ▲ or ▼ CH ▲).
- ◆ Access the menu (**MENU**).
- ◆ Adjust the volume (- VOL +).
- ◆ Switch among Video input modes (**TV/VIDEO**).

Connection Panels (depending on the model)

ENG

➤ This figure shows the Standard Connector-jack panel.
The actual configuration on your TV may be different, depending on the model.

Side of TV

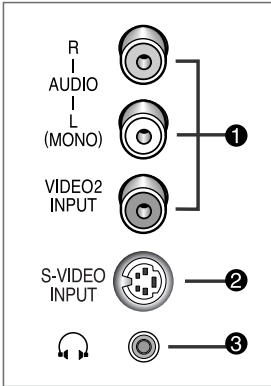

Front of TV

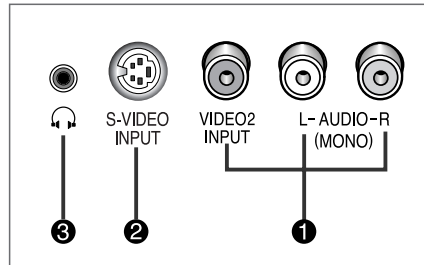

1 CONNECTING EXTERNAL A/V DEVICES (INPUT)

The RCA (VIDEO + AUDIO-L and R) connectors are used for equipment such as camcorders, video disc players and some video game devices.

- ◆ When both the side (or front) and rear connectors are connected to external equipment, the side (or front) AV has the priority.
- ◆ When using the mono equipment such as camcorders, video disc players and some video game devices, connect to the “AUDIO-L” input connector.

2 CONNECTING EXTERNAL S-VIDEO DEVICES (INPUT) (Option)

– Video and audio inputs for external devices with an S-Video output, such as a camcorder or VCR.

3 CONNECTING HEADPHONES (Option)

- You can connect a set of headphones to your television if you wish to watch a television programme without disturbing the other people in the room.
- Prolonged use of headphones at a high volume may damage your hearing.

👉 Whenever you connect an audio or video system to your television, ensure that all elements are switched off.

Refer to the documentation supplied with your equipment for detailed connection instructions and associated safety precautions.

Rear of TV

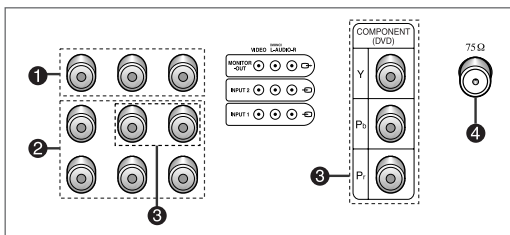
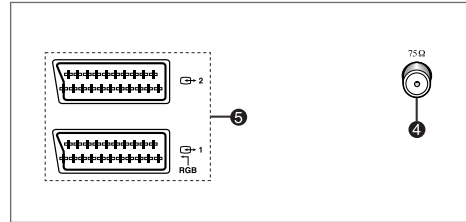
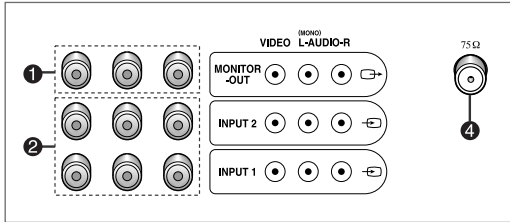

1 MONITOR OUT (VIDEO / L-AUDIO-R)
Outputs for external devices.

**2 AV 1 (VCR) -VIDEO/AUDIO(L/R)
AV 2 (VCR) -VIDEO/L-AUDIO-R**
Inputs or outputs for external devices, such as VCR, DVD, video game device or video disc players.

3 COMPONENT (DVD)
VIDEO (Y/P_b/P_r) and AUDIO (L/R) inputs for Component.

4 VHF/UHF (75Ω)
75Ω Coaxial connector for Aerial/ Cable Network.

5 5-1 / 5-2 (SCART)
Inputs or outputs for external devices, such as VCR, DVD, video game device or video disc players.

➤ Available format for Component Inputs : 480i

➤ When using the mono equipment such as camcorders, video disc players and some video game device, connect to the "AUDIO-L" input connector.

Infrared Remote Control

ENG

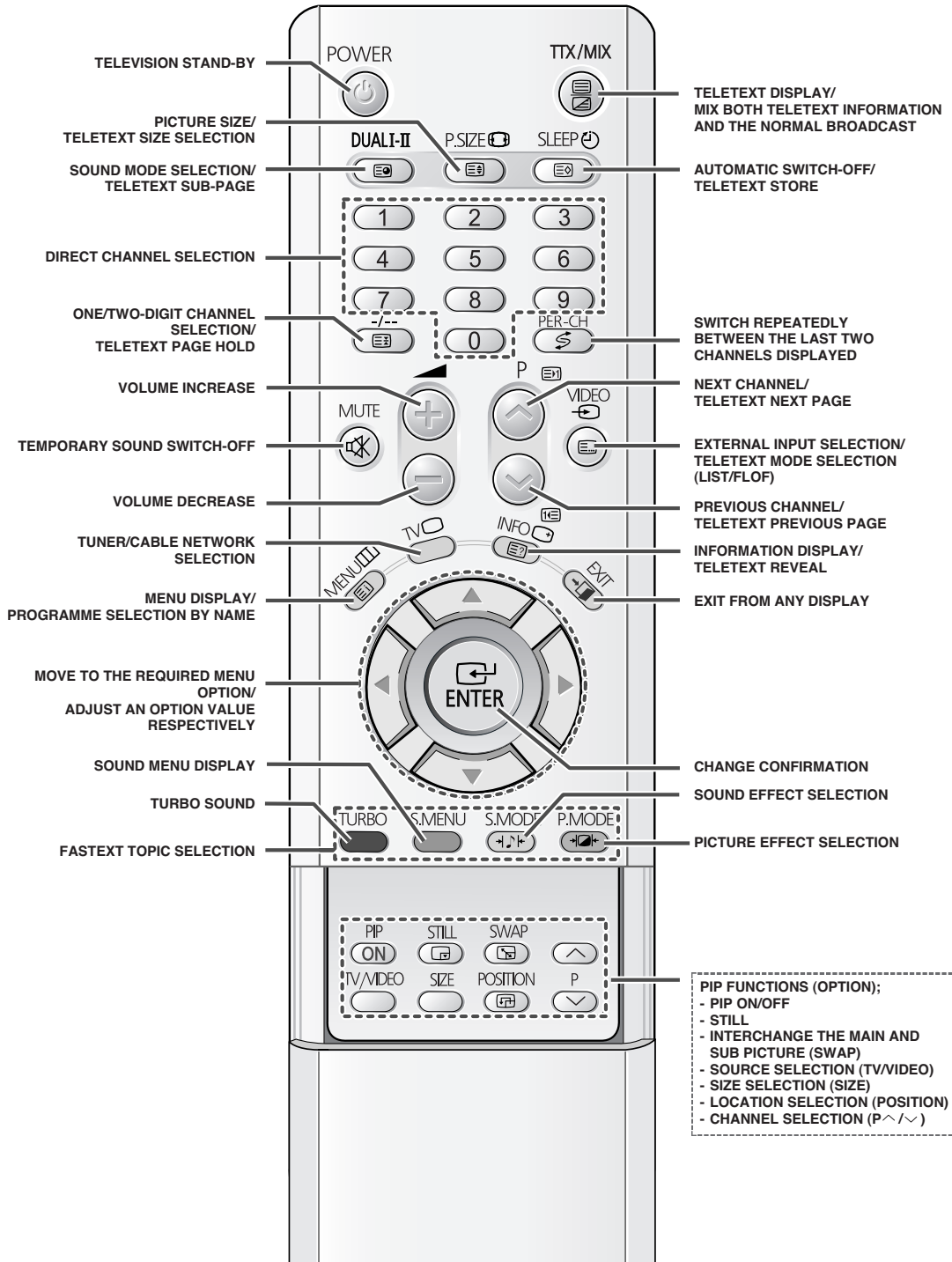

➤ The performance of the remote control may be affected by bright light.

Inserting the Batteries in the Remote Control

You must insert or replace the batteries in the remote control when you:

- ◆ *Purchase the television*
- ◆ *Find that the remote control is no longer operating correctly*

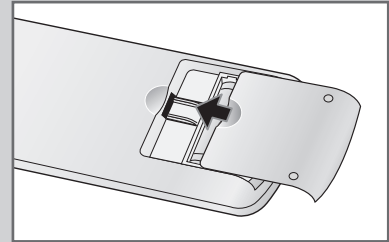
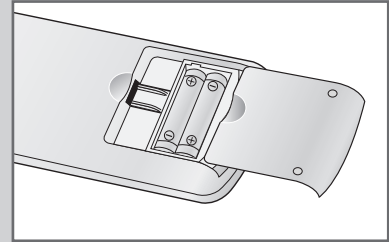
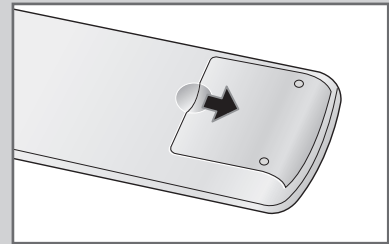

- 1** Remove the cover on the rear of the remote control by pressing the symbol (▼) downwards and then pulling firmly to remove it.
- 2** Insert two R03, UM4, "AAA" 1.5V or equivalent batteries taking care to respect the polarities:
 - ◆ - on the battery against - on the remote control
 - ◆ + on the battery against + on the remote control
- 3** Replace the cover by aligning it with the base of the remote control and pressing it back into place.

Connecting to an Aerial or Cable Television Network

ENG

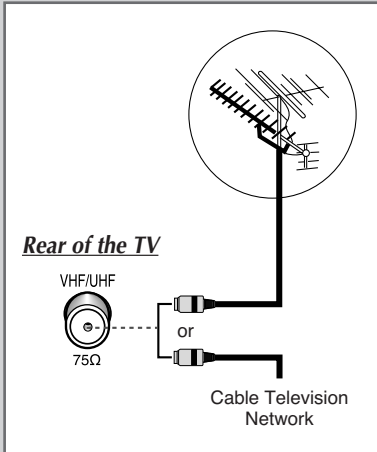



To view television channels correctly, a signal must be received by the set from one of the following sources:

- ◆ An outdoor aerial
- ◆ A cable television network
- ◆ A satellite network

- 1 In the first three cases, connect the aerial or network input cable to the 75Ω coaxial socket on the rear of the television.
- 2 If you are using an indoor aerial, you may need to turn it when tuning your television until you obtain a picture that is both sharp and clear.
For further details, refer to:
 - ◆ “Storing Channels Automatically” on page 15.
 - ◆ “Storing Channels Manually” on page 16.

➤ Signal Strength () display (Option)

The “  ”(Signal Strength) symbol is displayed by pressing the “INFO ()” button. This symbol displays signal strength for your watching TV channel. The more signal bar is the better TV gets sensitivity on current channel.

Switching Your Television On and Off

The mains lead is attached to the rear of your television.

- 1 Plug the mains lead into an appropriate socket.
 - The main voltage is indicated on the rear of the television and the frequency is 50 or 60Hz.

- 2 Press the “⏻” button (On/Off) on the front of the television.

Result: The Standby indicator on the front of the television lights up.

- 3 Press the **POWER** (⏻) button on the remote control to switch the television on.

Result: The programme that you were watching last is re-selected automatically.

 - If you have not yet stored any channels, No clear picture appears. Refer to “Storing Channels Automatically” on page 15 or “Storing Channels Manually” on page 16.

- 4 To switch your television off, press the “⏻” button (On/Off) again.

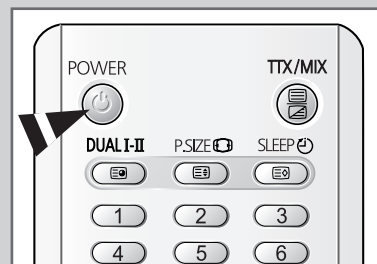

Placing Your Television in Standby Mode

Your television can be placed in Standby mode, in order to reduce:

- ◆ *Power consumption*
- ◆ *Wear of the cathode ray tube*

The Standby mode can be useful when you wish to interrupt viewing temporarily (during a meal, for example).

- 1 Press the **POWER** (⏻) button on the remote control.

Result: The screen is turned off and the Standby indicator on the front of the television lights up in red.

- 2 To switch the television back on, simply press the **POWER** (⏻) button again.
 - You can also switch on by pressing the **P** (⏻) or (⏻) button.

- ☞ Do not leave your television in Standby mode for long periods of time (when you are away on holiday, for example). Turn your television off by pressing the “⏻” button (On/Off) on the front of the television. It is best to unplug the set from the mains and aerial.

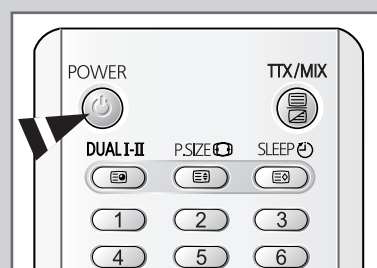

Becoming Familiar with the Remote Control

ENG

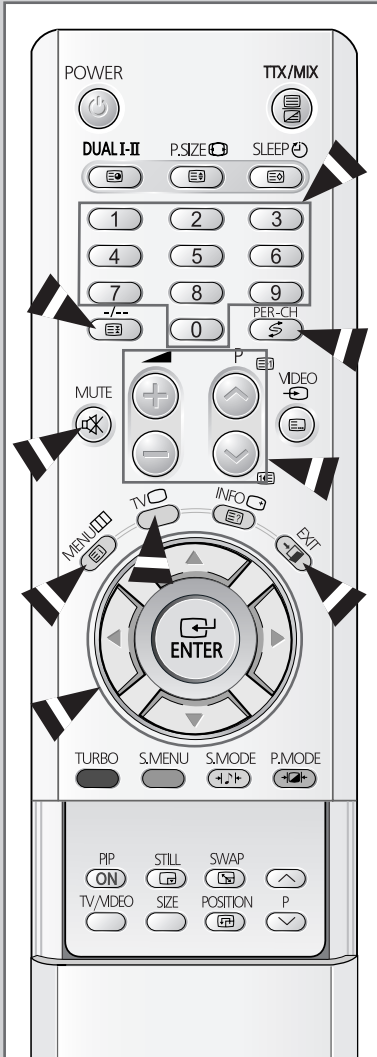

The remote control is used mainly to:

- ◆ Change channels and adjust the volume
- ◆ Set up the television using the on-screen menu system

The following table presents the most frequently used buttons and their functions.

Button	Viewing Function	Menu Function
	Used to display the next stored channel.	-
	Used to display the previous stored channel.	-
	Used to display the corresponding channels.	-
	Used to select a channel numbered ten or over. Press this button, and the "--" symbol is displayed. Enter the two-digit channel number.	-
PRE-CH	Press the PRE-CH button. The TV will switch to the last channel viewed. To quickly switch between two channels that are far apart, tune to one channel, then use the number button to select second channel. Then, use the PRE-CH button to quickly alternate between them.	-
	Used to increase the volume.	-
	Used to decrease the volume.	-
MUTE	Used to switch the sound off temporarily. To turn the sound back on, press this button again, or press the or button.	-
MENU	Used to display the on-screen menu system.	Used to return to the previous menu or normal viewing.
	-	Used to: ◆ Display a submenu containing selections for the current menu option ◆ Increase/decrease a menu option value
	-	Used to confirm your choice.
EXIT	-	Used to exit from the menu system and return to normal viewing directly.
TV	◆ Used to return the TV mode when it is in external input mode.	-

Plug & Play Feature (depending on the model)

ENG

When the television is initially powered on, three basic customer settings proceed automatically and subsequently: setting the language, channel and clock.

- 1 If the television is in Standby mode, press the **POWER** (⏻) button on the remote control.

Result: The message **Plug & Play** is displayed. It flickers for a little while and then **Language** menu is automatically displayed.

- 2 Select the appropriate language by pressing the ▼ or ▲ button. Press the **ENTER** (↵) button to enter the language.

Result: The message **Check antenna input.** is displayed.

- If any language is not selected on the **Language** menu, the **Language** menu will disappear about 30 seconds later.

- 3 Make sure that the antenna is connected to the TV. Press the **ENTER** (↵) button.

Result: The **Auto Store** menu is displayed with **Area** is selected.

- 4 Press the **ENTER** (↵) button again. Select your area by pressing the ▼ or ▲ button, and then Press the **ENTER** (↵) button. To search the channels, select **Search** by pressing the ▼ or ▲ button, and then press the **ENTER** (↵) button. Press the **ENTER** (↵) button again to start search the channels. Press the **MENU** (☰) button to stop the search.

Result: The **Time** menu is displayed with **Clock** is selected.

- Refer to “Storing Channels Automatically” on page 15.

- 5 Press the ◀ or ▶ button to move to the hour or minute. Set the hour or minute by pressing the ▼ or ▲ button.

- Refer to “Setting and Displaying the Current Time” on page 30.

- 6 When you have finished, press the **MENU** (☰) button.

Result: The message **Enjoy your watching** is displayed, and then the channel which has been stored will be activated.

- 7 **If you want to reset this feature...**

- 1 Press the **MENU** (☰) button.

- 2 Press the ▼ or ▲ button to select **Setup**, and then press the **ENTER** (↵) button.

Result: The **Plug & Play** is selected.

- 3 Press the **ENTER** (↵) button again.

Result: This feature starts with the message **Plug & Play** is displayed.

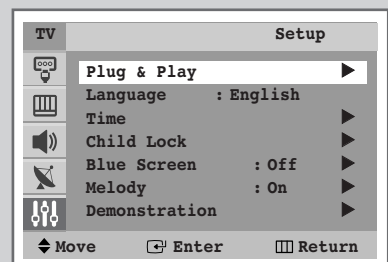
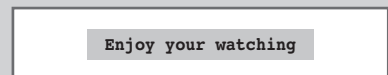
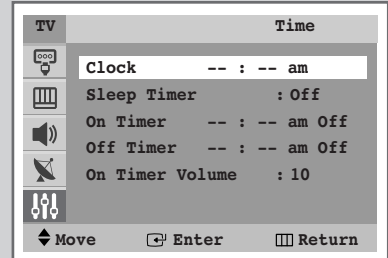
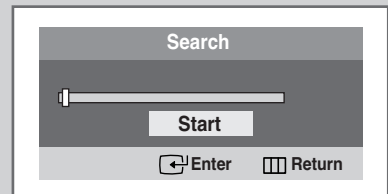
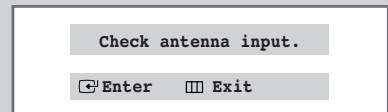
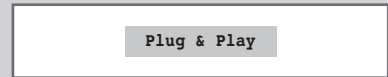

Viewing the Demonstration

ENG

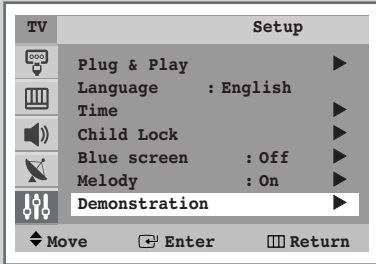

To become familiar with the various menus provided by your television, you can view the in built demonstration.

- 1 Press the **MENU** (□□) button.

Result: The main menu is displayed.

- 2 Press the ▼ or ▲ button to select **Setup**.

Result: The options available in the **Setup** group are displayed.

- 3 Press the **ENTER** (↵) button.

- 4 Press the ▼ or ▲ button to select **Demonstration**.

- 5 Press the **ENTER** (↵) button.

Result: Each of the menu options is displayed in turn.

➤ When you wish to exit from the demonstration, press the **EXIT** (→) button on the remote control.

Choosing Your Language

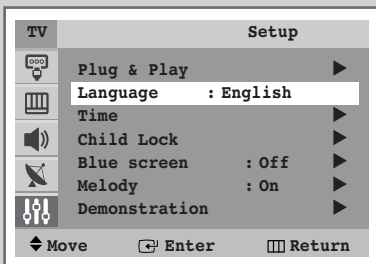

When you start using your television for the first time, you must select the language which will be used for displaying menus and indications.

- 1 Press the **MENU** (□□) button.

Result: The main menu is displayed.

- 2 Press the ▼ or ▲ button to select **Setup**.

Result: The options available in the **Setup** group are displayed.

- 3 Press the **ENTER** (↵) button.

- 4 Press the ▼ or ▲ button to select **Language**.

- 5 Select the appropriate language by pressing the **ENTER** (↵) button repeatedly.

Storing Channels Automatically

You can scan for the frequency ranges available to you (and availability depends on your country). Automatically allocated programme numbers may not correspond to actual or desired programme numbers. However you can sort numbers manually and clear any channels you do not wish to watch.

- 1 Press the **MENU** (□□□) button.

Result: The main menu is displayed.

- 2 Press the ▼ or ▲ button to select **Channel**.

Result: The options available in the **Channel** group are displayed.

- 3 Press the **ENTER** (↵) button.

Result: The **Auto Store** is selected.

- 4 Press the **ENTER** (↵) button again.

Result: The options available in the **Auto Store** group are displayed with **Area** is selected.

- 5 Press the **ENTER** (↵) button again.

- 6 Select your area by pressing the ▼ or ▲ button, then press the **ENTER** (↵) button.

The areas are displayed in the following order:

ASIA W/EUROPE - CIS E/EUROPE - CHINA - HONGKONG U/K - AUSTRALIA - NZ/INDONESIA - SOUTH AFRICA - AMERICA

- 7 Press the ▼ or ▲ button to select **Search**, then press the **ENTER** (↵) button.

- 8 Press the **ENTER** (↵) button to start the search.

Result: The horizontal bar is displayed, and then channels are stored in an order which reflects their positions in the frequency range. Finally, the search will end automatically.

➤ To stop the search before it has finished, press the **MENU** (□□□) button.

- 9 When searching and storing are complete, the **Sort** menu is displayed.

- ◆ To sort the stored channels into the desired numerical order, go to Step 6 of the "Sorting the Stored Channels" procedure on page 19.

- ◆ To exit from the channel store function without sorting the channels, press the **MENU** (□□□) button repeatedly until the menus disappear.

- 10 When the channels have been stored, you can:

- ◆ Sort them in the order required (refer to page 19)
- ◆ Clear a channel (refer to page 18)
- ◆ Activate the Digital Noise Reduction feature (refer to page 23)

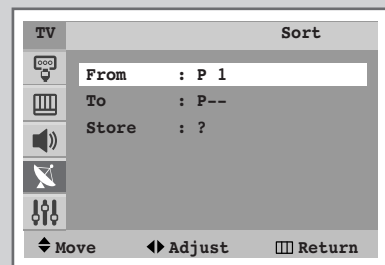
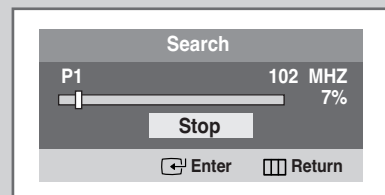
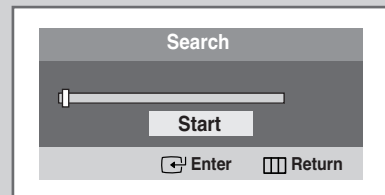
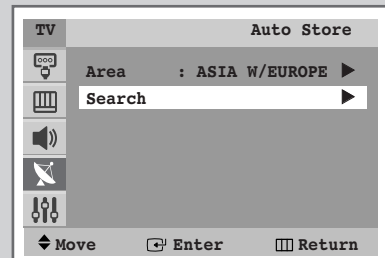
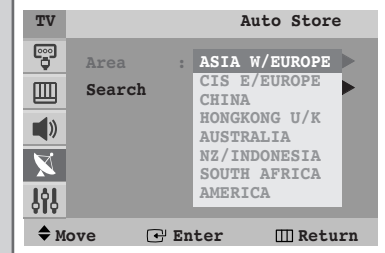
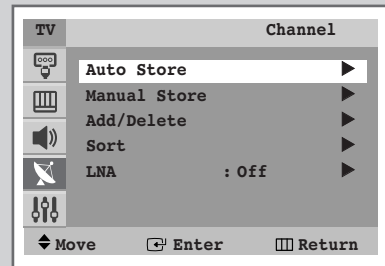

Storing Channels Manually

ENG

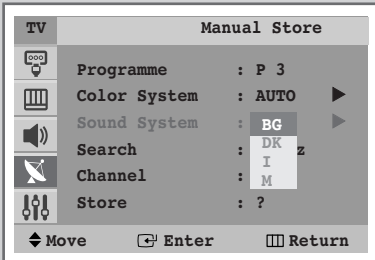
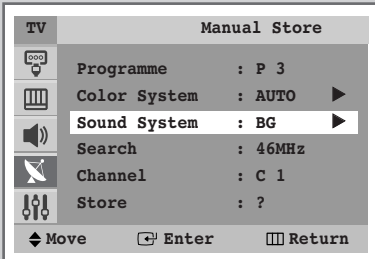
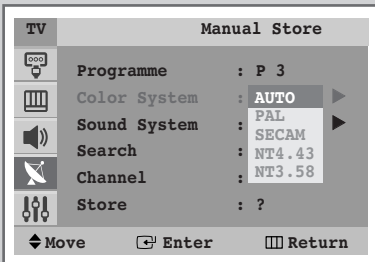
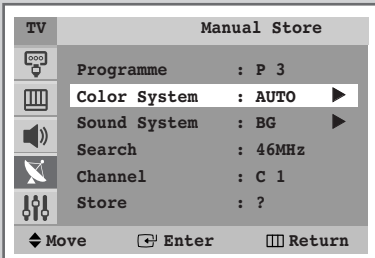
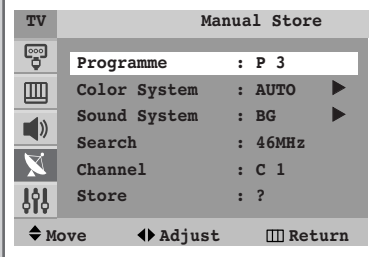
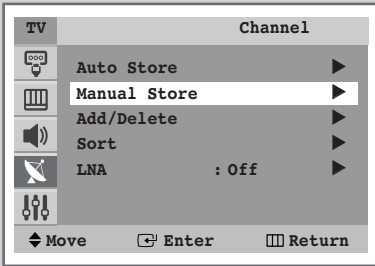

You can store the channels, including those received via cable networks.

When storing channels manually, you can choose:

- ◆ Whether or not to store each of the channels found
- ◆ The programme number of each stored channel which you wish to identify

- 1 Press the **MENU** (⏪) button.
Result: The main menu is displayed.
- 2 Press the **▼** or **▲** button to select **Channel1**.
- 3 Press the **ENTER** (⏎) button.
Result: The options available in the **Channel1** group are displayed.
- 4 Press the **▼** or **▲** button to select **Manual Store**.
- 5 Press the **ENTER** (⏎) button.
- 6 To assign a programme number to a channel, press the **◀** or **▶** button.
- 7 Press the **▼** or **▲** button to select **Color system**.
- 8 Press the **ENTER** (⏎) button.
- 9 Press the **▼** or **▲** button to select the broadcasting standards.
Result: The color standards are displayed in the following order:
AUTO - PAL - SECAM - NT4.43 - NT3.58.
- 10 Press the **ENTER** (⏎) button.
- 11 Press the **▼** or **▲** button to select **Sound System**.
- 12 Press the **ENTER** (⏎) button.
- 13 Press the **▼** or **▲** button to select the sound standards.
Result: The sound standards are displayed in the following order:
BG - DK - I - M.
- 14 Press the **ENTER** (⏎) button.

- 15** If you do not know the channel numbers, select **Search** by pressing the ▼ or ▲ button. Press the ◀ or ▶ button to start the search.

Result: The tuner scans the frequency range until the first channel or the channel that you selected is received on your screen.

- 16** If you know the number of the channel to be stored, see the following steps.

- ◆ Press the ▼ or ▲ button to select **Channel**.
- ◆ Press the ▶ button.
- ◆ Press the ▼ or ▲ button to select **C** (Air channel) or **S** (Cable channel).
- ◆ Press the ▶ button.
- ◆ Press the ▼ or ▲ button to select indicate the required number.
 - You can also select the channel number directly by pressing the numeric buttons (0~9).
- ◆ Press the **ENTER** (↵) button to select the required number.
 - If no sound or abnormal sound, re-select the sound standard required.

- 17** To store the channel and associated programme number, select **Store** by pressing the ▼ or ▲ button. Press the **ENTER** (↵) button to select **OK**.

- 18** Repeat Steps 16 to 17 for each channel to be stored.

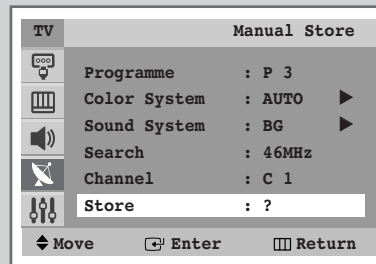
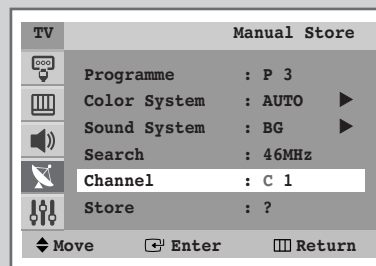
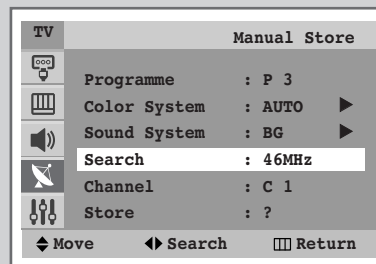

Channel mode

- ◆ **P** (Programme mode): When completing tuning, the broadcasting stations in your area have been assigned to position numbers from P00 to max P99. You can select a channel by entering the position number in this mode.
- ◆ **C** (Real channel mode): You can select a channel by entering the assigned number to each air broadcasting station in this mode.
- ◆ **S** (Cable channel mode): You can select a channel by entering the assigned number for each cable channel in this mode.

Skipping Unwanted Channels

ENG

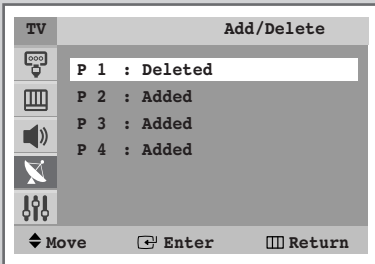
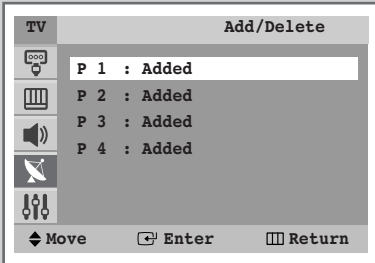
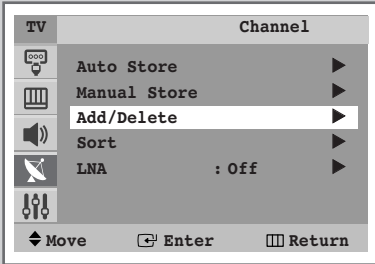

You can exclude the channels you chosen from the channels you scanned. When you scan through the stored channels, those you have chosen to skip are not displayed.

All of the channels that you do not specifically choose to skip are displayed during scanning.

- 1 Press the **MENU** (□□□) button.

Result: The main menu is displayed.

- 2 Press the ▼ or ▲ button to select **Channel1**.

Result: The options available in the **Channel1** group are displayed.

- 3 Press the **ENTER** (↵) button.

- 4 Press the ▼ or ▲ button to select **Add/Delete**.

- 5 Press the **ENTER** (↵) button.

Result: The stored channels are displayed.

- 6 Press the ▼ or ▲ button to select the channel to add or erase. If necessary, select **Added** or **Deleted** by pressing the **ENTER** (↵) button.

- 7 Repeat Step 6 for each channel to be added or erased.

Sorting the Stored Channels

This operation allows you to change the programme numbers of stored channels. This operation may be necessary after using auto store. You can delete the channels you do not want to keep.

- 1 Press the **MENU** (□□) button.
Result: The main menu is displayed.
- 2 Press the ▼ or ▲ button to select **Channel1**.
Result: The options available in the **Channel1** group are displayed.
- 3 Press the **ENTER** (↵) button.
- 4 Press the ▼ or ▲ button to select **Sort**.
- 5 Press the **ENTER** (↵) button.
Result: The options available in the **Sort** group are displayed with **From** is selected.
- 6 Select the channel number that you wish to change by pressing the ◀ or ▶ button repeatedly.
- 7 Press the ▼ or ▲ button to select **To**. Select the new channel number which you wish to identify by pressing the ◀ or ▶ button repeatedly.
➤ You can also select the channel number directly by pressing the numeric buttons (0~9).
- 8 Press the ▼ or ▲ button to select **Store**. Select **OK** to confirm the exchange of channel numbers by pressing the **ENTER** (↵) button.
Result: The selected channel is exchanged with the one previously stored to the chosen number.
- 9 For all the channels to move to the required channel numbers, repeat steps 6 to 8 after selecting the **From** by pressing the ▼ or ▲ button.

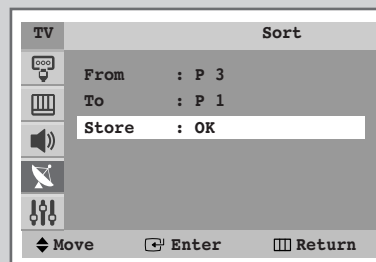
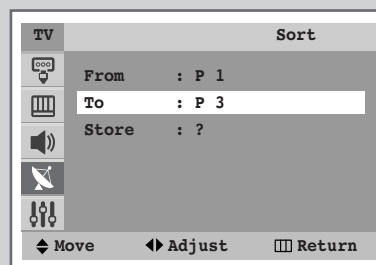
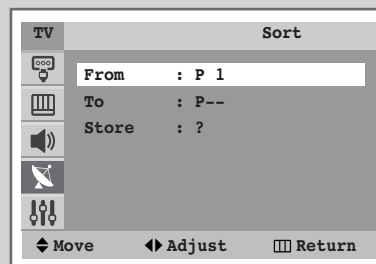
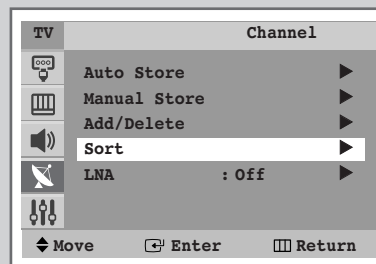

Changing the Picture Standard

ENG

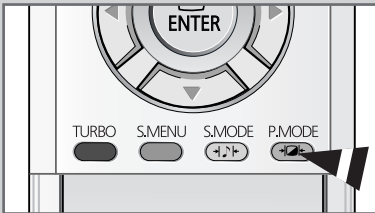
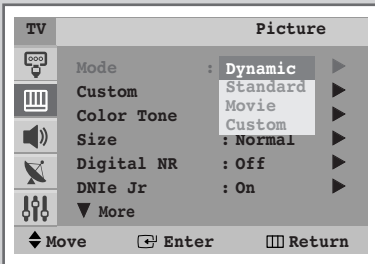
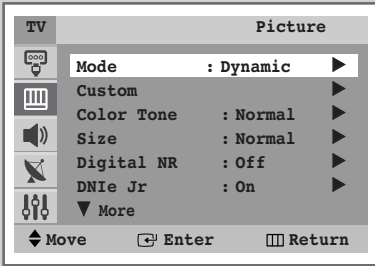

You can select the type of picture which best corresponds to your viewing requirements.

- 1 Press the **MENU** (□) button.
Result: The main menu is displayed.
- 2 Press the ▼ or ▲ button to select **Picture**.
Result: The options available in the **Picture** group are displayed.
- 3 Press the **ENTER** (↵) button.
- 4 Press the **ENTER** (↵) button again to select **Mode**.
Result: The options available in the **Mode** group are displayed.
- 5 Press the ▼ or ▲ button to select picture mode.
Result: The following picture effects are available:
Dynamic – Standard – Movie – Custom.
- 6 Press the **ENTER** (↵) button.

➤ You can also set these options simply by pressing the **P.MODE** (↵ : Picture Mode) button.

Adjusting the Picture Settings

Your television has several settings which allow you to control picture quality.

- 1 Press the **MENU** (□□□) button.
Result: The main menu is displayed.

- 2 Press the ▼ or ▲ button to select **Picture**.
Result: The options available in the **Picture** group are displayed.

- 3 Press the **ENTER** (↵) button.

- 4 Press the ▼ or ▲ button to select **Custom**.

- 5 Press the **ENTER** (↵) button.
Result: The options available in the **Custom** group are displayed.

- 6 Press the ▼ or ▲ button to select the option (**Contrast**, **Brightness**, **Sharpness**, **Color** or **Tint**-NTSC only) to be adjusted. Press the **ENTER** (↵) button.
Result: The horizontal bar is displayed. Move the horizontal bar's cursor left or right by pressing the ◀ or ▶ button.

- 7 Press the **EXIT** (→|) button.

Selecting the Color Tone

- 1 Press the **MENU** (□□□) button.
Result: The main menu is displayed.

- 2 Press the ▼ or ▲ button to select **Picture**.
Result: The options available in the **Picture** group are displayed.

- 3 Press the **ENTER** (↵) button.

- 4 Press the ▼ or ▲ button to select **Color Tone**.

- 5 Press the **ENTER** (↵) button.

- 6 Press the ▼ or ▲ button to select the required option (**Cool2**, **Cool1**, **Normal**, **Warm1** or **Warm2**).

- 7 Press the **ENTER** (↵) button.

- ◆ If you make any changes to these settings, the picture standard is automatically switched to **Custom**.
- ◆ The television has an "automatic degaussing" system that is activated if magnetic interference is present. To degauss the television screen, switch power off by pressing the "Ⓞ" (On/Off) button on the front panel. (Refer to "Automatic Degaussing to Remove Colour Patches" on page 46.)

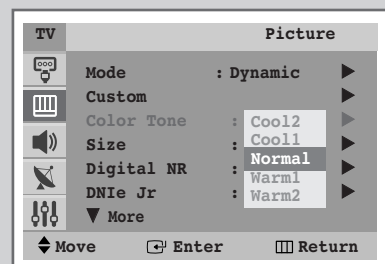
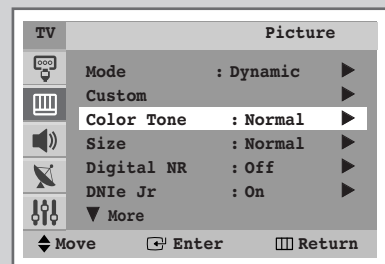
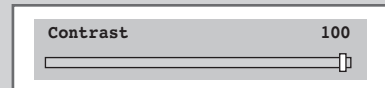
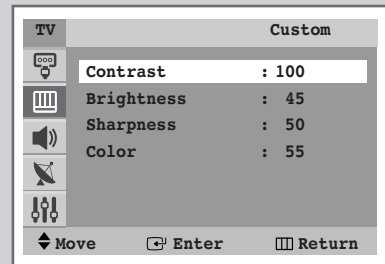
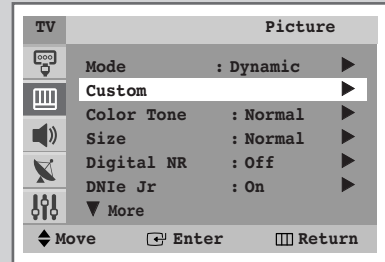

Selecting the Picture Size

ENG

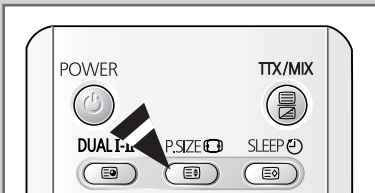
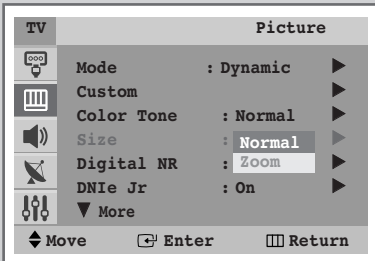
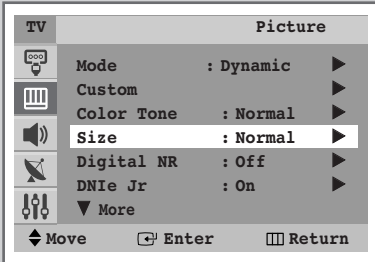

You can select the picture format which best corresponds to your viewing requirements. The following picture formats are available in the order given:

◆ **Normal, Zoom**

1 Press the **MENU** (□) button.

Result: The main menu is displayed.

2 Press the ▼ or ▲ button to select **Picture**.

Result: The options available in the **Picture** group are displayed.

3 Press the **ENTER** (↵) button.

4 Press the ▼ or ▲ button to select **Size**.

5 Press the **ENTER** (↵) button.

6 Press the ▼ or ▲ button to select the picture size (**Normal** or **Zoom**).

7 Press the **ENTER** (↵) button.

➤ You can select the required picture format by simply pressing the "P.SIZE (🖼)" (Picture Size) button on the remote control.

Extra Picture Settings

◆ Digital NR

If the signal received by your television is weak, you can activate this feature to reduce any static and ghosting that may appear on the screen.

- 1 Press the **MENU** (□□□) button.
Result: The main menu is displayed.
- 2 Press the ▼ or ▲ button to select **Picture**.
Result: The options available in the **Picture** group are displayed.
- 3 Press the **ENTER** (↵) button.
- 4 Press the ▼ or ▲ button to select **Digital NR**.
- 5 Press the **ENTER** (↵) button.
- 6 Press the ▼ or ▲ button to select **On**.
- 7 Press the **ENTER** (↵) button.

◆ DNie Jr (Digital Natural Image engine Junior) (Option)

This feature bring you more detailed image with detail enhancement, contrast enhancement and white enhancement. New image compensation Algorithm gives brighter, clearer, much detailed image to you. **DNie Jr** technology will fit every signals into your eyes.

- 1 Press the **MENU** (□□□) button.
Result: The main menu is displayed.
- 2 Press the ▼ or ▲ button to select **Picture**.
Result: The options available in the **Picture** group are displayed.
- 3 Press the **ENTER** (↵) button.
- 4 Press the ▼ or ▲ button to select **DNie Jr**.
- 5 Press the **ENTER** (↵) button.
- 6 Press the ◀ or ▶ button to select **On**.
- 7 Press the **ENTER** (↵) button.

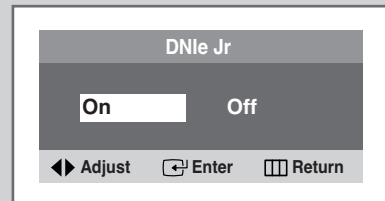
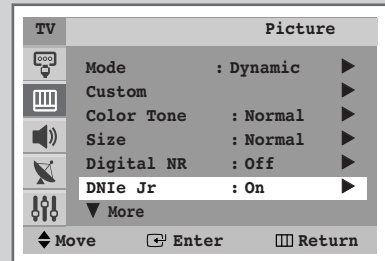
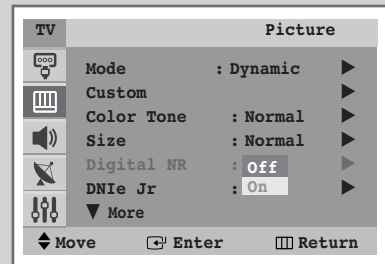
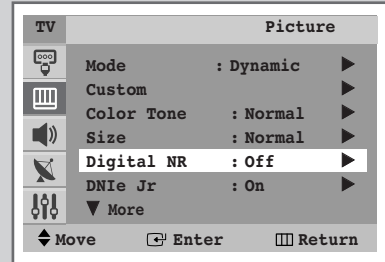

Using the Tilt Control Feature (depending on the model)

ENG

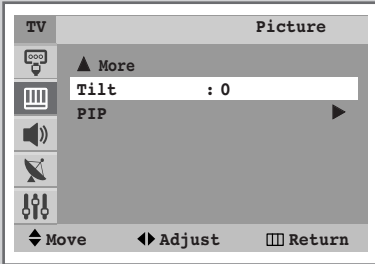

If you find that the picture received is slightly tilted to one side, you can adjust the tilt setting.

- 1 Press the **MENU** (□□) button.
Result: The main menu is displayed.
- 2 Press the ▼ or ▲ button to select **Picture**.
Result: The options available in the **Picture** group are displayed.
- 3 Press the **ENTER** (↵) button.
- 4 Press the ▼ or ▲ button to select **Tilt**.
- 5 Press the ◀ or ▶ button to reach the required setting (-7 to +7).

Setting the Blue Screen

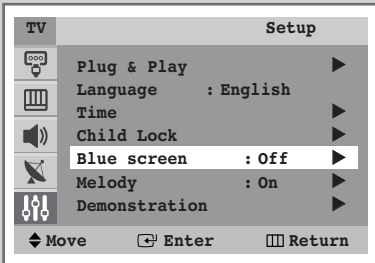

If no signal is being received or the signal is very weak, a blue screen automatically replaces the noisy picture background.

If you wish to continue viewing the poor picture, you must set the "Blue Screen" mode to "Off".

- 1 Press the **MENU** (□□) button.
Result: The main menu is displayed.
- 2 Press the ▼ or ▲ button to select **Setup**.
Result: The options available in the **Setup** group are displayed.
- 3 Press the **ENTER** (↵) button.
- 4 Press the ▼ or ▲ button to select **Blue screen**.
- 5 Press the **ENTER** (↵) button.
- 6 Press the ▼ or ▲ button to select **On**.
- 7 Press the **ENTER** (↵) button.

Changing the Sound Standard

You can select the type of special sound effect to be used when watching a given broadcast.

- 1 Press the **MENU** () button.
Result: The main menu is displayed.

- 2 Press the **▼** or **▲** button to select **Sound**.
Result: The options available in the **Sound** group are displayed.

- 3 Press the **ENTER** () button.

- 4 Press the **ENTER** () button again to select **Mode**.
Result: The options available in the **Mode** group are displayed.

- 5 Press the **▼** or **▲** button to select sound mode.
Result: The following sound effects are available:
Standard - Music - Movie - Speech(SVE) - Custom.
◆ SVE : SAMSUNG Voice Enhancement Technic

- 6 Press the **ENTER** () button.

➤ You can also set these options simply by pressing the **S.MODE** ( : Sound Mode) button.

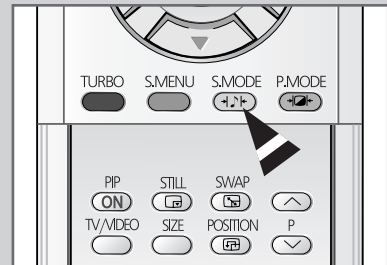
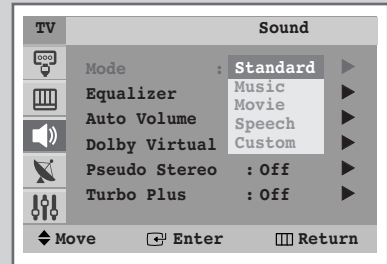
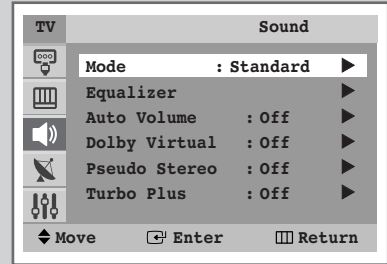

Adjusting the Sound Settings

ENG

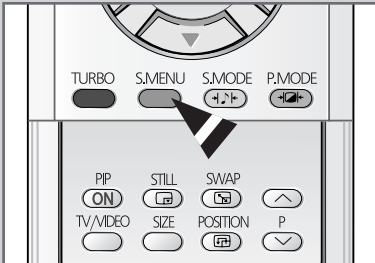
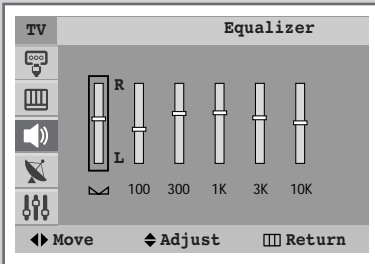
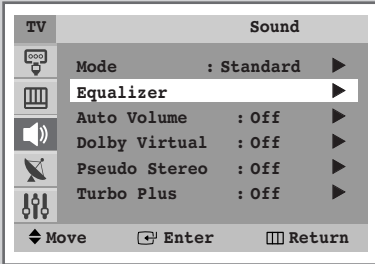

The sound settings can be adjusted to suit your personal preferences.

- 1 Press the **MENU** (□) button.
Result: The main menu is displayed.
- 2 Press the ▼ or ▲ button to select **Sound**.
Result: The options available in the **Sound** group are displayed.
- 3 Press the **ENTER** (↵) button.
- 4 Press the ▼ or ▲ button to select **Equalizer**.
- 5 Press the **ENTER** (↵) button.
Result: The options available in the **Equalizer** group are displayed.
➤ You can also display this group simply by pressing the **S.MENU** (Sound Menu) button.
- 6 Select the option to be adjusted by pressing the ◀ or ▶ button. Press the ▼ or ▲ button to reach the required setting.

➤ If you make any changes to these settings, the sound standard is automatically switched to **Custom**.

Extra Sound Settings (depending on the model)

ENG

◆ Auto Volume

Each broadcasting station has its own signal conditions, and so it is not easy for you to adjust the volume every time the channel is changed. This feature lets you automatically adjust the volume of the desired channel by lowering the sound output when the modulation signal is high or by raising the sound output when the modulation signal is low.

◆ Pseudo Stereo / Dolby Virtual (Option)

Pseudo stereo/Dolby Virtual (Option) feature converts a monaural sound signal into two identical left and right channels.

Once the **Pseudo stereo/Dolby Virtual** (Option) is set to **On** or **Off**, these settings apply to the sound effects such as **Standard**, **Music**, **Movie**, and **Speech (SVE)**.

◆ Turbo Plus

This feature suitably emphasizes both higher and lower bands of sound (and includes other effects). You can enjoy more magnificent and dynamic sound when watching music, movie or other channels.

- 1 Press the **MENU** (□) button.
Result: The main menu is displayed.
- 2 Press the **▼** or **▲** button to select **Sound**.
Result: The options available in the **Sound** group are displayed.
- 3 Press the **ENTER** (↵) button.
- 4 Select the required option (**Auto Volume**, **Dolby Virtual**, **Pseudo Stereo** or **Turbo Plus**) by pressing the **▼** or **▲** button. Press the **ENTER** (↵) button.

➤ You can select the turbo sound feature simply by pressing the **TURBO** button.
- 5 To activate each feature, select **On** by pressing the **▼** or **▲** button.
- 6 Press the **ENTER** (↵) button.

- Manufactured under license from Dolby Laboratories. "Dolby" and the double-D symbol are trademarks of Dolby Laboratories.

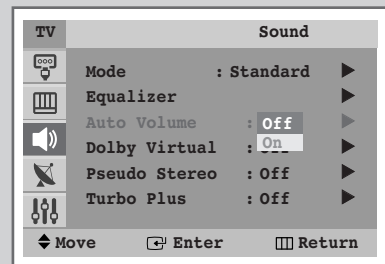
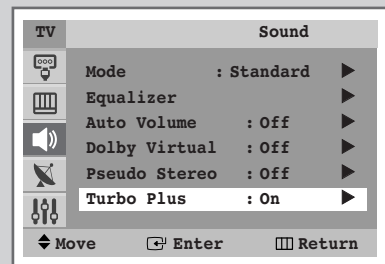
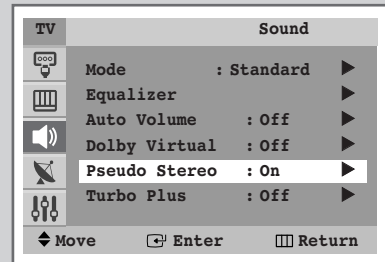
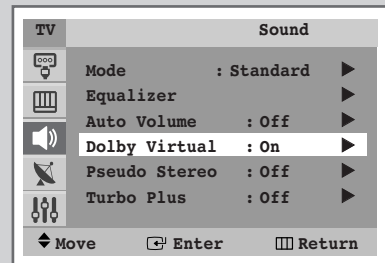
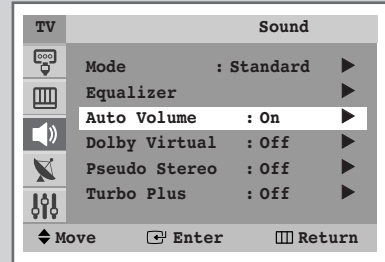

Selecting the Melody

ENG

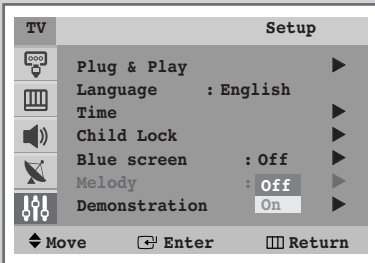
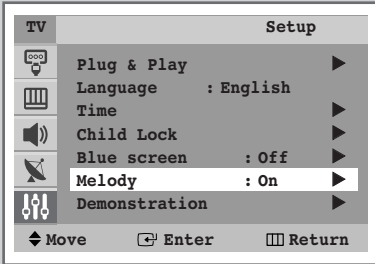

You can hear clear melody sound when the television is powered on or off.

1 Press the **MENU** (□□) button.

Result: The main menu is displayed.

2 Press the ▼ or ▲ button to select **Setup**.

Result: The options available in the **Setup** group are displayed.

3 Press the **ENTER** (↵) button.

4 Press the ▼ or ▲ button to select **Melody**.

5 Press the **ENTER** (↵) button.

6 Press the ▼ or ▲ button to select **On** (activating) or **Off**.

7 Press the **ENTER** (↵) button.

Setting and Displaying the Current Time

ENG

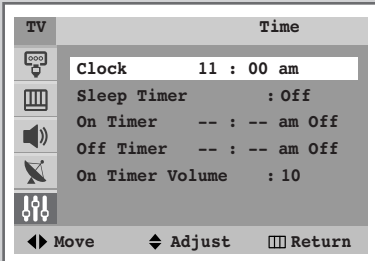
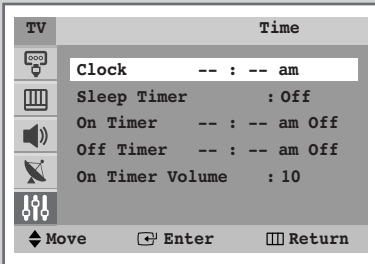
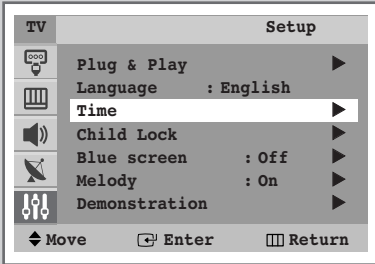

You can set the television's clock so that the current time is displayed by pressing the "INFO ()" button. You must also set the time if you wish to use the automatic on or off timers.

➤ When pressing the "Ⓜ" button (On/Off) on the front of the television, the clock setting will be reset.

- 1 Press the **MENU** () button.
Result: The main menu is displayed.

- 2 Press the ▼ or ▲ button to select **Setup**.
Result: The options available in the **Setup** group are displayed.

- 3 Press the **ENTER** () button.

- 4 Press the ▼ or ▲ button to select **Time**.

- 5 Press the **ENTER** () button.
Result: The **Time** is selected.

- 6 Press the **ENTER** () button again.
Result: The **Clock** is selected.

- 7 Press the ◀ or ▶ button to move to the hour or minute. Set the hour or minute by pressing the ▼ or ▲ button.

- 8 Press the **ENTER** () button.

- 9 When you have finished, press the **EXIT** () button to exit.

- 10 Press the **INFO** () button to display the channel information and the current time.

Setting the Sleep Timer

You can set your TV to automatically turn off after a preset interval.

- 1 Press the **MENU** (☰) button.
Result: The main menu is displayed.
- 2 Press the **▼** or **▲** button to select **Setup**.
Result: The options available in the **Setup** group are displayed.
- 3 Press the **ENTER** (↵) button.
- 4 Press the **▼** or **▲** button to select **Time**.
- 5 Press the **ENTER** (↵) button.
Result: The **Time** is selected.
- 6 Press the **▼** or **▲** button to select **Sleep Timer**.
- 7 Select the preset time interval (Off, 30, 60, 90, 120, 150, 180) for staying on by pressing the **◀** or **▶** button.
- 8 Press the **EXIT** (→) button.

➤ You can select a time period of between 30 and 180 minutes after the television automatically switches to Standby mode by pressing the **SLEEP** (⌚) button.

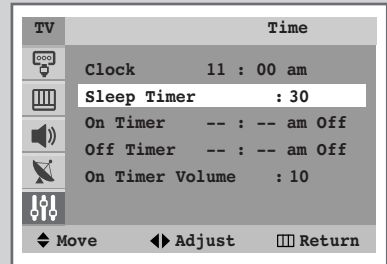
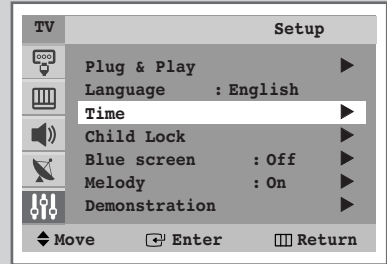

Switching the Television On and Off Automatically

ENG

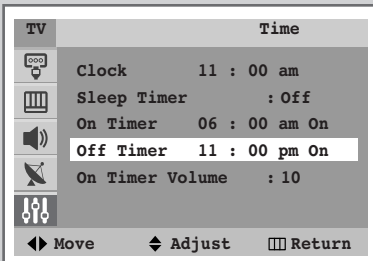
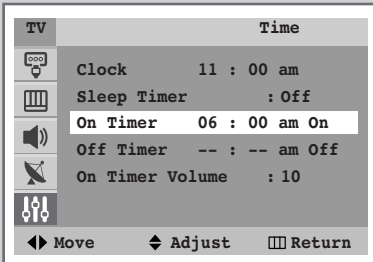
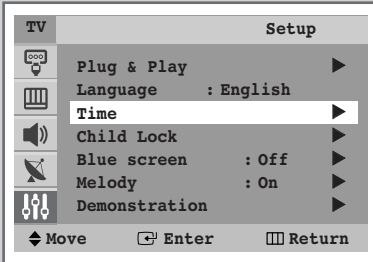

You can set the On/Off timers so that the television will:

- ◆ Switch on automatically and tune to the channel of your choice at the time you select
- ◆ Switch off automatically at the time you select

➤ The first step is to set the television's clock (refer to "Setting and Displaying the Current Time" on the page 30). If you have not yet set the clock, the message **Set the clock first** is displayed.

- 1 Press the **MENU** (□) button.
Result: The main menu is displayed.
- 2 Press the ▼ or ▲ button to select **Setup**.
Result: The options available in the **Setup** group are displayed.
- 3 Press the **ENTER** (↵) button.
- 4 Press the ▼ or ▲ button to select **Time**.
- 5 Press the **ENTER** (↵) button.
Result: The **Time** is selected.
- 6 Press the ▼ or ▲ button to select **On Timer**. Set the time at which you wish the television to be switched on automatically.
 - ◆ Press the ◀ or ▶ button to move to the hour or minute. Set these by pressing the ▼ or ▲ button.
 - ◆ Press the ◀ or ▶ button to move **Off** and then, press the ▼ or ▲ button to select **On** and press the **ENTER** (↵) button.
- 7 Press the ▼ or ▲ button to select **Off Timer**. In the same above, set the time at which you wish the television to be switched off automatically.

➤ Absent Power Off

When you set the timer "On", your television will eventually be turned off, if you do not operate any controls during the 3 hours after the TV is turned on by timer. This function is available in only the timer "On" mode and will prevent a leakage accident or overheating, caused by your TV left on for a long time due to the timer "On" (when you are away on holiday, for example).

Setting the Preferred Volume Level

The preferred volume can be set for when the timer automatically turns on the TV.

1 Press the **MENU** (□□) button.

Result: The main menu is displayed.

2 Press the ▼ or ▲ button to select **Setup**.

Result: The options available in the **Setup** group are displayed.

3 Press the **ENTER** (↵) button.

4 Press the ▼ or ▲ button to select **Time**

5 Press the **ENTER** (↵) button.

Result: The **Time** is selected.

6 Press the ▼ or ▲ button to select **On Timer Volume**.

7 Press the ◀ or ▶ button to adjust volume level.

8 When you have finished, press the **EXIT** (→) button.

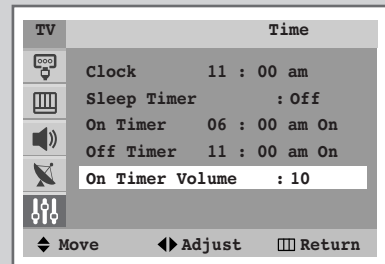
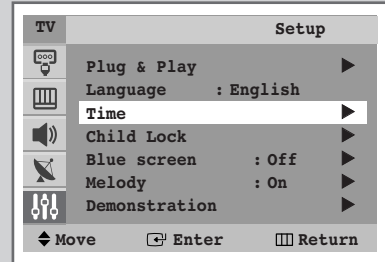

Using the LNA (Low Noise Amplifier) feature (depending on the model)

ENG

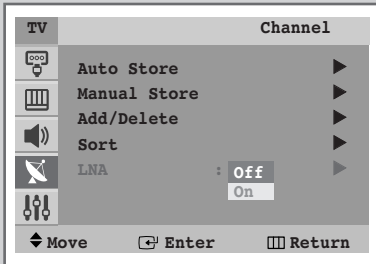
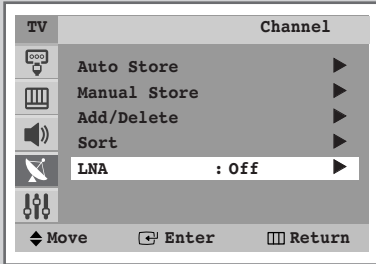

This function is very useful in the situation that the TV is used in weak signal. LNA amplifies the TV signal in the weak signal area, but not noise. This feature is working only weak signal condition, and that is memorized on current channel, additional.

1 Press the **MENU** (□□) button.

Result: The main menu is displayed.

2 Press the ▼ or ▲ button to select **Channel1**.

Result: The options available in the **Channel1** group are displayed.

3 Press the **ENTER** (↵) button.

4 Press the ▼ or ▲ button to select **LNA**.

5 Press the **ENTER** (↵) button.

6 Press the ▼ or ▲ button to select **On**.

7 Press the **ENTER** (↵) button.

Activating the Child Lock

You can restrict viewing by locking the channels of your choice.

Example: You can prevent your children from watching unsuitable programmes.

- 1 Press the **MENU** (□□□) button.
Result: The main menu is displayed.
- 2 Press the ▼ or ▲ button to select **Setup**.
Result: The options available in the **Setup** group are displayed.
- 3 Press the **ENTER** (↵) button.
- 4 Press the ▼ or ▲ button to select the **Child Lock**. Press the **ENTER** (↵) button.
- 5 Press the **ENTER** (↵) button again.
- 6 Press the ▼ or ▲ button to select the **On**.
Result: The **Child Lock** menu is displayed.
➤ If you want to unlock a channel, set to **Off**.
- 7 Press the **ENTER** (↵) button.
- 8 Press the ▼ or ▲ button to select the **Programme**. Select the number of the channel to be locked by pressing the ◀ or ▶ button.
- 9 Press the ▼ or ▲ button to select the **Lock**.
- 10 Press the **ENTER** (↵) button.
Result: **Locked** is displayed.
- 11 When you have finished, press the **EXIT** (⏻) or **MENU** (□□□) button repeatedly to return to normal viewing.

➤ If any channel is locked, you can not enter the **Channel** menu by using the control buttons on the television, and the message "Not available" is displayed. You can access by using the remote control only.

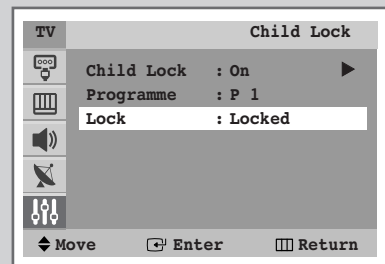
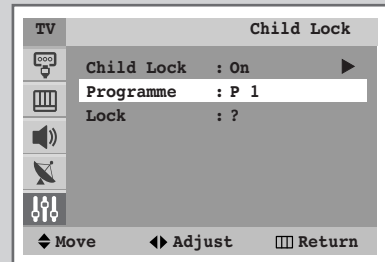
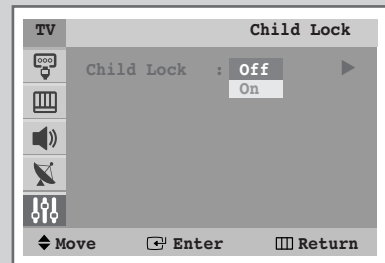
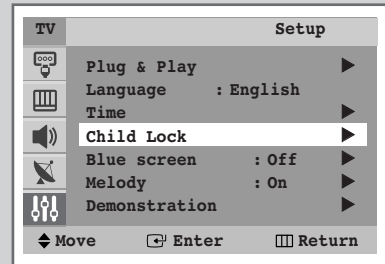

Viewing an External Signal Source (depending on the model)

ENG

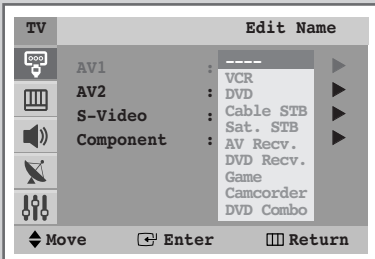
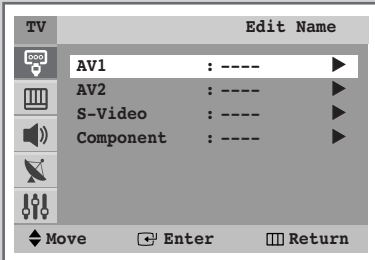
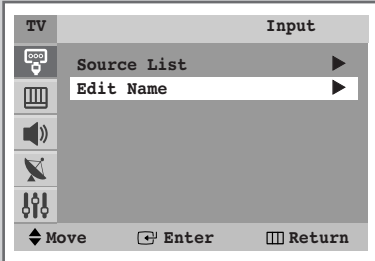
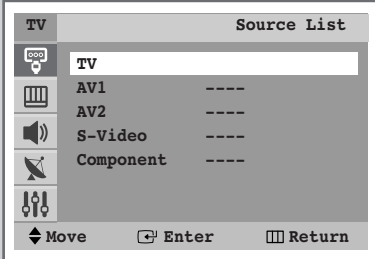
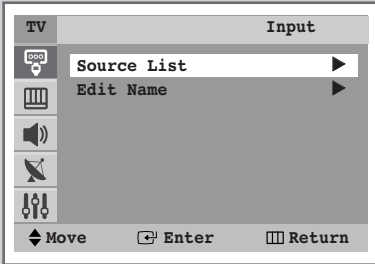

Use the remote control to switch between viewing signal from connected equipment, such as VCR, DVD, Set-Top-boxes and the TV source (broadcast or cable)

- 1 Press the **MENU** (□) button.
Result: The main menu is displayed.
- 2 Press the **ENTER** (↵) button to select **Input**.
Result: The options available in the **Input** group are displayed.
- 3 Press the **ENTER** (↵) button again to select **Source List**.
Result: The options available in the **Source List** group are displayed.
- 4 Press the **▼** or **▲** button to select signal source, then press the **ENTER** (↵) button.
 - When you connect equipment to the TV, you can choose between the following sets of jacks : **AV1**, **AV2**, **S-Video** or **Component** on the TV's rear panel, and **AV2** or **S-Video** on the TV's side (or front) panel.
 - **S-Video** and **Component** signal sources are depending on the model.
- 5 Press the **MENU** (□) button.
Result: The main menu is displayed.
- 6 Press the **ENTER** (↵) button to select **Input**.
Result: The options available in the **Input** group are displayed.
- 7 Press the **▼** or **▲** button to select **Edit Name**. Press the **ENTER** (↵) button.
Result: The options available in the **Edit Name** group are displayed.
- 8 Press the **▼** or **▲** button to select external device : **AV1 - AV2 - S-Video - Component**.
- 9 Press the **ENTER** (↵) button.
Result: The device names available are listed.
- 10 Select the name by pressing the **▼** or **▲** button. Press the **ENTER** (↵) button.
- 11 Set other signal sources (**AV1**, **AV2**, **S-Video**, **Component**) using the same method as listed above.

➤ You can also set these options simply by pressing the **VIDEO** (📺) button. If you change the external source while viewing, pictures might take a short period of time to be switched.

Viewing the Picture In Picture (PIP) (depending on the model)

ENG

You can display a sub picture within the main picture of TV program or external A/V devices such as VCR or DVD. In this way you can watch TV program or monitor the video input from any connected devices while watching TV or other video input.

- 1 Press the **MENU** () button.

Result: The main menu is displayed.

- 2 Press the ▼ or ▲ button to select **Picture**.

Result: The options available in the **Picture** group are displayed.

- 3 Press the **ENTER** () button.

- 4 Press the ▼ or ▲ button to select **PIP**. Press the **ENTER** () button.

- 5 Press the **ENTER** () button again.

- 6 Press the ▼ or ▲ button to **On**.

Result: The options available in the **PIP** group are displayed.

- 7 Press the **ENTER** () button.

➤ You can also activate the PIP simply by pressing the **PIP ON** button. To deactivate, press it again.

- 8 Press the ▼ or ▲ button to select **Source**.

- 9 Press the **ENTER** () button.

- 10 Press the ▼ or ▲ button to select a source of sub picture.

Result: The sources are displayed in the following order:
TV / AV1 / AV2 / S-Video

➤ In some PIP TV models, the PIP function will not operate if the same source to the main picture is selected for the sub-picture. When a TV channel is viewed on the main picture, PIP is not available for TV channels. If a TV source is selected, the message "Not available" will appear on the screen. The PIP picture can be viewed only when a source different from the main picture's is selected in the PIP window.

- 11 Press the **ENTER** () button.

- 12 Press the ▼ or ▲ button to select **Swap**.

- 13 Press the **ENTER** () button.

Result: The main picture and the sub picture are interchanged.

➤ You can also interchange the main picture and the sub picture simply by pressing the **SWAP** button.

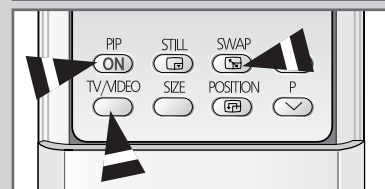
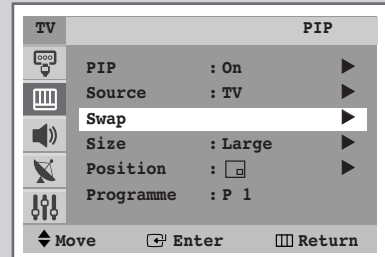
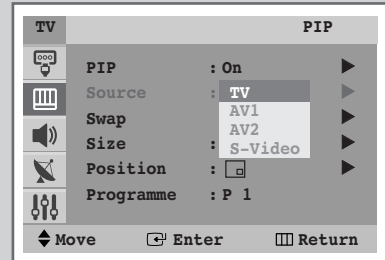
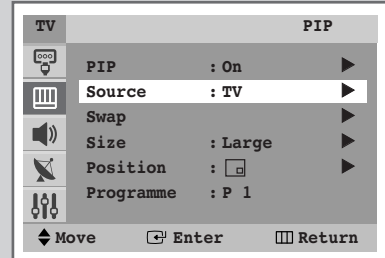
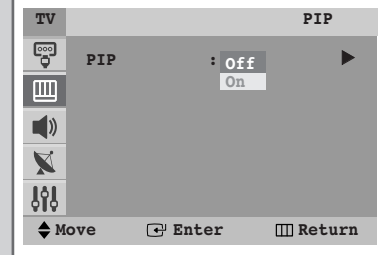
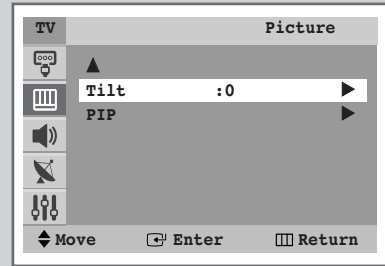

Viewing the Picture In Picture (PIP) (depending on the model) (continued)

ENG

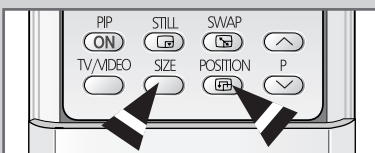
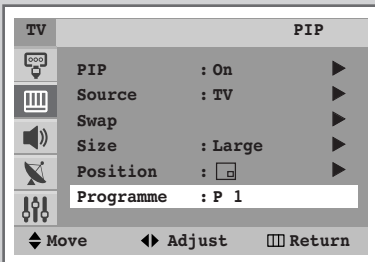
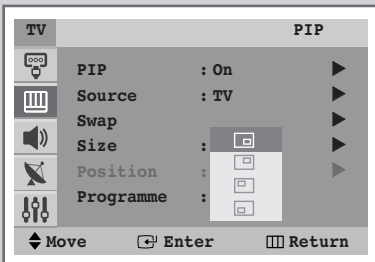
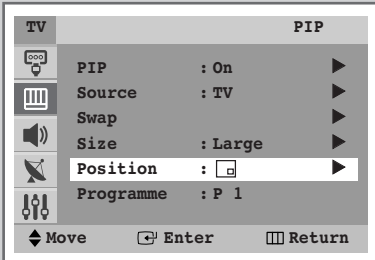
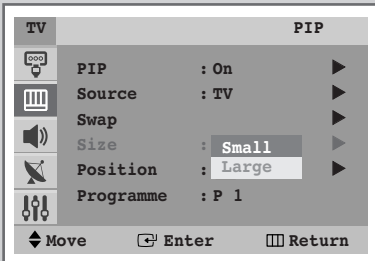
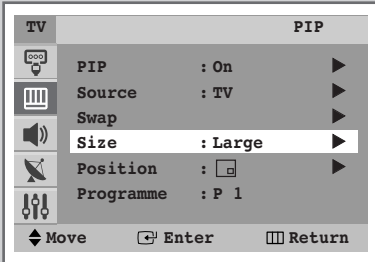

14 Press the ▼ or ▲ button to select **Size**.

15 Press the **ENTER** (⏎) button.

16 Select a size of sub picture by pressing the ▼ or ▲ button.

Result: The sizes are displayed in the following order:
Small – Large

17 Press the **ENTER** (⏎) button.

➤ You can select these options simply by pressing the **SIZE** button.

18 Press the ▼ or ▲ button to select **Position**.

19 Press the **ENTER** (⏎) button.

Result: The positions available are displayed.

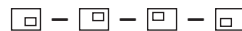

➤ You can select these options simply by pressing the **Position** (⏎) button.

20 Select a position of the sub picture by pressing the ▼ or ▲ button. Press the **ENTER** (⏎) button.

21 Press the ▼ or ▲ button to select **Programme**. You can select the channel that you want to view through sub picture by pressing the ◀ or ▶ button.

- ◆ When the **Source** is set to **TV**, you can select the channel of sub picture.
- ◆ You can select the channel of the sub picture simply by pressing the ▼ or ▲ button.

Viewing the Picture In Picture (PIP) (depending on the model) (continued)

ENG

Easy functions of remote control

Buttons	Feature
PIP ON	Used to activate or deactivate the PIP function directly.
STILL	Used to freeze the sub picture.
SWAP	Used to interchange the main picture and the sub picture. ➤ When the main picture is in the Video mode and the sub picture is in the TV mode, you might not hear the sound of main picture when pressing the SWAP (🔄) button after changing the sub picture channel. At this time, reselect the channel of main picture.
TV/VIDEO	Used to assign a source of sub picture (TV , AV1 , AV2 or S-VIDEO).
SIZE	Used to select a size of sub picture (Small or Large).
POSITION	Used to move the sub picture counterclockwise.
P ^/∨	Used to select the channel of sub picture.

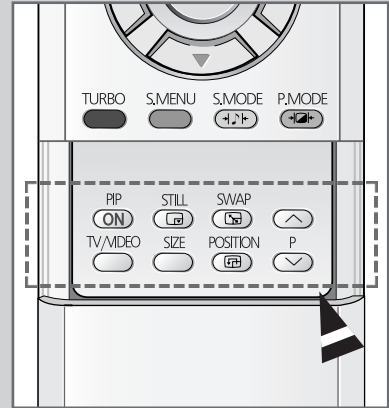

Teletext Feature (depending on the model)

ENG

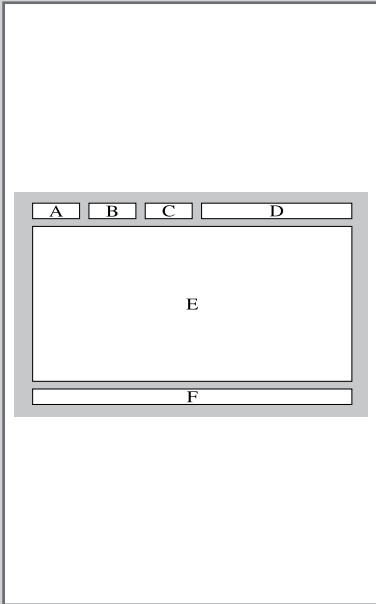

Most television channels provide written information services via teletext. Information provided includes:

- ◆ *Television programme times*
- ◆ *News bulletins and weather forecasts*
- ◆ *Sports results*
- ◆ *Travel information*

This information is divided into numbered pages (see diagram).

Part	Contents
A	Selected page number.
B	Broadcasting channel identity.
C	Current page number or search indications.
D	Date and time.
E	Text.
F	Status information. FASTEXT information.

- It can be different from depending on TTX source.
- Teletext information is often divided between several pages displayed in sequence, which can be accessed by:
 - ◆ Entering the page number
 - ◆ Selecting a title in a list
 - ◆ Selecting a colored heading (FASTEXT system)

Displaying the Teletext Information (depending on the model)



You can display Teletext information at any time on your television.

- ☞ For Teletext information to be displayed correctly, channel reception must be stable; otherwise:
 - ◆ Information may be missing
 - ◆ Some pages may not be displayed

- 1 Select the channel providing the Teletext service using the () or () button.
- 2 Press the **TTX/MIX** () button to activate the teletext mode.
Result: The contents page is displayed. It can be redisplayed at any time by pressing the (index) button.
- 3 If you wish to display the actual broadcast at the same time as the teletext page, press the **TTX/MIX** () button.
- 4 Press the **TV** () button to exit from the teletext display.



Selecting a Page by Number (depending on the model)

ENG







You can enter the page number directly by pressing the numeric buttons on the remote control.

- 1 Enter the three-digit page number given in the content by pressing the corresponding numeric buttons.

Result: The current page counter is incremented and the page is then displayed.

- 2 If the selected page is linked with several secondary pages, the secondary pages are displayed in sequence. To freeze the display on a given page, press the  (hold). Press the  (hold) again to resume.

Using the various display options:

To display...	Press the...
◆ Both teletext information and the normal broadcast	TTX/MIX  twice
◆ Hidden text (answers to quiz games, for example)	 (reveal)
◆ The normal screen	 (reveal) again
◆ A secondary page, by entering its 4-digit number	 (sub-page)
◆ The next page	 (page up)
◆ The previous page	 (page down)
◆ Double-size letters in the: <ul style="list-style-type: none"> • Upper half of the screen • Lower half of the screen 	 (size) <ul style="list-style-type: none"> • Once • Twice
◆ Normal screen	• Three times

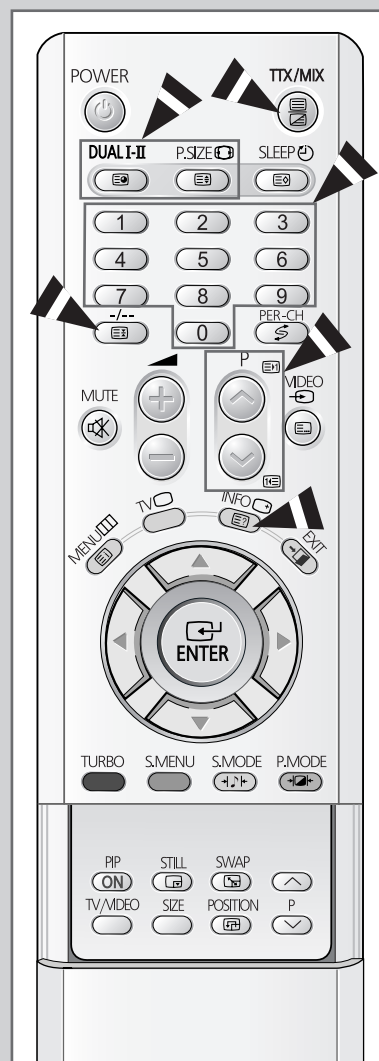

Using FLOF to Select a Page (depending on the model)

ENG

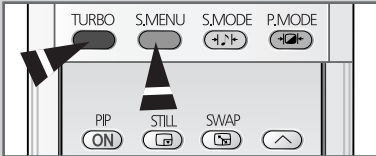
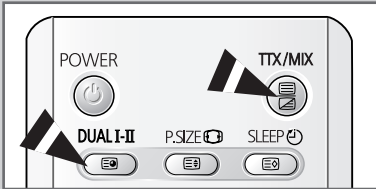

The various topics included in the teletext pages are color-coded, and can be selected by pressing the colored buttons on the remote control.

- 1 Display the teletext contents page by pressing the **TTX/MIX** (📄) button.
- 2 Press the colored button corresponding to the topic that you wish to select; the available topics are given on the status line.
Result: The page is displayed with other colored information that can be selected in the same way.
- 3 To display the previous or next page, press the corresponding colored button.
- 4 To display the subpage, see the following steps.
 - ◆ Press the (📄) (sub-page) button.
Result: The available subpages appear.
 - ◆ Select the required sub-page. Sub-pages can be scrolled by using the **TURBO** (Red) or **S.MENU** (Green) button.

Storing Teletext Pages (depending on the model)

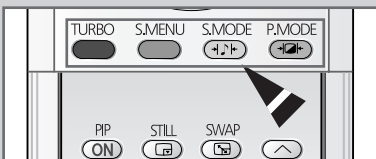
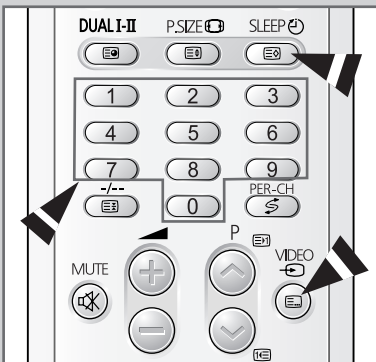

You can store up to four teletext pages to display them later at leisure.

- 1 Select the LIST mode using the (📄) button.
Result: Four 3-digit numbers are displayed in different colours.
➤ The (📄) button is used to switch between the LIST and FLOF modes.
- 2 Press the colored button corresponding to the page that will be replaced.
- 3 Enter the new page number using the numeric buttons.
- 4 Repeat steps 2 and 3 for each page to be stored, using a different colored button each time.
- 5 Press the (📄) (store) button until the corresponding blocks blink.

Connecting to the AV-1 or 2 Input/Outputs

➤ These figures show typical connector-jack panels. The actual configuration on your TV may be different, depending on your model.

➤ AV-1 is used for equipment with an RGB output, such as video game devices and video disc players or a VCR.

Rear of TV

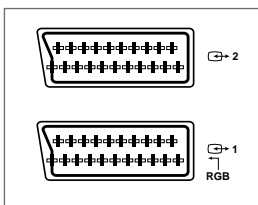
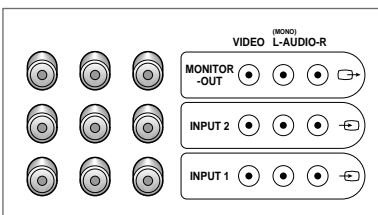

AV cable

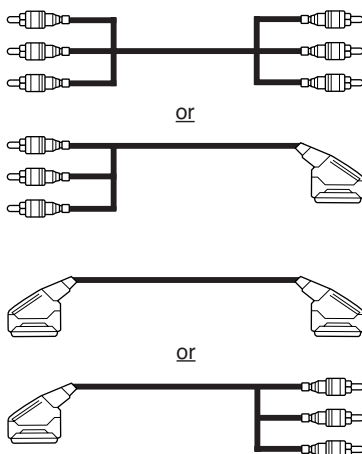

VCR

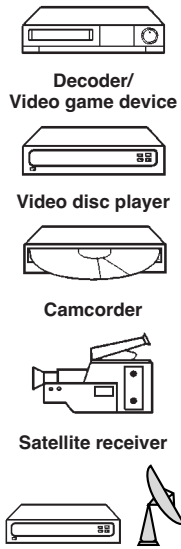

Connecting to the S-VIDEO Input (depending on the model)

➤ The S-VIDEO/RCA (AUDIO-L and R) connectors are used for equipment with an S-Video output, such as a camcorder or VCR.

Side of TV

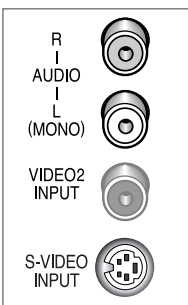

Front of TV

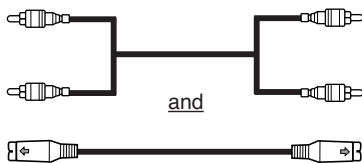
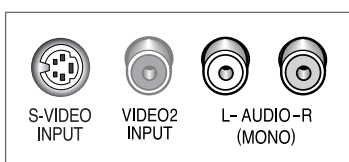

Camcorder

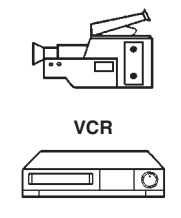

➤ When both the side AV and rear connectors are connected to external equipment, the side (or front) AV receives priority.

☞ Whenever you connect an audio or video system to your television, ensure that **all** elements are switched **off**. Refer to the documentation supplied with your equipment for detailed connection instructions and associated safety precautions.

Connecting to the DVD Input (depending on the model)

- The Component/RCA (AUDIO-L and R) connectors are used for equipment with a DVD output.

Rear of TV

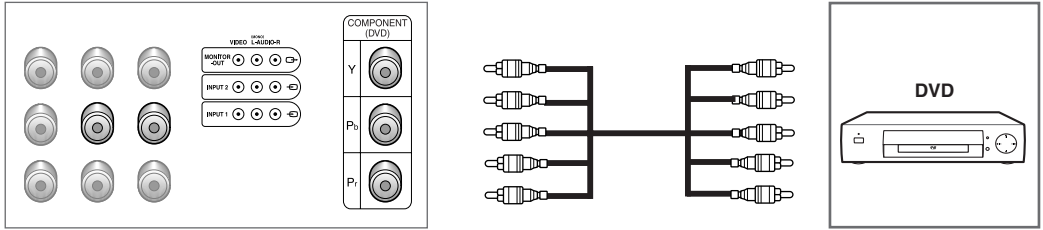

Connecting to the RCA Input (depending on the model)

- The RCA (VIDEO and AUDIO-L+R) connectors are used for equipment, such as camcorders, video disc players, and some video game devices.

Side of the TV

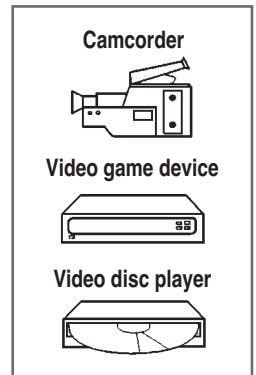
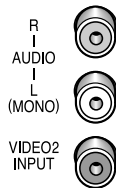

Connecting to the Audio Output (depending on the model)

- The "MONITOR OUT" (L-AUDIO-R) connectors are used for equipment, such as an audio system (to take full advantage of the Surround sound effect).

Rear of the TV

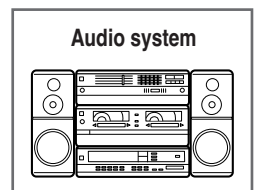
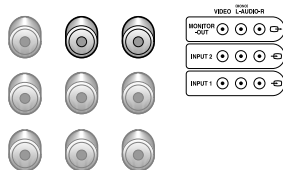

Connecting Headphones (depending on the model)

ENG

You can connect a set of headphones to your television if you wish to watch a television programme without disturbing the other people in the room.

- 1 Plug a set of headphones into the 3.5 mm mini-jack socket of the television.

Result: The sound is heard through the headphones.

- 2 When you wish to hear the sound through the speakers again, simply disconnect the headphones.

- Prolonged use of headphones at a high volume may damage your hearing.

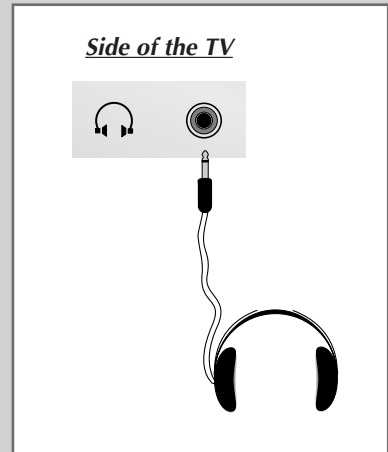

Viewing Pictures From External Sources (depending on the model)

Once you have connected up your various audio and video systems, you can view different sources by selecting the appropriate input.

- 1 Check that all the necessary connections have been made.
- 2 Switch your television on, then press the **VIDEO**() button repeatedly.

Result: The input sources are displayed in the following order:

- ◆ AV1 → AV2 → S-VIDEO (option) → Component (option) - (RCA model)
- ◆ AV1 → AV2 → S-VIDEO (option) - (SCART model)

- Depending on the source selected, the pictures may appear automatically.

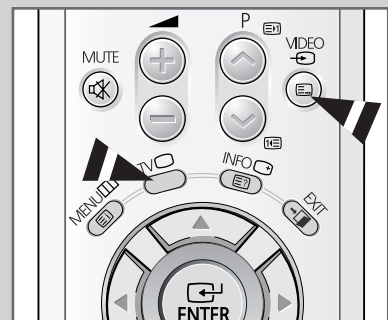

- To watch television programmes again, press the **TV**() button and select the number of the channel required.

Automatic Degaussing to Remove Colour Patches

ENG

A degaussing coil is mounted around the picture tube, so you do not normally need to degauss the television manually.

If you move the television to a different position and color patches appear on the screen, you must:

- ◆ Switch the television off by pressing the “⏻” (On/Off) button on the front panel
- ◆ Unplug the television from the wall socket
- ◆ Leave the television power-off for about 30 minutes so that the automatic degauss function can be activated, and then press the “POWER ⏻” button on the remote control.



If your television will be left unattended, press the “⏻” (On/Off) button to turn your television off.

Troubleshooting: Before Contacting Service Personnel

Before contacting Samsung after-sales service, perform the following simple checks.

If you cannot solve the problem using the instructions below, note the model and serial number of the television and contact your local dealer.

No sound or picture	<ul style="list-style-type: none">◆ Check that the mains lead has been connected to a wall socket.◆ Check that you have pressed the “⏻” button (On/Off) and the POWER (⏻) button.◆ Check the picture contrast and brightness settings.◆ Check the volume.
Normal picture but no sound	<ul style="list-style-type: none">◆ Check the volume.◆ Check whether the volume MUTE (🔇) button on the remote control has been pressed.
No picture or black and white picture	<ul style="list-style-type: none">◆ Adjust the colour settings.◆ Check that the broadcast system selected is correct.
Sound and picture interference	<ul style="list-style-type: none">◆ Try to identify the electrical appliance that is affecting the television, then move it further away.◆ Plug your television into a different mains socket.
Blurred or snowy picture, distorted sound	<ul style="list-style-type: none">◆ Check the direction, location and connections of your aerial. This interference often occurs due to the use of an indoor aerial.
Remote control malfunctions	<ul style="list-style-type: none">◆ Replace the remote control batteries.◆ Clean the upper edge of the remote control (transmission window).◆ Check the battery terminals.

Large empty rectangular box for writing the memo content.

– AFTER SALES SERVICE

- Do not hesitate to contact your retailer or service agent if a change in the performance of your product indicates that a faulty condition may be present.

