

SAMSUNG

USER'S MANUAL

AW08PH Series
AW08PK Series
AW12PH Series
AW12PK Series
AW18PH Series
AW18PK Series
AW24PH Series
AW24PK Series
AW122PB

Window-type Room Air Conditioner (Cooling)

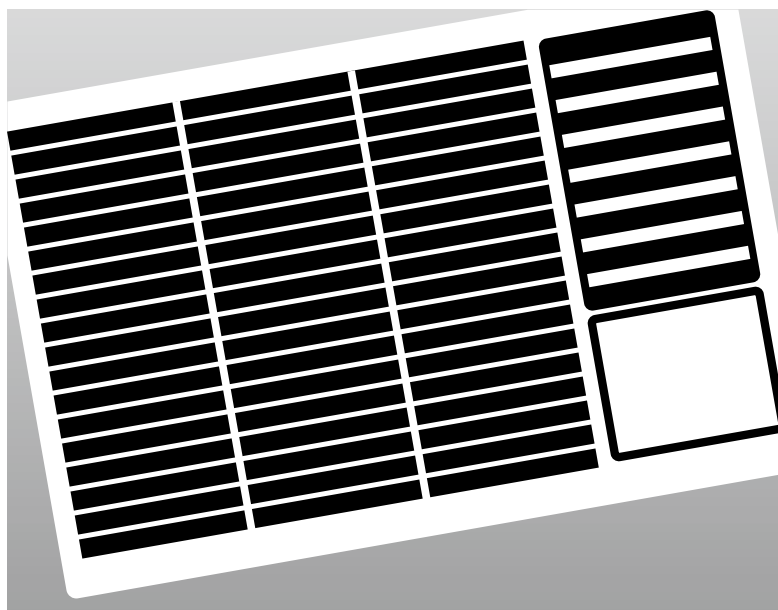

Safety Precautions

The following safety precautions must be taken when using your air conditioner.



WARNING

Risk of electric shock. • Can cause injury or death. • Disconnect all remote electric power supplies before servicing, installing or cleaning.
• This must be done by the manufacturer or its service agent or a similar qualified person in order to avoid a hazard.

DURING OPERATION

- ◆ Users of this product are cautioned not to attempt repair of this product at their own discretion. Instead, they are requested to directly contact a designated service center or the outlet at which the product was purchased.
- ◆ Never spill any kind of liquid into the unit. Should this happen, unplug or main switch off the unit and contact an authorized service center.
- ◆ Do not insert anything between the air outlet blades because the inner fan may be damaged and could cause injury. Keep children away from the unit.
- ◆ Do not place any obstacles in front of the unit.
- ◆ Do not spray liquid of any kind into the indoor unit. Should this happen, switch off the breaker used for your air conditioner and contact your installation specialist.
- ◆ Make sure that the unit is correctly ventilated at all times:
Do not place clothing or other materials over it.
- ◆ If the wireless remote control will not be used for a long time, remove the batteries. (If applicable)
- ◆ When using a wireless remote control, the distance should not be more than 7 meters from the air conditioner. (If applicable)
- ◆ The air conditioner must be plugged into its own specific power source, which must be installed in compliance with national wiring, earthing and safety regulations.
- ◆ If the power cord is damaged in any way, it must be replaced by the manufacturer or its service agent or a similarly qualified person in order to avoid a hazard.
- ◆ This device must be installed according to the national electrical rules.
- ◆ The appliance must be installed so that the plug should be easily accessible after installation.
- ◆ If the fuse on PC board is broken please change it with the type of T 3.15A 250V.
- ◆ The breaker of the air conditioner should be all-pole switch; and the distance between its two contacts should be no less than 3.5mm. Such means for disconnection must be incorporated in the fixed wiring.

DISPOSING OF THE UNIT

- ◆ Before throwing out the device, it is necessary to pull back the battery cells and get rid of them safely for recycling reasons.
- ◆ When you need to dispose of the unit, consult your dealer. If pipes are removed incorrectly, refrigerant may blow out and come into contact with your skin, causing injury. Releasing refrigerant into the atmosphere also damages the environment.
- ◆ Please recycle or dispose of the packaging material for this product in an environmentally responsible manner.

OTHERS

- ◆ Never store or ship the air conditioner upside down or sideways to avoid damage to the compressor.
- ◆ The appliance is not intended for use by young children or infirm persons without supervision: Young children should be supervised to ensure that they do not play with the appliance.
- ◆ Max current is measured according to IEC standard for safety and current is measured according to ISO standard for energy efficiency.

Contents

◆ PREPARING YOUR AIR CONDITIONER	
■ Safety Precautions	2
■ Air Conditioning Unit-Main Parts, Buttons and Display.....	4
■ Remote Control-Buttons.....	5
■ Getting Started	6
■ Inserting the Remote Control Batteries	7
◆ OPERATING YOUR AIR CONDITIONER	
■ Cooling Your Room.....	8
■ Airing Your Room.....	9
■ Removing Excess Humidity.....	10
■ Adjusting the Air Flow Direction Horizontally	11
■ Adjusting the Air Flow Direction Vertically	11
◆ PROGRAMMING YOUR AIR CONDITIONER	
■ Setting the On Timer	12
■ Setting the Off Timer	13
■ Selecting Good Morning mode	14
■ Selecting Energy saving mode.....	15
◆ RECOMMENDATIONS FOR USE	
■ Temperature and Humidity Ranges	15
■ Cleaning Your Air Conditioner.....	16
■ Solving Common Problems.....	17
■ Technical Specifications	18
◆ INSTALLATION.....	19

CAUTION

“The high inrush current of the starting compressor motor can have adverse effects to the operation of other equipment under unfavorable mains conditions. This equipment does not comply with the relevant technical standards for the limitation of voltage fluctuations and flicker.”

Before connection this equipment to the power supply system, please report to your supply authority and obtain the consent.

Do not connect other electric appliances to the same supply lines.

AW18**

The maximum permissible system impedance at the power junction box is 0.24 ohms. Usually, the maximum permissible mains impedance will not be exceeded when the branch to the power outlet is fed from a junction box with a rated current of 32A.

Air Conditioning Unit - Main Parts, Buttons and Display

The design and shape are subject to change according to the model.

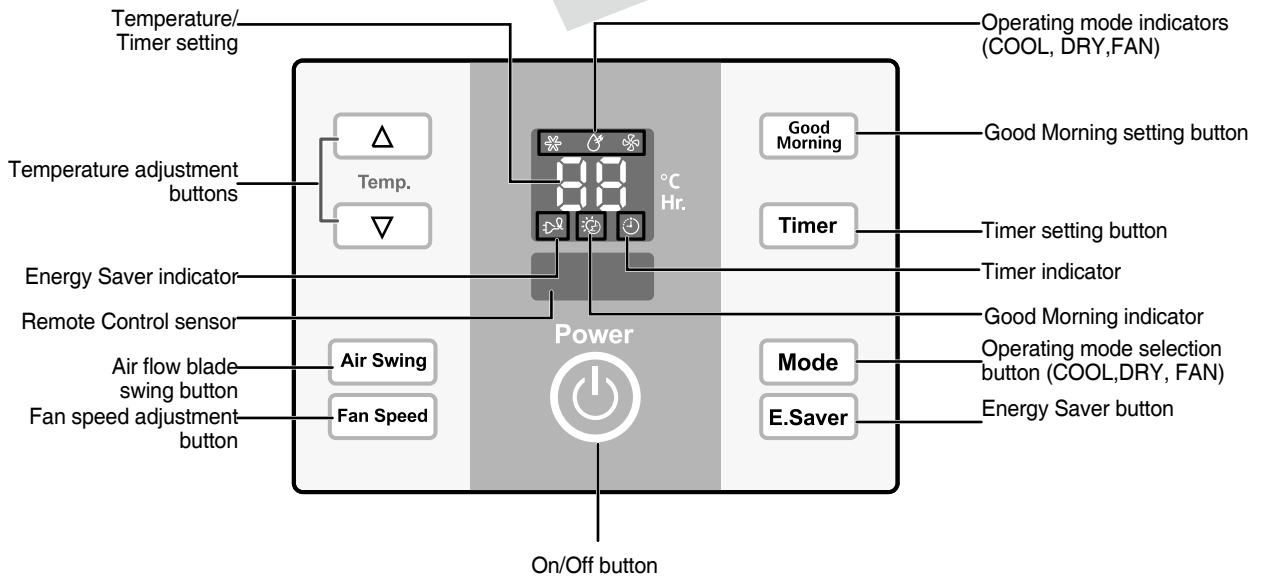
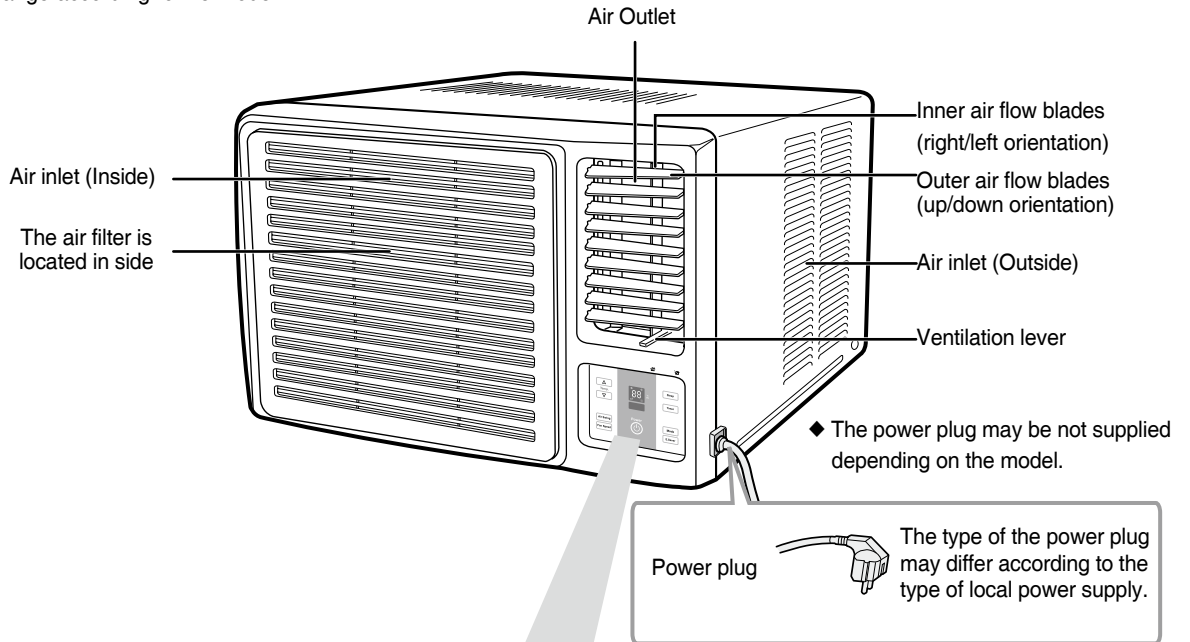

Remote Control - Buttons

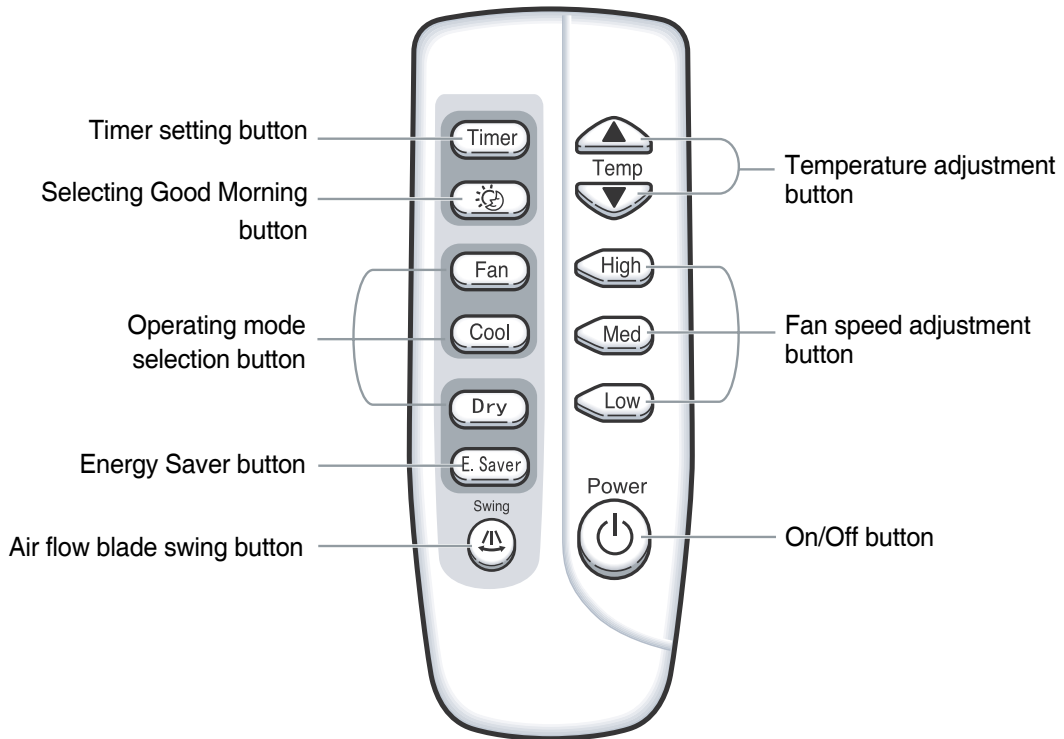

Getting Started

You have just purchased a window-type room air conditioner and it has been installed by your installation specialist.

Your Owen's Instructions contain valuable information on using your air conditioner.

Please take the time to read them as they will help you take full advantage of the unit's functions.

This Owner's Instructions is just for using your air conditioner correctly.

Thus, the illustrations shown in this manual may not exactly match your air conditioners.

The booklet is organized as follows.

◆ *The following figures are shown on pages 4 and 5:*

- *Air conditioning unit (main parts, buttons and display)*
- *Remote control (buttons)*



They will help you find the buttons and understand the symbols displayed.

◆ *In the manual, you will find a series of step-by-step procedures for each function available.*

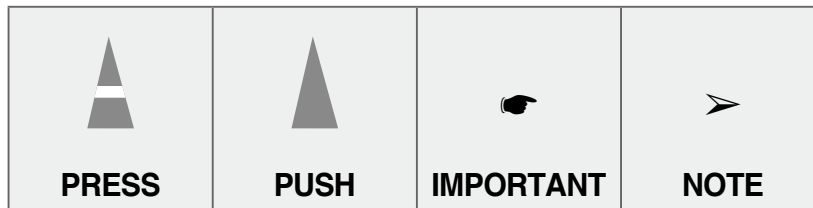
The illustrations in the step-by-step procedures use four different symbols:



Moreover, applicable, wherever the illustrations show the positions of the buttons on both the remote control and the unit itself.

For the...	The illustrations have a...
Remote control	Gray background. <u>Example:</u> 
Unit itself	White background. <u>Example:</u> 

Inserting the Remote Control Batteries

You must insert or replace the remote control batteries when:

- ◆ **You purchase the air conditioner**
- ◆ **The remote control does not work correctly**



Use two AAA, LR03 1.5V batteries. Do not use old batteries or different kinds of batteries together.

Batteries may be completely discharged after 12 months, even if they have not actually been used.

- 1 Push the battery cover on the rear of the remote control with your thumb in the direction of the arrow and remove it.
- 2 Insert the two batteries, taking care to respect the polarities:
 - ◆ + on the battery with + on the remote control
 - ◆ - on the battery with - on the remote control
- 3 Close the cover by sliding it back until it clicks into place.

Result: You can control all the functions your air conditioning unit directly from your seat, using the remote control.

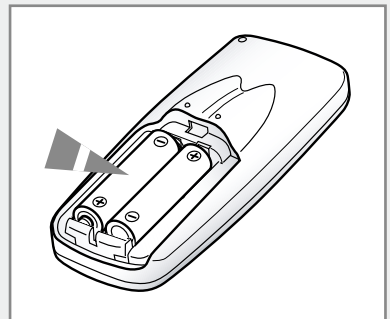
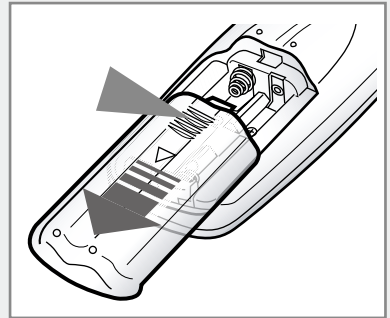

Cooling Your Room

Remote Control

Control Panel

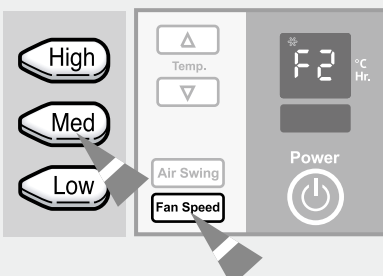
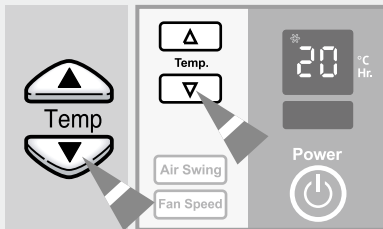
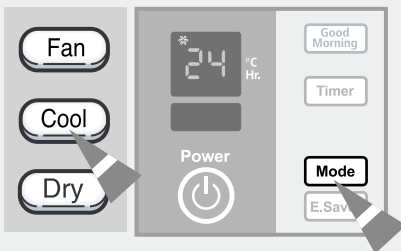

You must select the Cool mode if you wish to lower the temperature in your room. You can also set the fan speed.

- 1 If necessary, press the (On/Off) button.

Result:

- ◆ The air conditioner starts up in the Cool mode.
- ◆ The unit beeps twice.

The air conditioner is fitted with a protection mechanism to prevent the unit from being damaged when it is started immediately after being:

- ◆ Plugged in
- ◆ Stopped

It will start up to cool automatically after about three minutes.

- 2 If the COOL indicator is not lit up on the unit:

- ◆ Press the button on the remote control

or

- ◆ Press the button on the unit one or more times until the COOL indicator lights up

Result:

- ◆ The unit beeps each time you press the / button.
- ◆ The air conditioner starts up in Cool mode.

> You can change modes at any time.

- 3 To adjust the temperature, press the or button on the remote control one or more times until the required temperature is displayed.

To adjust the temperature, press the or button on the unit one or more times until the required temperature is displayed.

Possible temperatures are between 18°C and 30°C inclusive.

Result:

- ◆ Each time you press the temperature buttons.

- The temperature is adjusted by 1°C and displayed on the control panel

- The unit beeps

- ◆ The air conditioner starts cooling if the room temperature is higher than the selected temperature.

- 4 **To set the fan speed to... Then...**

- ◆ Press the , or button on the remote control as desired.

or

- ◆ Press the button on the unit one or more times until the desired fan speed (F1, F2, or F3) is displayed.

F 1: Low Speed

F 2: Med Speed

F 3: High speed

- 5 To control the direction of the air flow, refer to page 11.

Airing Your Room

If the atmosphere in your room is stale, you can air it using the Fan feature and if necessary, evacuate the stale air outside.

- 1 If you wish to evacuate stale air outside, push the ventilation lever on the front of the unit to the right and the open position ().

Result: The air inside the room circulates and stale air is evacuated outside.

Otherwise, push the ventilation lever to the left and the closed position ().



Result: The air simply circulates inside the room.

- 2 If necessary, press the  (On/Off) button.



Result:

- ◆ The air conditioner starts up in the Cool mode.
- ◆ The unit beeps twice.

- 3 If the FAN indicator is not lit up on the unit:

- ◆ Press the  button on the remote control
or
- ◆ Press the  button on the unit one or more times until the FAN indicator lights up



Result:

- ◆ The unit beeps each time you press the  /  button.
- ◆ The air conditioner starts up in Fan mode.

- You can change modes at any time.

When the air conditioner is in the Fan mode, the temperature is not displayed; in this case, you do not need to set the temperature.

- 4 **To set the fan speed to... Then...**

- ◆ Press the ,  or  button on the remote control as desired.
or

- ◆ Press the  button on the unit one or more times until the desired fan speed (F1, F2, or F3) is displayed.

F 1 : Low Speed

F 2 : Med Speed

F 3 : High speed

- 5 To control the direction of the air flow, refer to page 11.

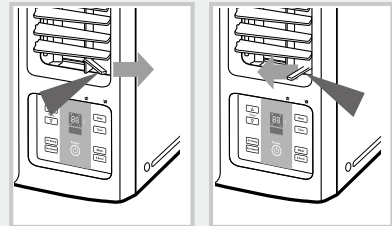

Remote Control

Control Panel

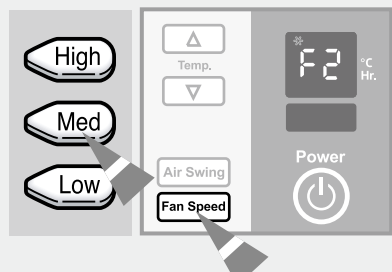
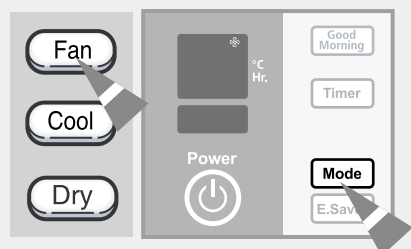

Removing Excess Humidity

If the atmosphere in your room is very humid or damp, you can remove excess humidity without lowering the room temperature too much.

Remote Control Control Panel

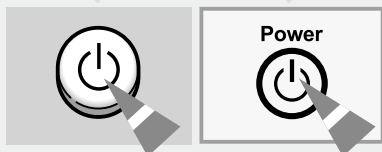

- 1 If necessary, press the  (On/Off) button.

Result:



- ◆ The air conditioner starts up in the Cool mode.
- ◆ The unit beeps.

 The air conditioner is fitted with a protection mechanism to prevent the unit from being damaged when it is started immediately after being:

- ◆ Plugged in
- ◆ Stopped

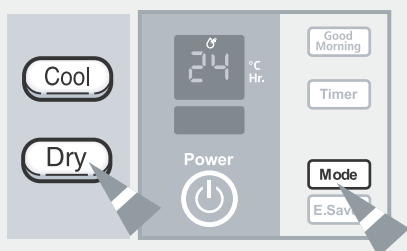
It will start up to cool normally after three minutes .





- 2 If the  is not displayed at the top of the control panel, press the  button on the control panel or press  button on the remote control one or more times until it appears.

Result:

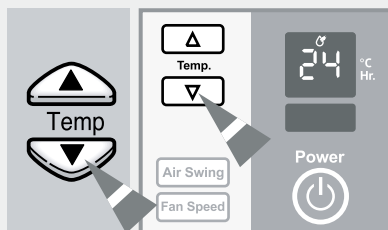

- ◆ The unit beeps each time you press the  button.
- ◆ The air conditioner runs in Dry mode.

> You can change modes at any time.



- 3 To adjust the temperature, press the  or  buttons one or more times until the required temperature is displayed. Possible temperatures are between 18°C and 30°C inclusive.

Result:



- ◆ Each time you press the  or  buttons.
 - The temperature is adjusted by 1°C
 - The unit beeps
- ◆ The air conditioner starts removing the excess humidity; the quality of air is adjusted automatically.

- 4 To control the direction of the air flow, refer to page 11.

Adjusting the Air Flow Direction Horizontally

Depending on the position of the unit in your room, you can adjust the orientation of the inner air flow blades on the right-hand side of the unit, thus increasing the efficiency of the air conditioner.

- 1 Press the  (or **Air Swing** on the unit) button on the remote control.
Result: The inner blades swing automatically left and right.

- 2 To stop the blades moving left and right, press the  (or **Air Swing** on the unit) button in the remote control.
 - To stop the blades in a specific position and orient the air flow in the corresponding direction, simply press the  (or **Air Swing** on the unit) button on the remote control when the blades are in the desired position.

Remote Control Control Panel

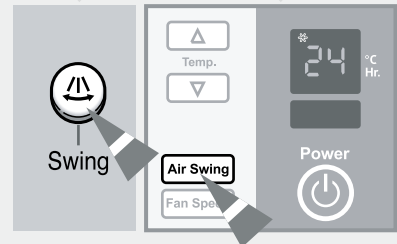

Adjusting the Air Flow Direction Vertically

Again depending on the position of the unit in your room, you can adjust the orientation of the outer air flow blades on the right-hand side of the unit.

RECOMMENDATION

When...	Adjust the blades to face...
Cooling	Upwards.

Adjust the air flow blades to the desired position, by pushing them upwards or downwards.

- If you orient the air flow blades downwards and the unit operates in Cool mode for a long period of time, dew may:
 - ◆ Form on the surface of the blades
 - ◆ Drip from the blades

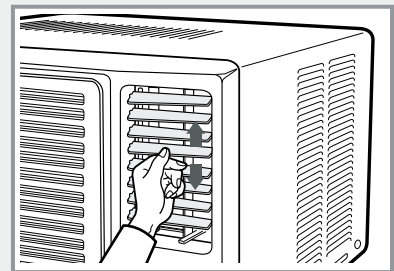

Setting the On Timer

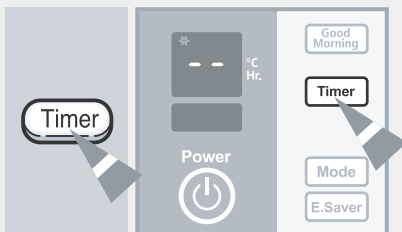
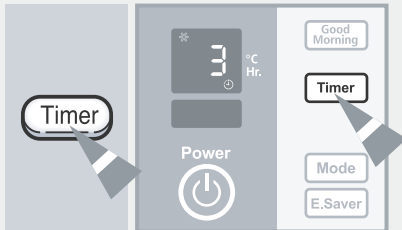
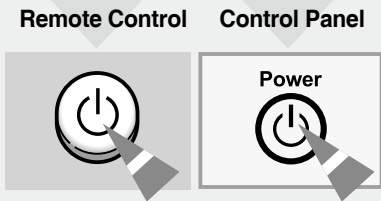

The On Timer enables you to switch on the air conditioner automatically after a given period time. You can set the period of time from 1 hour to 24 hours. You can select the On Timer only when the air conditioner is off.

- 1 Check that the air conditioner has been switched off; if necessary, press the  (On/Off) button.

- 2 Set the operating time by pressing:

- ◆  on the remote control.

OR

- ◆  on the unit one or more times.

Possible time is between 1 hour and 24 hours inclusive.



Result:

- ◆ The remaining time is displayed and decreased by 1 hour automatically to indicate the remaining time.
- ◆ The air conditioner switches on automatically when the operating time reaches zero.

> You can change the fan speed and others after setting the On Timer.

To Cancel the On Timer

To cancel the On Timer, press:

- ◆  on the remote control or  on the unit one or more times until "  " is displayed.

or

- ◆  (On/Off) button on the remote control or unit.

Setting the Off Timer

The Off Timer enables you to switch off the air conditioner automatically after a given period of time. You can set the period of time from 1 hour to 24 hours. You can select the Off Timer only when the air conditioner is on.

- 1 Check that the air conditioner has been switched on; if necessary, press the  (On/Off) button.

- 2 Set the operating time by pressing:

- ◆  on the remote control.

or

- ◆  on the unit one or more times.

Possible time is between 1 hour and 24 hours inclusive.

Result:

- ◆ The remaining time is displayed and decreased by 1 hour automatically to indicate the remaining time.
- ◆ The air conditioner switches off automatically when the operating time reaches zero.

➤ You can change the fan speed and air flow direction and others after setting the Off Timer.

Remote Control





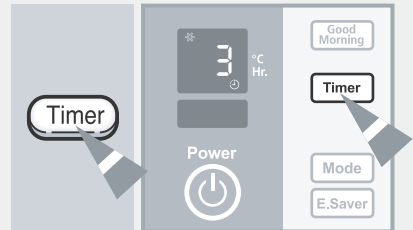
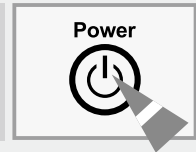

Control Panel



To Cancel the Off Timer

To cancel the Off Timer, press:

- ◆  on the remote control or  on the unit one or more times until "  " is displayed.
- or
- ◆  (On/Off) button on the remote control or unit.

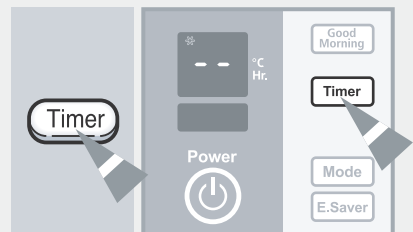

Selecting Good Morning Mode

Remote Control Control Panel

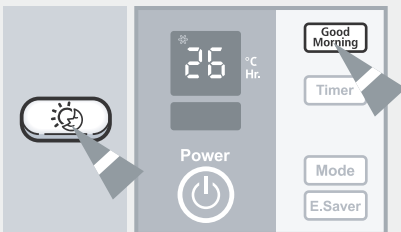
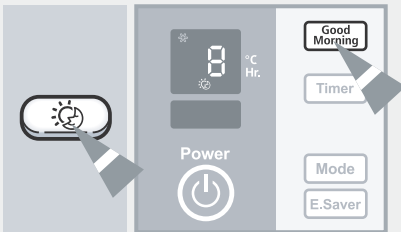

The Good Morning mode can be used when you are cooling your room to switch the air conditioner off automatically after 8 hours.

➤ **The Good Morning function can be set whether the air conditioner is switched on or off, and this function can be selected for any mode.**

Press the  button on the remote control

or

Press the  button on the unit .

Result:

- ◆ Each time you press a button, the unit beeps.
- ◆ The  indicator and " 8 " will be displayed.
- ◆ The remaining time is displayed and decreased by 1 hour automatically to indicate the remaining time.
- ◆ If Good Morning is selected after switching on the unit ,the air conditioner will run in Cool mode. During this period, the temperature displayed is one you set for the Cool mode. If the Good Morning is selected before switch on the unit, the air conditioner starts running in Cool mode and the temperature is set to 26 °C.
- ◆ The fan is running in low mode, and you can adjust the speed.

To Cancel the Good Morning Timer

If you no longer wish to use the Good Morning mode that you have set, you can cancel it at any time.

1 Press the  button on the remote control.

or

press the  button on the unit to switch off the air conditioner.

2 To cancel a selected Good Morning mode, you can also press the , ,  or  button on the remote control

or

press the , ,  or  button on the unit.

Result:

- ◆ The unit beeps.
- ◆ The  indicator is no longer displayed.
- ◆ The air conditioner operates in the mode selected last.

➤ If you select the Energy Saving mode in the Good Morning mode, the Good Morning mode will be canceled and the air conditioner will start up in the Energy Saving mode.

Selecting Energy Saving Mode

If you wish to save Energy when using your air conditioner, select the Energy Saving mode with the Energy Saver button.

- 1 To select the Energy Saving mode, press the Energy Saver button on the remote control or unit one or more times until the Energy Saver indicator lights up.

Result:

- ◆ The fan and compressor cycle on and off together.
- ◆ The fan will continue to run for a short time after the compressor cycles off.

- 2 To stop the Energy Saving mode, press the Energy Saver button on the remote control or unit again.

Result: The fan runs at all times, while the compressor cycles on and off.

- If you select the Good Morning mode in the Energy Saving mode, the Energy Saving will be cancelled and the air conditioner will start up in the Good Morning mode.

Remote Control Control Panel

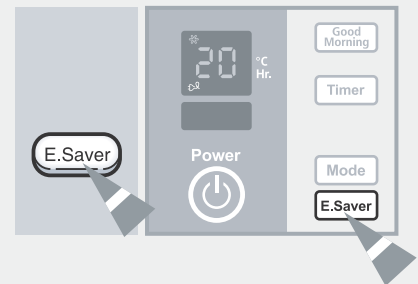

Temperature and Humidity Ranges

The following table indicates the temperature and humidity ranges within which the air conditioner can be used in the best condition .

Mode	IndoorTemperature	OutdoorTemperature	Indoor Humidity
Cooling	21°C to 32°C approx.	21°C to 43°C approx.	80% or less

If the air conditioner is used at...	Then...
Higher temperatures	The automatic protection feature may be triggered and the air conditioner stopped.
Lower temperatures	A water leakage or some other malfunction may happen if the heat exchanger freezes.
Higher humidity levels	Water may condense on and drip from the surface of the unit if it is used for long periods.

Cleaning Your Air Conditioner

Be sure to clean the air filter periodically to maintain the air conditioner in the best condition for a long period of time.

IMPORTANT When cleaning the air conditioner, turn it off and pull out the power plug.

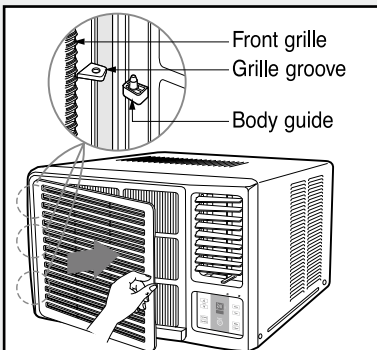
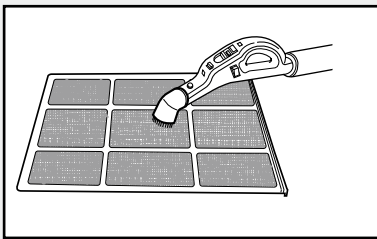
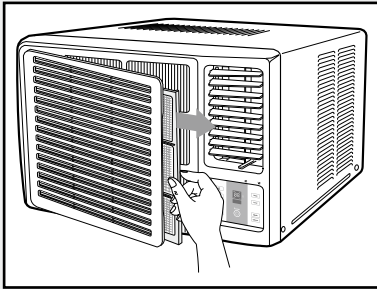

The air conditioner has two or three grille grooves depending on the model.

- 1 Hold the front grille handle, slightly pull it to the left side and open the front grille.

➤ The removal of the front grille makes it easier to clean the air conditioner. Open the grille as much as possible.

CAUTION

Removal and Reassembly of the Front Grille

For user's safety, a safety clip has been installed in the front grille.

- 1 Grasp the lower part of the front grille and the front grille handle, then open the grille. (The open angle of front grille has not to be exceeded 25 degree)
- 2 Lift the front grille slightly and remove it from the front panel.
- 3 Reassembling of front grille should be done in reverse order of disassembly.

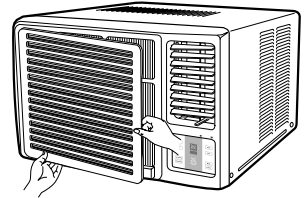

- 2 Pull the air filter to the right side.

- 3 Remove all dust on the air filter with a vacuum cleaner or brush.





- 4 When you have finished, insert the air filter back into its original position.

- 5 Wipe the surface of the unit with a neutral detergent and then wipe it again with dry cloth.
(Be sure not to use benzene, solvent or other chemical products.)

If you...	Then...
Will not be using the air conditioner for a long period of time	<ul style="list-style-type: none"> ◆ Set the fan going for a few hours to dry the inside of the air conditioner thoroughly. ◆ Switch the air conditioner off and unplug it from the wall socket. ◆ Clean the filter and outer surfaces.
Have not used the air conditioner for a long period of time	Set the fan going for a few hours to dry the inside of the air conditioner thoroughly.

Solving Common Problems

Before contacting the after-sales service, perform the following simple checks. They may save you the time and expense of an unnecessary service call.

Problem	Explanation/Solution
The air conditioner does not operate at all	<ul style="list-style-type: none">◆ Check that the circuit breaker used for the air conditioner has not been triggered.◆ Check that the power cable is plugged into a wall socket and the socket is switched on, if necessary.◆ Check that the operating mode indicator (COOL or FAN) on the unit is lit up; if necessary press (On/Off) button on the remote control or unit.
The air conditioner does not operate with the remote control	<ul style="list-style-type: none">◆ Check that there are no obstacles between you and the unit.◆ Replace the remote control batteries if necessary.◆ Check that you are close enough to the unit (seven metres/yards or less).
No beep is heard when you press  (On/Off) on the remote control	<ul style="list-style-type: none">◆ Check that you are pointing the remote control at the remote control sensor on the unit.◆ Replace the remote control batteries if necessary.
The air conditioner does not cool	<ul style="list-style-type: none">◆ Check that the correct operating mode has been selected COOL..◆ The room temperature may be too low.◆ Dust may be blocking the air filter; refer to page 16 for cleaning instructions.◆ Check that there is no obstacle blocking the air flow into or out of the unit.
The air flow direction does not change when you press the  or  on the unit button	<ul style="list-style-type: none">◆ Check that the air conditioner has been switched on; if necessary, press  (On/Off) button on the remote control or unit.
The timer is not correctly triggered	<ul style="list-style-type: none">◆ Check that the timer has been programmed correctly; see page 12~13.
Odour is permeated in the room during air conditioning	<ul style="list-style-type: none">◆ Air the room.

Technical Specifications

Design and specifications are to change without notice





Model	Voltage & Frequency	Capacity	Power Consumption	Operating Current
AW12PKAA	115V~, 60Hz	12000BTU/h	1230W	11,2A
AW12PKBA	220V~, 60Hz	12000BTU/h	1230W	5,5A
AW18PKBA	220V~, 60Hz	18000BTU/h	1850W	8,3A
AW24PKBA	220V~, 60Hz	24000BTU/h	2820W	12,5A
AW12PKAB	115V~, 60Hz	12000BTU/h	1110W	10,0A
AW12PKBB	220V~, 60Hz	12000BTU/h	1110W	5,2A

Installation (for 60Hz)

1 Electrical Requirements

For personal safety:

- ◆ This appliance must be properly grounded.
- ◆ Do not, under any circumstances, cut or remove the third grounding prong from the power cord.
- ◆ We recommend that you do not use an extension cord or an adapter plug with this appliance.
- ◆ Do not change the plug on the power cord of this appliance.
- ◆ Follow national electrical codes or local codes and ordinances.

115V 15 AMP Circuit "parallel" type	230V/208V 20 AMP circuit "perpendicular" type	230V/208V 15AMP circuit "tandem" type	230V/208V 30 AMP circuit "tandem" type
			

- ◆ If the electric supply provided does not meet the above specifications, call a licensed electrician.
- ◆ Aluminum house wiring may pose special problemsconsult a qualified electrician.
- ◆ This unit requires a separate circuit, serving only this appliance.

Installation (cont.)

Before installation, be sure to check the installation area or the air conditioner, and drain hose.

Checkpoints prior to installation

- 1 Check the cabinet and front grille of the unit for any harmful defects such as scratches.
- 2 Be sure to check the power supply.
- Refer to the specifications on the label attached to the unit.

Installation Conditions

- 1 As the unit is heavy, the wall or window of the installation area should have sufficient strength and durability for operation of the air conditioner, and for prevention of any vibration or noise.
If it is weak, reinforcement work should be performed separately.
- 2 It is advisable to install the air conditioner in the north or west side to prevent the effect of direct sunlight.
When installing it in the south or east side due to unavoidable circumstances, it is advisable to install the sunshade to prevent the direct sunlight.
In this case, take care not to cause any hindrance to the flow of outside air.
- 3 When installing the air conditioner, be sure to obtain sufficient space on the rear side of the unit for smooth flow of air.
When operating the air conditioner in closed areas such as inner building with cooling operation, and result in trouble with the unit.
See the illustration below.

- ◆ The appliance must be fixed well by screw or similar method.

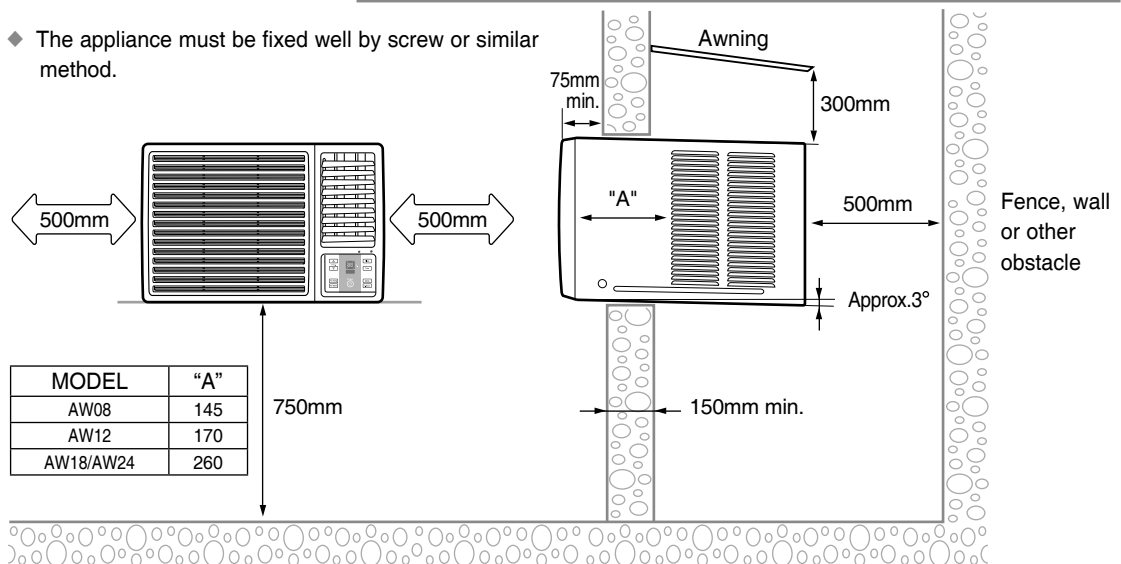

- ◆ If the wall is greater than 150mm thick, cut the wall back on a 45 degree angle if possible.

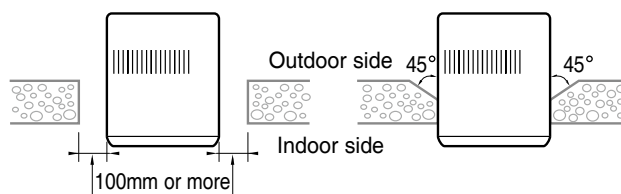

Installation (cont.)

*In some region, drain tube and drain pan may not be supplied.
Plesae contact the sales agent.*

Installation of the Drain Tube

Fix the drain tube as shown in the figure.

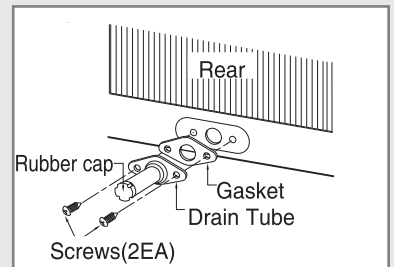



ELECTRONICS

Contact SAMSUNG WORLD WIDE

If you have any comments or questions regarding a Samsung products, contact the SAMSUNG customer care center.

Country	Customer Care Center ☎	Web Site
MEXICO	01-800-SAMSUNG (7267864)	www.samsung.com/mx
ARGENTINE	0800-333-3733	www.samsung.com/ar
BRAZIL	4004 0000	www.samsung.com/br
CHILE	800-726-7864(SAMSUNG)	www.samsung.com/cl
COLOMBIA	01 8000 112 112	www.samsung.com/co
COSTA RICA	0-800-507-7267	www.samsung.com/latin
ECUADOR	1-800-10-7267	www.samsung.com/latin
EL SALVADOR	800-6225	www.samsung.com/latin
GUATEMALA	1-800-299-0013	www.samsung.com/latin
JAMAICA	1-800-234-7267	www.samsung.com/latin
PANAMA	800-7267	www.samsung.com/latin
PUERTO RICO	1-800-682-3180	www.samsung.com/latin
REP. DOMINICA	1-800-751-2676	www.samsung.com/latin
TRINIDAD & TOBAGO	1-800-7267-864	www.samsung.com/latin
VENEZUELA	1-800-100-5303	www.samsung.com/latin
RUSSIA	8-800-200-0400	www.samsung.ru
KAZAHSTAN	8-800-080-1188	www.samsung.kz
UZBEKISTAN	140-1234	www.samsung.uz
UKRAINE	8-800-502-0000	www.samsung.com/ur
LATVIA	800-7267	
AUSTRALIA	1300 362 603	www.samsung.com/au
HONG KONG	2862 6001	www.samsung.com/hk
INDIA	3030 8282 1800 110011	www.samsung.com/in
INDONESIA	0800-112-8888	www.samsung.com/id
MALAYSIA	1800-88-9999	www.samsung.com/my
PHILIPPINES	1800-10-SAMSUNG (7267864)	www.samsung.com/ph
SINGAPORE	1800-SAMSUNG (7267864)	www.samsung.com/sg
THAILAND	1800-29-3232 02-689-3232	www.samsung.com/th
VIETNAM	1 800 588 889	www.samsung.com/vn
SOUTH AFRICA	0860 7267864 (SAMSUNG)	www.samsung.com/za