

**SAMSUNG**

# **SAMSUNG R40**



The product images may differ from actual product appearance.

## **Manual**

This manual describes how to use computer as well as information on Windows, Internet, Upgrade, and Troubleshooting.

The photographs used in this user manual may be somewhat different in shape and color to those of your computer depending on the model of your computer.

# Contents

## 1. Getting Started

Introducing the Computer .....	1-2
Turning the Computer On and Off.....	1-5
Touchpad .....	1-7
Using the Keyboard .....	1-9
Quick Launch Button .....	1-11
Status Indicators.....	1-12
Adjusting LCD Brightness.....	1-13
Adjusting the Volume .....	1-14
Proper Seating Posture During Computer Use .....	1-16

## 2. Introducing Windows

Windows XP Basics.....	2-2
Document Operations.....	2-7

## 3. Using The Computer

Using the CD-Rom Drive.....	3-2
Using the Multi Card Slot.....	3-7
Using the PC Card Slot.....	3-9
Using EasyBox.....	3-10
Using Samsung Update Plus .....	3-12

Using AVStation premium .....	3-14
Using AVStation Viewer.....	3-27

## **4. Connecting to the Internet**

Connecting to the Internet .....	4-2
Connecting to the Internet Using a Modem .....	4-3
Configuring the Network Environment Settings for Wired LAN Connections.....	4-4
Configuring the Network Environment Settings for Wireless LAN Network (WLAN).....	4-8
Using Samsung Network Manager .....	4-15
Using Network Service .....	4-22
Using Bluetooth Devices.....	4-28

## **5. System Management**

Managing Power .....	5-2
Using the Battery .....	5-4
Upgrading Memory .....	5-8
Using the Security Lock.....	5-10
Traveling with the Computer.....	5-11

## **6. Customizing your computer**

Using System Setup .....	6-2
Configuring the Password.....	6-4
Changing Booting Priority.....	6-6
Configuring Resolution and Color Depth.....	6-7
Using External Display Devices .....	6-8
Checking for Viruses .....	6-11

## **7. Recovering the Computer**

Using Magic Doctor .....	7-2
Restoring the System .....	7-3
Reinstalling Software .....	7-5
Re-Installing Windows .....	7-7
Q&A.....	7-10

## **Appendix**

System Specifications .....	A-2
Wireless LAN Specifications .....	A-3
Copyright.....	A-5
Safety Instructions .....	A-5
Samsung Notebook Computer Global Warranty	



# Chapter 1

## Getting Started

This chapter provides basic information for using this computer. System overview and methods for general use are provided.

# Introducing The Computer

## Front View

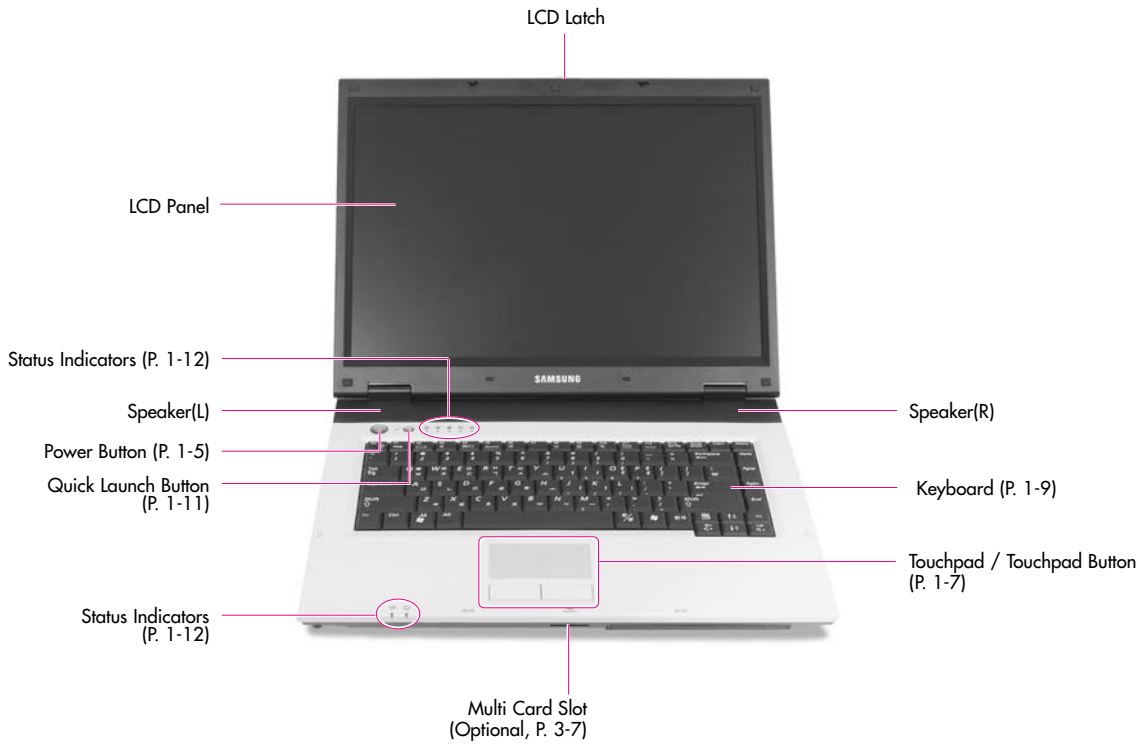

## Right View



## Left View

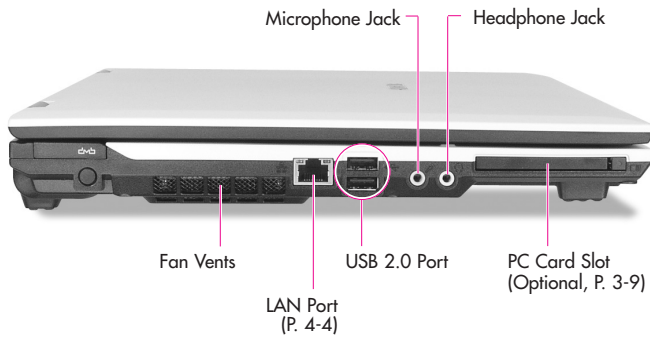



## Rear View

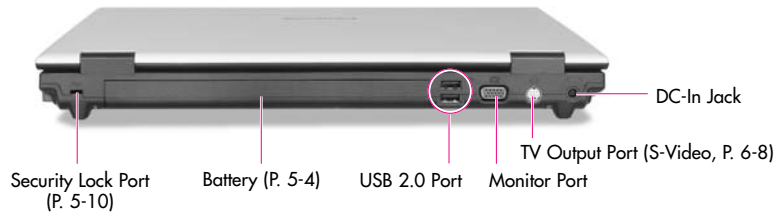

## Bottom View

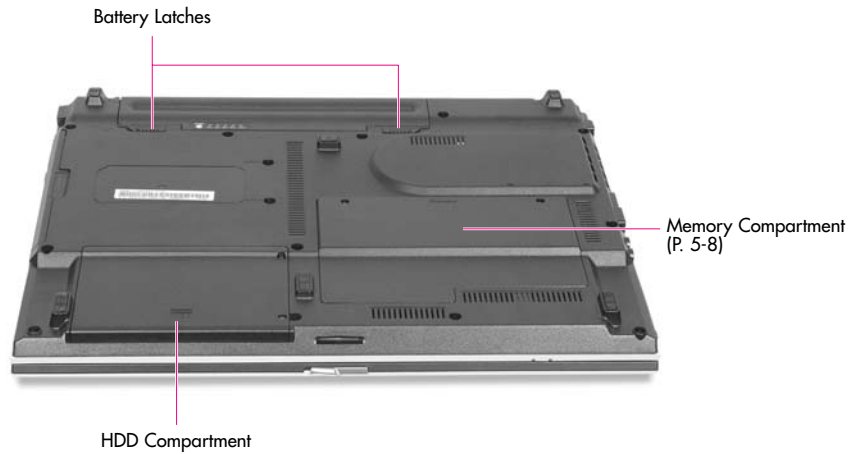

**Caution** : Removing or disassembling the hard disk drive will void your warranty. To replace the hard disk drive, please contact your nearest Samsung Service Centre.

# Turning the Computer On and Off

## Turning On

1. Insert the battery and connect the power according to the supplied Installation Guide.
2. Slide the **LCD latch** to the right and open the LCD panel.
3. Press and then release the power button to turn the system on.

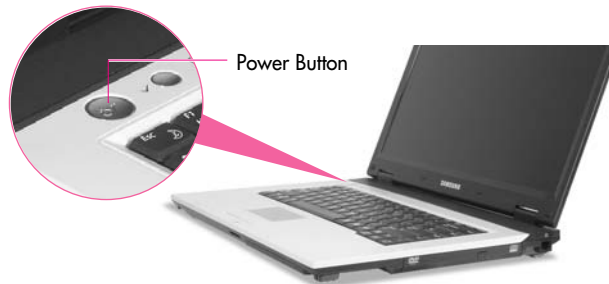

## Turning Off

1. Click the **Start** button on the Taskbar.
2. Select **Turn Off Computer**.
3. Click **Turn Off** from the [Turn Off Computer] window.



**Caution** : If the computer has not turned off properly due to a system error, press and hold the power button for more than 4 seconds to turn the system off. After doing so, when you turn the system on, the system examination program is executed automatically.

## Creating and Changing User Accounts

Multiple users can be registered in a single system so that each user may use their own customized working environment. Procedures to register and change user accounts are provided below.

### ■ Registering a new user

1. Click **Start > Control Panel**.
2. Click **User Accounts > Create a new account**.
3. Type a name for the new account, and click **Next**.
4. **Select the account type** and click **Create Account**.

The new user account has been created.

**Note** : **To login with an Administrator Account To delete a user account**

1. Click on a user account to delete and click **Delete the account**.
2. Select either **Keep Files** or **Delete Files**, and then click **Delete Account**.

### ■ Changing users

1. Click **Start > Log Off**.
2. Click **Switch User**.

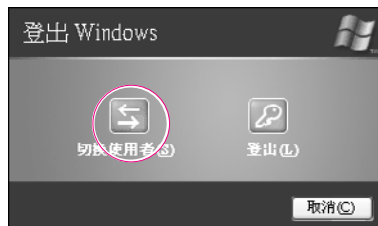

3. In the [Windows Log On] window, select the desired **user name**.

# Touchpad

Movement of the pointer (arrow) on the screen will correspond to movement made with a finger on the touchpad.



**Touchpad buttons**  
the two buttons below the touchpad provide identical functions to buttons of a mouse.

## Note : Locking the touchpad

You can lock the touchpad and use only the keyboard and mouse. To lock the touchpad function, press the **<Fn>+<F9>** key combination.

## ■ Click (Select Function)

Place a finger on the touchpad, move the pointer on the screen to the icon or item to select, and tap the touchpad once. The click operation is also used to move the 'cursor' during document operations.

## ■ Double-click (Run Function)

Place a finger on the touchpad, move the pointer on the screen to the item to run, and quickly tap your finger on the touchpad twice.  
Or double-click the left touchpad button.

## ■ Drag (Move / Select)

Drag and drop a part to the required place.



**This button is held down**  
Place the touchpad pointer on the title bar of the window.

## ■ Using the Touchpad Scroll Function

The touchpad has a scroll function, which can be used like the wheel dial of a wheel mouse. Move up and down along the right edge of the touch pad (scrolling up and down) or left and right along the bottom edge of the touch pad (scrolling left and right) to scroll the screen. However, this may not apply to some programs.

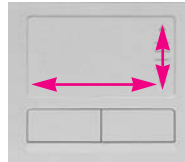







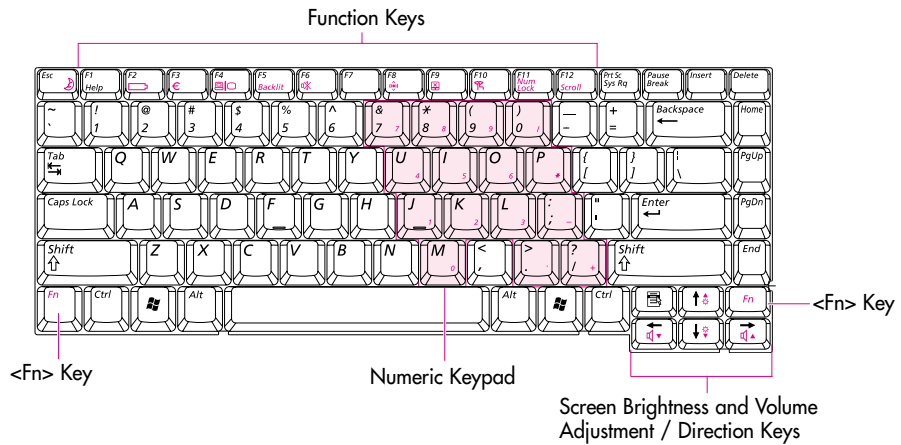

**Caution** : Please use the touchpad only with your finger. Using sharp devices may damage the touchpad.  
: Operating the touchpad or touchpad button while starting your system may increase the time required for starting Windows.







**Note** : To utilize the touchpad buttons for other more diverse functions, please refer to the Mouse icon in the Control Panel.



# Using the Keyboard



■ **Special Function Keys:** The <Fn> key activates special functions when pressed in combination with other keys.

Key Combinations	Key Name	Function
	Standby	Places the computer into standby mode. To resume from standby mode, press the power button.
	Gauge	Shows the current power source and the remaining battery charge.
	Euro	Used to type the symbol for Euro currency.
	CRT/LCD	Switches the display between the LCD and an external display device when an external display device is connected. (P. 6-8)
	Backlit	Turns the LCD on and off.
	Mute	Turns the audio output on and off.
	Wireless LAN	Turns the wireless LAN service on and off for appropriate models.
	Touchpad	Turns the touchpad function on and off.
	Etiquette Mode	You can select Etiquette Mode when you require a quiet operating environment.
		<p><b>Caution</b> :</p> <ul style="list-style-type: none"> <li>In low-noise mode, the operational speed of a program may be slowed down because the CPU operates at minimum speed, and the system may overheat</li> <li>because the fan is rotating only at low speed.</li> </ul>

 <b>Key Combinations</b>	<b>Key Name</b>	<b>Function</b>
	Num Lock	Makes the keypad in the middle of keyboard available.
	Scroll Lock	Scrolls the screen up and down while the cursor position does not change in some applications.
	Volume Up	Increases the audio volume.
	Volume Down	Decreases the audio volume.
	Brightness Up	Turns the LCD screen brighter.
	Brightness Down	Turns the LCD screen dimmer.

<b>Key</b>	<b>Function</b>
	<p><b>Screen Control Key</b></p> <p>Moves to the screen above or below, or moves the cursor to the beginning or end of the sentence.</p>
	<p><b>Windows key</b></p> <p>Display start menu.</p>
	<p><b>Application Key</b></p> <p>Provides the right button function of the touchpad.</p>

## Quick Launch Button

Using this button, you can quickly launch a frequently used program. The default application linked to this button is AVStation Viewer.

### ■ To change the application to launch using this button

1. Click **Start > All Programs > Samsung > Magic Keyboard > Magic Keyboard**.
2. Click the **Application to be launched**, select an application and click **Open**.  
Example) C:\Program Files\Internet Explorer\EXPLORE



3. Click **Apply** and then **OK** to complete the settings.



## Status Indicators

Shows the operating status of the computer.



Icon	Name	Description
	Num Lock	Turns on when the numeric keypad is activated.
	Caps Lock	Turns on when all alphabet characters you type will be in upper case.
	Scroll Lock	Turns on when it is set to scroll the screen up and down while the cursor position does not change in some applications.
	Hard Disk Drive	Quick Launch Button
	Wireless LAN	Turns on when wireless LAN function is enabled. (This light does not operate for the models without wireless LAN.)
	Charger	<p>Green - When the computer is operating on AC power and the battery is fully charged</p> <p>Amber - When the computer is operating on AC power and the battery is being charged.</p> <p>Off - When the computer is operating on battery power.</p>
	Power	<p>Turns on - when the computer is turned on.</p> <p>Blinks - when the computer is in Standby mode.</p>

## Adjusting LCD Brightness

There are 8 levels of LCD brightness (1:Dimmest~8:Brightest).

### ■ To adjust using keyboard

Press <Fn>+< > or <Fn>+< > keys from the keyboard to adjust LCD brightness.

### ■ Adjusting the brightness using the Battery Manager

You can adjust the screen brightness using the Battery Manager. (P. 5-6)

#### Note : Maintaining your LCD brightness settings after turning the system off and on

1. Turn the system on. When the **Samsung Logo** appears, press the <F2> key to enter Setup.
2. In the **Boot** menu, change the **Bright Mode Control** option to **User Control**.
3. Save the settings and exit Setup.
  - When using the Battery Manager, only the screen brightness set in 'Custom Mode' is maintained.

#### To save the battery charge

When your computer is operating on battery power, adjusting the LCD brightness level to dimmer diminishes the battery power consumption.

#### Bad pixels in the LCD

The limits of the LCD manufacturing technology allow a maximum of 10 abnormal or bad pixels, which do not affect system performance. This system may have the same level of abnormal or bad pixels as any other company's products.

#### Caution : Maintenance Instructions

When cleaning the LCD panel, use only computer specific cleaners on a soft cloth, and lightly wipe in one direction.

# Adjusting the Volume

## ■ To adjust using keyboard

Press <Fn>+<> or <Fn>+<> from the keyboard.

## ■ Using the Volume Control Program

On the taskbar, click the **Volume** () icon, and adjust the **slide bars**.

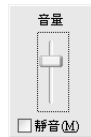

For advanced volume control options, double-click the **Volume** () icon, and adjust the settings in the [Master Volume] dialog.

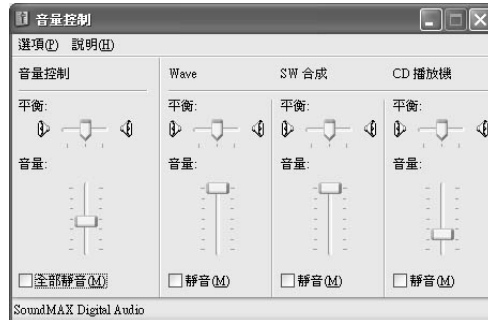

**Caution** : When you turn the system on, a booting noise may occur.

## ■ Using EDS

Enables listening to surround sound using stereo speakers.

To listen to more stereophonic sound, click **Start > All Programs > Samsung > Samsung EDS > Samsung EDS** or double-click the EDS icon () on the Taskbar and select a surround mode from the pop-up menu.

**Note** : To disable EDS, select **Enhanced Digital Sound OFF** from the pop-up menu.

## Proper Seating Posture During Computer Use

The proper seating posture during computer use is provided here. Maintaining proper posture during computer use enhances performance and prevents physical bodily harm.



If necessary, use a footrest to raise the level of your knees and ease the pressure on the thighs.



### Seating Posture

- Position the chair so that the eyes are slightly higher than the display panel.
- Straighten the neck and back.
- Place the legs naturally.
- If necessary, use a cushion to provide extra back support.
- Avoid working postures that require twisting the body or neck.



### Lighting

- Soft, indirect lighting is recommended.
- Position the display panel so that external light does not reflect off the screen. Use curtains, if necessary.



### Work Habits

- Take periodic breaks and stretch out stiff muscles regularly.
- Look outside the window or at distant objects frequently to relieve strain on the eyes.

# Chapter 2



## **Introducing Windows**

This chapter provides basic information on using the computer's main operating system Windows.

# Windows XP Basics

Windows is the computer's main operating system, which needs to be familiarized with in order for efficiently computer use.

## Windows XP Tour

A tour of the elementary functions provided by Windows XP.

Click **Start > Tour Windows XP**.

Or click **Start > All Programs > Accessories > Tour Windows XP**.

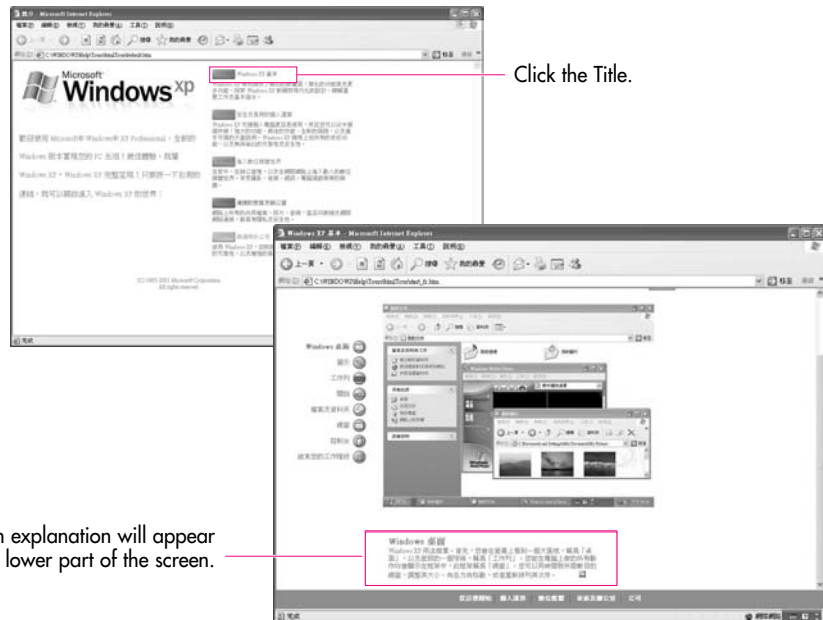

Click on the topics to find out about important functions of Windows XP.

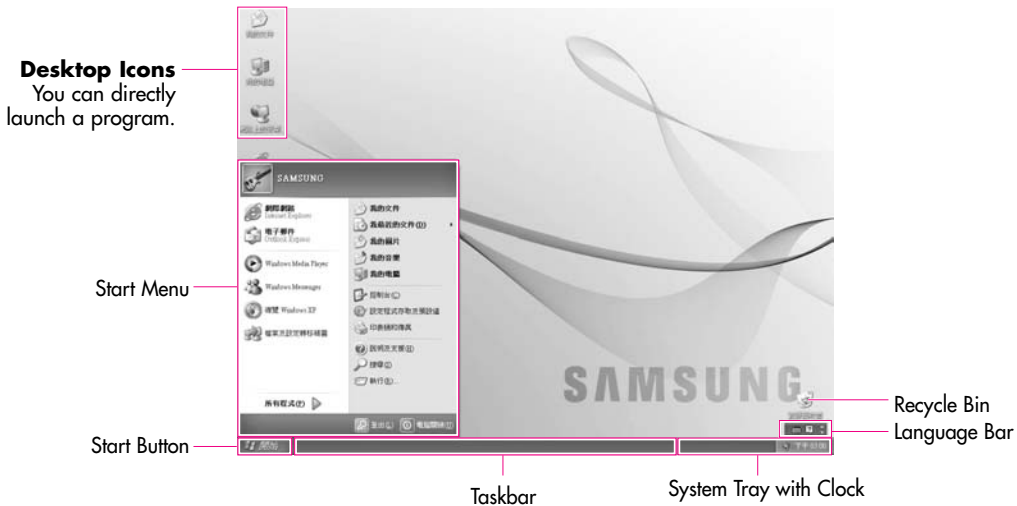

# Understanding the Desktop

The Desktop is the working area on the computer. It consists of the large workspace, which is more or less the entire the screen and a Taskbar at the bottom.



Start Button		Opens the Start Menu.
Taskbar		Displays programs that are currently running. Frequently used icons can be placed here.
Recycle Bin		Deleted files or folders end up here.
Language Bar		Enables switching between English/other languages text inputs and provides other text input services.







## Understanding the Start Menu

The Start Menu includes everything that is required to start Windows.

From the Start Menu it is possible to run a program, open a file, assign system users with the Control Panel, receive support by clicking Help and Support, and search desired items from computer or Internet by clicking Search.



My Computer		Displays the contents of the hard disk, the CD-ROM drive, the network drive, and floppy disks. It can also be used to search and open files and folders.
Control Panel		Enables users to configure settings on the computer.
Help and Support		Provides on-line help, information on Windows and troubleshooting.
Search		Enables users to search for information in files or the Internet.
Run		Runs programs or documents.

# Understanding a Window

A window is the basic component in working with the computer. The My Computer window, which is a window for the computer's hard drive, will be used as an example here to show the basic composition of a window.

Click **Start > My Computer**.

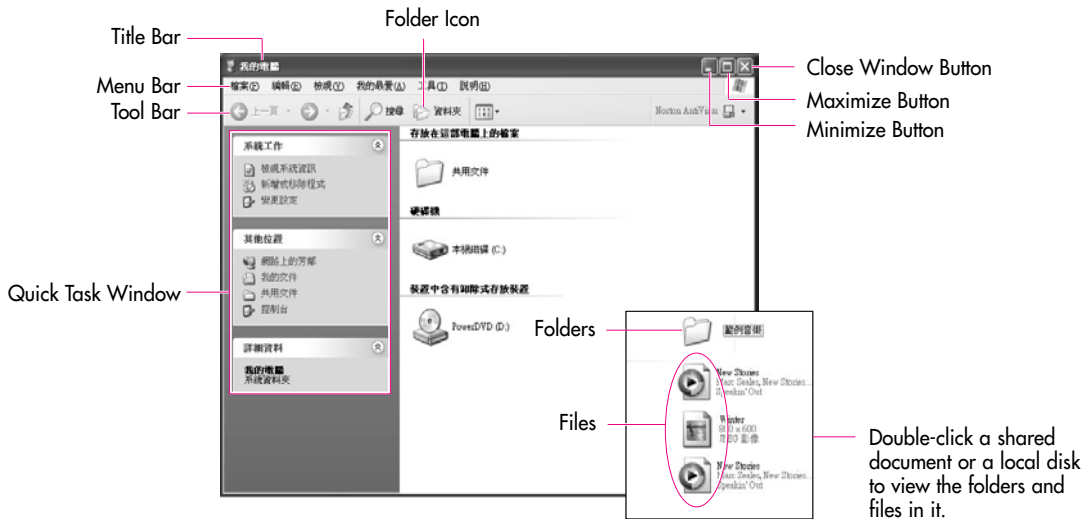

Double-click the hard drive (local disk) to view internal folders and files stored in it. If the contents do not appear, click Show Contents.

- Note**
- **What is a Drive?** A storage device in which files and folders are saved in, and read from.
  - **What is a Folder?** A folder is used to group and manage files systematically, and may include files in sub-folders. It is similar to a bookshelf.
  - **What is a File?** A file is a document or various kinds of material that is generated as a result of program operation. It is also called data.

### To view the entire structure of the drive

Click the Folder Icon in the Toolbar to view the entire structure. Click again to return to the Quick Task Window.

# Help and Support Center

Help and Support Center provides references and troubleshooting information regarding computer use.

Please refer to help and support centre before calling the Samsung helpline.

Click **Start > Help and Support**.

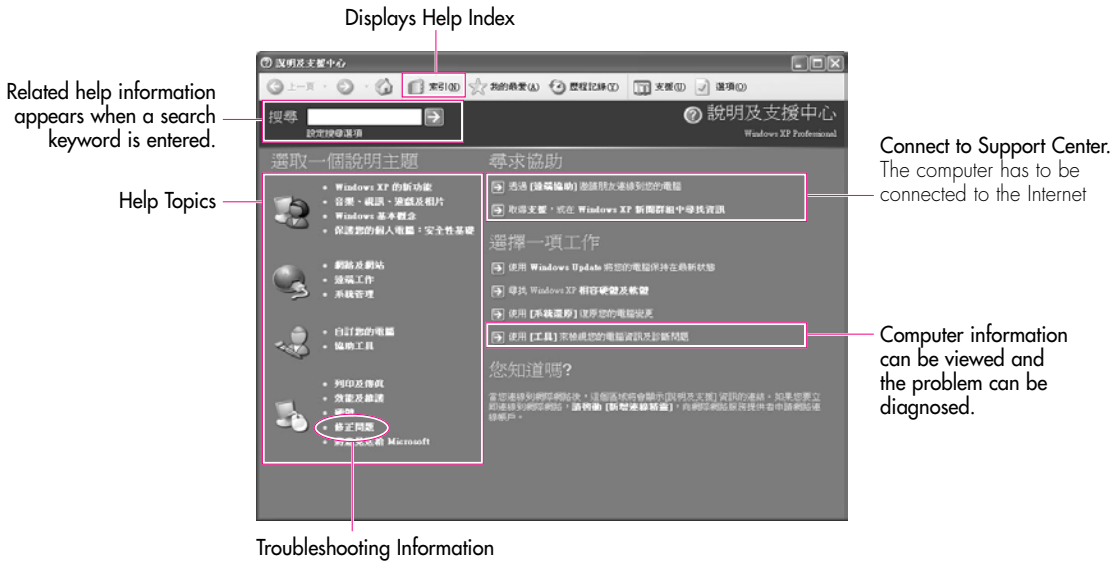

# Document Operations

To create documents, WordPad or NotePad, which is included in Windows, or a separate specialized word processor program can be used, such as MS Word.

Instructions for creating documents using WordPad is provided here.

## ■ Creating a New Document

1. Click **Start > All Programs > Accessories > WordPad**
2. Create and edit your document. For more information about WordPad, refer to on-line Help.

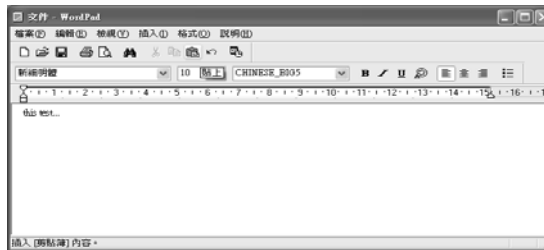

## ■ Saving a Document

1. Select **File** from the Menu, and click **Save**.
2. Click on the Save in field to specify a folder to save the file in, enter the name of the file in the File Name field, and click **Save**.

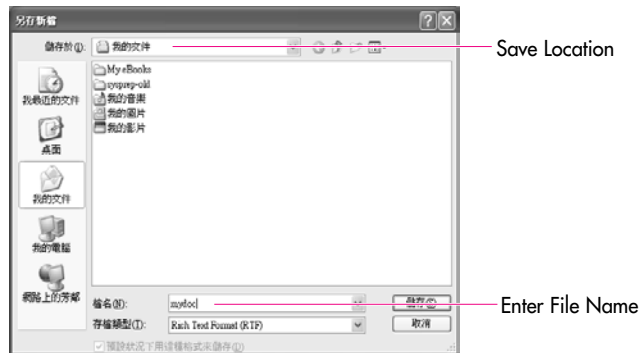

## ■ Opening a Document

1. Click **Start** > **All programs** > **Accessories** > **WordPad**.
2. Select **File** From the Menu, and click **Open**.
3. Click on the Look in field and specify the folder in which the file is saved.
4. Select the file to open and click **Open**.

## ■ Printing a Document

To print a document, connect a printer to the computer.

For more information about connecting and configuring a printer, please refer to the printer manual.

To print a WordPad document

1. Turn on the printer, and insert paper.
2. Open the WordPad file to print.
3. Select **File** from the Menu and select **Print**.
4. Click **Properties**, adjust the printer options accordingly, and click **OK**.
5. In Print window, click **OK** to print the document.

# Chapter 3



## Using The Computer

This chapter investigates various different functions of the computer and provides information on using the related application programs for them.

## Using the CD-ROM Drive

This computer has one of the following CD drives.

- CD-ROM Drive Reads CDs.
- RW-Combo Drive Read a CD/DVD, and writes data onto a CD.
- DVD Super Multi Drive Reads CD/DVDs and writes data to CD/DVDs. Supported DVD types include DVD±R, DVD±RW and DVD-RAM.

**Note** : A CD-ROM drive is optional. For more detailed product specifications, refer to the product catalog.

1. Press the **Eject** button on the side of the CD drive.
2. When the tray slides out, place a CD onto it and push down until it clicks.



3. Push the CD tray in gently. The CD will run automatically.

**Note** : To eject a CD when the CD drive is out of order or the system is turned off, unfold a paper clip, and insert the unfolded end of the clip into the hole (  ) and press until the CD tray opens.

**Caution** : To clean a CD or DVD title, clean the disc with a soft clean cloth by wiping from the center outwards.  
Do not eject the CD while the Status Indicator is on.

## Using the Windows Media Player

Windows Media Player enables you to play and manage audio and video files.

Click **Start > Windows Media Player**.

Or click **Start > All Programs > Accessories > Entertainment > Windows Media Player**.

Running the program the first time displays the set up screen. Define the settings according to the instructions displayed on the screen.

When you complete the settings, the following screen appears.

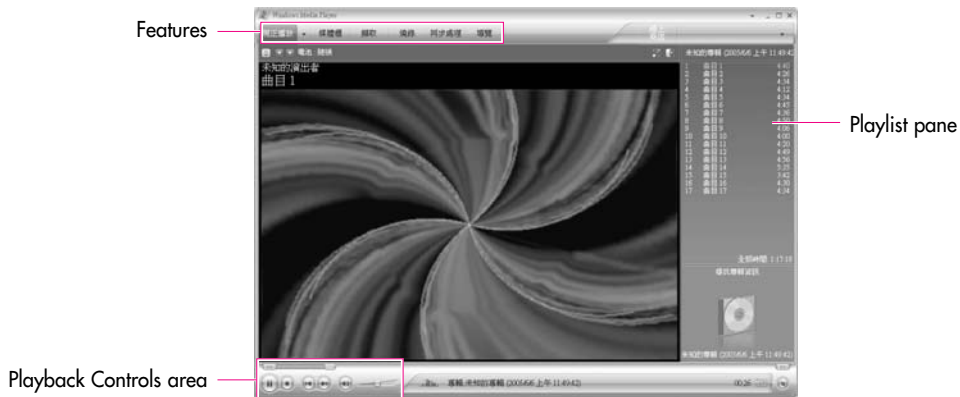

**Note** : To view detailed information on how to use Windows Media Player:  
Run Windows Media Player and right-click over the Function Taskbar and select  
**Help > Windows Media Player Help**



## To Play an Audio CD

1. Insert an audio CD into the CD drive, and a list of all available players is displayed automatically.
2. Select **Windows Media Player**, and click **OK** to play the audio CD.

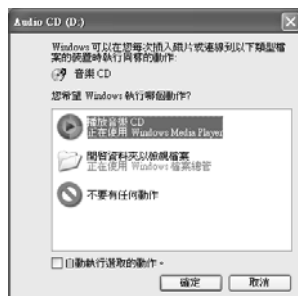

## To Play a Video CD

1. Insert a video CD into the CD drive.
  2. When a video window appears, double-click the **MPEGAV** folder.
  3. Double-click the **DAT** file.
  4. When a warning window appears, click the **Open with** button.
  5. In the new window, click **Select Program from List** and click **OK**.
  6. Select the **Windows Media Player**, and click **OK**.
- The video will start playing.



## To Write Data in CD

If your computer has CD-RW functionality, you can copy data to a blank CD or create an audio CD.

1. Insert a blank CD into the CD-RW drive.
2. Click **Open Writable CD Folder** and click **OK**. The CD-ROM drive window appears automatically.

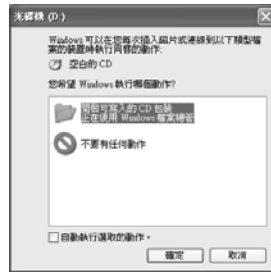

3. Click **Start > My Computer**.

- Select, drag and drop folders or files to copy onto the CD-ROM drive window. Click **Write Files to CD** in the CD-ROM drive window.

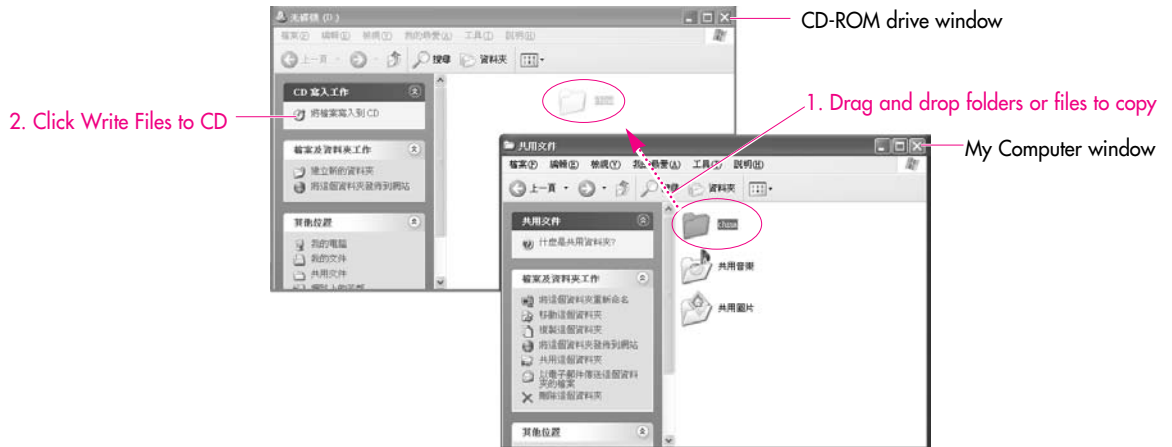

- When the CD Write Wizard appears, enter the **CD label**, and click **Next**. The data will begin copying.
- When copying is completed, a 'completed' message will appear and the CD-ROM drive will open automatically.

**Note** : **For more information on copying CDs**

- Click Start > Help and Support. Enter [CD copy] in the search field, and click the Search button.

**To Burn an Audio CD:**

- Run Windows Media Player and right-click over the Function Taskbar and select **Help > Windows Media Player Help** from the popup menu.
- Select **Using the Player > Using CDs, DVDs and VCDs > Using CDs > Burning your own CD > To burn your own CD** to see detailed information.

## Using the Multi Card Slot

Using the Multi-Card Slot, you can connect a Memory Stick, Memory Stick Pro, SD Card, MMC, High Speed MMC or xD Card. A memory card is used as a removable disk and is useful for exchanging data between a computer and a digital device such as a digital camera.

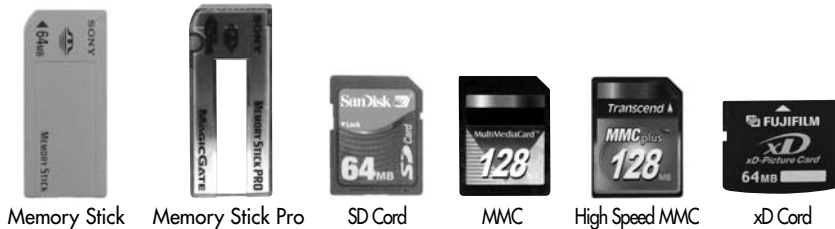

### Note : To protect the data in the memory card

Set the write protection tab of the Memory Stick or SD memory card to the Lock position.

### Caution : Restrictions on Using Memory Cards

You can use memory cards for storing data only. Copyright protection function is not supported.

## ■ To insert and use a memory card

1. Insert a memory card into the Multi Card Slot.



(ex: Memory Stick)

2. Click **Start > My Computer**. The inserted memory card is displayed.



MemoryStick (E:)  
(ex:Memory Stick)

3. You can write data to the memory card. If the memory card is not formatted yet, format the memory card before use.

**Caution** : Since the memory card may be easily mislaid when moving your computer, keep the memory card separately.

## ■ To remove a memory card

1. Press the end of the memory card softly to pop it outward.
2. If the card pops out with a clicking sound, remove the card from the system.

## ■ To format a memory card

You can use a memory card after the format operation. The procedures to format a memory card are described below.

**Caution** : Since format operation deletes all data in the memory card, please make sure that there is no important data in the memory card before formatting.

### **Note** : To protect the data in the memory card

: Set the write protection tab of the Memory Stick or SD memory card to the Lock position.

1. Click **Start > My computer**.
2. Press the right touchpad button on the memory card drive, and select **Format** from the pop-up menu.
3. Click **Start** to start the format operation.

**Caution** : To use a memory card in both the computer and other digital device such as digital camera, it is recommended to format the memory card in the digital device. If you format the memory card in the computer, you may have to format the memory card in other digital device again to use the memory card in the digital device.  
: If you format the memory card in the computer, you may have to format the memory card in other digital device again to use the memory card in the digital device.

## Using the PC Card Slot

Various different functions can be added by inserting PCMCIA cards into the system. This system supports 32 bit, type I or II PCMCIA card types.

**Caution** : Before using the PCMCIA slot, remove the slot protector.  
: Push the eject button of the PCMCIA card slot once to pop it out. Push the button again to eject the slot protector.

1. Insert a card into the PCMCIA card slot on the side of the system.



2. When a card is inserted, Windows automatically installs the necessary driver for the card. If no available driver can be found by Windows, the driver has to be installed using the disk supplied with the card.

**Note** : To remove PCMCIA card  
: a. Double-click Safely Removes Hardware icon (  ) in Taskbar.  
: b. Select the appropriate PCMCIA card and click Stop button.  
: c. When 'Safe to remove Hardware' window appears, click OK.  
: d. Press Eject button at PCMCIA card slot once, then the button pops out.  
: e. Press the projected button to eject the PCMCIA card.

**Caution** : You cannot use a ZV card and a PCMCIA III card through the PCMCIA card slot of the system.

## Using EasyBox

Use EasyBox program to make use of Windows' complicated function easily and conveniently.

### Learn about EasyBox

Double-click the **EasyBox** (  ) icon on the desktop.

(Or select **Start > All Programs > Samsung > EasyBox > EasyBox.**)



- ▶ **System** : System management features are available, including disk defragmenter, removing unnecessary files/folders, computer scheduling and system recovery.
- ▶ **BIOS** : In windows-based mode, you can recover the BIOS defaults and change the boot sequence.
- ▶ **Desktop** : Desktop management features include changing the font size, executing a magnifier function, the start menu settings and managing the quick launch icons on the taskbar.
- ▶ **Security** : Here you can configure the security settings supported by Windows XP SP2. You can also change the configuration of the firewall settings, Windows automatic updates and blocking pop-ups when connected to the Internet.
- ▶ **Plus Tip** : This is a collection of additional Windows functions that are useful for system management. (Offering shortcut descriptions of Windows, configuring network sharing and opening local folder sharing, etc.)

## Using EasyBox

The security management function will be used as an example here to show the function of Easybox

### ■ Configuring Firewall

The Windows Firewall prevents unauthorized users from gaining access to your system via the network or the Internet.

1. Click **Start > All Programs > Samsung > EasyBox > EasyBox**.
2. Click **Security** from the top menu bar.
3. Select **Windows Firewall Settings** from the Security menu on the left.
4. Select a firewall level.
5. Click **Apply**.



Click the User Setting button for advanced features, including exceptions and permissions.



## Using Samsung Update Plus

Samsung Update Plus is software that examines and updates Samsung software and drivers installed on your Samsung computer to the latest version. To use Samsung Update Plus, your computer has to be connected to the Internet.

### ■ To Update Samsung Software and Drivers

1. Select **Start > All Programs > Samsung > Samsung Update Plus > Samsung Update Plus**.

**Note** : If this is the first time you are running the program, a window will appear asking you if you agree to the agreement in the window.  
: Click Agree to use this software.

2. Click **Search for and Install Updates** and click the **Search for Updates** button.



3. If there are available software or driver updates for your computer, the available updates will be listed. Select the required updates from the list and click Install Update to start the update.



(The update list on the screen may differ depending on the computer model.)

**Note** : **Updates that must be installed separately.**

If you select an update that must be installed separately, a message appears informing you of this. Follow the instruction message to correctly install it.

**Automatic update items display**

By default, your computer is configured to automatically search for updates. If there is a new update available, this is notified in the notification area. Click the balloon help icon in the notification area. Here you will be able to find the latest available updates.



To change the automatic update settings, click the Custom button in Figure 2 and change the settings.

: Samsung Update Plus does not provide updates for additionally installed software and device drivers.

## Using AVStation premium

AVStation premium is an integrated multimedia program that enables users to enjoy music, photographs, video, movies, etc. all with a single program.

- Note**
- AVStation premium is optional and may not be provided depending on the model.
  - The screens used in this manual may differ from actual screens according to the program version.
  - **TV Station is only available for systems supporting the TV function.**
  - For detailed usage, refer to the program help.

### Start and Screen Layout

To launch the program, select **Start > All Programs > Samsung > AVStation premium > AVStation premium**.

Alternatively double-click the AVStation premium icon (  ) on the Desktop.



- **MUSIC :** You can play a music file or an audio CD.
- **PHOTO :** You can view or edit a photograph (image), and also view the photographs through a SlideShow.
- **MOVIE :** You can play a video (movie) file or a DVD/VCD title.

# MUSIC Station

Launch AVStation premium and click **MUSIC** on the Station Bar.



## Note : What is EDS (Enhanced Digital Sound)?

- EDS (Enhanced Digital Sound) is a sound quality enhancement technology developed by Samsung Electronics. You can listen to clearer sound if you enable the EDS function when playing music or video on AVStation premium.

## ■ Playing an Audio CD

The procedures to play an audio CD are described below.

1. Launch AVStation premium and insert an audio CD into the CD drive.
2. In the **Audio CD** window, select **Play Audio CD using Samsung AVStation** and click the **OK** button.



3. The tracks on the audio CD are displayed in the Playlist and the first track is automatically played.



**Note** : If an audio CD is already in the CD drive, double-click the **album title** in the **Audio CD** folder of the Library and add the tracks to the Playlist. The tracks added to the Playlist are played.

## ■ Playing a Music File

If a music file is registered to the MUSIC Library, you can easily play the music file.

For the procedures to register tracks to the Library, refer to (P. 3-18).

1. Move to **MUSIC Station** and double-click on **All Music**.
2. Double-click a music file. The file is added to the playlist and played.



**Note** : **Play a Track not registered to the Library**  
• Click **File > Open**, select a music file to be played and click **Open**. The selected track is registered to the Library and played.

- **Creating My Playlist**  
• My Playlist is a personal album with which you can collect, manage and play your favorite music files. For the procedures to create My Playlist, refer to the descriptions of MUSIC Station in Help.

## ■ Adding Music Files to the Library

MUSIC Library is a library holding music files used by MUSIC Station. The procedures to add music files saved on the computer to the Library are described below.

You can add files, folders or search and add files. As an example, the procedures to add a folder are described below.

1. Click on the **Register a File** () button below the Library and click on **Add by Folders**.



2. Select a folder which included music files and click the **OK** button. The music files in the folder are added to the Library.



**Note** : The tracks used in AVStation are automatically added to the Library.

# PHOTO Station

Launch AVStation premium and click **PHOTO** on the Station Bar.

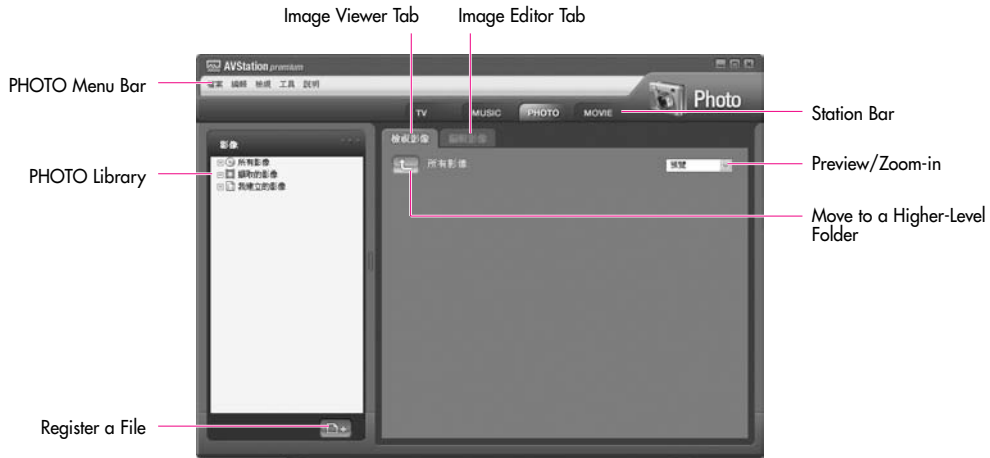

## ■ Viewing an Image

The procedures to view images registered to the PHOTO Library one by one and through a SlideShow are described below.

For the procedures to register image files to the Library, refer to (P. 3-22).



1. Move to **PHOTO Station** and double-click on **All Images**.
2. Click on a folder which includes images, and the images in the folder are displayed in the Image Viewer window.





3. Double-click on an image. The selected image is zoomed in on.



- **Viewing an Image not registered to the Library**  
Click **File > Open**, select an image file to view and click **Open**.  
The selected image file is registered to the Library and displayed in the Image Viewer window.
- **Viewing an Image in Full Screen or through a SlideShow.**  
Click the **Full Screen** (  ) button or **SlideShow** (  ) button below the Image Viewer window.  
Run Full Screen View and you can rotate the picture using the direction keys.  
To return to the Image Viewer window, press the <Esc> key or double-click on the screen.
- **Watching a SlideShow while Listening to Music**  
To watch a SlideShow while listening to music, play music from MUSIC Station and run SlideShow.
- **Setting an Image as the Background.**  
Click the **Set as Background** (  ) button below the Image Viewer window. The selected image is set as the Desktop background.

## ■ Editing an Image

You can change the shape of an image, edit an image or apply special effects to an image. The image editor functions are described below.

1. Select an image to edit in the **Image Viewer window**, and select the **Image Editor** tab. The Image Editor screen appears.

The Image Editor screen consists of an **Image Workspace window** and **3 Tool tabs**.



2. Edit the image using the Shape, Edit and Effect tools.

- **Shape tool :** Change the shape of an image through cut, resize.
- **Edit tool :** Draw a line, add some clip art or enter letters.
- **Effect tool :** Apply various effects to an image.

3. When finishing editing an image, click the **Save Edited Image** (  ) button below the Image Editor window. The edited image is saved.

## ■ Adding Images to the Library

The PHOTO Library is a library holding image files to be used by PHOTO Station. The procedures to add image files saved on the computer to the Library are described below.

You can add files, add folders or search and add files. As an example, the procedures to add folders are described below.

1. Click the **Register a File** (  ) button below the Library and click on **Add by Folders**.



2. Select a folder which includes image files and click the **OK** button. The image files in the folder are added to the Library.

**Note :** The image files used in AVStation are automatically added to the Library.

## MOVIE Station

Launch AVStation premium and click on **MOVIE** on the Station Bar.



### Note : What is EDI (Enhanced Digital Image)?

- EDI (Enhanced Digital Image) is a visual quality enhancement technology developed by Samsung Electronics. You can view a clearer and sharper picture by enabling the EDI function when watching TV or playing a video on AVStation premium.
- However, some TV tuners and graphics cards are not supported by EDI.
- For information on EDS (Enhanced Digital Sound), refer to P. 3-15.

## ■ Playing a DVD

The procedures to play a DVD title are described below.

**Note** : To play a DVD title, DVD playing software (e.g. CyberLink PowerDVD) must be installed. Install the DVD playing software first.

1. Launch AVStation premium and insert a DVD title into the DVD drive.
2. In the 'What do you want Windows to do?' window, select **Play DVD Video using Samsung AVStation** and click the **OK** button.

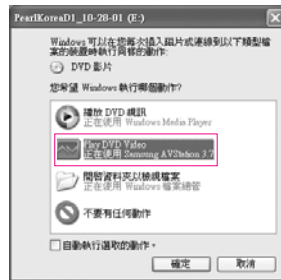

3. The DVD title is played.



**Note** : If a DVD title is already in the DVD drive, double-click the **DVD title** in the **DVD / VCD** folder of the Library. The DVD title is played.

## ■ Playing a Movie(Video) File

The procedures to play a video file registered to the MOVIE Library are described below. For the procedures to register files to the Library, refer to P. 3-26.

1. Move to MOVIE Station and double-click **All Movies**.
2. Double-click a video file. The file is played.



### • **Playing a Video File not Registered to the Library**

Click **File > Open**, select a video file to be played and click **Open**. The selected file is registered to the Library and played.

### • **Playing a Video File in Full Screen**

- 1) Double-click on the current playback screen.
- 2) The video is played in full screen. In full screen, move the mouse pointer to the bottom of the screen to show the Play Control bar.

To play at the default screen size, press the <Esc> key or double-click on the screen.

### • **Capturing the Video Screen**

Click on **Capture Current Screen** (📷) below the Play window when the desired image appears on the screen and click the **OK** button.

Captured images are saved in the **C:\Program Files\Samsung\AVStation Premium 3.75\Data\Captured Images** folder.

In addition, you can view captured images in the **PHOTO Station > Captured Images** folder.

## ■ Adding Videos to the Library

The MOVIE Library is a library holding video files to be used by MOVIE Station. The procedures to add video files saved on the computer to the Library are described below.

You can add files, add folders or search and add files. As an example, the procedures to add folders are described below.

1. Click the **Register a File** (  ) button below the Library and click **Add by Folders**.



2. Select a folder which includes video files and click the **OK** button. The video files in the folder are added to the Library.

**Note** : The video files used in AVStation are automatically added to the Library.

## Using AVStation Viewer

This is a multimedia program that can play music, photos, video, movies, etc. in full screen.

- Note** :
- The AVStation Viewer program is optional and may not be provided depending on the computer model.
  - **AVStation Viewer Restrictions**  
Using AVStation Viewer, you can only play files registered to the AVStation premium Library. (For the procedures to register files to the Library, refer to P. 3-18, P. 3-22 and P. 3-26.)
  - The screen figures may differ from actual ones depending on the program version.
  - TV Station is only available for systems supporting the TV function.

## Start / Exit AVStation Viewer

### ■ Starting

Select **Start > All Programs > Samsung > AVStation premium > AVStation Viewer** from Windows.

### ■ Exiting

Move the mouse pointer to the top of the screen and click the **Exit (X)** button.





## ■ Screen Layout



- **MUSIC :** You can play a music file or audio CD.
- **PHOTO :** You can view a photograph or image file one by one or in a SlideShow.
- **MOVIE :** You can play a video, DVD or VCD title.
- **Settings :** You can set the Music, Photo and Movie settings.

**Note** : To move to the start screen while using the program, press the <ESC> key.  
Or, move the mouse pointer to the top left in the current screen and click the AVStation icon (  ).

## MUSIC Station

The procedures to play a music file or an audio CD are described below.

### ■ Playing a Music File

The procedures to play a music file registered to the MUSIC Library are described below. (For the procedures to register files, refer to P. 3-18.)

1. Launch AVStation Viewer and click on **Music**.
2. Click on **All Music** and double-click a file in the right pane.

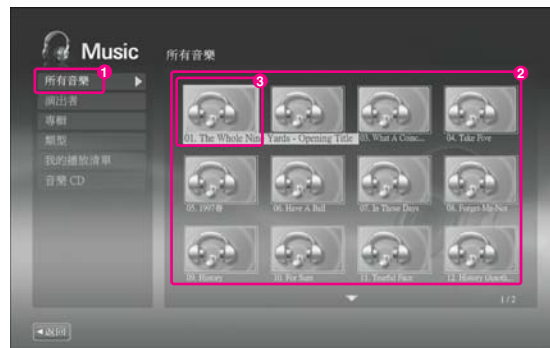

- 1 All Music
- 2 Playlist Window
- 3 Music File

### ■ Playing an Audio CD

1. Launch AVStation Viewer and insert an audio CD into the CD drive.
2. In the AVStation Viewer start screen, click on **Music**.
3. Double-click the **Audio CD** in the left pane and double-click on an album or music file in the right pane. The selected music file is played.



## PHOTO Station

The procedures to view images registered to the PHOTO Library one by one and through a SlideShow are described below.  
(For the procedures to register image files to the Library, refer to P. 3-22.)

1. Launch AVStation Viewer and click on **Photo**.
2. Click on All Images and double-click on an image file in the right pane.



- 1 All Images
- 2 Image File

3. The selected image is zoomed in on.



- Note** :
- To view an image in Full Screen or through a SlideShow.
  - Click on the SlideShow or Full Screen button below the zoomed in image.
  - To return to the previous status in SlideShow or Full Screen, press the <Esc> key or double-click on the screen.
  - In AVStation Viewer, press the <Esc> key or double-click and click **Back**.

## MOVIE Station

The procedures to play a video (movie) file or DVD/VCD title are described below.

### ■ Playing a Movie File

The procedures to play a video file registered to the MOVIE Library are described below. (Refer to P. 3-26.)

1. Launch AVStation Viewer and click the **Movie**.
2. Click on **All Movies** and double-click a movie file in the right pane.  
The movie file is played.

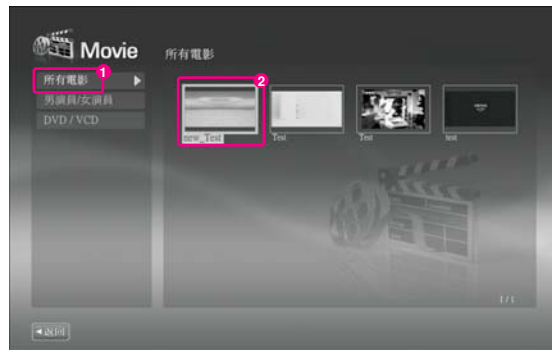

### Note : Showing the Play Control window

- Press the **space bar** or move the mouse pointer. The Play Control window appears at the bottom.

## ■ Playing a DVD

1. Launch AVStation Viewer and insert a DVD title into the DVD drive.
2. In the AVStation Viewer start screen, click on **Movie**.
3. Click on **DVD/VCD** and double-click on the DVD title. The DVD title is played.



# Chapter 4

## Connecting to the Internet

This chapter provides instructions on connecting to the Internet.

## Connecting to the Internet

The following options show many ways to connect to the Internet. An appropriate option should be selected depending on the user's working environment and the user's system specifications.

### Option 1 Connecting using a modem and a telephone line.

Service has to be applied for and received from an Internet Service Provider (ISP) through an Internet service account.

### Option 2 Connecting using a High-speed communication network service, such as ADSL and VDSL.

Service has to be applied for and received from a High-speed communication network service provider. Receiving Internet service may require support from specific devices. Contact the service provider for details.

### Option 3 Connecting using a wired LAN

Use a LAN cable that is already installed in your office or building,

### Option 4 Connecting using a wireless LAN

The Internet can be accessed without a telephone line or a LAN cable if there is a Wireless LAN AP (Access Point) nearby.

**Note :** The Wireless LAN function is optional.

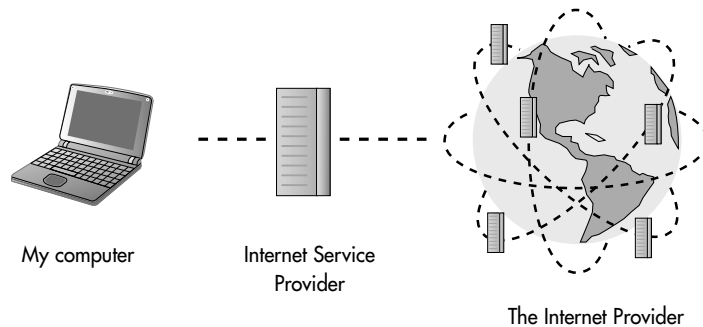

## Connecting to the Internet Using a Modem (Optional)

1. Connect the telephone line to the modem port.



**Caution** : Do not connect a digital phone to the Modem Port. The high voltage may damage the modem.

2. To connect the modem to the Internet, and use e-mail, you have to apply to an Internet Service Provider (ISP) for an Internet service.

**Note** :

- For more account information, please contact your ISP.
- Ask your ISP about Internet fees and the disconnection procedure. If the Internet connection is not disconnected properly, additional telephone charges may incur.



## Configuring the Network Environment Settings for Wired LAN Connections

A wired LAN environment is an environment where you can connect to the Internet using the company's LAN or with a broadband modem.

1. Connect the network (LAN) cable to the LAN port of the system.



2. Click **Start > Control Panel**.
3. Select **Network and Internet Connections** in the [Control Panel] window.
4. Click **Network Connections** in the [Network and Internet Connections] window.
5. In the [Network Connections] window, point the mouse pointer to Local Area Network and click the right touchpad button. Select **Properties** from the popup menu that appears.



6. In the General tab of the [Local Area Connection Properties] window, check that the connecting device field includes the **Broadcom xxxxx (BCM xxxxx) Integrated** driver.

- In the “This connection uses the following items” field, select **Internet Protocol (TCP/IP)**, and click **Properties**.

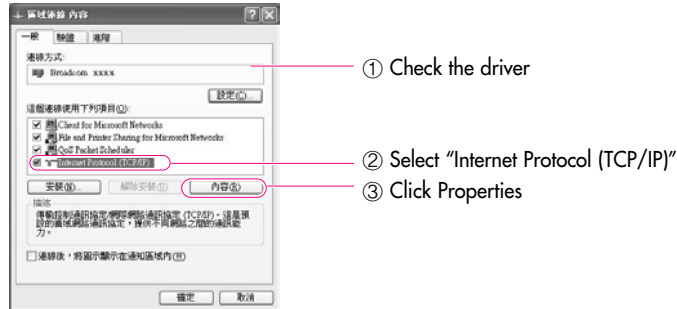

**Note** : In the above screen, necessary network components can be added by clicking the Install button.

- Enter the system’s IP and DNS server addresses on the General tab of the [Internet Protocol (TCP/IP) Properties] window. If DHCP is used, click “Obtain an IP address automatically” and “Obtain DNS server address automatically” on the General tab.



**Note** : IP addresses and other information necessary for configuration can be obtained from the network administrator.

- Once all of the information is entered in the [Internet Protocol (TCP/IP) Properties] window, click **OK** to finish.

## Using Both DHCP and Static IP Simultaneously

When you are alternatively using networks with either DHCP or static IP addressing, you can use alternative settings that enable simultaneous configurations of DHCP and static IP to use both of the network connections without reconfiguring.

**Note** : This function is provided only when your operating system is Windows XP.

1. Click **Start > Control Panel > Network and Internet Connections > Network Connections > Local Area Connection**, press the right button of the touchpad, and then select **Properties**.
2. Select the **Internet Protocol (TCP/IP)** item, and then click **Properties**.
3. In the **Alternate Configuration** tab, click **User configured**, and then enter the appropriate values for the following:

(IP address, Subnet mask, Default gateway, Preferred and alternate DNS server, Preferred and alternate WINS server)

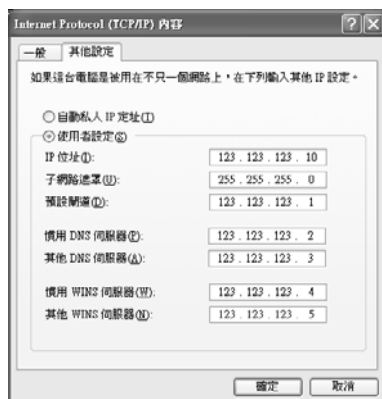

4. When the configuration has been completed, click **OK**.  
Now you can connect to both networks using DHCP and static IP respectively.

## To utilize the maximum network performance.

Configure the following settings network to utilize the maximum network performance.

1. Click the **Start > Control Panel > Performance and Maintenance > System > Hardware** tab and then the **Device Manager** button.
2. Select **Realtek RTL8139/810x Family Fast Ethernet NIC** in the Network adapters, right-click it and select **Properties**.
3. Select the **Advanced** tab, select the **Optimal Performance** in the **Properties** field and set the **Value** field to **Enable**.

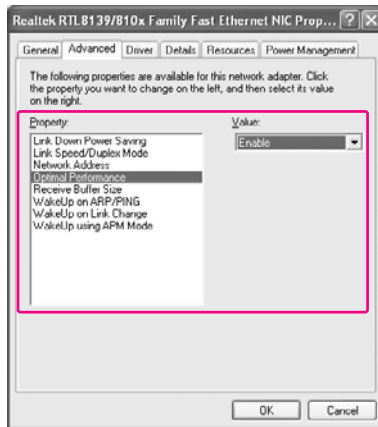



4. Click the **OK** button.

## Configuring the Network Environment Settings for Wireless LAN Network (WLAN)

A wireless network (Wireless LAN) environment is a network environment that enables communication between multiple computers at home or a small-size office through wireless LAN devices.

When a computer-to-computer network has been established, a computer that is not connected to the Internet can share the Internet by accessing another computer connected to the Internet. (See P. '4-18. Sharing Internet Access')

- Note** :
- A wireless LAN card is optional. The model of the wireless LAN card is determined by the relevant product.
  - To view the installed wireless LAN card, click Start > Control Panel > Performance and Maintenance > System > Hardware tab > Device Manager.
  - The wireless LAN connection settings will be described on the basis of the Windows XP Service Pack 2 installed computer.
  - It is recommended using the default settings provided by Windows XP for the wireless LAN settings for Windows XP installed computers. To setup using the software supplied by the wireless LAN card manufacturer, refer to p.4-14 'Wireless Network Setup Using the Wireless LAN Setup Program'.
  - To use a wireless LAN, press the <Fn> and < > key combination simultaneously to enable a wireless LAN. When the wireless LAN is enabled, the **Wireless LAN Operation LED** ( " ") lights up.

Wireless network connections can be classified into two categories.

### 1) Access Point

You can connect to an AP to use the network. This is possible only in an environment equipped with an AP. (See P. 4-9, 'Connecting to an Access Point (AP)')

- Note** :
- What is an Access Point (AP)?**
- An AP is a network device that bridges wired and wireless LANs, and corresponds to a wireless hub in a wired network. You can connect multiple wireless LAN installed computers to an AP.

### 2) Computer-to-computer (ad hoc)

This is also called a peer-to-peer network.

In computer-to-computer wireless networks, you can wirelessly connect 2 or more computers that have wireless LAN modules. (See P. 4-10, 'Connecting to computer-to-computer networks (peer-to-peer or ad hoc)').

## Connecting to an Access Point (AP)

This section describes how to connect to an AP. You can use the network when you are connected to an AP.

**Note** : For more detailed information such as the network key (encryption key), ask your network administrator.

1. Right-click on the **Wireless Network Connection** (  ) icon on the taskbar, and select **View Available Wireless Networks**.

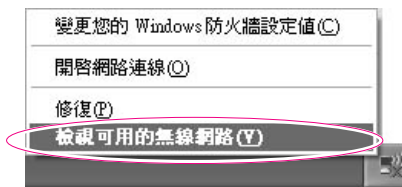

2. Select an AP (E.g. Test) to connect to and click **Connect**.  
If there is a configured network key for the AP to connect to, the Enter Network Key window appears.  
Enter the **Network Key** in the window and then click the **Connect** button.



**Note** :

When a network key is not defined for a selected AP, click on Link to display the warning message box. Then click Connect again in the box.

Now when Connected in AP is displayed, and you can access the network.

**Note** : **Checking the connection status.**  
Move the mouse pointer over the **Wireless Network Connection** (  ) icon on the taskbar, and the connection status is displayed.

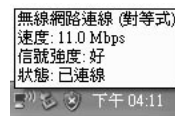

## Connecting to computer-to-computer networks (peer-to-peer or ad hoc)

In computer-to-computer wireless networks, you can wirelessly connect 2 or more computers that have wireless LAN modules.

Using this method, a computer that is not connected to the Internet can share the Internet by accessing another computer connected to the Internet.  
(See P. 4-18. 'Sharing Internet Access')

You can connect by completing the following steps:

- ▶ Step 1. Set up a computer-to-computer network on a computer.
- ▶ Step 2. Connect to the configured computer from other computers.

### ■ Step 1. Setting up a computer-to-computer network

1. Right-click on the **Wireless Network Connection** ( ) icon on the taskbar, and select **View Available Wireless Networks**.

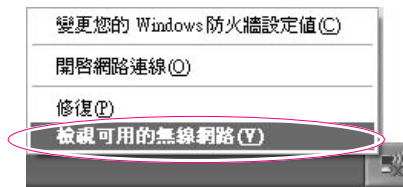

2. Click **Change the order of Preferred Networks**.

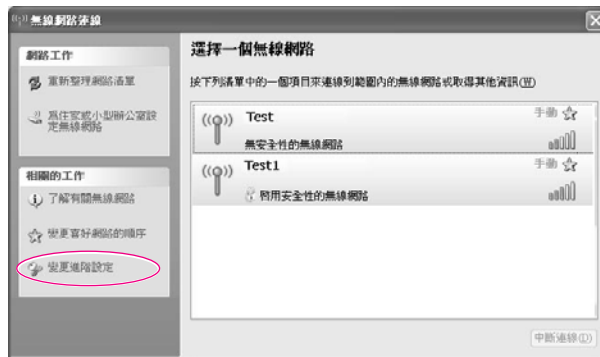

3. On the Wireless Networks tab, click **Advanced**.
4. Clear '**Automatically connect to non-default network**' check box, if it is selected.  
Select '**Computer-to-computer (ad hoc) networks only**', and click **Close**.
5. In the Wireless Networks tab, click **Add**.
6. Enter the network name (e.g. samsung), and unselect '**The key is provided for me automatically**'. Enter the encryption key in the Network key field, and click **OK**.



**Note** : To prevent a network connection from an unauthorized user, it would be better to configure a network key (encryption key). A network key consists of 5 ~ 13 alphanumeric characters (e.g. magic), or of 10 ~ 26 hexadecimal numbers (a hexadecimal number is represented by numbers '0' to '9' or letters 'a' to 'f').



7. Check that the configured network name (e.g. samsung) is in the 'Preferred networks item', and click **OK**.

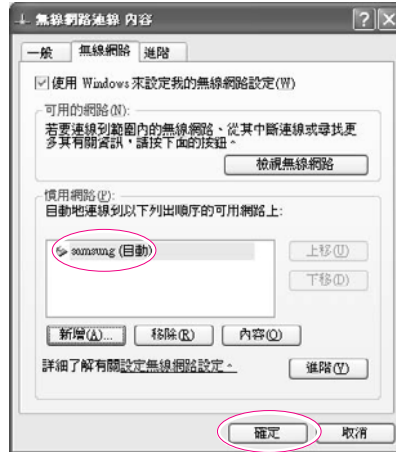

Now your wireless network setup has been completed.

## ■ Step 2. Connecting to the configured computer

1. Right-click on the **Wireless Network Connection** (  ) icon on the taskbar, and select **View Available Wireless Networks**.
2. Select the wireless network name (e.g. samsung) specified in “Connecting to computer-to-computer networks (peer-to-peer or ad hoc)”, and click **Connect**.



3. Enter a cryptographic key in the network key box and click Connect.

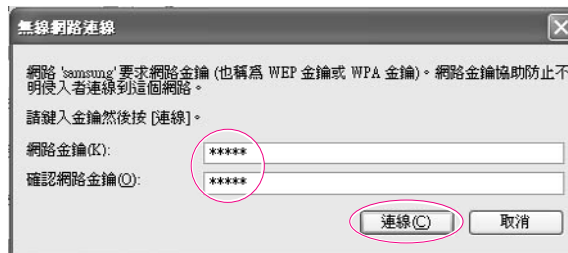

**Note** : If the network key is not configured in “Connecting to computer-to-computer networks (peer-to-peer or ad hoc)” on P. 4-10, just click **Connect**, without any key-strokes.

When connected to the wireless network, the system displays **Connected** in the selected network of the Network Connection window.

**Note** : **Checking the connection status.**

Move the mouse pointer over the **Wireless Network Connection** (  ) icon on the taskbar, and the connection status is displayed.



## Wireless Network Setup Using the Wireless LAN Setup Program

The procedures to connect to an access point using a wireless LAN configuration program are de-scribed below. Since the wireless LAN configuration program is included on the **System Software Media**, the user has to install the program.

1. Insert the **System Software Media** into the CD drive and install the wireless LAN configuration program (ACU: Atheros Client Utility).  
Select **System Software Media > User Installation > Wireless LAN Driver ReadMe**, click **ReadMe** and install the program according to the instructions.
2. Right-click on the **wireless LAN con-figuration program** (  ) on the taskbar and select **Open Atheros Client Utility**.  
Alternatively, click **Start > All Programs > Atheros Client Utility > Atheros Client Utility**.
3. In the Profile Management tab, click **Scan** to search for available wireless networks.
4. Select the name of an access point (AP) to connect to from the network name (SSID) and then click **Activate**.
5. Enter a profile name to be used for the connection and select the security settings of the AP to be connected to in the **Security** tab.

**Note** : The network authentication, encryption type and password of an access point are configured through the access point management program.  
: For the security information, check the security settings of an access point or ask your wireless network administrator.

: Refer to the following when setting a WEP key.

- **Data encryption (WEP):** The IEEE 802.11 WEP (Wired Equivalent Privacy) standard defines two levels of encryption, a 64-bit key (this is sometimes represented by 40bits) and a 128-bit key.

: When connecting to an Atheros access point, you can use the 152-bit key (32 hexadecimal digits or 16 ASCII characters).

- **Key index:** Select the current encryption key index used by the access point from between 1 to 4.

: **Using an encryption key:** Enter 5 (for 64-bit) or 13 (for 128-bit) alphanumeric characters (represented by 0-9, a-z, or A-Z).

6. Click **OK** and then **OK** again in the Profile Management window.  
If the profile is created, the profile appears in the list in the Profile Management tab and the connection is established using the profile.

## Using Samsung Network Manager

Samsung Network Manager is a program that has been developed to enable users to use the network easily.

Samsung Network Manager provides the following features.



- **You can easily set up the network and printer settings.**
- **You can immediately use the network without defining new network settings again after moving locations.**  
By setting the network settings (IP address, printer settings, etc.) for each location, you can immediately access the network without following network setting procedures each time regardless of your location.
- **You can easily share Internet Access.**  
You can share your Internet connection by setting up a computer with 2 LAN interfaces (wired and wireless, or 2 wired LAN) as the sharing server. Then, you can access the Internet on a sharing client by connecting to the sharing server.
- **You can diagnose the network status.**  
You can diagnose the network status when the network is not properly connected.

### ■ Using the Network

This section describes the procedures to connect to the Internet by setting up a network. The setting up procedures include the procedures to add a printer to the network.

**Note** : The setting up procedures are different for wired and wireless LAN connections. To use a wireless LAN, there should be a wireless LAN AP available nearby.

#### ► Setting Up a Network

1. To use a wired LAN, connect the **LAN cable** to the **LAN port**.  
To use a wireless LAN, press the <Fn> and < > key combination simultaneously to enable a wireless LAN.  
When the wireless LAN is turned on, the **Wireless LAN Operation LED** (  ) lights up.
2. Run **Samsung Network Manager**.  
Select **Start > All Programs > Samsung > Samsung Network Manager > Samsung Network Manager** or double click the **Samsung Network Manager** (  ) icon on the Desktop.
3. Click the **Add** button.
4. Select a network location icon and enter the name of the location (e.g. Home). Click the **Next** button.

5. Select **Internet direct connection** and click the **Next** button.



6. Select the LAN device, setup the IP address and click the **Next** button.

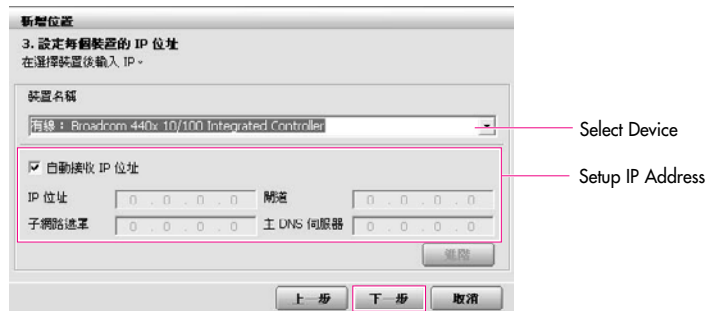

**Note** • **Select Device**

• Select a device to be connected to the Internet. Select either Wired LAN or Wireless LAN.

• **Setting up the IP Address**

• To allocate an IP address automatically (DHCP), select **Get IP Automatically**.  
 • To use a static IP address, unselect **Get IP Automatically** and enter an IP address. For IP address information, ask your network administrator.

7. When the Printer Setting window appears, click **Finish**.

To add a printer, click **Add Printer**. The Add Printer Wizard appears. Set up the printer according to the instructions displayed on the screen.

When the printer has been added, click the **Show printer** button, select the newly added printer and then click the **Finish** button.

**Note** • To not add a printer, select **No Default Printer** and then click the **Finish** button.

• When the network setting is complete, the 'Do you want to move to newly added location now?' message appears. If you select 'Yes', the network settings for the added location are applied.  
 • When the network settings for the added location are applied, the added place and the corresponding network connection information is displayed in **The detailed Information for window**.

When the network setting is complete, an icon for the added location is created within the Saved Locations window. Now you can use the Internet or add a new network location.

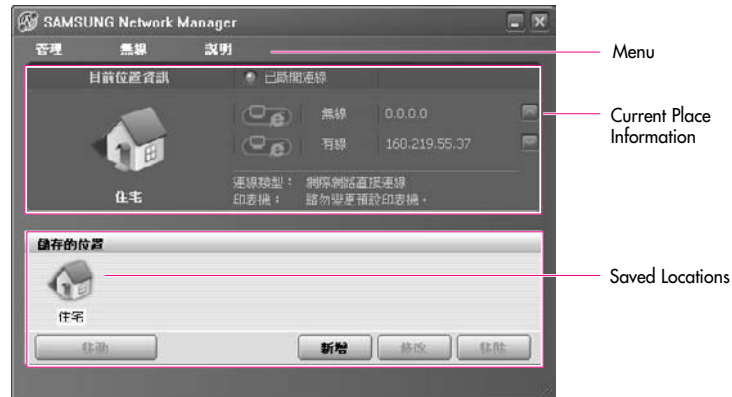

### Note Wireless LAN AP Connection Procedures

To use a wireless LAN, first connect to a wireless LAN AP and then you can access the network even when moving location. Or moving location and then you can access the network even when connecting to a wireless LAN AP.

1. Right-click over the **Wireless Network Connection** ( ) icon on the Taskbar and click **View Available Wireless Networks**.
2. Select an available wireless network (e.g. SAMSUNG) and click the **Connect** button. For information on available wireless LAN APs, ask your network administrator.



3. The network key (security key) input window appears.
  - If a network key has been set for the wireless LAN AP, enter the network key and click the **Connect** button. For the network key information, ask your network administrator.
  - If no network key has been set for the wireless LAN AP, click the **Connect** button without entering the network key.
4. When the computer is connected to the wireless LAN AP, the **Connected** message will appear on the Wireless Network icon in the Taskbar.

### ► Using the network after moving location

By setting the network settings (IP address, printer setting, etc.) for each location, you can immediately access the network without performing the network setting procedures regardless of your location.

1. Run Samsung Network Manager when connected to the Internet.
2. Select an icon that represents the corresponding location from the Saved Locations window and then click **Move**.
3. When the network settings of the selected location are applied, the new location and the network connection information are displayed in the **The detailed information for window**.



## ■ Sharing Internet Access

This section describes the procedures to share Internet Access.

To share Internet Access, you first have to define a sharing server and a sharing client. When the setup is complete, you can access the Internet from the sharing client by connecting to the sharing server.

- Note** : Sharing Server : A computer with 2 LAN interfaces that provide a function to share Internet Access.
- Sharing Client : A computer that uses the Internet by connecting to a sharing server without itself having a direct connection to the Internet.
- You can connect a sharing server and a sharing client as follows. (See Figure 5 on page 4-16.)

	Sharing Server		Sharing Client
	External Internet Device	Client Device	
Connection 1	Wired LAN	Wireless LAN	Connect a sharing client with the device that is the same as the client device of the sharing server.
Connection 2	Wireless LAN	Wired LAN	
Connection 3	Wired LAN	Wired LAN	

- For Connection 3, you have to connect a LAN card in advance.
- To connect a sharing server and a sharing client using a wired LAN, connect the computers with a crossover LAN cable or network hub first.
- To use a wireless LAN, press the <Fn> and < > key combination simultaneously to enable a wireless LAN.
- When the wireless LAN is turned on, the **Wireless LAN Operation LED** ( " " ) lights up.

As an example, Internet sharing procedures for **[Connection 1]**, which connect the sharing server and the Internet through a wired LAN and connect the sharing server and the sharing client through a wireless LAN, are described below.

## ► Setting Up a Sharing Server

1. Run **Samsung Network Manager** on the computer to be used as the sharing server.
2. Click the **Add** button.
3. Select a network location icon and enter the name of the location (e.g. Home). Click the **Next** button.
4. Select **Internet direct Connection for sharing** and click the **Next** button.
5. Set up the network device to be connected to the external Internet. Determine whether to use a firewall and select a network device to be connected to the external Internet (e.g. Wired LAN). Set the IP address and then click the **Next** button.

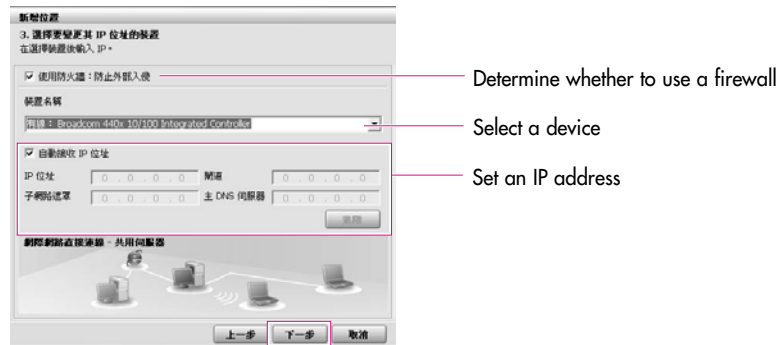

- Note** :
- To protect against external intrusion attempts, using a firewall is recommended.
  - For more information on selecting a device and setting the IP address, refer to the description of item 6 of Setting Up a Network on page 4-16.

6. Select a network device to connect to the sharing client (e.g. wireless LAN) and click the **Next** button.

## **Note** : To Share Internet Access through a Wireless LAN

- In the Select Device field, **select Wireless**.
- In the **Wireless Connection Name** (e.g. Samsung) field, enter the network name.
- To use the network key (security key), select the **'Use Network Key,,,'** option and enter a network key. Remember the network key because you have to re-enter the key on the sharing client to connect to the sharing server.

7. The setup information is displayed. Confirm the settings and click the **Next** button.
8. When the Printer Setting window appears, click **Finish**.  
For the printer setup procedures, refer to **Setting Up a Network** on page 4-15.

When the Shared Server setting is completed, set up the shared client.



### ► Setting Up the Sharing Client

1. Run **Samsung Network Manager** on the computer to be used as a sharing client.
2. Click the **Add** button.
3. Select a network location icon and enter the name of the location. Click the **Next** button.
4. Select **Internet Sharing** and click the **Next** button.

**Note** : · To connect through a wireless LAN, select **Internet Sharing - Wireless**.  
· To connect through a wired LAN, select **Internet Sharing - Wired**.

5. Confirm the network device to be connected to the server and click the **Next** button.

**Note** : · To connect through a wireless LAN, enter the **wireless connection name** (e.g. Samsung) you entered in the sharing server. If you have set a network key (security key) for the sharing server, enter the network key.

6. The setup information appears. Confirm the information and click the **Next** button.
7. When the Printer Setting window appears, click **Finish**.  
For the printer setup procedures, refer to **Setting Up a Network** on page 4-15.

When the settings are completed, you can use the Internet on the shared client.

**Note** : · To access the Internet from the sharing client, the sharing server has to be on.  
· To use the Internet on the sharing client, select a sharing client icon from the **Location List** window and then click the **Move** button.  
· If the connection is broken while using the Internet on the sharing client, click the **Ap Active** from the **Wireless** menu to reestablish the connection.

## ■ Network Status Diagnosis

You can diagnose the network status when the network is not properly connected.

1. Run **Samsung Network Manager**.
2. Select **Diagnose Status** from the **Manage** menu.
3. The Network Connections figure window appears. Click the **Start** button to start the network diagnosis.
4. When the diagnosis is complete, out of order devices are marked by the exclamation mark icon. For detailed device status, read the description in the lower part of the window.



## Using Network Services

While the computer is connected to the network, you can use network services to share files, folders, and printers.

**Note** : Network services are provided for the computers that are connected to the network through wired or wireless network connections. (See Pages 4-4, 4-7, **Configuring Network Environment Settings**)

### Sharing files or folders

This section describes how to share files and folders between computers connected to the network.

To share files, complete the following procedures:

- ▶ Step 1. Configuring the sharing of files and folders on a computer.
- ▶ Step 2. Accessing shared files and folders from another computer.

**Caution** : When a file or folder is shared, anyone connected to the network can open and delete the shared file or folder.  
: Configure a file sharing network only when the network is secure, and do not share important data.

## ■ Step 1. Configuring Sharing

1. Right-click the target file or folder to share in **My Computer**, and select **Sharing and Security**.

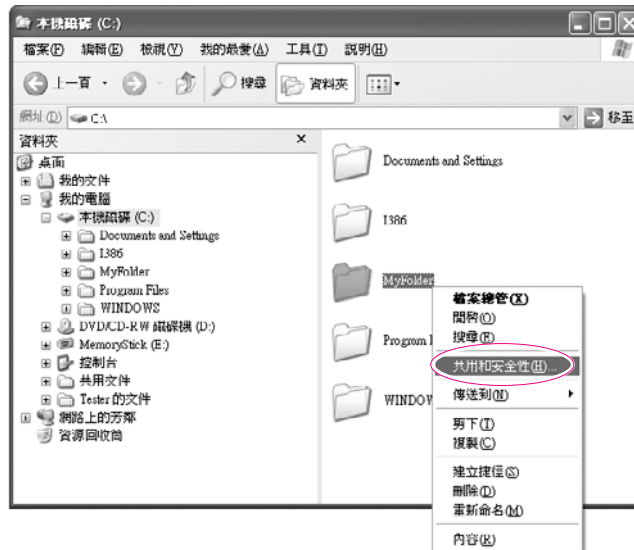

2. Click '**IF you understand the security risks but want to share files without running the wizard, click here**'.

**Note** : It has the same security effect as that of the '**Network Setup Wizard**'.  
: This screen does not appear if Internet Sharing Network Wizard has been  
: installed in the computer-to-computer wireless network environment.

3. Select '**Just enable file sharing**', and click **OK**.
4. In the 'Network sharing and security' field, select '**Share this folder on the network**', enter the share name, and click **OK**.

**Caution** : Be cautious when selecting 'Allow network users to change my files' since other network users can change the files in the shared folder.

The file and folder sharing configuration has been completed.

## ■ Step 2. Using Shared Files or Folders

This section describes how to access shared files or folders if your computer is a member of the same workgroup.

1. Click **Start > My Computer**. Under **Other Places**, click **My Network Places** in your computer.
2. Click **'View workgroup computers'**, and click the desired computer to access the shared file.



- Note** :
- 1. Click **Other Places > Microsoft Windows Network**.
  - 2. Click the desired workgroup.
  - 3. Click the desired computer to display the shared files or folders.

## Sharing Printers

This section describes how to share a printer between computers connected to a network.

To share a printer, complete the following procedures:

- ▶ Step 1. Configure printer sharing in the computer connected to the printer.
- ▶ Step 2. Add and use the shared printer in other computers on the network.

### ■ Step 1. Configuring Printer Sharing

1. From the computer connected to the printer, click **Start > Printers and Faxes**.
2. Right-click the printer you want to share, and click **Sharing**.



3. Select **'Share this printer'**, enter a share name for the shared printer, and click **OK**.

4. In the Printers and Faxes window, you will find the printer icon has been changed to another icon on a hand.



## ■ Step 2. Adding and Using a Shared Printer

1. From a different computer that wants to use the shared printer, click **Start > Printers and Faxes**.
2. Click **Add a printer**.
3. In the **Add Printer Wizard**, click **Next**.
4. Select '**A network printer, or a printer attached to another computer**', and click **Next**.
5. Select '**Browse for a printer**', and click **Next**.
6. Select the workgroup or computer, select the desired printer, and click **Next**.



If you cannot find the desired printer, try again after a while.

7. Read the warning about a shared printer, and click **Yes** to install the shared printer.
8. Select **Yes** for 'Do you want to use this printer as a default printer?', and click **Next**.
9. Click **Finish**.
10. When the printer sharing configuration has been completed, the shared printer appears in the Printers and Faxes window.



Now you can print using the shared printer even if your computer is not directly connected to a printer.



## Using Bluetooth Devices (Optional)

Bluetooth is a wireless communication technology that allows access to devices nearby such as a computer, mobile phone, printer, keyboard or mouse without a cable connection. Bluetooth enables file transmissions, Internet access, a private area network function, and access to a keyboard, mouse and printer between devices supporting the Bluetooth function without a cable connection.

- Note** :
- The Bluetooth function is only available between devices supporting Bluetooth (computers, mobile phones, PDAs, printers, etc.), and the function may be restricted depending on the device profile.
  - The Bluetooth function is optional and may not be supported depending on your model.
  - Compatibility with a Bluetooth device not certified by a Bluetooth certification or logo is not guaranteed.

### ■ Bluetooth Functions

- **File Transmission** (📁)   
You can exchange files between 2 Bluetooth devices. You can exchange files with other computers, mobile phones, PDAs, etc.
- **Network Access** (🌐)   
You can connect to another computer with the Bluetooth function as you access a wireless LAN in Ad-Hoc mode or connect to the Internet through an AP or Internet Connecting Sharing Server.
- **Network Access through a Phone Connection** (📞)   
You can connect to the Internet through a Bluetooth mobile phone.
- **Data Sync (Synchronization)** (🔄)   
You can synchronize the PIMS data (Outlook E-mail address data) with mobile phones, PDAs, notebook computers, etc. supporting Bluetooth.
- **Electronic Business Card (Vcard) Exchange** (📇)   
You can exchange electronic business cards with mobile phones, PDAs, notebook computers, etc. supporting Bluetooth.
- **Sound Output** (🔊)   
You can listen to audio from the computer through another Bluetooth device or listen to audio of another Bluetooth device through the computer.
- **HID Connections** (🖱️)   
You can connect a keyboard, mouse, joystick, etc. supporting Bluetooth.

**Note** : For more information about using the Bluetooth function, refer to the online help of the Bluetooth Device.

## Bluetooth Software Setup

Bluetooth software is installed on computers supporting Bluetooth. For first time use, set up the Bluetooth software as follows.

1. Double-click My Bluetooth icon(  ) on the desktop.
2. Click the **Next** button to start setting up.

**Note** : In the setting up steps, enter a device name to be displayed in the Bluetooth Manager program. Enter a **Name** in the Computer Name field and select **Laptop** for the Computer Type field.

Also, a step appears for selecting the services to be provided by your Bluetooth device for other Bluetooth devices. At this point, the program automatically detects available services and displays them as selected. It is recommended not to change the default selection.

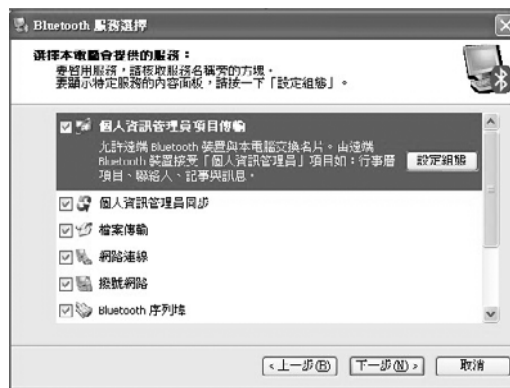

If you change the service settings, the driver necessary for the additionally selected services are installed.

At this point, a warning message may appear informing you that there is no Microsoft logo. Since it does not affect the operation, continue the installation.

3. If the driver installation is complete, the next step proceeds which searches for nearby Bluetooth devices. Since you do not have to search while setting up, click the **Skip** button and finish the settings.



4. When the settings are complete, the **Bluetooth** icon menu of the notification area changes as shown in the figure.

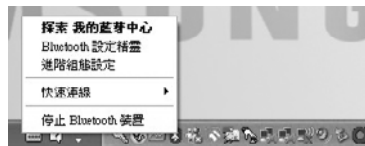

## Using Bluetooth

Describes how to exchange files between computers supporting Bluetooth and how to use other Bluetooth devices.

### ■ Bluetooth Help

Bluetooth Help provides detailed procedures on using Bluetooth functions.

Click on **My Bluetooth Settings** on the **Desktop** and press the **F1 key** (Help).



**Note** : Select Start > Help and Support > Networking and the Web > Networking > Wireless networking > Bluetooth devices (wireless) to view Windows Help.

## ■ Exchanging Files between Bluetooth computers

The procedures to exchange files and folders between Bluetooth computers are described below.

1. On the computer that is sending a file (hereafter Computer A), right-click the **Bluetooth** icon (📶) in the notification area and select **Quick Connection > File Transmission > Search for Device**.

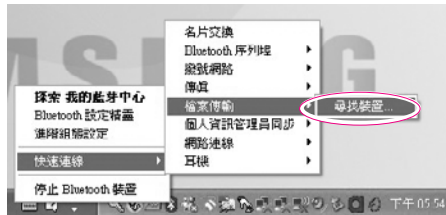

2. In the Select Device window, click on a computer to be connected (hereafter Computer B).

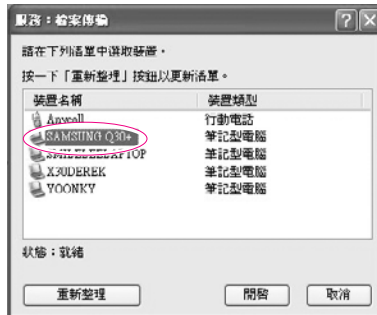

3. If the **Bluetooth PIN code requested** notification window appears on the bottom right taskbar, click on the window, enter the **Bluetooth PIN code** and click the **OK** button.

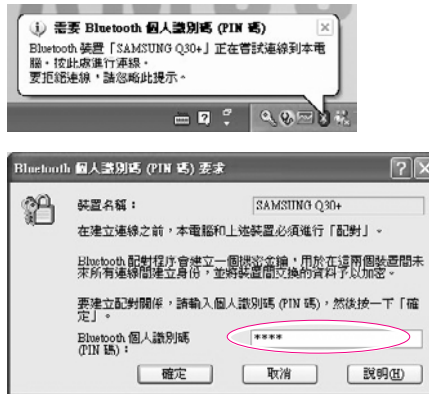

**Note** : The **Bluetooth PIN Code** is a password used for the connection between two Bluetooth devices, the user just enter the same PIN Code (E.g. same numbers) on both Bluetooth devices to make a connection.

4. After a short while, the **Bluetooth PIN Code required** dialog box appears on Computer B, enter the code that you have entered in Step 3 above.
5. If the Bluetooth PIN code requested notification window appears on the bottom right taskbar, click on the window, enter the **Bluetooth PIN code** and click the **OK** button.
6. The file transmission window appears on computer A. Drag files or folders to send onto the window, and the files or folders are automatically transmitted.

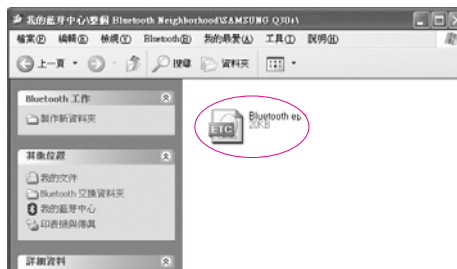

7. If the file transmission is complete, close the File Transmission window.  
The received files are saved in the C:\Documents and Settings\[user name]\My Documents\Bluetooth Exchange folder.

## ■ Connecting Keyboard, Mouse, Joystick and Headset devices

The procedures to use Bluetooth HID devices (keyboard, mouse, joystick, etc.) or a headset, etc. on the computer are described below.

**Note** : The Bluetooth PIN Code is a password used for the connection between two Bluetooth devices, the user just enter the same PIN Code on both Bluetooth devices to make a connection.

1. Turn on the Bluetooth function on the device to connect to (mouse, keyboard, joystick or headset).  
Some devices have a button to turn on the Bluetooth function, so refer to the corresponding device manual.

2. Double-click on the **My Bluetooth Settings** icon (  ) on the Desktop.

3. If the **My Bluetooth Settings** window appears, click on **View Devices within Coverage**.  
If the device to connect to appears, click on the device. (E.g. mouse)



**Note** : If the device does not appear, click the **View Devices within Coverage**. If the device has not appeared yet, since this menu changes to **Search Devices within Coverage**, click the **Search Devices within Coverage** to show the device.

4. If the **Bluetooth PIN Code** input window appears, enter a PIN code referring to the manual of the corresponding device. The PIN code for an HID device is generally printed in the manual of the corresponding device.

5. If you enter the PIN code, you can immediately use the device.

**Note** : A Bluetooth keyboard and mouse work only in Windows. They will not work in MS-DOS mode or in Hibernation mode.

## ■ Stopping a Bluetooth device

Right-click the **Bluetooth** icon (  ) on the taskbar and select **Stop the Bluetooth device**.



To use a Bluetooth device after stopping it, select **Start Bluetooth device** as above.

## ■ Use Instructions

- Bluetooth devices must be within a 3m distance.
- For a better communications environment, use the devices in an open space where no wall or obstacle exists.
- For a telephone connection, data synchronization, electronics business card exchange, fax transmission/reception, sound related functions, and serial port function, you can connect with only one Bluetooth device.
- Using the network connection or file transmission function, multiple Bluetooth devices can be connected. However, since connecting with multiple devices may slow down the data rate or make the connection unstable, connecting with one device at a time is recommended.
- The Bluetooth function of a Bluetooth PDA, mobile phone, mouse or keyboard may be turned off. To use them in connection with a Samsung computer supporting Bluetooth, you must check if the Bluetooth function of the device to connect to is turned on.

For the procedures on turning on the Bluetooth function of a device, refer to the manual of the device.

- The services provided by Bluetooth devices may vary depending on their capability. For the services provided by Bluetooth devices, refer to the manual of the device.





# Chapter 5

## **System Management**

This chapter provides information on efficient computer management.

## Managing Power

Use Power Options to save power consumption. You can switch Standby Mode while you are not using your computer or configure the system components to shut it down on a specified time.

### Specifying Power Save Time

You can specify Turn Off Monitor, Turn Off Hard Disk, System Standby Mode, and Maximum Power Save Mode.

Select **Start > Control Panel > Performance and Maintenance > Power Options > Power** Schemes tab. Then specify time in each item and click OK.

**Note** : The Power Setting is set to BatteryMgr-Normal Mode. BatteryMgr-Normal Mode extends the battery use time when using battery power, and optimizes the Intel Speedstep feature. Since it automatically optimizes the processing speed of the system to minimize power consumption, you may experience slower operations when using battery power than when using AC power. To use BatteryMgr-Normal mode in the Windows system, please install the Battery Manager program by using the System Software Media.

#### Monitor Off

The LCD display goes into Power-Saving mode after the specified period of time.

#### Hard Disk Off

The Hard Disk goes into Power-Saving mode after the specified period of time.

#### Standby Mode

If the computer is not used for the specified period of time, the monitor and hard disk drives are turned off to reduce power consumption.



#### Hibernation Mode

Saves the current working status onto the hard disk and turns the computer off. Pressing the Power button restores the computer to the previous working status.

**Note** : Press Power button to use computer again in Standby Mode or Hibernation Mode.  
You can also reserve Turning Computer Off, Maximum Power Saving Mode, Hold Mode, etc. by selecting System > Computer Scheduling in the EasyBox program. (See P. 3-10.)  
If you change the power settings in the Battery Manager program, the settings of the 'Power Options Properties' window are automatically changed accordingly (see P. 5-6).

## Using the Power button

You can configure the function of the power button.

Click **Start > Control Panel > Performance and Maintenance > Power Options** and select the Advanced tab.

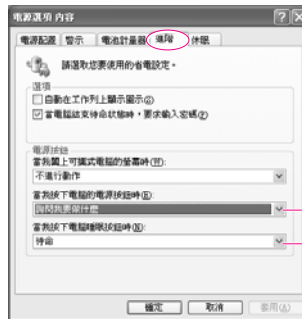

Configure the Power button function.

Configuring the function of the <fn>+<Esc> key combination.

**Caution** : When the Power button is configured to put the system into Power-Saving Mode, manually shutting down the computer requires the Power button to be pressed and held for more than 4 seconds.

## Using the Battery

Please refer to the following instructions when running the computer on battery power without connecting the AC power. This computer uses smart rechargeable Lithium-Ion (Li-Ion) battery.

### Caution

#### Precautions

- Use only chargers specified in the User Manual.
  - Never heat the battery pack, put it near or in a fire or use at a temperature higher than 60°C, as this may cause fire.
  - Never cause a short circuit between the battery pack terminals or disassemble the battery pack.
  - Carefully read and follow the precautions printed on the battery and the safety instructions in the User Manual before using the battery.
- 
- Please read the instructions on the battery before use.
  - Please refer to the system operation environment (Page A-2) of this manual and operate and store the battery at room temperature.

## Ejecting and Attaching Battery

1. Shutdown system and close LCD.
2. Put the computer upside down.
3. Pull the two battery latches outward( ⇐ ⇨ ), then remove the battery.

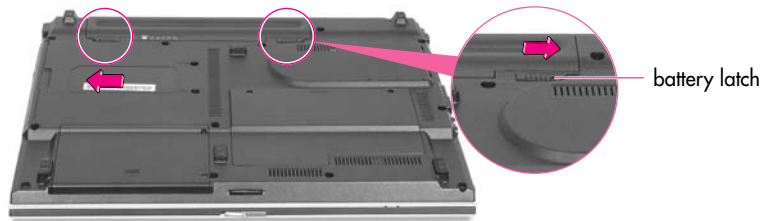

4. To install the battery again, slide the battery into the system as below. The battery latch moves inward, and fixes the battery automatically.

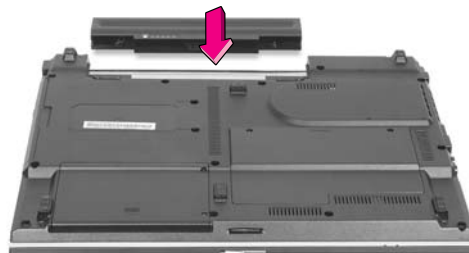

## Monitoring the Battery Charge

You can view the battery charge status by completing the following procedures.

### ■ Using the shortcut key to view

If you press the <Fn>+< > key combination on the keyboard, the remaining battery charge appears on the screen for a while. It appears only when the Samsung Display Manager program is installed on your computer.

### ■ To view on the battery

Press the PUSH button on the battery. The remaining battery charge (%) will be displayed.



PUSH button

### ■ To view through the Control Panel

Select Start > Control Panel > Performance and Maintenance > Power Option > Power Measure tab.

Then you can view the current power source and the current remaining battery charge.



Power supply status

Remaining Battery Charge

#### Caution : Using the battery

- Battery is an expendable supply, so when you use it for a long time, the capacity/battery life is shortened. If the battery life time is reduced to under half of the initial time, we recommend that you purchase a new battery to use.

#### Note : Battery Warning

- You will hear an alarm when the remaining battery charge is under 10%. Connect the power cable or turn off the computer and install a fully charged battery.
- When the remaining battery charge is under 3%, the computer automatically saves current work and turns off. This may be different according to the settings in **Control Panel > Performance and Maintenance > Power Options > Alarms** tab.

## Extending the battery use time

### ■ Decreasing the LCD Brightness

Decreasing the LCD brightness by pressing the <Fn>+< > key combination on the keyboard or adjusting the brightness in the Battery Manager program extends the battery use time.

Decreasing the LCD brightness by one level extends the battery use time by 3~5% (10~20 minutes). (The battery use time is determined by the corresponding model.)

### ■ Using the Battery Manager

Battery Manager is a power management program that enables using battery power efficiently.

You can easily change the power mode by selecting an optimized power mode and manually optimizing the battery use time by setting each option.

Click on **Start > All Programs > Samsung > Samsung Battery Manager > Samsung Battery Manager**.



Change Power Mode

Power Saving Effects

You can only change the detailed configuration in **Custom Mode**.

- ▶ **Maximum Battery Saving Mode** : This mode is appropriate for conditions which require the maximum battery use time. This may degrade the performance of the system.
- ▶ **Normal Mode** : This mode is appropriate for normal conditions. Both system performance and battery use time are optimized.
- ▶ **Maximum Performance Mode** : This mode is appropriate for conditions that require maximum system performance. Therefore, the battery usage time may be reduced in this mode.
- ▶ **Custom Mode** : In this mode, a user can configure a detailed configuration to save the battery usage time. You can adjust the LCD brightness, the system standby time, the screen color quality, and the graphic mode values.

**Note** : **Power Saving Effect**

This shows the relative battery use time for each power mode. The more effective the power saving, the longer the graph will appear.

**When Running a Game or Multimedia Application**

A game or multimedia application may not work smoothly in Maximum Battery Saving Mode. Using this is recommended when the AC adapter is connected or in Normal or higher modes.

## ■ Turning Off Unnecessary Devices Turning off

Turning off unnecessary devices extends the battery use time.

Select the **Start > Control Panel > Performance and Maintenance > System > Hardware** tab and click **Device Manager**. Right-click a device you are not using, and select 'Disable' (e.g. Wireless LAN, IEEE 1394 etc.)

## ■ Use Battery Calibration

If you charge/discharge the battery repeatedly for only a short time, the battery use time may be reduced by the difference between the actual battery charge and the remaining charge display. In this case, the actual battery charge and the remaining charge display will be same by discharging the battery completely using the Battery Calibration function, and then recharging it again.

1. Turn off the computer and disconnect the AC power.
2. Turn on the computer and press <F2> to enter into System Setup.
3. Select **Smart Battery Calibration** in the **Boot** Menu, and press <Enter> to start.

The Battery Calibration function is activated and the battery is discharged forcibly. This operation requires 3~5 hours depending on the battery capacity and the remaining battery charge.

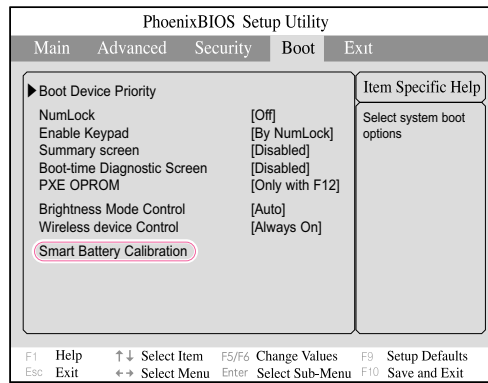

4. When the calibration process is complete and the battery is completely discharged, connect the AC power adaptor to fully recharge the battery.



## Upgrading Memory

This computer has one or more 512MB memory module(s). Two memory module sockets are provided so that you can replace memory or install an additional memory module.

- Note** :
- Before replacing the memory module, turn the system off completely and remove the battery. Do not replace the memory module when the system is in Rest Mode.
  - When using memory in dual channel, using memory of the same specification (the same capacity and manufacturer) is recommended.

1. Using a screwdriver, open the memory-module compartment cover on the bottom of the system.

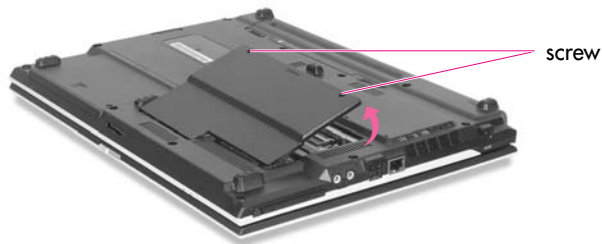

2. Push the memory module tabs outward to pop the memory module outward. Pull the module out at an angle of about 30°.

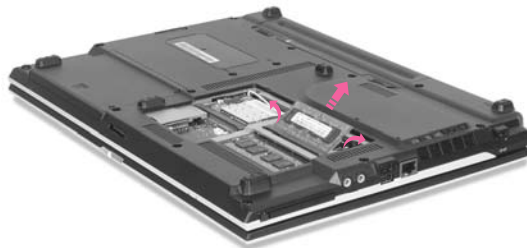

3. Align the new memory module connectors accordingly and slide it into the slot at a 30° angle.

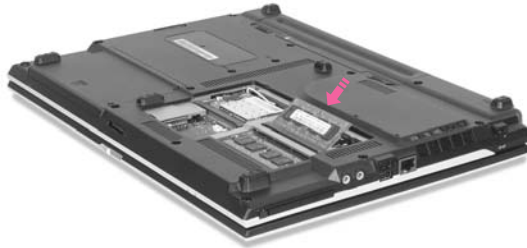

4. Push the memory module in until the module clicks into place. If the memory module is not fixed completely, push the module while pressing the memory module tabs outward.

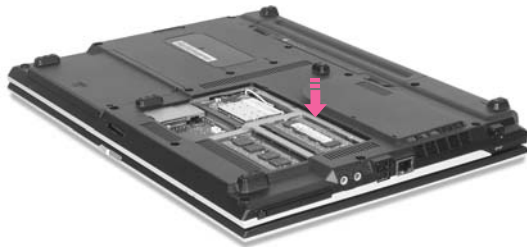

5. Close and fix the memory-module compartment cover using a screwdriver.

## Using the Security Lock

The security lock is a device used to physically 'fix' the system when using it in a public place. The locking device needs to be purchased separately. The shape and methods of use may differ depending on the manufacturer. Please refer to the manual provided with the security lock for proper use.

Fix the Kensington lock cable to a fixed object (①) and connect the cable to the Anti-theft port at the rear of the system (②).



## **Traveling with the Computer**

- When traveling, keep the system and the AC adapter disconnected. Otherwise, it may affect the functions of the system.
- Make sure that the system is not pressed by a book or heavy objects. The LCD may get damaged.
- When traveling by plane, use a bag designed for notebook PCs and hand-carry the computer.
- Allow the computer and disks to pass through security X-rays but do not pass the computer and disks through metal detectors.
- Do not use the computer during take off and landing.
- Make sure the eject button of PCMCIA card slot is locked.
- Please follow the instruction of the corresponding facilities regarding the use of wireless devices (wireless LAN, Bluetooth , etc.) when in a wireless communication restricted area (e.g. airplane, hospital , etc.).



# Chapter 6

## **Customizing your computer**

This chapter provides information  
how to use the system setup,  
customizing screen settings.

# Using System Setup

System Setup is a utility that enables the computer environment to be changed to suit the user. System Setup is used when changing the system password, booting priority, or when adding new devices. Please use extra care when configuring System Setup, as it may cause serious system error.

## To enter System Setup

1. Turn on the computer.
2. When the booting screen appears, press <F2>.



3. The initial System Setup screen will appear in a moment.

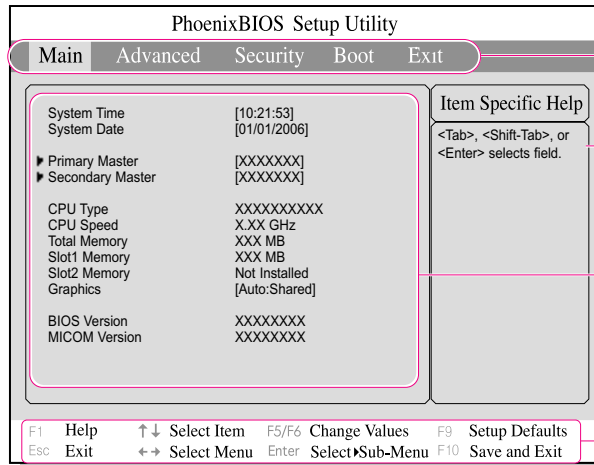

Setup Menu

Help

Displays help information on the current selected item.

Setup Item

Navigation Keys

Use these navigation keys to view and change the System Setup settings.

## System Setup Menus

Menu Items	Description
Main	Configures the basic system environment
Advanced	Configures OS and major chipset options of the system
Security	Configures system security options
Boot	Configures booting options
Exit	Exits System Setup

**Note** : For more information on System Setup menus or options, please refer to Help on the right side of the screen.

## System Setup Navigation Keys

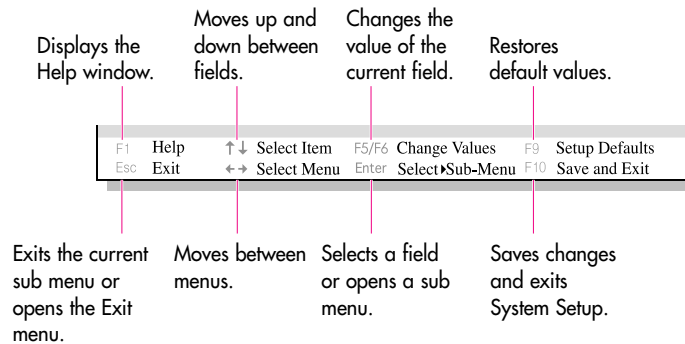

**Note** : Contents of System Setup may be changed due to functional improvement or other reasons.



# Configuring the Password

## Setting the Supervisor Password

By configuring a supervisor password, you can restrict system access to authorized users only.

**Note** : Do not lose or forget your password. If you have forgotten your password, contact the Samsung service center.

1. Select the **Security** menu in the System Setup. (To enter into System Setup, see Page 6-2.)
2. On the '**Set Supervisor Password**' item, press <Enter>.

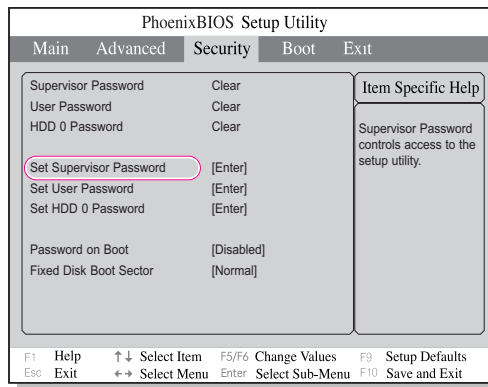

3. Enter a password, press <Enter>, re-enter the password for confirmation, and press <Enter> again.

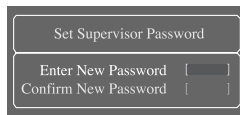

4. When a message confirming the password configuration appears in the [Setup Notice] window, press <Enter>.

## ■ Setting the User Password

You can configure user passwords so that other users can use the system.

- Note** :
- Before configuring a user password, a supervisor password must have been configured.
  - Users can start the system with their user password, but cannot enter into the System Setup.
  - Deactivating the supervisor password also deactivates the user password.

On the 'Set User Password' item, press <Enter>, and complete step 3-4 of Configuring the Supervisor Password.

## ■ Activating the Booting Password

- Note** :
- Before activating the booting password, the supervisor password must have been configured.

Set the 'Password on boot' option to [Enabled].

From now on, you must enter the password to boot the system.

## ■ Setting up a Hard Disk Drive Password

A supervisor password must be set using the Set Supervisor Password menu. If you set a password for a hard disk drive, it cannot be accessed from another computer.

Press Enter in the 'Set HDD 0 Password' item and define a password as described in Step 3 of the Setting up the Supervisor Password.

## ■ Deactivating the Password

1. On the password to delete, press <Enter>. (e.g. supervisor password)
2. Enter the current configured password, and press <Enter>.
3. Leave the 'New Password' and 'Confirm New Password' field empty, and press <Enter> to deactivate the password.

## Changing Booting Priority

You can select the booting priority among the devices such as the hard drive, CD-ROM drive, etc. The following example describes how to configure the hard drive as the first booting device when the CD-ROM drive is configured as the first booting device by default.

1. Select the Boot Menu in System Setup.
2. Press <Enter> on **Boot Device Priority** item.

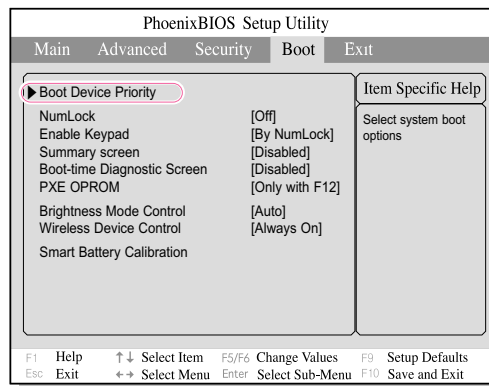

3. Use the <↓> key to move to the **Hard Drive** item, and press <F6> key until it is at the very top.

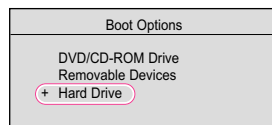

4. Press <F10> to save the changed configuration, and exit System Setup.  
Now you can boot the system with the hard disk drive as the first booting device.

## Configuring Resolution and Color Depth

Screen resolution is the number of pixels displayed on the screen. High resolution makes the overall screen area large, although individual items appear small. Color quality is determined by the number of bits used to represent a pixel on the screen. High color quality displays more number of colors on your screen.

1. Select **Start > Control Panel > Appearance and Themes > Change the screen resolution**.
2. Make changes on the **Settings** tab of the [Display Properties] dialog.

You can view the graphics chipset.



To change the number of colors displayed on a monitor, select an appropriate color quality.

To change your screen resolution, move the slider to select an appropriate resolution.

3. When you have completed configuration, click **Apply**.

**Note** : The following resolution and color quality settings are recommended depending on the LCD screen of the system.

• **WXGA**: Screen resolution: 1280 x 800, Color quality: Very high (32bit)

## Using External Display Devices

Using external display devices such as a monitor, projector, TV, etc allows you to view screen images alternatively or simultaneously on each device. Additionally, you can extend the screen onto two display devices to use a larger workspace. Using external display devices is especially useful when you are giving a presentation or watching a movie through your TV.

### Switching Display Devices Using the Shortcut Key

You can watch the screen through either the LCD or an external display device, or you can even watch the screen through both the LCD and an external display device simultaneously.

1. Connect the external display device (e.g. a monitor or a projector) to the corresponding port of the system.  
To connect a TV, connect the TV to the TV output port of the system.

#### Note : Connecting to a TV

- To connect to a TV, connect the TV-Out port of the system and the S-Video port of the TV with the S-Video cable. (The cable is not included and needs to be purchased additionally.)

2. If you press the <Fn> + <> key combination once, the **Samsung Display Manager** screen appears where you can select a screen. Whenever you press the <F4> key while pressing the <Fn> key, selection moves to the next item. Select a mode.



Example) Select LCD+CRT

- #### Note :
- LCD:** Notebook Screen
  - CRT:** External Monitor Screen
  - LCD+CRT:** Notebook + External Monitor Screen
  - TV:** TV Screen (connected to the TV OUT port)
  - LCD+TV:** Notebook + TV Screen (connected to the TV-Out port)

- In the MS-DOS environment, the picture is displayed to the LCD > CRT, in turns, and output to a TV/DVI is not supported. In full screen MS-DOS mode of Windows, you cannot change the display device by pressing the shortcut key.

## ■ Using Dual View to View an Extended Screen

Dual View is a function that enables you to view a computer screen over two display devices. This is convenient when needing a wide screen for work.

In Dual View mode, you can select the screen resolution and colour quality for each display device, as if there were two separate graphics cards.

1. Connect the external display device (e.g. a monitor or a projector) to the corresponding port of the system.  
To connect a TV, connect the TV to the TV output port of the system.  
(‘See P. 6-8 Connecting to a TV’)
2. Press touchpad right button on the desktop, click **Properties**, and then click the **Settings** tab.
3. Click the **monitor ‘2’** icon, select the **‘Extend my Windows desktop onto this monitor’** check box, and then click **Apply**.



4. When you have completed this, click **OK** on the left of the Troubleshoot button. The primary display device (the LCD) is indicated as ‘1’, and the secondary display device is indicated as ‘2’. Now you can use each of the two display devices as independent display devices. <Enter> to deactivate the password.



1: Primary



2: Secondary

**Note** : When you use Dual View, configuring the LCD as the **'Primary'** monitor is recommended.

**Caution** : If the screen of the secondary display device is displayed at 640x480 pixels, with 256 colors, change the settings to the desired screen resolution and color quality in the **[Display Properties]** window.

**Note** : When Dual view is not properly set up, refer to Q&A.

## ■ Deactivating Dual View Mode

Click the **monitor '2'** icon, clear the **'Extend my Windows desktop onto this monitor'** check box, and then click **Apply**.

**Note** : **To move a window between display devices in Dual View mode**  
: Click the title bar of the window in the primary display device (1, the LCD), and  
: drag it to the secondary display device (2). The window moves to the secondary  
: display device.

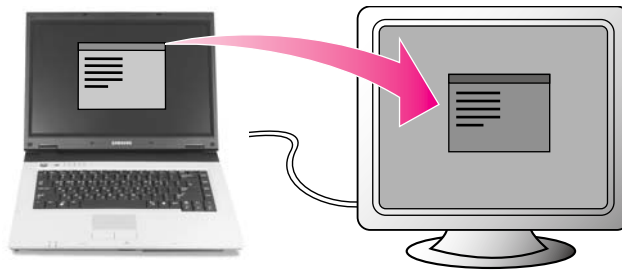

## Checking for Viruses

The Norton AntiVirus software is provided as the virus inspection program.

- Note** • When you first run Norton AntiVirus, the Norton AntiVirus Configuration window pops up. If you complete the configuration and your computer connect to network, you can download and install the latest updates via the network. When the live update is done, virus scanning starts automatically. To stop scanning, click on Stop.
- If you didn't configure the Norton AntiVirus program, a security alert icon (  ) appears in the notification area on the right of the task bar. This indicates that the current security state of your computer is not secure. Configure the virus-scanning program to make the security alert icon disappear.

1. Select **Start > All Programs > Norton AntiVirus > Norton AntiVirus 200x**.
2. Click **Scan Virus**, select drive to inspect, and click **Scan**.



Vaccines for the latest viruses can be downloaded by connecting to Symantec's homepage.

3. If a virus is detected, select Automatic in Norton AntiVirus, and click **Next** to delete the virus.





# Chapter 7

## Recovering the Computer

This chapter provides recovery procedures using the System Recovery CD when the computer is not operating properly.

## Using Magic Doctor

Magic Doctor is troubleshooting software provided by Samsung Computer. A user can diagnose system problems via one-click or by selecting diagnostic items.

1. Click **Start > All Programs > Samsung > Magic Doctor > Magic Doctor**.
2. Click on an icon at the top of the screen.



- **OneClick Diagnosis:** You can diagnose problems affecting the system connections and system operations via one-click.
  - **User Diagnosis :** You can select the necessary diagnostic items and diagnose system problems.
  - **System Recovery :** Launches the Restoring the System function of Windows XP. (P. 7-3)
3. When the system diagnosis is completed, the diagnostic result appears.  
If problems are found, click the **Cure** button to correct the problem. Magic Doctor starts the correction operations.

# Restoring the System

**Note** : This description is only for models running Windows XP.

The System Restore function allows you to restore your computer to an earlier copy (called restore point), and restores the settings if a problem occurs.

The System Restore function is provided by Windows XP to enable the resolution of various problems without reinstalling Windows XP completely.

You can use System Restore in the following cases.

- The system files are deleted or damaged by mistake.
- The system is unstable or a problem occurs in a device driver.
- A problem occurs after changing system files such as the registry.
- A problem occurs after installing a new program.

## Creating a Restore Point

Restore points are created at predetermined times and at times of significant system events such as when a program or a driver is installed. You can also decide when to create your own restore points.

**Note** : There has to be more than 200MB of free space on the hard disk drive. If the disk space is insufficient, a saved restore point might be deleted.

- You are recommended to create a restore point when you have purchased a new computer and before installing new programs or device drivers. Before creating a restore point, check that the computer is operating properly.

The procedures to create your own restore point are described below.

1. Click **Start > All Programs > Accessories > System Tools > System Restore**.
2. Select 'Create a restore point', and then click **Next**.



3. In the **Restore point description** box, type a name to identify the restore point, and then click **Create**. A restore point has been created.

## ■ Returning your computer to an earlier restore point

The procedures to return your computer to an earlier restore point when a problem has occurred are described below.

1. **Start > All Programs > Accessories > System Tools > System Restore.**
2. Select 'Restore my computer to an earlier time', and click **Next**.

**Caution** : Since changes made after the Recovery Point may not be maintained, please back-up all necessary files to another location before performing system recovery.



3. Select the desired restore date (①) from the calendar restoration and select the desired restore point from the list (②), and then click **Next**.

**Note** : The date of the restore point is displayed in bold font.



4. Confirm the selected restore point and click **Next**. System Restore shuts down Windows, and starts the restoration processes.
5. After the restoration is complete, Windows restarts. In the [System Restore completed] dialog box, click **OK**. Your computer has been restored to the selected restore point.

## ■ Undoing the last restoration

The procedures to undo a restoration are described below.

1. Click **Start > All Programs > Accessories > System Tools > System Restore.**
2. Select 'Undo my last restoration', and click **Next**.
3. Confirm the restoration information to undo, and click **Next**. System Restore shuts down Windows and starts undoing the restoration.
4. After the undo restoration is complete, Windows restarts. On the [Undo the last restoration completed] dialog box, click **OK**. Your computer has been restored to the point prior to the last restoration.

## Reinstalling Software

If you have reinstalled the Windows operating system, or the system and program do not operate properly, you can re-install the driver and program using the System Software Media.

**Note** : This computer is optimized for Microsoft Windows XP, therefore drivers for other operating systems are not included on the System software Media.

### Running the system software media

Insert the system software media into the CD-ROM drive. The initial screen appears automatically.

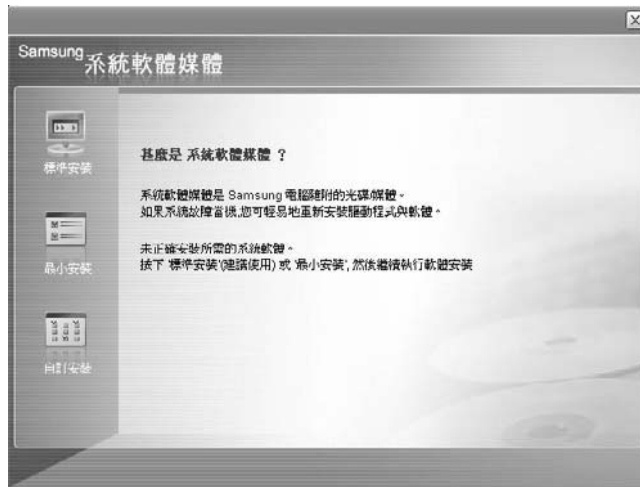

- **Standard Installation** : This displays a list of drivers or programs that are not currently installed on your computer from the system software media provided. All necessary components are installed using the factory defaults.
- **Minimum Installation** : This displays the components (driver, Windows programs, etc) that, if not installed, may cause problems with the system performance. You can install only required components.
- **Custom Installation** : You can customize the installation of drivers and programs.

## ■ Installing drivers and programs

1. Click **Standard Installation** in the main window of the System Software Media. (Standard Installation is recommended)
2. The system is scanned to display the drivers and programs that need to be installed.
3. Click **OK**. The drivers and programs are automatically installed as factory defaults.



4. When done, restart the system.

## Re-Installing Windows

When Windows is not operating properly due to an error on the hard disk drive, you can easily reinstall Windows using the Samsung Recovery Solution Media.

- Caution** : **Please backup your hard disk drive.**
- Samsung Recovery Solution formats your hard disk drive before installing Windows. Therefore, please backup important data onto a separate storage device before reinstallation.
  - **When using a partitioned hard disk drive:**
  - If there is insufficient free disk space for installing Windows (approximately less than 5 GB), Windows cannot be installed.

1. Insert the **Samsung Recovery Solution** media into the DVD-ROM drive and restart your computer.
2. When the **Press any key to boot from DVD. . .** message appears, press any key on the keyboard.  
After a while, the Samsung Recovery Solution Start screen appears.
3. Read the instructions on the Start screen and click the Start button to install Windows.





4. The Windows installation will be performed. Installation will take approximately 15~20 minutes depending on the performance of the computer.



**Note** : If the **Select Windows version (language)** screen appears instead of the **Windows installation** screen:  
: The **Select Windows version** screen may appear if you have formatted your hard disk drive. Select a **Windows version** according to the following procedures.

- 4-1 Select the **Windows version** you have used and click the **Start** button.



- 4-2 The Confirmation window appears. Confirm the selected Windows version and click the **Yes** button.

- When the Windows installation is complete, the computer will automatically restart and the **Notice** window will appear.

Insert the **System Software Media** into the DVD-ROM drive.

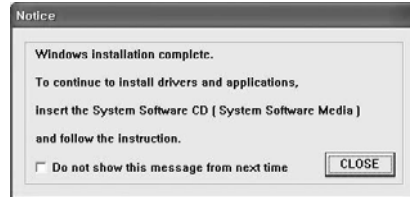

After a short wait, the System Software Media Start screen will appear.

**Note** : The drivers and applications from the System Software Media need to be installed. Windows cannot be used without them.

- Select a menu from the **System Software Media Start screen**, and install the drivers and application programs.

When the installation is complete, the computer will automatically restart and the Windows registration screen will appear.

**Note** : For more information about the procedures to use the **System Software Media**, refer to the descriptions of 'P. 7-5 Re-Installing Software'.  
: **If the System Software Media consists of 2 CDs**  
: When the installation of the first CD is complete, the Windows registration screen appears. (See Step 7) Install the second CD after registering Windows.

- When **Start Microsoft Windows** appears, click the **Next** button.

**Note** : Register Windows referring to the descriptions of the '**Installing and Registering Microsoft Windows**' section of the Installation Guide.  
: If the **System Software Media** consists of two CDs, insert the second CD for program installation into the DVD-ROM drive after completing the Windows registration.

## Q&A

This section provides information on possible problems, solutions and other references for system use.

### Windows Related

#### **Q1**The system does not shutdown properly.



- A When the system does not shutdown normally, press and hold the Power button until the system manually shuts off. If the Power-Saving Mode is configured into the Power button, press and hold for more than 4 seconds to shut the system off. When the system is turned on after such manual shutdown, Scandisk will run to check errors in the system.

#### **Q2**The system freezes during program operation

- A1 There is an error with the program currently being used. Press the <Ctrl>, <Alt>, and <Delete> keys simultaneously and click 'End Task in the [Windows Task Manager] window.
- A2 There is an error with the Windows OS. Reboot the system by using the Power button.

## Display Related

### Q1 The LCD screen is too dark or too bright.

- A Turn on the LCD backlight or adjust the screen brightness. Press <Fn>+<F5> to turn on the LCD backlight or press <Fn>+<>, <Fn>+<> to adjust the screen brightness.

### Q2 The screen saver disturbs screen viewing during Media Player or video file operation.

- A Unselect Tools > Option > Player > Allow screen saver during playback in the Media Player.

### Q3 In DOS mode, changing the full screen DOS mode by pressing <ALT>+<Enter> key displays a broken image for a short period.

- A The DOS mode which supports 2 Byte characters such as Korean and Japanese runs in graphic not in text mode. In this case, a broken image may be displayed while changing the video mode settings.

### Q4 In the following cases, the screen blinks or displays noise for a short time:

(Click the Graphics Related tab, Change Resolution, Change Display Device, Remove the AC Adapter, Restart the System.)

- A This may happen while the video driver is examining the connected device. While detecting, any connected display devices may blink or some noise may occur.

### Q5 When I connect a projector, and change the setting to display screen image on both the LCD and the projector by pressing <Fn>+<> keys, screen is not displayed properly.

- A Press <Fn>+<> keys once again.  
If the same problem continues, it means the projector cannot support the resolution. Lower the resolution to 1024 x 768.

### Q6 The playback screen of a DVD title or an MPEG file is only displayed on the LCD.

- A Video is displayed on a single display device by default, when both LCD and CRT are selected simultaneously.  
1. Right-click over the Desktop and select **Properties** from the pop-up menu.

2. In the [Display Properties] window, select the **Settings** tab > **Advanced** > **CATALYST Control Center** tab.
3. Click the **ATI CATALYST Control Center** button and run the **CATALYST Control Center**.
4. From the View menu, select the Advanced View item.
5. Select Avivo Video > Theater Mode and set the Clone Mode Overlay Display item to Theater Mode. You can then view the video on both LCD and CRT.

**Q7 After connecting to a TV, some programs such as Debug, Mem, etc. do not run in full screen MS-DOS mode.**

- A If a TV is used as the display device, some programs such as Debug, Mem, etc. may not run properly in full screen MS-DOS mode. Run the programs in the MS-DOS window.

**Q8 The Taskbar on the bottom of the screen does not appear when a projector is used as the display device.**

- A A This may happen, even though WXGA LCD supports the 1280 x 800 mode, the projector does not support that mode. In this case change the resolution to 1024x768 (recommended) on your computer.

**Q9 When a TV is connected, the Turn off monitor power option is not performed.**

- A When connecting a TV after booting up your computer, the Turn off monitor power option may not be performed. For it to operate properly, it is recommended to connect a TV and then booting up the computer.

**Q10 The color is strange when the picture is displayed on the connected monitor (or projector).**

- A Check the monitor signal cable connection and reconnect the cable.

**Q11 If I run the Catalyst Control Center of the graphics driver, it appears on the screen after some time.**

- A Since the Catalyst Control Center is developed based on the .Net Framework of Microsoft, some time is required to define the .Net Framework settings when launched for the first time.

**Q12 I have connected a TV with a cable that converts S-Video to Composite, but the picture is displayed abnormally on the screen.**

- A This system supports connecting a TV with an S-Video or Component cable but does not support connecting a TV through a Composite interface with a cable that converts S-Video to Composite.

## Sound Related

### Q1 How to install and uninstall the sound driver

- A To install or uninstall the sound driver from this system, please follow the procedures below.

- **Sound Driver Components**

The sound driver consists of the following 3 components and the 3 components are automatically installed during the installation.

- **High Definition Audio - KB888111**: Microsoft UAA Bus Driver for High Definition Audio
- **Realtek High Definition Audio**: Realtek High Definition Audio
- **Samsung EDS**

- **Uninstalling the Sound Driver**

To remove the sound driver due to a problem or for an update, follow the procedures below.

If you do not follow the sequence below, the sound driver may not be removed or the reinstalled driver, or may not work properly.

1. Select **Start > Control Panel > Add or Remove Programs**.
2. Remove **Samsung EDS** first.
3. Remove **Realtek High Definition Audio Driver** and restart the computer.

**Caution** : Do not remove the **High Definition Audio** item. Removing this item also removes the modem device driver.  
: If you have removed this item, you need to install the modem device driver again.

- **Reinstalling the Sound Driver**

If there is an already installed sound driver, uninstall the driver according to the procedures above.

The sound driver is included on the System Software Media.

1. Insert the System Software CD-ROM into the CD-ROM drive.
2. Select the Sound Driver on either Standard Installation or Custom Installation, then the 3 components of the sound driver are automatically installed.

- **Installing the Sound Driver after a Windows XP Reinstallation**

If you install the sound driver after reinstalling Windows XP, the Add Hardware Wizard (Modem Device) window may appear during the sound driver installation. This happens because the **High Definition Audio - KB888111** Hotfix, which has been installed on your system, has changed the settings to search for both sound and modem devices. If you install the modem device, this message will not appear. If necessary, install the modem device together.

**Note** : The number of the High Definition Audio - KB888111 Hotfix may differ if you have updated the Hotfix from the Microsoft web site.

## Modem Related

### Q1 I cannot hear the modem sound.

A1 Check that the telephone line is properly connected to the modem.

A2 Check that the modem driver is installed properly.

1. Click **Start > Control Panel > Performance and Maintenance > System**.
2. Select **Hardware** tab > **Device Manager > Modems** in the **System Properties** window, and check if there is a yellow exclamation mark on the installed modem icon. If there is, delete the modem device driver and reinstall the driver, because the yellow exclamation mark represents a not properly installed driver.
3. If there is no yellow exclamation mark, double-click the installed modem, and click **Diagnostics** tab > **Query Modem** in the **Modem Properties** window to diagnose the modem.

No message in either of Command and Response in the **Diagnostics** tab means that the modem is not operating properly.

Diagnose the modem again after restarting the system or reinstalling the driver. (You have to exit all programs using modem in the advance of diagnostics of the modem).

### Q2 I cannot make a call using an extension line.

- A In general, the dial tone of a PABX or a digital phone switching system is not a continuous one, unlike that of a trunk line. Therefore, the modem may not make a call because the modem mistakes the dial tone from a PABX or a digital phone switching system as a busy tone. In this case, complete the following procedures.

#### • Using an AT command

As an initialization command, use the command, ATX3. Otherwise, enter the ATX3 command manually before making a call. It can correct this problem by skipping the dial tone check step.

#### • Configuring the Modem through the Control Panel

1. Click **Start > Control Panel > Network and Internet Connections**
2. Under **See Also**, click **Phone and Modem Options**.
3. In the **Modems** tab, select the installed modem, and click **Properties**.
4. In the **Modem** tab of the **Modem Properties** window, clear the **'Wait for dial tone before dialing'** check box.
5. When the configuration is completed, click **OK**.



### **Q3 How do I use my modem when dialing from overseas?**

- A1 Check that the modem is correctly configured according to the current country. Because the values for communication may differ according to the country, you may not be able to connect via the modem due to an incorrect modem configuration.
1. Click **Start > Control Panel > Network and Internet Connections**.
  2. Under **See Also**, click **Phone and Modem Options**.
  3. In the **Dialing Rules** tab, click **Edit**.
  4. In the **General** tab in the **Edit Location** window, select the current country from the **Country/region** radio box, specify the **Area code**, and click **OK**.
- A2 Because the shape of the telephone plug may differ according to the country, you have to purchase and use the appropriate telephone plug for that particular country.

### **Q4 How do I receive a fax while the system is in power saving mode (Rest mode)?**

- A To receive a fax in Standby Mode, you have to set it up as follows.
1. The automatic fax reception function of the fax program needs to be activated. (For more information, refer to the corresponding fax program manual.)
  2. Click **Start > Control Panel > Network and Internet Connections**.
  3. Under **See Also**, click **Phone and Modem Options**.
  4. In the **Modems** tab, select the installed modem, and click **Properties**.
  5. In the Power Management tab of the Modem Properties window, select the "With this device, exit the computer from stand-by mode" item and then click **OK**.

The above setting enables the modem to turn on the system and receive a fax when in power saving mode.

## Wired LAN Related

### Q1 <Wake On LAN> Function.

A <Wake On LAN> function is a function that activates the system in rest mode(S3) when a signal (such as a **Ping** or **Magic Packet** commands) arrives from network(wired LAN).

#### ► To use <Wake On LAN> function

1. Select **My Network Environment > View Network Connections** from the Desktop.
2. Click the right button on the touchpad over **Local Area Connection**, and select **Properties**.
3. Click **Configure...**, and select **Power Management** tab. Select '**Allow this device to bring the computer out of standby**', then click **OK**. Restart the system.

- If the system in rest mode is activated when there is no received signal, use the system after disabling <Wake On LAN> function.
- If you turn the power off when <Wake On LAN> is disabled, the LAN LED may continue to be lit up.
- Connecting wired LAN while using wireless LAN may not execute <Wake On LAN> function. Configure wireless LAN to '**Disable**' to use <Wake On LAN> function.

1. Click on **My Network Place> View network connections** on the Desktop.
2. Right-click over **Wireless Network Connection** and select **Disable**.

### Q2 When I connected 100Mbps wired LAN and the computer exits standby/hibernate mode, a message informing 10Mbps wired LAN connection appears.

A When the computer exits standby/hibernate mode, restoring the network takes about 3 seconds. When the network is restored, it operates in 100Mbps.

## Wireless LAN Related

**Q1 The Wireless LAN device is operating properly, but I cannot connect to the Internet or to another computer. This is due to an incorrect configuration, or a configuration error. Check the following check lists:**

- A1 If you are using a computer-to-computer (Ad Hoc) network connection, check that the name of the configured network (SSID) is correct. The network name (SSID) is case sensitive.
- A2 If you are using a network key (encryption key), you have to use the same network keys for an AP (Access Point) or a computer-to-computer network (Ad Hoc). The network key of the AP is configured in the AP management program. Ask your network administrator or AP manager for more detailed information.
- A3 Check that the device driver is properly installed. If the driver is not properly installed, you will find a yellow exclamation mark on the network icon by clicking Start > Control Panel > Performance and Maintenance > System > Hardware tab > Device Manager > Network adapters > Wireless LAN adapter. If there is a yellow exclamation mark, please reinstall the device driver with the system software Media.
- A4 Referring to A2 of Q3, Check that the network bridge configuration is correct.

**Q2 The signal strength is excellent, but I cannot connect to the network.**

- A1 Even if the signal strength is excellent, the network connection may not operate properly if the TCP/IP properties are not properly configured, or the network key (encryption key) is incorrect. A1 Check that the TCP/IP properties are configured properly. When you connect to an AP, click the Wireless Network Connection icon on the taskbar and select the Support tab. If the IP is not allocated properly, the IP address will be displayed as follows (e.g. 169.254.xxx.xxx). If the network does not provide DHCP, you have to specify the correct IP address by asking your network administrator.  
Even if the network provides DHCP, the server may not allocate an IP address to the client properly, and the client station cannot connect to the network.
- A2 Referring to A2 of Q1, check that the network key is correct.
- A3 Referring to Q4, check that AP is operating properly.

### **Q3 I cannot connect to the AP.**

#### **Check the Computer Settings**

- A1 Verify whether the wireless LAN function of the computer is on by doing the following. If the wireless LAN function is off, turn it on.- For Windows XP, verify that the wireless network connection has been set to "Enable" in Start > Control Panel > Network Connections.- Check if the wireless LAN is turned on.
- A2 Verify whether the same network key (encryption key) has been entered in both the AP and the computer.  
The network key is an encryption key for encrypting data transmitted between the AP and the computer. It is recommended setting the network key manually.

#### **Check the AP Settings**

For the AP settings, refer to the User's Guide provided by the AP manufacturer.

- A3 Verify whether the environment is suitable for using a wireless LAN.  
The use of a wireless LAN may be restricted according to the environment and distance. Obstacles such as walls or doors affect the use of a wireless LAN. Install the AP in a high and open space 50cm from the wall and far removed from any other radio signal sources.
- A4 Verify whether the AP is operating properly.- When the AP is not operating normally, turn off the AP and after a short while turn it on again.- Verify whether the AP's firmware is the most recent version. (Contact the AP manufacturer or the place where you purchased the AP for details of the AP firmware.)
- A5 Verify whether the AP has been properly connected to the network.  
Verify whether the network is operating normally by connecting the wired network cable, which has been connected to the AP, to your computer.
- A6 Check the network key settings (encryption key).When automatic code conversion (a passphrase function) has been selected and data communication is not functioning even with a normal wireless connection, it is recommended entering the network key (encryption key) manually.
- A7 Check the AP settings as follows. (The following is recommended for a standard environment and thus may differ according to the specific wireless network environment.)
- When several APs are present simultaneously, check the channel setting for each AP. When different APs are using nearby channels, interference may occur between electronic waves. Set the APs' channels further apart from each other. (Ex: Ch1, Ch5, Ch9, Ch13)
  - When an AP's SSID (Service Set ID) option is set to "Hide", you cannot search for that AP on the computer. We recommend canceling the "Hide" option for an AP. The SSID is a name for distinguishing one wireless LAN from another wireless LAN.
  - It is recommended using Long Preamble. Preamble is a signal for data transmission synchronization. Short Preamble may be supported by some types of APs but may cause compatibility problems.

- It is recommended using a static IP.
- Since static channel selection is more reliable than auto channel selection, it is recommended setting a static channel.

**Q4 In the Windows XP 'Available wireless networks' window, the Wireless Network Connection is displayed as 'Not Available'.**

- A1 Check if the wireless LAN is turned on.
- A2 Check if there is additional program for a wireless LAN connection installed. Windows XP supports wireless LAN connections through the Wireless Zero Configuration (WZC) service. Therefore, an additional program for wireless LAN connection is not required, unless the network requires a specific program. However, installation of some wireless LAN related programs may sometimes disable the [View Available Wireless Networks] window supported by WZC service. Exit the wireless LAN related program then check whether the window is enabled.
- A3 Initialize the device driver. Click Start > Control Panel > Performance and Maintenance > System > Hardware tab > Device Manager > Network adapters, and select the wireless LAN adapter. Right-click the network adaptor and select 'Disable'. Then right-click over the network adaptor and select 'Enable' after a short wait to check that the device is operating properly.
- A4 Right-click the My computer icon, and select Manage. When the Computer Management window appears, double-click Services and Applications on the left, and then click Services from the sub menu tree. Select the Standard tab in the right pane, double-click Wireless Zero Configuration and check that Startup Type is configured to Automatic, and the Service status is Started.
- A5 In the case of Windows XP, click Advanced in the [Wireless Network Connection] dialog box (see "Connecting to an Access Point (AP)" (p50)) and make sure that 'Use Windows to configure my wireless network settings' is selected. This may happen when a third-party wireless network setup program other than Windows XP default program is installed. For setting up a wireless network using the Windows XP program, this option should be selected.

**Q5 When connecting to a computer-to-computer (Ad Hoc) network, I cannot connect to another computer connected to the same computer-to-computer network.**

- A Make sure that the security settings and network name of the computer-to-computer (Ad Hoc) network is correct. A2 Check the TCP/IP properties of the computers to be connected through the computer-to-computer (Ad Hoc) network. All of the computers to be connected through a computer-to-computer (Ad Hoc) network should be configured so that their IP addresses are within the same subnet range.

- If the TCP/IP Settings are configured to DHCP, the address is automatically configured to an address within the subnet IP range. This will take about 2~3 minutes.
- If the IP address is configured to static IP in TCP/IP properties, select Use the following IP address in the TCP/IP properties of the wireless adapter, configure IP address: 10.0.0.1~10.0.0.254, and Subnet mask: 255.255.0.0, and then try again.
- A fixed IP is recommended for a small-size network.

**Q6 When using a computer-to-computer (Ad Hoc) network, sometimes I cannot search the access point.**

- A It may happen occasionally when you are using a computer-to-computer (Ad Hoc) network connection. Even if you cannot find some access points, the computer-to-computer (Ad Hoc) network is operating properly. Click Refresh to view the latest search result.

**Q7 The network does not operate properly when both the wireless and the wired network connections are simultaneously configured with the same IP address.**

- A You cannot use the wireless and the wired network connections using the same IP address simultaneously. To use either the wireless or the wired network in turn with the same IP address, you have to Disable whichever network device will not be used in the network connection of the Control Panel.

**Q8 The wireless LAN does not work properly when there is a device operating on an adjacent frequency in the vicinity of the product.**

- A1 Channel interference may occur when a wireless video transceiver or a microwave oven is being used. If you experience channel interference from other equipment, we recommend changing the channel to connect to the AP. For more information about AP settings, refer to the User Manual supplied by the AP manufacturer.
- A2 Since IEEE802.11g equipment operates in hybrid mode when there is active IEEE802.11b equipment, the data rate may be degraded.

**Q9 An established wireless LAN connection is disconnected after 2~3 minutes, and the connection is not recovered.**

A1 This may be caused by channel interference. Change the channel of the AP, and reconnect.

A2 This may be caused by selecting the 'Use IEEE 802.1x network authentication' option when IEEE 802.1x authentication is not available.

Check the properties of the AP in the wireless network settings. If the 'Use IEEE 802.1x authentication in this network' option is selected, deselect the option on the Authentication tab.

For more detailed information about authentication server, ask your network administrator.

A3 If the AP is configured to 'Use network authentication (Shared Key)' If the AP is configured to authentication shared mode, all computers to be connected should be configured as follows: If you are using Windows XP, select network authentication (shared mode) in the wireless network settings. Select Start > Control Panel > Network and Internet Connections > Network Connections, right-click the Wireless Network Connection icon and then select View Available Wireless Networks. Select Change Advanced Settings from the left menu, select an AP from Preferred networks window in the Wireless Networks tab, and click the Properties button. Select Shared Mode in the Network Authentication field of the Association tab, and then click the OK button.

If the Preferred networks window in the Wireless Network tab is empty, click View Wireless Networks, select an AP to connect to, and select Shared Mode in the Network Authentication field of the Connection Information tab as described above. For more detailed network authentication procedures, ask your AP (Access Point) administrator.

**Q10 Wireless LAN Setup Program is installed, The "AEGIS Protocol (IEEE 802.1x) v2.2.1.0" appears in the [Local Area Connection Properties] window.**

A The AEGIS Protocol is a security authentication protocol that is automatically installed when Wireless LAN Setup Program is installed and does not affect the operation of other programs.

## Game/Program Related

### Q1 3D game is not executed, or some functions are not working.

- A Change the graphic setting of the game to '2D' or 'Software Renderer', then execute the program again.



### Q2 I launched a game right after installing it, and the game is not executed.

- A This problem may occur when the game is not compatible with Windows XP. Launch the game again, and it will be executed properly.

### Q3 <Fn>+< > Key combination does not work.

A While displaying video of VCD or MPEG, or the display setting is Dual View, you cannot toggle display devices. Also the installation of NetWare Client 32 program disables the function of <Fn>+< >.

### Q4 While playing a game, pressing the <Fn>+< > keys does not work or the screen is not properly displayed.

- A Some games and 3D application programs may change the display device control. Therefore, pressing the <Fn>+< > keys may terminate the running program or may display an abnormal screen.  
Press the <Fn>+< > keys before launching a program and do not press them while running the program.

### Q5 Running speed of a game is too slow or fast.

- A Change the setting of Power Schemes to '**Always On**'.  
(Click **Start > Control Panel > Performance and Maintenance > Power Options > Power Schemes** tab, then configure the **Power schemes** field to '**Always On**'.)

### Q6 Some part of a game image is not displayed or is displayed in black.

- A This may happen when running a game designed for DirectX 8.1, such as NHL 2003, MVP Baseball 2003, etc.



### **Q7 The game screen is displayed small.**

- A This may happen when the display settings are set to zoom out mode ('Use center output'). Change the settings as follows to fit the game screen to the LCD screen.
1. Right-click over the Desktop and select **Properties** from the pop-up menu.
  2. In the [Display Properties] window, select the **Settings** tab > **Advanced** > **CATALYST Control Center** tab.
  3. Click the **ATI CATALYST Control Center** button to run the **CATALYST Control Center**.
  4. From the **View** menu, select the **Advanced View** item.
  5. Select **Notebook Panel Properties > Properties** and set the **Panel Settings** to 'Image Zoom In - Fit to Panel Size' and click the **Apply** button.

### **Q8 Game play is not displayed smoothly on the screen.**

- A For 3D games, the texture data for the 3D screen display is saved to the system memory. If there is insufficient system memory, the data is saved to the hard disk drive and loaded to memory when required. This operation may temporarily stop displaying the picture on the screen.
- In this case, lower the game resolution or the screen settings. (For Delta Force: Black Hawk Down, Medal of Honor, Battle Field, 1942, etc.)

## **Bluetooth**

### **Q1 Characters are broken if I receive a business card in Korean or Chinese using the Bluetooth Send a Business Card function.**

A1 This may happen when you send a Korean or Chinese business card by selecting the **Select a business card from the files (\*.vcf, \*.vcd)** option in the Send a Business Card menu. This is because the contents of the business card file are not set to Korean or Chinese character set (CHARSET). In this case, directly edit the contents of the business card file as follows.

1. Right-click over the business card file to be sent (\*.vcf, \*.vcd) and select **Connect Program > Select Program** from the pop-up menu.
2. Select Notepad from the program list.
3. Edit the contents as follows.

Example) N:MagicSense => N;**CHARSET=KS\_C\_5601**:MagicSense

For Korean, add **CHARSET=KS\_C\_5601**.

For Simplified Chinese (CHS), **CHARSET=gb2312**.

For Traditional Chinese (CHT), **CHARSET=Big5**.

A2 To avoid this problem, send a business card directly from the address book of **Microsoft Outlook** or select the **Select an Outlook business card** option in the Send a Business Card menu and you can now normally send the business card without editing the VCF file.

## **Q2 I cannot find or connect the headset.**

- A1 If the headset is connected to another device and is currently being used, you will not be able to locate it. In this case, even if you locate the headset, you will not be able to connect it. Disconnect the headset from the device and then try again.
- A2 If the headset is connected to the power adapter, the Bluetooth wireless connection is not available. Disconnect the headset from the power adapter and try again.
- A3 A Bluetooth headset generally provides On/Off and Pairing modes. To connect the headset to another Bluetooth device such as a PC or cellphone, it must be in Pairing mode. Switch the headset to Pairing mode and try again.
- In general, a Bluetooth headset in Pairing mode is automatically switched to On/Off mode after a pre-determined period of time.

## **Q3 I have connected the headset, but I cannot hear sound normally.**

- A1 If the Bluetooth headset is properly connected to a PC, the **Control Pane Sound Playback Device** changes to **Bluetooth Audio** (for a mono headset) or **High Quality Bluetooth Audio** (for a stereo headset). If the **Sound Playback Device** in the **Control Panel** is not changed properly, you may not hear any sound. Check the audio settings in the Control Panel according to the procedures below.
- ### **Configuring Sounds and Audio Devices in the Control Panel**
1. Double-Click **Start > Control Panel > Sounds and Audio Devices**.
  2. Select the **Audio** tab in the Sounds and Audio Devices Properties window.
  3. Check if the Sound playback and Sound recording device is set to Bluetooth audio (for a mono headset) or High Quality Bluetooth audio (for a stereo headset).
- A2 When using the Bluetooth headset and another Bluetooth device at the same time, you may hear sound intermittently, may experience data rate degradation or transmission errors, or experience disconnections of the other Bluetooth device. Therefore, avoid using a Bluetooth headset and another Bluetooth device at the same time.
- A3 Check if the headset is properly connected and is operating normally.
- A4 Check the volume settings of the headset and the PC.
- A5 If a multimedia application such as Windows Media Player is running when connecting the headset, the headset may not be connected or recognized properly. Connect the headset first and then launch a multimedia application.

## Security Center

### **Q1 To change the popup window display settings when connected to the Internet.**

In the Windows XP SP2 environment, you can decide whether to display a popup window when connected to the Internet, for user convenience and security.

- A1 To display most of the popup windows when connected to the Internet:
1. Click on Internet Options in Start > Control Panel > Security Center > Manage security settings for.
  2. In the Privacy tab of Internet Properties, clear Block pop-ups.
- A2 To display popup windows only from the current site when connected to the Internet:
- Place the cursor on the notification area at the bottom of the Internet address bar and right-click to display a menu, from which you can select Temporarily Allow Pop-ups or Always Allow Pop-ups from This Site.
- A3 To display popup windows from a particular site:
1. Click on Internet Options in Start > Control Panel > Security Center > Manage security settings for.
  2. In the Privacy tab of Internet Properties, click on Settings from Block pop-ups.
  3. Enter a URL to want to allow pop-ups into Address of Web site to allow and click on Add.
  4. You will find that the entered address is added to the allowed sites list. The next time you connect to the Web site, you will see pop-ups appearing. When you need to re-block a permitted site, select the Web site address that you want to block from the Allowed Sites and click on Remove.

### **Q2 When you connect to a Web site, you see the message, "To help protect your security, Internet Explorer stopped this site from installing an ActiveX control on your computer" or "This site might require the following ActiveX control" below the address bar.**

- A Windows XP SP2 blocks unsigned ActiveX controls from being installed when connected to certain Web sites for security reasons. On some Web sites that have no ActiveX controls installed, applications are not started or do not display properly. In this case, to install ActiveX controls, right-click the notification area to display a menu from which you can select Install ActiveX control.

### **Q3 When you see a Windows Security Alert icon appear on the right part of the task bar.**

With the Security Center feature added, Windows XP SP2 checks the Firewall, the automatic updates configuration and installation of virus-checking programs to display a Windows Security Alert icon on the right part of the task bar when it judges that the computer is vulnerable to attacks from the Internet. In this case, check the following to install the necessary components.

- A1 Set up the Windows Firewall. When you set up the Windows Firewall, you will be protected from unauthorized access through the Internet or the network.
1. Click on Windows Firewall in Start > Control Panel > Security Center > Manage security settings for.
  2. From the General tab of Windows Firewall, select ON (recommended).
  3. If you want to allow a certain program or service to gain access to your computer using the Firewall, select and check the program or service that you want to allow access from, in the Exceptions tab of the Windows Firewall. If you want to add a program to Programs and Services, click on Add Program and select it.
- A2 Set up Windows Automatic Updates.
- This automatically downloads and installs critical updates via the Internet to keep your computer up to date.
1. Click on Automatic Updates in Start > Control Panel > Security Center > Manage security settings for.
  2. From general tab of Automatic Updates window, select Automatic (recommended).
- A3 Keep your computer current with the latest virus updates. (ex: Norton Antivirus)
- Even when you have installed Norton AntiVirus on your computer, Windows cannot recognize the program until you configure the settings, displaying a Security Alert icon. When you first use or install Norton AntiVirus for the first time, follow the Registration Wizard steps to configure the registration settings. To protect your computer from virus attacks with the latest updates, click on Options to display the Norton AntiVirus Options window. From the left menu of the window, check Run Automatic Protection to select Automatic Protection and check Run LiveUpdate to select LiveUpdate.
- A4 Two virus scanning programs on one computer may cause system conflicts. Remove one of the programs from the system.

A5 If Windows does not recognize the existence of an anti-virus program even when it has been installed, your computer could be vulnerable to attacks from the Internet. You should install an anti-virus program that your computer is able to identify.

Check the following programs which Windows can detect and select one from the list.

A list of anti-virus programs that Windows can detect:

- Symantec Norton Anti-Virus
- NetworkAssociates (McAfee)
- TrendMicro
- ComputerAssociates
- Panda
- Kaspersky
- Ahnlabs (AhnLab)

**Note** : The list is subject to change. Visit the Microsoft Web site ([www.microsoft.com](http://www.microsoft.com)) regularly to check the latest list.

# Appendix

## Appendix

System specifications,  
software types and  
safety instructions are  
provided here.

## System Specifications

The system specifications will be described below. The system specifications may differ depending on the derived models.

Item	Specification	Comment
CPU	Intel Celeron M Intel Core™, processor Duo Intel Core™, processor Solo	Optional
Cache memory	2MB / 1MB (Celeron)	Optional
Main memory	512MB / Max 2GB, Memory type : DDR2 SODIMM	Optional
Main Chipset	ATI RC410ME/MD + SB450	Optional
Hard disk drive (HDD)	9.5mmH 2.5" HDD, 60GB	Optional
CD drive	CD-ROM, RW-Combo, DVD Super Multi	Optional
Graphics	ATI Radeon Xpress 200M	Optional
Sound	Realtek ALC262 Codec	
Network Interface	Modem: V.92 Wired LAN: Realtek RTL8100C(L) 10/100 Wireless LAN: 802.11BG Bluetooth 2.0+EDR	Optional Optional Optional Optional
Memory Card Slot	Memory Stick, Memory Stick Pro, SD Card, MMC, Highspeed MMC, xD card Supported	Optional
PC Card Slot	PCMCIA Type I and, II Compatible	Optional
Ports	USB 2.0 x 4, Microphone, Headphone, Modem(RJ-11), LAN(RJ-45), Monitor and TV Out(S-Video), DC Jack, Security Lock Port	Optional
Dimensions (mm)	360 x 264.5 x 26.1~ 37.1mm	W x D x H
LCD	15.4" WXGA (1280 x 800)	
Weight	2.7 ~ 2.74 kg	Optional
Battery	Lithium-Ion smart battery: 6 Cells	
Operation Environment	Temperature (storage) : -5 ~ 40°C (operation) : 10 ~ 32°C Humidity (storage) : 5% ~ 90% (operation) : 20% ~ 80%	
Operation Voltage	100 - 240 VAC	
Frequency	50 - 60 Hz	
Adapter Output Power	60W	
Adapter Output Voltage	19.0VDC	

The system specifications are subject to change without notice. For detailed system specifications, refer to the product catalog.

The capacity of the hard disk drive with Samsung Recovery Solution will be displayed as less than the specified capacity.

# Wireless LAN Specifications (Optional)

## Atheros Wireless Network Adapter

Item		Specifications
Physical Specifications	Dimensions	59.75 X 44.70 mm (Width X Height)
	operation temperature and humidity	Same as system operation specifications Temperature: 0 ~ 70°C, Humidity: less than 85%
Power Specification	Power Saving Mode	70mW
	Receiving Mode	0.825W
	Transmission Mode	1.25W
	Power	3.3V
Network Specifications	Compatibility	IEEE 802.11a, IEEE 802.11b, IEEE 802.11g,
	Operating System	Microsoft Windows XP - NDIS5 Miniport Driver
	Media Access Protocol	CSMA/CA (Collision Avoidance) with Acknowledgement (ACK)
	Security	Wired Equivalent Privacy support (WEP) 64bit/128bit WPA*, CCX*

\* This piece of equipment supports the Wi-Fi wireless LAN security standard, WPA (Wi-Fi Protected Access) and CCX (Cisco Compatible eXtensions). To connect to a wireless network consisting of the WPA and CCX, 1.2.2.8 or higher version of wireless LAN driver have to be installed on your computer, and certificates or PROSet may be required depending on the network settings. For driver update, visit [www.samsung.com](http://www.samsung.com) and for information on the PROSet installation, refer to P. 4-14 "Wireless Network Setup Using the Wireless LAN Setup Program". For more information, ask your network administrator.

## RF Specifications

R-F Frequency Band	2.4GHz
Support Channels	Channels allowed per country.
Device Description	Transceiver
Power	MAX 10 mW
Transmission Method	11b mode : DSSS 11g mode : OFDM
Data Rate (Mbps)*	11b mode : 11, 5.5, 2, and 1 11g mode** : 54, 48, 36, 24, 18, 12, 9, and 6
Antenna Type	Internal Antenna 2 EA (main/aux)

\* The data rate may differ from the actual data rate.

\*\* 11g mode is supported only when the device is connected with an IEEE802.11g device (e.g. IEEE802.11g compatible Access Point).



## Copyright

Samsung Co., Ltd. owns the copyright to this manual. No part of this manual may be reproduced or transmitted in any form or by any means, electronically, mechanically, or through audio, without the consent of Samsung Co., Ltd.

The information in this document is subject to change without prior notice. The manufacturer of this product does not guarantee against data loss. Please ensure that important data is backed up and stored separately to prevent from data loss.

## Registered Trademarks

Samsung is registered trademarks of Samsung Co., Ltd.  
Intel, Pentium/Celeron are registered trademarks of Intel Corporation.  
Microsoft, MS-DOS, and Windows are registered trademarks of Microsoft Corporation.  
Memory Stick and  are trademarks of Sony Corporation.  
All other product or company names mentioned herein are registered trademarks of their respective companies.

This product incorporates copyright protection technology that is protected by method claims of certain U.S. patents and other intellectual property rights owned by Macrovision Corporation and other rights owners. Use of this copyright protection technology must be authorized by Macrovision Corporation, and is intended for home and other limited viewing uses only unless otherwise authorized by Macrovision Corporation. Reverse engineering or disassembly is prohibited.

# Safety Instructions

## Instructions for Setup

- **Set up the system on a stable work surface.**  
If the system is dropped it may be damaged or it may inflict injuries on the user.



- **Set up the system in a clean, dry and airy place.**  
If the system overheats, it may be damaged or it may cause fires.



- **Do not use loose power outlets or damaged power cables.**

There is a danger of electric shocks or fires.



- **Use standard power voltage.**  
High-voltage may result in product damage or cause fires.

- **Use grounded power outlets designed for computers.**  
A grounded power outlet prevents electric shock from electricity leakage.

- **Set up the system away from magnetic objects.**  
Contents of the hard disk drive may be deleted or the color of the monitor may be permanently distorted.



- **Dispose of moisture-reducing agents and plastic packaging properly.**  
Consumption of moisture-reducing agents and placing plastic packaging over the head is fatal, especially for children.

- **A walkie-talkie must be kept more than 1 meter away from the device.**

Since a walkie-talkie transmits a very strong signal, it may cause a computer malfunction.

## Instructions for careful handling

- **Handle with care so as not to damage the data in the hard disk.**

- Since the hard disk is fragile and sensitive to external conditions, it may be damaged from temperature changes or impact during operation. Take extra care to prevent such damages.
- Loss of data due to external conditions or carelessness during use is the user's sole responsibility and the manufacturer shall not be held liable for any compensation.



In order to minimize damages from data loss, please backup data at all times.

- **Cases when the hard disk and data may be damaged:**

- External impacts while separating from or installing into the computer may cause disk or data damage.
- Power failure during hard disk operation resulting in resetting the computer may cause disk or data damage.
- Execution of delete (DEL) or format (FORMAT) commands by mistake may cause loss of data.
- Virus infection may cause unrecoverable loss of data.
- An abrupt power cut during program operation may cause disk or data damage.
- Moving the computer, or impacts to the computer during hard disk operation may cause data loss or bad sectors on the hard disk.

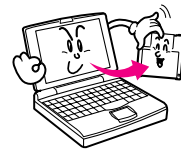

- **Be sure to make backup copies of important data.**

The Manufacturer is not liable for lost data.

- **Turn on peripheral devices before, turning on the computer**

Otherwise damages may occur.

- **Turn off the computer before turning off other peripheral devices.**

Otherwise damages may occur.

- **Do not touch the modem, telephone lines and exposed electrical terminals during a thunder storm**

There is a danger of electric shocks or fires.

- **Before disassembling the system, turn the power off and disconnect the power cable.**

There is a danger of electric shocks.



- **Use only authorized parts and do not disassemble, repair or modify the computer unless at an authorized dealer.**

Use authorized service centers as the system may be damaged.



- **Do not touch the power strip with wet hands.**

There is a danger of electric shock.

- **Place the computer away from heat devices (such as heaters).**

It may damage the system or cause fires.

- **Clean with cleaners specifically for computers**

Do not use benzene, paint thinner, or alcohol to clean the computer. It may damage the product.

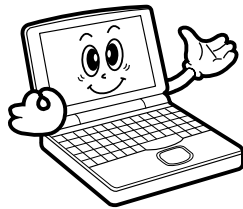

# SAMSUNG Notebook Computer Global Warranty

## 1. What is Global Warranty System (GWS) ?

Warranty Repair Service will be provided by Samsung Electronics Co., Ltd as required during Warranty period.

## 2. What is process ?

- a. The GWS service only applies to the regions mentioned below.
- b. Only products that are subject to GWS, and are within the guarantee period apply.
- c. When the computer unit is damaged (outside of the region purchased), please contact and receive repair services from the local SAMSUNG appointed service center (ASC). Since the repair methods may be different for products purchased locally, please check with the local ASC.
- d. Consultations made locally (outside of the region purchased) can be given in the local language.
- e. Whether a product can or cannot be fixed will be determined after a thorough examination, and the damaged product may not be repaired to its original state, as circumstances may dictate.
- f. When a product cannot be repaired locally (outside of the region purchased) please contact the national SAMSUNG appointed service center for further enquiries.
- g. The only warranty provided under GWS is repair where reasonably practicable, replacement or credit is not supported under this scheme.
- h. The length of time needed to obtain spare parts may depend on the type of part, and in some cases may not be replaceable.
- i. Accessories (such as the battery) or the AC cable, are excluded from the warranty.
- j. The User's Guide, drivers, and the operating system will not be provided and are not purchasable locally (outside of the region purchased).
- k. Software and operating system consultation and repair services will not be provided. When moving abroad (outside of the region purchased), please ensure that the Recovery CD, Software CD, and the User's Guide are taken along as well.
- l. All costs arising from customs duties when moving abroad (outside of the region purchased) are the user's responsibility.
- m. Malfunctions and damages caused by the user's abuse and neglect, or through other circumstances such as fires, earthquakes, floods, lightning, natural disasters, environmental pollution, and abnormal electricity currents will not be covered by the warranty. All other circumstances are subject to conditions in the warranty.

Please refer to <http://www.samsungcomputer.com> .

Rev. 1.4

### Korea - Samsung Contact Center

416, Maetan-3Dong, Yeongtong-Gu, Suwon-City, Gyeonggi-Do, Korea  
Tel: 82 1588 3366  
Homepage: [www.sec.co.kr](http://www.sec.co.kr)

### U.S.A. - IntelISol [Technical Solution for Intelligent Business]

1001 NE Loop 820 Dock 5 Forth Worth, TX 76131, U.S.A.  
Tel: 1 817 230 5293 FAX: 1 817 230 5045  
E-Mail: [SamsungPC.Support@intelisol.com](mailto:SamsungPC.Support@intelisol.com)

### Canada - HINET

425 Superior BLVD. #4 Mississauga, Ontario L5T 2W5, Canada  
Tel: 1 905 565 1211 FAX: 1 905 565 1911  
E-Mail: [hinet@bellnet.ca](mailto:hinet@bellnet.ca)

### U.K. / Ireland - Samsung Call Center

Tel: 44 870 242 0303  
Homepage: [www.Samsung.co.uk](http://www.Samsung.co.uk)

### Germany / Swiss - Samsung Call Center

Tel: 49 1805 121 213 FAX: 49 1805 121 214  
Homepage: [www.samsung.de](http://www.samsung.de)

### France - Samsung Call Center

Tel: 33 8 2508 6565  
Homepage: [www.samsung.fr](http://www.samsung.fr)

### Spain - Samsung Call Center

Tel: 34 902 101 130 FAX: 34 93 262 6766  
Homepage: [www.samsung.com/es](http://www.samsung.com/es)

### Portugal - Samsung Call Center

Tel: 351 808 200 128 FAX: 351 21 425 1001  
Homepage: [www.samsung.com/pt](http://www.samsung.com/pt)

### Australia - Thomas Electronics ESG Australia.

4 Sheridan Close, Milperra NSW 2214, Australia  
Tel: 61 2 9773 7400 FAX: 61 2 9773 7177  
E-mail: [teo@thomas.com.au](mailto:teo@thomas.com.au)

### NewZealand - Datacom Repair Center

Ground Floor 160 Grafton Road Auckland 1005 New Zealand  
Tel: 64 9 356 1457 FAX: 64 9 356 1493  
E-mail: [simont@datacom.co.nz](mailto:simont@datacom.co.nz)

### Japan - Samsung Contact Center

416, Maetan-3Dong, Yeongtong-Gu, Suwon-City, Gyeonggi-Do, Korea  
Tel: 0034-800-40-3366  
Homepage: [www.sec.co.kr](http://www.sec.co.kr)

### Hongkong - Samsung Electronics H.K. CO., Ltd.

11/F, Phase2, MTL Warehouse Building, Berth One, Kwai Chung, NT, Hong Kong  
Tel: 852 2862 6001 FAX: 852 2862 6971  
Homepage: [www.samsung.com/hk](http://www.samsung.com/hk)

### India - Samsung Electronics India Service Center

2nd fl CC-28, Nehru Enclave Kalkaji, New Delhi, India 110019  
Tel: 1600 1100 11, 3030-8282  
Homepage: [www.samsung.com/in](http://www.samsung.com/in)

### Singapore - Samsung Asia Pte. Ltd.

20 Toh Guan Road, Accord Distri Centre #01-01, Singapore 608839  
Tel: 1800 726 7864  
Homepage: [www.samsung.com/sg](http://www.samsung.com/sg)

### Malaysia - Samsung Malaysia Electronics Sdn. Bhd.

3B-1-1. Level 1, Block 3B, Plaza Sentral, Jalan Stesen Sentral 5, KL Sentral, 50470 Kuala Lumpur, Malaysia  
Tel: 1 800 88 9999  
Homepage: [www.samsung.com/my](http://www.samsung.com/my)

### Thailand - Samsung Customer Service Plaza(Bangkok)

1 floor Boonmitr Building 138 Silom Rd., Suriyawong, Bangrak, Bangkok, 10500  
Tel: 1800-29-3232 (0-2689-3232) FAX: 0-2689-3298  
Homepage: [www.samsung.com/th](http://www.samsung.com/th)

## **Customer Service Center**

General Enquiry Hotline: 2862-6001

Technical Support Hotline: 2862-6406

E-mail: [service@sehk.samsung.com](mailto:service@sehk.samsung.com)

### **Web Site:**

<http://www.samsung.com/hk>