

**SAMSUNG**

# Microwave Oven

## Owner's Instructions and Cooking Guide

**G2739N**

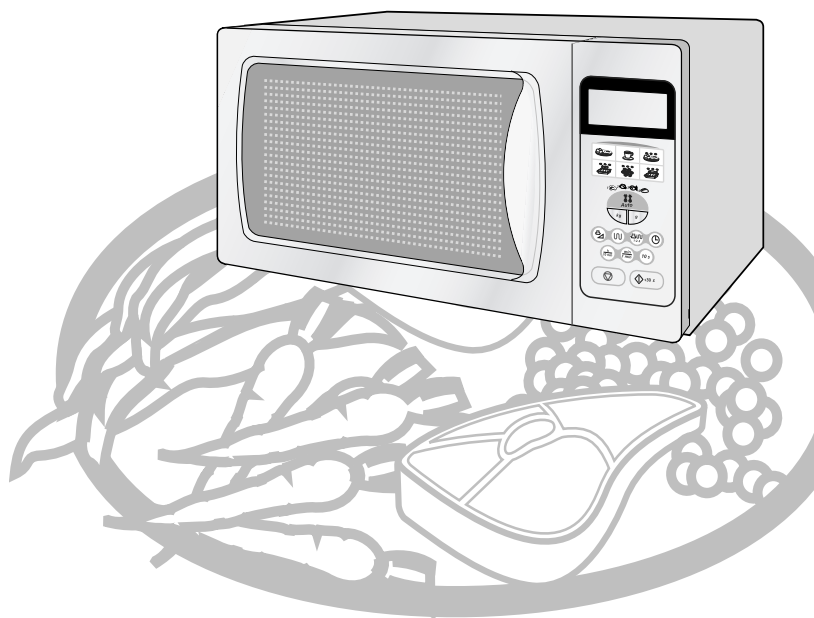

Quick Look-up Guide .....	2
Oven .....	3
Accessories .....	3
Control Panel .....	4
Using this Instruction Booklet .....	4
Safety Precautions .....	5
Installing Your Microwave oven .....	6
Setting the Time .....	6
How a Microwave Oven Works .....	7
Checking that Your Oven is Operating Correctly .....	7
What to Do if You are in Doubt or Have a Problem .....	8
Cooking / Reheating .....	8
Power Levels .....	9
Stopping the Cooking .....	9
Adjusting the Cooking Time .....	9
Using the Instant Reheat/Cook Feature .....	10
Instant Reheat/Cook Settings .....	10
Using the Auto Defrost Feature .....	11
Auto Defrost Settings .....	11
Choosing the Accessories .....	12
Grilling .....	12
Combining Microwaves and the Grill .....	12
Multistage Cooking .....	13
Switching the Beeper Off .....	14
Safety-Locking Your Microwave Oven .....	14
Cookware Guide .....	15
Cooking Guide .....	16
Cleaning Your Microwave Oven .....	23
Storing and Repairing Your Microwave Oven .....	23
Technical Specifications .....	24

## Quick Look-up Guide

EN

### If you want to cook some food



1. Place the food in the oven.  
Select the power level by pressing the  button once or more times.

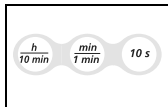



2. Select the cooking time by pressing the **10min**, **1min** or **10s** button as required.

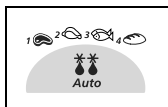

3. Press the  button.  
Result : Cooking starts.  
The oven beeps four times when cooking is over.

### If you want to defrost some food



1. Place the frozen food in the oven.  
Press the **Auto** () button once or more times according to the type of food to be defrosted.

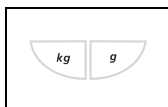

2. Select the weight by pressing the **kg** and **g** buttons as required.



3. Press the  button.



### If you want to add an extra minute





1. Leave the food in the oven.  
Press **+30s** once or more times for each extra 30 seconds that you wish to add.

### If you want to grill some food

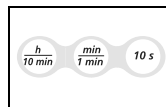

1. Preheat the grill to the required temperature, by pressing the , time setting (**10min**, **1min** and **10s**) and  button.



2. Place the food on the rack in the oven.  
Press the  button. Select the cooking time by pressing the **10min**, **1min** and **10s** buttons.



3. Press the  button.

## Oven

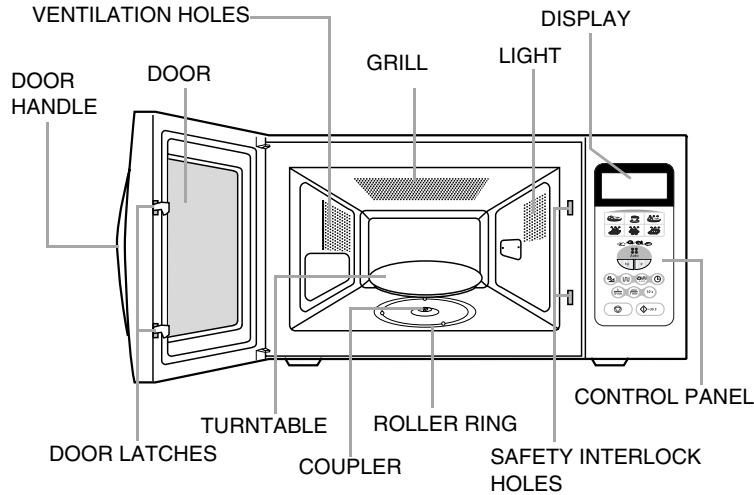

## Accessories

Depending on the model that you have purchased, you are supplied with several accessories that can be used in a variety of ways.

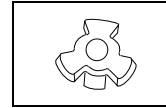

1. **Coupler**, already placed over the motor shaft in the base of the oven.

**Purpose:** The coupler rotates the turntable.

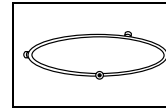

2. **Roller ring**, to be placed in the centre of the oven.

**Purpose:** The roller ring supports the turntable.

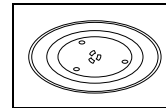

3. **Turntable**, to be placed on the roller ring with the centre fitting to the coupler.

**Purpose:** The turntable serves as the main cooking surface; it can be easily removed for cleaning.

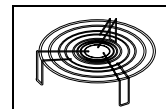

4. **Metal rack**, to be placed on the turntable.

**Purpose:** The metal rack can be used in grill and combination cooking.



**DO NOT** operate the microwave oven without the roller ring and turntable.

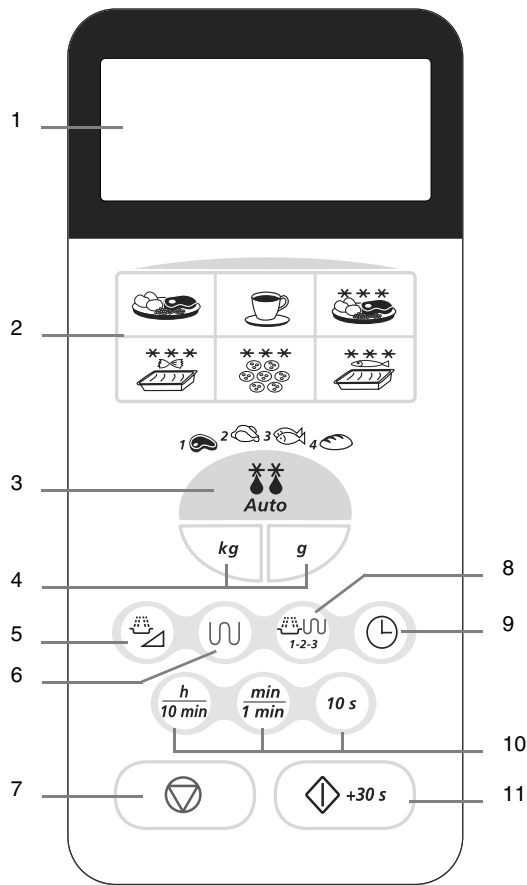

- |                                   |                         |
|-----------------------------------|-------------------------|
| 1. DISPLAY                        | 6. GRILL MODE SELECTION |
| 2. INSTANT REHEAT/COOK SELECTION  | 7. STOP/CANCEL BUTTON   |
| 3. AUTO DEFROST FEATURE SELECTION | 8. COMBI MODE SELECTION |
| 4. WEIGHT SELECTION               | 9. CLOCK SETTING        |
| 5. MICROWAVE MODE SELECTION       | 10. TIME SETTING        |
|                                   | 11. START BUTTON        |

You have just purchased a SAMSUNG microwave oven. Your Owner's Instructions contain much valuable information on cooking with your microwave oven:

- Safety precautions
- Suitable accessories and cookware
- Useful cooking tips

Inside the cover you will find a quick look-up guide explaining three basic cooking operations:

- Cooking food
- Defrosting food
- Grilling food
- Adding extra cooking time

At the front of the booklet you will find illustrations of the oven, and more importantly the control panel, so that you can find the buttons more easily.

The step-by-step procedures use three different symbols.



## PRECAUTIONS TO AVOID POSSIBLE EXPOSURE TO EXCESSIVE MICROWAVE ENERGY

Failure to observe the following safety precautions may result in harmful exposure to microwave energy.

- Under no circumstances should any attempt be made to operate the oven with the door open or to tamper with the safety interlocks (door latches) or to insert anything into the safety interlock holes.
- Do not place any object between the oven door and front face or allow food or cleaner residues to accumulate on sealing surfaces. Ensure that the door and door sealing surfaces are kept clean by wiping after use first with a damp cloth and then with a soft dry cloth.
- Do not operate the oven if it is damaged until it has been repaired by a qualified microwave service technician trained by the manufacturer. It is particularly important that the oven door closes properly and that there is no damage to the:
  - Door (bent)
  - Door hinges (broken or loose)
  - door seals and sealing surfaces
- The oven should not be adjusted or repaired by anyone other than a properly qualified microwave service technician trained by the manufacturer.

## Safety Precautions

### IMPORTANT SAFETY INSTRUCTIONS.

#### READ CAREFULLY AND KEEP FOR FUTURE REFERENCE.

*Before cooking food or liquids in your microwave oven, please check that the following safety precautions are taken.*

- Only use utensils that are suitable for use in microwave ovens;  
**DO NOT** use any metallic containers, Dinnerware with gold or silver trimmings, Skewers, forks, etc.  
Remove wire twist ties from paper or plastic bags.  
**Reason:** Electric arcing or sparking may occur and may damage the oven.
- When heating food in plastic or paper containers, keep an eye on the oven due to the possibility of ignition;  
Do not use your microwave oven to dry newspapers or clothes
- If smoke is observed, switch off or unplug the appliance and keep the door closed in order to stifle any flames;
- Microwave heating of beverages can result in delayed eruptive boiling, therefore care must be taken when handling the container; To prevent this situation  
**ALWAYS** allow a standing time of at least 20 seconds after the oven has been switched off so that the temperature can equalize.  
Stir during heating, if necessary, and **ALWAYS** stir after heating.  
In the event of scalding, follow these **FIRST AID** instructions:
  - \* Immerse the scalded area in cold water for at least 10 minutes.
  - \* Cover with a clean, dry dressing.
  - \* Do not apply any creams, oils or lotions.
- **NEVER** fill the container to the top and choose a container that is wider at the top than at the bottom to prevent the liquid from boiling over. Bottles with narrow necks may also explode if overheated.  
**NEVER** heat a baby's bottle with the teat on, as the bottle may explode if overheated.
- The contents of feeding bottles and baby food jars shall be stirred or shaken and the temperature checked before consumption, in order to avoid burns;
- Eggs in their shell and whole hard-boiled eggs should not be heated in microwave ovens since they may explode, even after microwave heating has ended;  
Also do not heat airtight or vacuum-sealed bottles, jars, containers, nuts in shells, tomatoes etc.
- The oven should be cleaned regularly and any food deposits removed;
- Failure to maintain the oven in a clean condition could lead to deterioration of the surface that could adversely affect the life of the appliance and possibly result in a hazardous situation;
- **DO NOT** cover the ventilation slots with cloths or paper. They may catch fire as hot air is evacuated from the oven.  
The oven may overheat and automatically switch itself off. It will remain inoperable until it has cooled sufficiently.
- **ALWAYS** use oven gloves when removing a dish from the oven to avoid unintentional burn.
- **DO NOT** touch heating elements or interior oven walls until the oven be cooled down.

- Do not immerse the power cable or plug in water and keep the power cable away from heated surfaces.  
Do not operate this appliance if it has a damaged power cable or plug.
- Stand at arms length from the oven when opening the door.  
**Reason:** The hot air or steam released may cause scalding.
- You may notice a Clicking sound during operation (especially when the oven is defrosting).  
**Reason:** This sound is normal when the electrical power output is changing.
- **DO NOT** operate the microwave oven when it is empty. The power will be cut off automatically for safety. You can operate normally after letting it stand for over 30 minutes.  
It is best to leave a glass of water inside the oven at all times. The water will absorb the microwaves energy if the oven accidentally started.

### IMPORTANT

- Young children should **NEVER** be allowed to use or play with the microwave oven. Nor should they be left unattended near the microwave oven when it is in use. Items of interest to children should not be stored or hidden just above the oven.
- This appliance is not intended for use by persons (including children) with reduced physical, sensory or mental capabilities, or lack of experience and knowledge, unless they have been given supervision or instruction concerning use of the appliance by a person responsible for their safety.
- Children should be supervised to ensure that they do not play with the appliance.
- During use the appliance becomes hot. Care should be taken to avoid touching heating elements inside the oven.
- **DO NOT** use harsh abrasive cleaners or sharp metal scrapers to clean the oven door glass since they can scratch the surface, which may result in shattering of the glass. (If provided)

### WARNING:

If the door or door seals are damaged, the oven must not be operated until it has been repaired by a competent person.

### WARNING:

It is hazardous for anyone other than a competent person to carry out any service or repair operation which involves the removal of a cover which gives protection against exposure to microwave energy.

### WARNING:

Liquids and other foods must not be heated in sealed containers since they are liable to explode.

### WARNING:

Only allow children to use the oven without supervision when adequate instructions have been given so that the child is able to use the oven in a safe way and understands the hazards of improper use.

### WARNING:

When the appliance is operated in the combination mode, children should only use the oven under adult supervision due to the temperatures generated.

### WARNING:

- Accessible parts may become hot during use. Young children should be kept away.
- The microwave oven shall not be placed in a cabinet
  - For safety reasons do not clean the appliance with a steam jet or high pressure cleaner.

## Installing Your Microwave oven

Place the oven on a flat level surface 85cm above the floor. The surface should be strong enough to safely bear the weight of the oven.

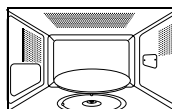
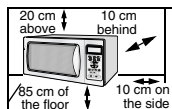

1. When you install your oven, make sure there is adequate ventilation for your oven by leaving at least 10 cm (4 inches) of space behind and, on the sides of the oven and 20 cm (8 inches) of space above.
2. Remove all packing materials inside the oven. Install the roller ring and turntable. Check that the turntable rotates freely.
3. This microwave oven has to be positioned so that plug is accessible.

☛ If the supply cord is damaged, it must be replaced by a special cord or assembly available from the manufacturer or its service agent. For your personal safety, plug the cable into a 3-pin, 230 Volt, 50Hz, AC earthed socket. If the power cable of this appliance is damaged, it must be replaced by a special cable.

☛ Do not install the microwave oven in hot or damp surroundings like next to a traditional oven or radiator. The power supply specifications of the oven must be respected and any extension cable used must be of the same standard as the power cable supplied with the oven. Wipe the interior and the door seal with a damp cloth before using your microwave oven for the first time.

## Setting the Time

Your microwave oven has an inbuilt clock. The time can be displayed in either the 24-hour or 12-hour notation. You must set the clock:

- **When you first install your microwave oven**
- **After a power failure**

✉ Do not forget to reset the clock when you switch to and from summer and winter time.



1. To display the time in the... Then press the ⌚ button...  
24-hour notation                      Once  
12-hour notation                        Twice

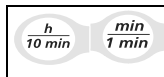

2. Set the hour with the **h** button and the minutes with the **min** button.



3. When the right time is displayed, press the ⌚ button again to start the clock.  
**Result :**     The time is displayed whenever you are not using the microwave oven.

## How a Microwave Oven Works

Microwaves are high-frequency electromagnetic waves; the energy released enables food to be cooked or reheated without changing either the form or the colour.

You can use your microwave oven to:

- Defrost
- Instant Reheat/Cook
- Cook

### Cooking Principle

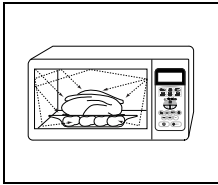

1. The microwaves generated by the magnetron are distributed uniformly as the food rotates on the turntable. The food is thus cooked evenly.
2. The microwaves are absorbed by the food up to a depth of about 1 inch (2.5 cm). Cooking then continues as the heat is dissipated within the food.
3. Cooking times vary according to the recipient used and the properties of the food:
  - Quantity and density
  - Water content
  - Initial temperature (refrigerated or not)

- As the centre of the food is cooked by heat dissipation, cooking continues even when you have taken the food out of the oven. Standing times specified in recipes and in this booklet must therefore be respected to ensure:
- Even cooking of the food right to the centre
  - The same temperature throughout the food

## Checking that Your Oven is Operating Correctly

The following simple procedure enables you to check that your oven is working correctly at all times. Open the oven door by pushing the large button in the bottom right-hand corner of the control panel.

First, place a bowl of water on the turntable. Then, close the door.

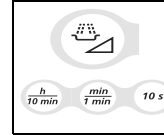

1. Press the  button and set the time to 4-5 minutes by pressing the **1min** button the appropriate number of times.



2. Press  button.  
Result : The oven heats the water for 4 to 5 minutes. The water should then be boiling.





The oven must be plugged into an appropriate wall socket. The turntable must be in position in the oven. If a power level other than the maximum is used, the water takes longer to boil.

## What to Do if You are in Doubt or Have a Problem

EN

If you have any of the problems listed below try the solutions given.

- ◆ This is normal.
  - Condensation inside the oven
  - Air flow around the door and outer casing
  - Light reflection around the door and outer casing
  - Steam escaping from around the door or vents
  
- ◆ The oven does not start when you press the  button.
  - Is the door completely closed?
  
- ◆ The food is not cooked at all
  - Have you set the timer correctly and/or pressed the  button?
  - Is the door closed?
  - Have you overloaded the electric circuit and caused a fuse to blow or a breaker to be triggered?
  
- ◆ The food is either overcooked or undercooked
  - Was the appropriate cooking length set for the type of food?
  - Was an appropriate power level chosen?
  
- ◆ Sparking and cracking occur inside the oven (arcing)
  - Have you used a dish with metal trimmings?
  - Have you left a fork or other metal utensil inside the oven?
  - Is aluminium foil too close to the inside walls?
  
- ◆ The oven causes interference with radios or televisions
  - Slight interference may be observed on televisions or radios when the oven is operating. This is normal. To solve this problem, install the oven away from televisions, radios and aerials.
  - If interference is detected by the oven's microprocessor, the display may be reset. To solve this problem, disconnect the power plug and reconnect it. Reset the time.

## Cooking / Reheating

The following procedure explains how to cook or reheat food. ALWAYS check your cooking settings before leaving the oven unattended.

First, place the food in the centre of the turntable. Then, close the door.



1. Press the  button.

Result: The 750W (maximum cooking power) indications are displayed:

Select the appropriate power level by pressing the  button again until the corresponding wattage is displayed. Refer to the power level table on the next page.

2. Set the cooking time by pressing the **10min. 1min** and **10s** button.

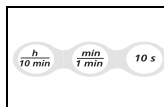

3. Press the  button.

Result: The oven light comes on and the turntable starts rotating.

- 1) Cooking starts and when it has finished the oven beeps four times.
- 2) The end reminder signal will beep 3 times (once every minute).
- 3) The current time is displayed again.



**Never** switch the microwave oven on when it is empty.







If you wish to heat a dish for a short period of time at maximum power (750W), simply press the **+30s** button once for each 30 seconds of cooking time. The oven starts immediately.



## Power Levels

You can choose among the power levels below.

Power Level	Output	
	MWO	GRILL
HIGH	750 W	-
MEDIUM HIGH	600 W	-
MEDIUM	450 W	-
MEDIUM LOW	300 W	-
DEFROST( ** )	180 W	-
LOW/KEEP WARM	100 W	-
GRILL	-	950 W
COMBI I (  )	600 W	950 W
COMBI II (  )	450 W	950 W
COMBI III(  )	300 W	950 W

-  If you select higher power level, the cooking time must be decreased. If you select lower power level, the cooking time must be increased.



## Stopping the Cooking

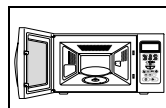

You can stop cooking at any time to check the food.



1. To stop temporarily;  
Open the door.  
**Result :** Cooking stops. To resume cooking, close the door and press  again.



2. To stop Completely;  
Press the  button.  
**Result :** The cooking stops.  
If you wish to cancel the cooking settings, press the **Cancel**(  ) button again.

-  You can cancel any setting before starting cooking by simply pressing **Cancel** .

## Adjusting the Cooking Time

You can increase the cooking time by pressing the **+30s** button once for each 30 seconds to be added.



Press the **+30s** button once for each 30 seconds to be added.

-  You can not adjust the time during cooking when Auto modes are selected.

## Using the Instant Reheat/Cook Feature

With the **Instant Reheat and Cook** feature, the cooking time is set automatically and you do not have to press the  button. You can adjust the number of servings by pressing the appropriate **Instant Reheat and Cooking** button the required number of times.

First, place the food in the centre of the turntable and close the door.

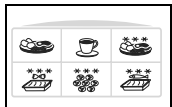



Press the **Instant Reheat and Cook** button which you want the required number of times.

**Result:** Cooking starts after about two seconds.

When it has finished:







- 1) The oven beeps four times.
- 2) The end reminder signal will beep 3 times. (once every minute)
- 3) The current time is displayed again.

**Example:** Press the  button once times to reheat one cups of coffee. Refer to the table on the next page for further details.

 Use only recipients that are microwave-safe.

## Instant Reheat/Cook Settings

The following table presents the various **Instant Reheat & Cook** Programmes, quantities, standing times and appropriate recommendations.

Food / Button	Serving Size	Standing Time	Recommendations
<b>Ready Meal</b> (chilled) 	300-350 g 400-450 g	3 min.	Put on a ceramic plate and cover with microwave cling film. This programme is suitable for meals consisting of 3 components (e.g. meat with sauce, vegetables and a side dish like potatoes, rice or pasta).
<b>Drinks</b> (Coffee, milk, tea, water with room temperature) 	150 ml (1 cup) 250 ml (1 mug)	1-2 min.	Pour in to a ceramic cup and reheat uncovered. Place cup (150ml) or mug (250ml) in the centre of turntable, Stir carefully before and after standing time.
<b>Ready Meal</b> (frozen) 	300-350 g 400-450 g	4 min.	Take frozen ready meal and check if dish is suitable for microwave. Pierce film of ready meal. Put the frozen ready meal in the centre. This programme is suitable for frozen ready meals consisting of 3 components (e.g. meat with sauce, vegetables and a side dish like potatoes, rice or pasta).
<b>Pasta Gratin</b> (frozen) 	200 g 400 g	2-3 min.	Put the frozen pasta gratin into a suitable sized glass pyrex dish. Put the dish on the rack. This programme is suitable for frozen pasta gratin such as lasagne, cannelloni or macaroni.
<b>Mini - Quiches/ Mini-Pizzas</b> (frozen) 	150 g (4-6pcs) 250 g (7-9pcs)	-	Put the frozen mini-quiches or mini-pizzas evenly on the rack.
<b>Fish Gratin</b> (frozen) 	200 g 400 g	2-3 min.	Put the frozen fish gratin into a suitable sized glass pyrex dish. Put the dish on the rack. This programme is suitable for frozen ready products consisting of fish fillets topped with vegetables and sauce.

## Using the Auto Defrost Feature

The Auto Defrost feature enables you to defrost meat, poultry or fish. The defrost time and power level are set automatically. You simply select the programme and the weight.

 Use only dishes that are microwave-safe.

First, place the frozen food in the centre of the turntable and close the door.

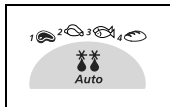

1. Press the **Auto**(\*\*\*) button.  
**Result :** The following indication is displayed:



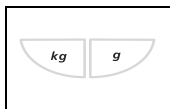

Press the **Auto**(\*\*\*) button one or more times according to the type of food to be defrosted. Refer to the table on the next page for further details.



2. Select the food weight by pressing the **kg** and **g** button.







3. Press  button.  
**Result :**
  - ◆ Defrosting begins.
  - ◆ The oven beeps halfway through defrosting to remind you to turn the food over.
  - ◆ Press  again to finish defrosting. When it has finished.
    - 1) The oven beeps four times.
    - 2) he end reminder signal will beep 3 times (once every minute).
    - 3) The current time is displayed again.

 You can also defrost food manually. To do so, select the microwave cooking/reheating function with a power level of 180W. Refer to the section entitled "Cooking/Reheating" on page 9 for further details.

## Auto Defrost Settings

The following table presents the various Auto Defrost programmes, quantities, standing times and appropriate recommendations.

Remove all kinds of package material before defrosting. Place meat, poultry and fish on a ceramic plate.

Code	Food	Portion	Standing Time	Recommendations
1	 Meat	200 - 1500 g	20-60 min.	Shield the edges with aluminium foil. Turn the meat over when the oven beeps. This programme is suitable for beef, lamb, pork, steaks, chops and minced meat.
2	 Poultry	200 - 1500 g	20-60 min.	Shield the leg and wing tips with aluminium foil. Turn the poultry over when the oven beeps. This programme is suitable for whole chicken and chicken portions.
3	 Fish	200 - 1500 g	20-50 min.	Shield the tail of the whole fish with aluminium foil. Turn the fish over when the oven beeps. This programme is suitable for whole fishes and fish fillets.
4	 Bread/ Cake	125 - 625 g	5-20 min.	Put bread on a piece of kitchen paper and turn over, as soon as the oven beeps. Place cake on a ceramic plate and if possible, turn over, as soon as the oven beeps. (Oven keeps operating and is stopped, when you open the door. This programme is suitable for all kinds of bread, sliced or whole, as well as for bread rolls and baguettes. Arrange bread rolls in a circle. This programme is suitable for all kinds of yeast cake, biscuit, cheese cake and puff pastry. It is not, suitable for short/crust pastry, fruit and cream cakes as well as for cake with chocolate topping.

 Select the Manual Defrosting function with a power level of 180 W if you want to defrost food manually. For further details on manual defrosting and defrosting time, refer to the page 20.

## Choosing the Accessories

Use microwave-safe recipients; do not use plastic containers, dishes, paper cups, towels, etc.

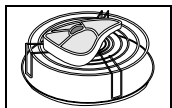



If you wish to select the combined cooking mode (grill and microwave), use only dishes that are microwave-safe and oven-proof. Metallic cookware or utensils may damage your oven.

For further details on suitable cookware and utensils, refer to the Cookware Guide on page 15.

## Grilling

The grill enables you to heat and brown food quickly, without using microwaves. To this aim, a grill rack is supplied with your microwave oven.



1. Preheat the grill to the required temperature, by pressing the , time setting (10min, 1min and 10s) and  button.

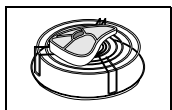

2. Open the door and place the food on the rack.

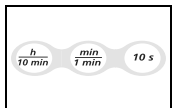

3. Place the food on the rack in the oven. Press the  button. Select the cooking time by pressing the 10min, 1min and 10s buttons. (The maximum grilling time is 60 minutes.)



4. Press the  button.  
**Result:** The oven light comes on and the turntable starts rotating.



- 1) Cooking starts and when it has finished the oven beeps four times.
- 2) The end reminder signal will beep 3 times (once every minute).
- 3) The current time is displayed again.

Do not worry if the heater turns off and on while grilling. This system is designed to prevent overheating of the oven.

Always use oven gloves when touching the dishes in the oven, as they will be very hot.

## Combining Microwaves and the Grill

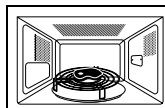

You can also combine microwave cooking with the grill, to cook quickly and brown at the same time.

-  **ALWAYS** use microwave-safe and oven-proof cookware. Glass or ceramic dishes are ideal as they allow the microwaves to penetrate the food evenly.
-  **ALWAYS** use oven gloves when touching the recipients in the oven, as they will be very hot.



1. Open the door and place the food on the rack and the rack on the turntable. Close the door.



2. Press the **Combi** () button.  
**Result:** The following indications are displayed:  
 (microwave and grill mode)  
**600W** (out power)

Select the appropriate **power level** by pressing the **Combi** () button again until the corresponding power level is displayed.

You cannot set the temperature of the grill.

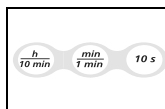

3. Set the cooking time by pressing the **10min**, **1min** and **10s** buttons. The maximum cooking time is 60 minutes.



4. Press the  button.  
**Result:** Combination cooking starts. When it has finished.

- 1) The oven beeps four times.
- 2) The end reminder signal will beep 3 times (once every minute).
- 3) The current time is displayed again.

The maximum microwave power for the combined microwave and grill mode is 600W.

## Multistage Cooking

Your microwave oven can be programmed to cook food up to three stages.

**Example:** You wish to defrost food and cook it without having to reset the oven after each stage. You can thus defrost and cook a 500g fish in three stages:

- Defrosting
- Cook I
- Cook II

- ☒ You can set between two and three stages in multistage cooking
- ☒ If you set three stage, the first stage must be defrosting.
- ☒ Don't press  button until you've set the final stage.

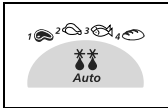

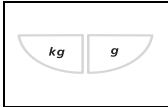

1. Press the **Auto** () button once or more times.



2. Set the weight by pressing the **kg** and **g** buttons the appropriate number of times(500g in the example).



3. Press the  button.  
The microwave mode(I):  
 ; if necessary, set the power level by pressing the  button again one or more times.  
(600W in the example)

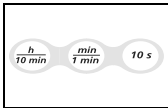

4. Set the cooking time by pressing the **10min**, **1min** and **10s** buttons the appropriate number of times(4 minutes in the example).



5. Press the  button.  
The grill mode(II):

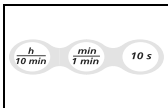

6. Set the cooking time by pressing the **10min**, **1min** and **10s** buttons the appropriate number of times(5 minutes in the example).  
(The maximum grilling time is 60 minutes.)



7. Press the  button.

**Result:**

The three modes [defrosting and cooking(I,II)] are selected one after the other. According to the defrosting mode that you have chosen, the oven may beep halfway through defrosting to remind you to turn the food over. When cooking is over, the oven beeps four times.

- ◆ The end reminder signal will beep 3 times (once every minute).
- ◆ The current time is displayed again.

## Switching the Beeper Off

You can switch the beeper off whenever you want.



1. Press the ⏏ and +30s buttons at the same time.  
**Result :** The oven will not beep each time you press a button.

OFF



2. To switch the beeper back on, press the ⏏ and +30s buttons again at the same time.  
**Result :** The oven operates with the beeper on again.

On

## Safety-Locking Your Microwave Oven

Your microwave oven is fitted with a special Child Safety programme, which enables the oven to be “locked” so that children or anyone unfamiliar with it cannot operate it accidentally.

The oven can be locked at any time.



1. Press the ⏏ and ⏏ buttons at the same time.  
**Result :** The oven is locked (no functions can be selected).

L



2. To unlock the oven, press the ⏏ and ⏏ buttons again at the same time.  
**Result :** The oven can be used normally.

## Cookware Guide

To cook food in the microwave oven, the microwaves must be able to penetrate the food, without being reflected or absorbed by the dish used.

Care must therefore be taken when choosing the cookware. If the cookware is marked microwave-safe, you do not need to worry.

The following table lists various types of cookware and indicates whether and how they should be used in a microwave oven.

Cookware	Microwave-Safe	Comments
<b>Aluminium foil</b>	✓ X	Can be used in small quantities to protect areas against overcooking. Arcing can occur if the foil is too close to the oven wall or if too much foil is used.
<b>Browning plate</b>	✓	Do not preheat for more than eight minutes.
<b>China and earthenware</b>	✓	Porcelain, pottery, glazed earthenware and bone china are usually suitable, unless decorated with a metal trim.
<b>Disposable polyester cardboard dishes</b>	✓	Some frozen foods are packaged in these dishes.
<b>Fast-food packaging</b>		
• Polystyrene cups containers	✓	Can be used to warm food. Overheating may cause the polystyrene to melt. May catch fire.
• Paper bags or newspaper	X	
• Recycled paper or metal trims	X	May cause arcing.
• Glassware		
<b>Glassware</b>		
• Oven-to-table ware	✓	Can be used, unless decorated with a metal trim.
• Fine glassware	✓	Can be used to warm foods or liquids. Delicate glass may break or crack if heated suddenly.
• Glass jars	✓	Must remove the lid. Suitable for warming only.

<b>Metal</b>		
• Dishes	X	May cause arcing or fire.
• Freezer bag twist ties	X	
<b>Paper</b>		
• Plates, cups, napkins and Kitchen paper	✓	For short cooking times and warming. Also to absorb excess moisture.
• Recycled paper	X	May cause arcing.
<b>Plastic</b>		
• Containers	✓	Particularly if heat-resistant thermoplastic. Some other plastics may warp or discolour at high temperatures. Do not use Melamine plastic.
• Cling film	✓	Can be used to retain moisture. Should not touch the food. Take care when removing the film as hot steam will escape.
• Freezer bags	✓ X	Only if boilable or oven-proof. Should not be airtight. Prick with a fork, if necessary.
<b>Wax or grease-proof paper</b>	✓	Can be used to retain moisture and prevent spattering.

✓ :Recommended

✓X:Use Caution

X :Unsafe

# Cooking Guide

EN

## MICROWAVES

Microwave energy actually penetrates food, attracted and absorbed by its water, fat and sugar content.

The microwaves cause the molecules in the food to move rapidly. The rapid movement of these molecules creates friction and the resulting heat cooks the food.

### COOKING

#### Cookware for microwave cooking:

Cookware must allow microwave energy to pass through it for maximum efficiency. Microwaves are reflected by metal, such as stainless steel, aluminium and copper, but they can penetrate through ceramic, glass, porcelain and plastic as well as paper and wood. So food must never be cooked in metal containers.

#### Food suitable for microwave cooking:

Many kinds of food are suitable for microwave cooking, including fresh or frozen vegetables, fruit, pasta, rice, grains, beans, fish, and meat. Sauces, custard, soups, steamed puddings, preserves, and chutneys can also be cooked in a microwave oven. Generally speaking, microwave cooking is ideal for any food that would normally be prepared on a hob. Melting butter or chocolate, for example (see the chapter with tips, techniques and hints).

#### Covering during cooking

To cover the food during cooking is very important, as the evaporated water rises as steam and contributes to cooking process. Food can be covered in different ways: e.g. with a ceramic plate, plastic cover or microwave suitable cling film.

#### Standing times

After cooking is over food the standing time is important to allow the temperature to even out within the food.

## Cooking Guide for frozen vegetables

Use a suitable glass pyrex bowl with lid. Cook covered for the minimum time - see table. Continue cooking to get the result you prefer.

Stir twice during cooking and once after cooking. Add salt, herbs or butter after cooking. Cover during standing time.

Food	Portion	Power	Time (min.)	Standing Time(min.)	Instructions
Spinach	150g	600W	5½-6½	2-3	Add 15 ml (1 tablespoon) cold water.
Broccoli	300g	600W	10-11	2-3	Add 15 ml (1 tbsp.) cold water.
Peas	300g	600W	8-9	2-3	Add 15 ml (1 tbsp.) cold water.
Green Beans	300g	600W	10-11	2-3	Add 15 ml (1 tbsp) cold water.
Mixed Vegetables (carrots/peas/corn)	300g	600W	9-10	2-3	Add 15 ml (1 tbsp.) cold water.
Mixed Vegetables (Chinese style)	300g	600W	8½-9½	2-3	Add 15 ml (1 tbsp) cold water.



## Cooking Guide(continued)

### Cooking Guide for rice and pasta

**Rice:** Use a large glass pyrex bowl with lid - rice doubles in volume during cooking. Cook covered. After the cooking time is over, stir before standing time and salt or add herbs and butter.  
Remark: the rice may not have absorbed all water after the cooking time is finished.

**Pasta:** Use a large glass pyrex bowl. Add boiling water, a pinch of salt and stir well. Cook uncovered. Stir occasionally during and after cooking. Cover during standing time and drain thoroughly afterwards.

Food	Portion	Power	Time (min.)	Standing Time(min.)	Instructions
White Rice (parboiled)	250g	750W	17-18	5	Add 500 ml cold water.
Brown Rice (parboiled)	250g	750W	22-23	5	Add 500 ml cold water.
Mixed Rice (rice + wild rice)	250g	750W	18-19	5	Add 500 ml cold water.
Mixed Corn (rice + grain)	250g	750W	19-20	5	Add 400 ml cold water.
Pasta	250g	750W	11-12	5	Add 1000 ml hot water.

### Cooking Guide for fresh vegetables

Use a suitable glass pyrex bowl with lid. Add 30-45 ml cold water (2-3 tbsp.) for every 250 g unless another water quantity is recommended - see table. Cook covered for the minimum time - see table. Continue cooking to get the result you prefer. Stir once during and once after cooking. Add salt, herbs or butter after cooking. Cover during a standing time of 3 minutes.

**Hint:** Cut the fresh vegetables into even sized pieces. The smaller they are cut, the quicker they will cook.

**All fresh vegetables should be cooked using full microwave power (750 W).**

Food	Portion	Time (min.)	Standing Time (min.)	Instructions
Broccoli	250g 500g	5-5½ 8½-9	3	Prepare even sized florets. Arrange the stems to the centre.
Brussels Sprouts	250g	6½-7½	3	Add 60-75 ml (5-6 tbsp.) water.
Carrots	250g	5-6	3	Cut carrots into even sized slices.
Cauliflower	250g 500g	5½-6 9½-10	3	Prepare even sized florets. Cut big florets into halves. Arrange stems to the centre.
Courgettes	250g	4-4½	3	Cut courgettes into slices. Add 30 ml (2 tbsp.) water or a knob of butter. Cook until just tender.
Egg Plants	250g	4½-5	3	Cut egg plants into small slices and sprinkle with 1 tablespoon lemon juice.
Leeks	250g	5-5½	3	Cut leeks into thick slices.
Mushrooms	125g 250g	1½-2 3½-4	3	Prepare small whole or sliced mushrooms. Do not add any water. Sprinkle with lemon juice. Spice with salt and pepper. Drain before serving.
Onions	250g	5-6	3	Cut onions into slices or halves. Add only 15 ml (1 tbsp.) water.
Pepper	250g	4½-5	3	Cut pepper into small slices.
Potatoes	250g 500g	5-6 9-10	3	Weigh the peeled potatoes and cut them into similar sized halves or quarters.
Turnip Cabbage	250g	5-5½	3	Cut turnip cabbage into small cubes.

### REHEATING

Your microwave oven will reheat food in a fraction of the time that conventional ovens hobs normally take.

Use the power levels and reheating times in the following chart as a guide. The times in the chart consider liquids with a room temperature of about +18 to +20°C or a chilled food with a temperature of about +5 to +7°C.

#### Arranging and covering

Avoid reheating large items such as joint of meat - they tend to overcook and dry out before the centre is piping hot. Reheating small pieces will be more successful.

#### Power levels and stirring

Some foods can be reheated using 750 W power while others should be reheated using 600 W, 450 W or even 300 W.

Check the tables for guidance. In general, it is better to reheat food using a lower power level, if the food is delicate, in large quantities, or if it is likely to heat up very quickly (mince pies, for example).

Stir well or turn food over during reheating for best results. When possible, stir again before serving.

Take particular care when heating liquids and baby foods. To prevent eruptive boiling of liquids and possible scalding, stir before, during and after heating. Keep them in the microwave oven during standing time. We recommend putting a plastic spoon or glass stick into the liquids. Avoid overheating (and therefore spoiling) the food.

It is preferable to underestimate cooking time and add extra heating time, if necessary.

#### Heating and standing times

When reheating food for the first time, it is helpful to make a note of the time taken - for future reference.

Always make sure that the reheated food is piping hot throughout.

Allow food to stand for a short time after reheating - to let the temperature even out.

The recommended standing time after reheating is 2-4 minutes, unless another time is recommended in the chart.

Take particular care when heating liquids and baby food. See also the chapter with the safety precautions.

### REHEATING LIQUIDS

Always allow a standing time of at least 20 seconds after the oven has been switched off to allow the temperature to even out. Stir during heating, if necessary, and ALWAYS stir after heating. To prevent eruptive boiling and possible scalding, you should put a spoon or glass stick into the beverages and stir before, during and after heating.

### REHEATING BABY FOOD

**BABY FOOD:** Empty into a deep ceramic plate. Cover with plastic lid. Stir well after reheating! Let stand for 2-3 minutes before serving. Stir again and check the temperature. Recommended serving temperature: between 30-40°C.

**BABY MILK:** Pour milk into a sterilised glass bottle. Reheat uncovered. Never heat a baby's bottle with teat on, as the bottle may explode if overheated. Shake well before standing time and again before serving! Always carefully check the temperature of baby milk or food before giving it to the baby. Recommended serving temperature: ca. 37°C.

#### REMARK:

Baby food particularly needs to be checked carefully before serving to prevent burns.

Use the power levels and times in the next table as a guide lines for reheating.

## Cooking Guide(continued)

### Reheating Liquids and Food

Use the power levels and times in this table as a guide lines for reheating.

Food	Portion	Power	Time (min.)	Standing Time (min.)	Instructions
Drinks (coffee, milk, tea, water with room temperature)	150ml (1 cup) 250ml (1 mug)	750W	1½-2 2-2½	1-2	Pour in to a ceramic cup and reheat uncovered. Place cup (150ml) or mug (250ml) in the centre of turntable, Stir carefully before and after standing time.
Soup (chilled)	250g 450g	750W	3-3½ 4-4½	2-3	Pour into a deep ceramic plate. Cover with plastic lid. Stir well after reheating. Stir again before serving.
Stew (chilled)	350g	600W	5-6	2-3	Put stew in a deep ceramic plate. Cover with plastic lid. Stir occasionally during reheating and again before standing and serving.
Pasta with sauce (chilled)	350g	600W	4-5	3	Put pasta (e.g. spaghetti or egg noodles) on a flat ceramic plate. Cover with microwave cling film. Stir before serving.
Filled pasta with sauce (chilled)	350g	600W	4½-5½	3	Put filled pasta (e.g. ravioli, tortellini) in a deep ceramic plate. Cover with plastic lid. Stir occasionally during reheating and again before standing and serving.
Plated Meal (chilled)	300g 400g	600W	5-6 6-7	3	Plate a meal of 2-3 chilled components on a ceramic dish. Cover with microwave cling-film.

Food	Portion	Power	Time (min.)	Standing Time (min.)	Instructions
Frozen Ready Meal	300g 400g	600W	11½-12½ 13-14	4	Put microwave proof dish with frozen ready meal (-18°C) on the turntable. Pierce film or cover with microwave cling film. After reheating stand for 4 minutes.

### Reheating Baby Food and Milk

Use the power levels and times in this table as guide lines for reheating.

Food	Portion	Power	Time	Standing Time (min.)	Instructions
Baby food (vegetables + meat)	190g	600W	30sec.	2-3	Empty into ceramic deep plate. Cook covered. Stir after cooking time. Stand for 2-3 minutes. Before serving, stir well and check the temperature carefully.
Baby porridge (grain + milk + fruit)	190g	600W	20sec.	2-3	Empty into ceramic deep plate. Cook covered. Stir after cooking time. Stand for 2-3 minutes. Before serving, stir well and check the temperature carefully.
Baby milk	100ml 200ml	300W	30-40sec. 1 min. to 1 min.10sec.	2-3	Stir or shake well and pour into a sterilised glass bottle. Place into the centre of turn-table. Cook uncovered. Shake well and stand for at least 3 minutes. Before serving, shake well and check the temperature carefully.

EN

## Cooking Guide(continued)

### DEFROSTING

Microwaves are an excellent way of defrosting frozen food. Microwaves gently defrost frozen food in a short period of time. This can be of great advantage, if unexpected guests suddenly show up.

Frozen poultry must be thoroughly thawed before cooking. Remove any metal ties and take it out of any wrapping to allow thawed liquid to drain away.

Put the frozen food on a dish without cover. Turn over half way, drain off any liquid and remove any giblets as soon as possible.

Check the food occasionally to make sure that it does not feel warm. If smaller and thinner parts of the frozen food start to warm up, they can be shield by wrapping very small strips of aluminium foil around them during defrosting.

Should poultry start to warm up on the outer surface, stop thawing and allow it to stand for 20 minutes before continuing.

Leave the fish, meat and poultry to stand in order to complete defrosting. The standing time for complete defrosting will vary depending on the quantity defrosted. Please refer to the table below.

**Hint:** Flat food defrosts better than thick and smaller quantities need less time than bigger ones. Remember this hint while freezing and defrosting food.

For defrosting of frozen food with a temperature of about -18 to -20 °C, use the following table as a guide.

All frozen food should be defrosted using defrosting power level (180 W).

Food	Portion	Time (min.)	Standing Time (min.)	Instructions
Meat	Minced beef	500g	10-12	5-20 Place the meat on a flat ceramic plate. Shield thinner edges with aluminium foil. Turn over after half of defrosting time!
	Pork steaks	250g	7-8	
Poultry	Chicken pieces	500g (2 pcs)	12-14	15-40 First, put chicken pieces first skin-side down, whole chicken first breast-side-down on a flat ceramic plate. Shield the thinner parts like wings and ends with aluminium foil. Turn over after half of defrosting time!
	Whole chicken	1000g	25-28	
Fish	Fish fillets	250g (2 pcs)	6-7	5-20 Put frozen fish in the middle of a flat ceramic plate. Arrange the thinner parts under the thicker parts. Shield narrow ends with aluminium foil. Turn over after half of defrosting time!
		400g (4 pcs)	11-13	
Fruits	Berries	250g	6-7	5 - 10 Distribute fruits on a flat, round glass dish (with a large diameter).
Bread	Bread rolls (each ca. 50 g)	2 pcs	1½-2	5 - 10 Arrange rolls in a circle or bread horizontally on kitchen paper in the middle of turntable. Turn over after half of defrosting time!
		4 pcs	3-4	
	Toast/ Sandwich	250g	4-5	
	German bread (wheat+ rye flour)	500g	8-10	

## Cooking Guide(continued)

### GRILL

The grill-heating element is located underneath the ceiling of the cavity. It operates while the door is closed and the turntable is rotating. The turntable's rotation makes the food brown more evenly. Preheating the grill for 4 minutes will make the food brown more quickly.

#### Cookware for grilling:

Should be flameproof and may include metal. Do not use any type of plastic cookware, as it can melt.

#### Food suitable for grilling:

Chops, sausages, steaks, hamburgers, bacon and gammon rashers, thin fish portions, sandwiches and all kinds of toast with toppings.

#### IMPORTANT REMARK:

Whenever the grill only mode is used, make sure that the grill-heating element is under the ceiling in the horizontal position and not on the back-wall in the vertical position. Please remember that food must be placed on the high rack, unless another instruction is recommended.

### MICROWAVE + GRILL

This cooking mode combines the radiant heat that is coming from the grill with the speed of microwave cooking. It operates only while the door is closed and the turntable is rotating. Due to the rotation of the turntable, the food browns evenly. Three combination modes are available with this model: 600 W + Grill, 450 W + Grill and 300 W + Grill.

#### Cookware for cooking with microwave + grill

Please use cookware that microwaves can pass through. Cookware should be flameproof. Do not use metal cookware with combination mode. Do not use any type of plastic cookware, as it can melt.

#### Food suitable for microwave + grill cooking:

Food suitable for combination mode cooking include all kinds of cooked food which need reheating and browning (e.g. baked pasta), as well as foods which require a short cooking time to brown the top of the food. Also, this mode can be used for thick food portions that benefit from a browned and crispy top (e.g. chicken pieces, turning them over half way through cooking). Please refer to the grill table for further details.

#### IMPORTANT REMARK:

Whenever the combination mode (microwave + grill) is used, make sure that the grill heating element is under the ceiling in the horizontal position and not on the back-wall in the vertical position. The food should be placed on the high rack, unless another instruction is recommended. Otherwise it has to be placed directly on the turntable. Please refer to the instructions in the following chart.

The food must be turned over, if it is to be browned on both sides.

### Grill Guide

**Preheat the heater with the grill-function when grilling fresh and frozen food.**

Use the power levels and times in this table as guide lines for grilling.

Fresh Food	Portion	Preheat Time (min.)	Power	1. Side Time (min)	2. Side Time (min.)	Instructions
Toast Slices	4 pcs (4 x 25g)	5	Grill only	6-7	5-6	Put the toast slices side by side on the rack.
Bread Rolls (already baked)	2-4 pieces	3	Grill only	3-4	2-3	Put bread rolls first with the bottom side up in a circle directly on the rack.
Grilled Tomatoes	250 g (2pcs)	5	300 W + Grill	5½-6½	--	Cut tomatoes into halves. Put salt, pepper and some cheese on top. Arrange in a circle in a flat glass pyrex dish. Place dish on the rack.
Toast Hawaii	2 pcs (300 g)	5	300 W + Grill	7-9	--	Toast the bread slices first. Put the toast with topping (ham, pineapple, cheese slices) side by side on the rack. After cooking stand for 2-3 minutes.
Chicken Wings (chilled)	400-500g (6pcs)	5	300 W + Grill	11-13	10-12	Prepare chicken pieces such as chicken wings or drumsticks with oil and spices. Put them in a circle on the rack with the bones to the middle. After grilling stand for 2-3 minutes.

## Cooking Guide(continued)

### Grill Guide (continued)

Fresh Food	Portion	Preheat Time (min.)	Power	1. Side Time (min)	2. Side Time (min.)	Instructions
Baked Potatoes	500 g	5	450 W + Grill	10-12	--	Cut potatoes into halves and put in a circle on the rack with the cut side to the grill. Brush cut side with olive oil and spices. After grilling stand for 3 minutes.
Frozen Pasta	400 g	---	600 W + Grill	14-16	3-4	Put the frozen pasta (-18°C), e.g. lasagne, tortellini or cannelloni in a suitable sized glass pyrex dish and set on rack.
Frozen Fish Gratin	400 g	---	600 W + Grill	16-18	3-4	Put the frozen fish gratin (-18°C) in a suitable sized glass pyrex dish and set on rack.
Frozen Pizza Snacks	250 g (8pcs)	---	300 W + Grill	12-13	---	Put the frozen pizza snacks (-18°C) or mini quiches in a circle on the rack.
Frozen Streusel Cake	200-250 g (1-2 pcs)	---	300 W + Grill	4-6	---	Put the frozen cake pieces (-18°C) side by side on rack. After defrosting stand for 5 minutes.

### SPECIAL HINTS

#### MELTING BUTTER

Put 50 g butter into a small deep glass dish. Cover with plastic lid. Heat for 30-40 seconds using 750 W, until butter is melted.

#### MELTING CHOCOLATE

Put 100 g chocolate into a small deep glass dish. Heat for 3-5 minutes, using 450 W until chocolate is melted. Stir once or twice during melting. Use oven gloves while taking out!

#### MELTING CRYSTALLIZED HONEY

Put 20 g crystallized honey into a small deep glass dish. Heat for 20-30 seconds using 300 W, until honey is melted.

#### MELTING GELATINE

Lay dry gelatine sheets (10 g) for 5 minutes into cold water. Put drained gelatine into a small glass pyrex bowl. Heat for 1 minute using 300 W. Stir after melting.

#### COOKING GLAZE/ICING (FOR CAKE AND GATEAUX)

Mix instant glaze (approximately 14 g) with 40 g sugar and 250 ml cold water. Cook uncovered in a glass pyrex bowl for 3½ to 4½ minutes using 750 W, until glaze/icing is transparent. Stir twice during cooking.

#### COOKING JAM

Put 600 g fruits (for example mixed berries) in a suitable sized glass pyrex bowl with lid. Add 300 g preserving sugar and stir well. Cook covered for 10-12 minutes using 750 W. Stir several times during cooking. Empty directly into small jam glasses with twist-off lids. Stand on lid for 5 minutes.

#### COOKING PUDDING

Mix pudding powder with sugar and milk (500 ml) by following the manufacturers instructions and stir well. Use a suitable sized glass pyrex bowl with lid. Cook covered for 6½ to 7½ minutes using 750 W. Stir several times well during cooking.

#### BROWNING ALMOND SLICES

Spread 30 g sliced almonds evenly on a medium sized ceramic plate. Stir several times during browning for 3½ to 4½ minutes using 600 W. Let it stand for 2-3 minutes in the oven. Use oven gloves while taking out!

---

## Cleaning Your Microwave Oven

---

The following parts of your microwave oven should be cleaned regularly to prevent grease and food particles from building up:

- **Inside and outside surfaces**
- **Door and door seals**
- **Turntable and Roller rings**

 **ALWAYS** ensure that the door seals are clean and the door closes properly.

1. Clean the outside surfaces with a soft cloth and warm, soapy water. Rinse and dry.
2. Remove any splashes or stains on the inside surfaces or on the roller ring with a soapy cloth. Rinse and dry.
3. To loosen hardened food particles and remove smells, place a cup of diluted lemon juice on the turntable and heat for ten minutes at maximum power.
4. Wash the dishwasher-safe plate whenever necessary.

 **DO NOT** spill water in the vents. **NEVER** use any abrasive products or chemical solvents. Take particular care when cleaning the door seals to ensure that no particles:

- Accumulate
- Prevent the door from closing correctly

 Clean the microwave oven cavity right after each use with a mild detergent solution, but let the microwave oven cool down before cleaning in order to avoid injury.

---

## Storing and Repairing Your Microwave Oven

---

A few simple precautions should be taken when storing or having your microwave oven serviced.

The oven must not be used if the door or door seals are damaged:

- **Broken hinge**
- **Deteriorated seals**
- **Distorted or bent oven casing**

Only a qualified microwave service technician should perform repair.

 **NEVER** remove the outer casing from the oven. If the oven is faulty and needs servicing or you are in doubt about its condition:

- Unplug it from the wall socket
- Contact the nearest after-sales service centre

 If you wish to store your oven away temporarily, choose a dry, dust-free place.  
Reason: Dust and damp may adversely affect the working parts in the oven.

 This microwave oven is not intended for commercial use.

## Technical Specifications

**SAMSUNG** strives to improve its products at all times. Both the design specifications and these user instructions are thus subject to change without notice.

<b>Model</b>	G2739N
<b>Power source</b>	230V ~ 50 Hz
<b>Power consumption</b>	
Microwave	1100 W
Grill	950 W
Combined mode	2050 W
<b>Output power</b>	100 W / 750 W (IEC-705)
<b>Operating frequency</b>	2450 MHz
<b>Magnetron</b>	OM75S(31)
<b>Cooling method</b>	Cooling fan motor
<b>Dimensions (W x H x D)</b>	
Outside	489 x 275 x 396 mm
Oven cavity	330 x 187 x 320 mm
<b>Volume</b>	20 liter
<b>Weight</b>	
Net	15 kg approx



ELECTRONICS

If you have any questions or comments relating to Samsung products, please contact the SAMSUNG customer care center.

Tel : 3030 8282  
1800 110011  
[www.samsung.com/in](http://www.samsung.com/in)