

SAMSUNG

OWNER'S INSTRUCTIONS

AWT18QBHDA

Window-type Room Air Conditioner (Cool)

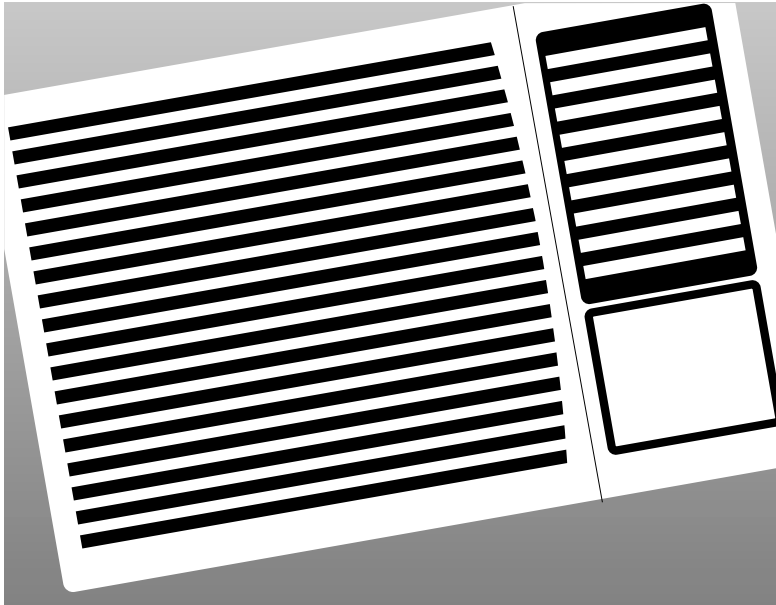

Safety Precautions

The following safety precautions must be taken when using your air conditioner.

- 1 *The unit must be plugged into an independent circuit.
The air conditioner must be installed in accordance with national wiring regulations and safety regulations wherever applicable.*
- 2 *Some installation locations may require installation of a short circuit breaker or grounding.*
- 3 *If the supply cord is damaged, it must be replaced by a special cord or assembly available from the manufacturer or its service agent.*
- 4 *MAKE sure that the unit is correctly ventilated at all times ;
do NOT place clothing or other materials over it.*
- 5 *NEVER spill any kind of liquid into the unit. Should this happen, unplug the unit and contact an authorized service center.*
- 6 *Do NOT insert anything between the air outlet blades because the inner fan may be damaged and could cause injury. Keep children away from the unit.*
- 7 *Do NOT place any obstacles in front of the unit.*
- 8 *Users of this product are cautioned not to attempt repairs.
Instead, they are requested to directly contact a designated service center or the outlet at which the product was purchased.*
- 9 *Do not use an extension cord with this product.*
- 10 *The appliance is not intended for use by young children without supervision ;
young children should be supervised to ensure that they do not play with the appliance.*
- 11 *Never store or ship the air conditioner upside down or sideways to avoid damage to the compressor.*
- 12 *Max current is measured according to IEC standard for safety
and current is measured according to ISO standard for energy efficiency.*

CAUTION

The manufacturer does not assume responsibility for accidents or injury caused by an incorrectly installed air conditioner. If you are unsure about installation, contact an installation specialist.

Contents

◆ PREPARING YOUR AIR CONDITIONER	
■ Safety Precautions	2
■ Description of Each Component	4
■ Remote Control - Buttons	5
■ Getting Started	6
■ Inserting the Remote Control Batteries	7
◆ OPERATING YOUR AIR CONDITIONER	
■ Cooling Your Room	8
■ Ventilating Your Room	9
■ Adjusting the Air Flow Direction Horizontally	10
■ Adjusting the Air Flow Direction Vertically	11
◆ PROGRAMMING YOUR AIR CONDITIONER	
■ Setting the On Timer	12
■ Setting the Off Timer	13
■ Setting the Sleep Timer	14
■ Selecting Energy Saving mode	15
◆ RECOMMENDATIONS FOR USE	
■ Operating Recommendation	16
■ Temperature and Humidity Ranges	16
■ Cleaning Your Air Conditioner	17
■ Solving Common Problems	18
■ Technical Specifications	19
◆ INSTALLATION	20

Description of Each Component

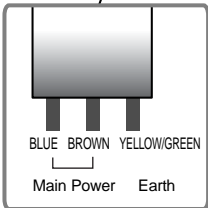
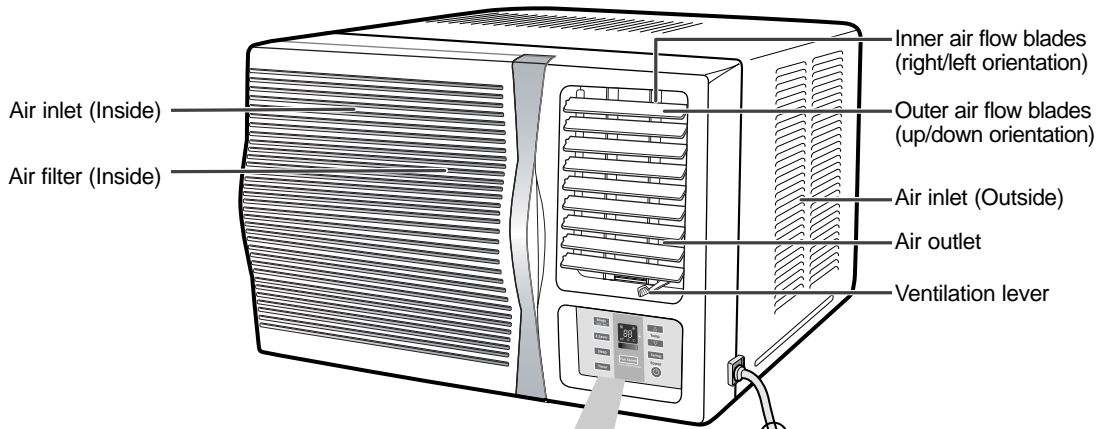

* Power cable connection should be committed to an installation engineer.

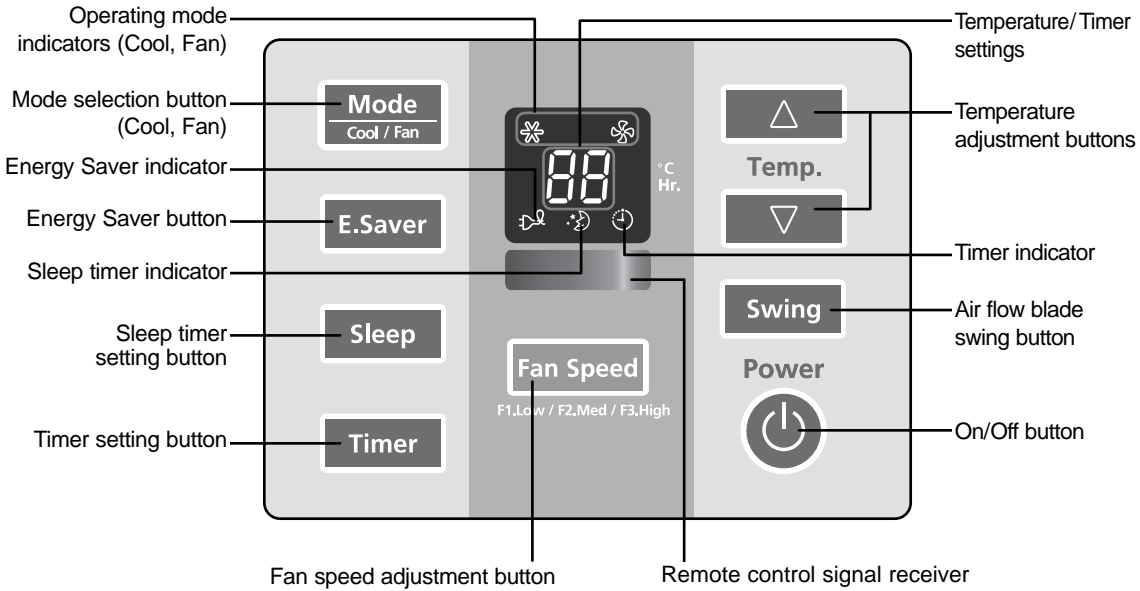

Remote Control - Buttons

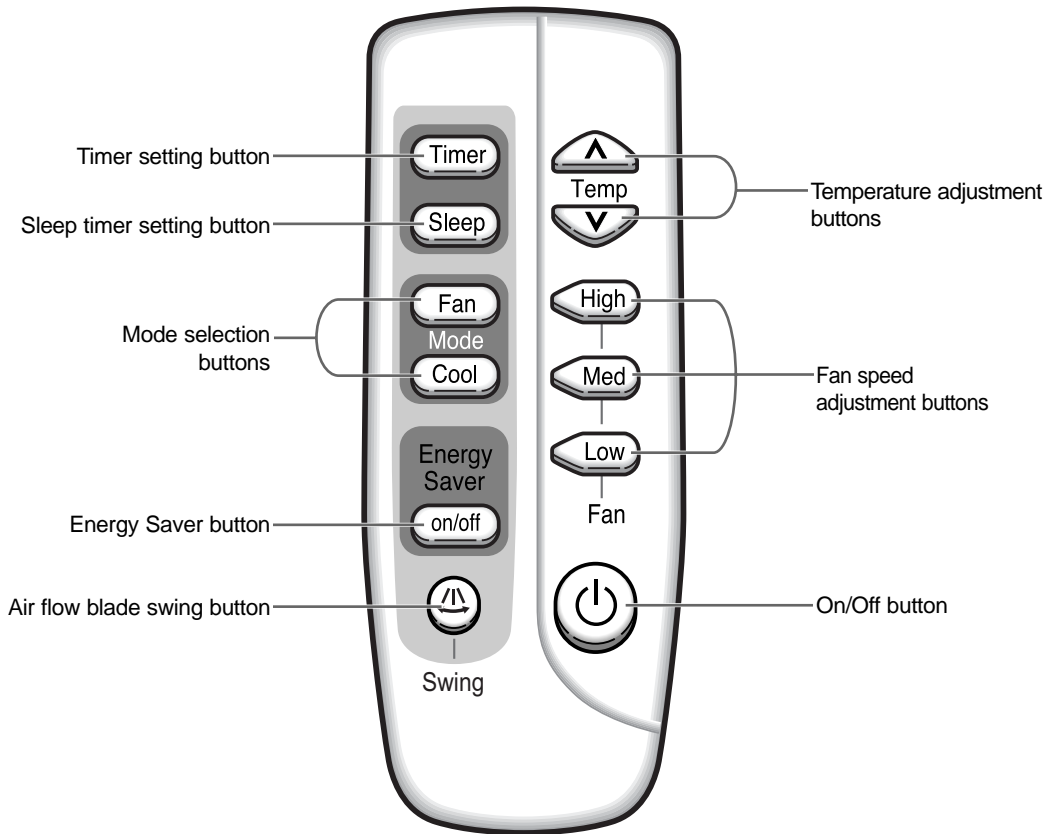

Getting Started

You have just purchased a Samsung window-type room air conditioner which should be installed following your installation manual.

Your Owner's Instructions contain much valuable information on using your air conditioner. Please take the time to read them as they will help you take full advantage of the unit's features.

The booklet is organized as follows.

◆ *The following figures are shown on pages 4 and 5:*

- *Description of Each Component*
- *Remote control (buttons)*

They will help you find the buttons and understand the symbols displayed.

◆ *In the manual, you will find a series of step-by-step procedures for each function available.*

The illustrations in the step-by-step procedures use four different symbols:

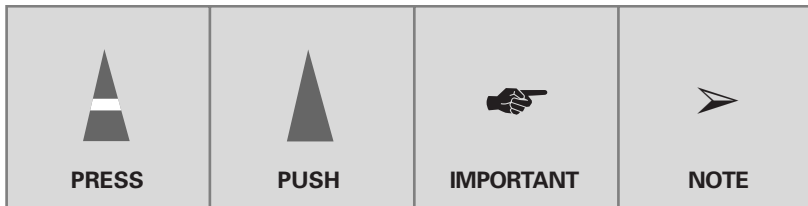

Inserting the Remote Control Batteries

You must insert or replace the remote control batteries when :

- ◆ **You purchase the air conditioner**
- ◆ **The remote control does not work correctly**

-
- ◆ Use two AAA, LR03 1.5V batteries.
 - ◆ Do not use old batteries or different kinds of batteries together.
 - ◆ Batteries may be completely discharged after 12 months, even if they have not actually been used.

1 Push the battery cover on the rear of the remote control with your thumb in the direction of the arrow and remove it.

2 Insert the two batteries, taking care to respect the polarities :
◆ + on the battery with + on the remote control.
◆ - on the battery with - on the remote control.

3 Close the cover by sliding it back until it clicks into place.

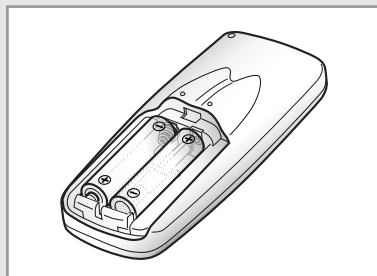
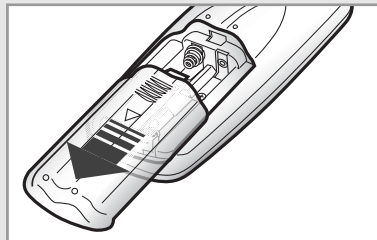

Cooling Your Room

Remote Control



Control Panel

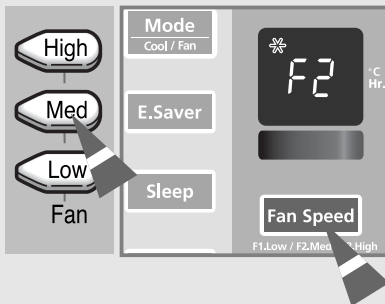
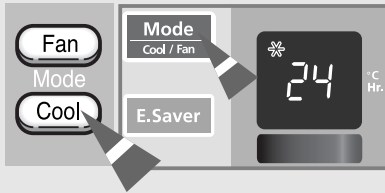
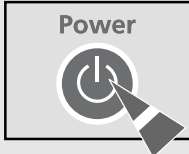

You must select the Cool mode if you wish to lower the temperature in your room. You can also set the Fan speed.

- 1 Press the (On/Off) button.
Result:
 - ◆ The air conditioner starts up in the cool mode(Fan speed will not be changed).
 - ◆ The unit beeps twice.

The air conditioner is fitted with a protection mechanism to prevent the unit from being damaged when it is started immediately after being:

 - ◆ Plugged in
 - ◆ Stopped

It will start up normally after three minutes.

- 2 If the temperature is not displayed on the control panel:
 - ◆ Press the button on the remote control
 - or
 - ◆ Press the button on the unit one or more times until the temperature is displayed.Result:
 - ◆ The unit beeps each time you press the / button.
 - ◆ The air conditioner starts up in the Cool mode.

➤ You can change modes at any time.

- 3 To adjust the temperature, press the or buttons on the remote control or unit one or more times until the desired temperature is displayed.
 The temperature can be set between 18°C and 30°C.
Result:
 - ◆ Each time you press the or buttons:
 - The temperature is adjusted by 1°C and displayed on the control panel
 - The unit beeps
 - ◆ The air conditioner starts cooling, if the room temperature is higher than the selected temperature.
 - ◆ If the room temperature reaches the set temperature, the air conditioner stops cooling, but the fan is still operating.

- 4 To set the fan speed:
 - ◆ Press the , or button on the remote control as desired.
 - or
 - ◆ Press the button on the unit one or more times until the desired Fan speed(F1, F2 or F3) is displayed.

F 1	Low
F 2	Medium
F 3	High

- 5 To control the direction of the air flow, refer to pages 10 and 11.

Ventilating Your Room

If the air in your room is stale, you can ventilate the room using the Fan feature.

- 1 If you wish to discharge stale air, push the ventilation lever on the front of the unit to the right and open position ().

Result: ◆ The air inside the room circulates and stale air is discharged outside.



Otherwise, push the ventilation lever to the left and closed position ().



Result: ◆ The air simply circulates inside the room.

- 2 If necessary, press the  (On/Off) button.

Result: ◆ The air conditioner starts up in the cool mode(Fan speed will not be changed).
◆ The unit beeps twice.





- 3 If the fan speed(F1, F2 or F3) is not displayed on the control panel:



- ◆ Press the  button on the remote control
or
- ◆ Press the  button on the unit one or more times until the fan speed (F1, F2 or F3) is displayed.

Result: ◆ The unit beeps each time you press the  /  button.
◆ The air conditioner starts up in Fan mode.

- ◆ You can change modes at any time.
- ◆ When the air conditioner is in the Fan mode, the temperature cannot be set or displayed.

- 4 To set the fan speed:

- ◆ Press the ,  or  button on the remote control as desired.
or
- ◆ Press the  button on the unit one or more times until the desired fan speed(F1, F2 or F3) is displayed.

	Low
	Medium
	High

- 5 To control the direction of the air flow, refer to pages 10 and 11.

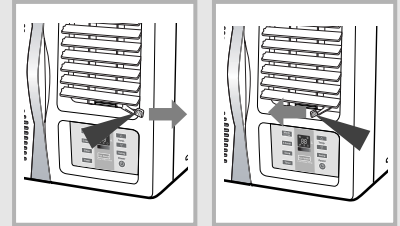

Remote Control





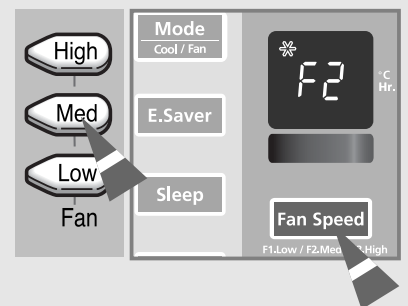
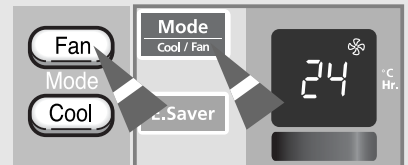
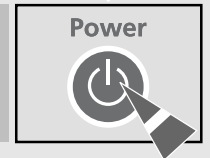



Control Panel

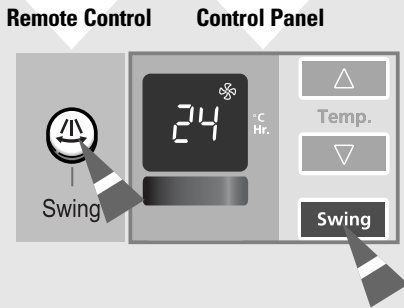

Adjusting the Air Flow Direction Horizontally

Depending on the position of the unit in your room, you can adjust the orientation of the inner air flow blades on the right-hand side of the unit, thus increasing the efficiency of the air conditioner.



- 1 Press the  button on the remote control or  button on the unit.
Result: The inner blades swing automatically left and right.
 - In the Energy Saving mode, the blades may stop when the compressor is off. For details on the Energy Saving mode, refer to page 15.
- 2 To stop the blades moving left and right, press the  /  button again.
 - To stop the blades in a specific position and orient the air flow in the corresponding direction, simply press the  /  button when the blades are in the desired position.

Adjusting the Air Flow Direction Vertically

The outer air flow blades can be adjusted to control the vertical air flow direction.

RECOMMENDATION	When...	Adjust the blades to face...
	Cooling	Upwards.

Adjust the air flow blades to the desired position, by pushing them upwards or downwards.



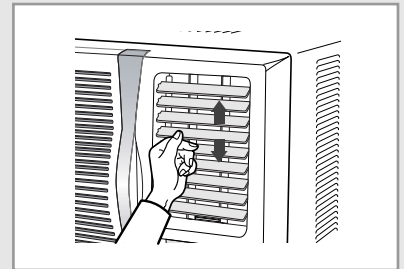

- If you orient the air flow blades downwards and the unit operates in the Cool mode for long periods of time, dew may:
- ◆ Form on the surface of the blades
 - ◆ Drip from the blades

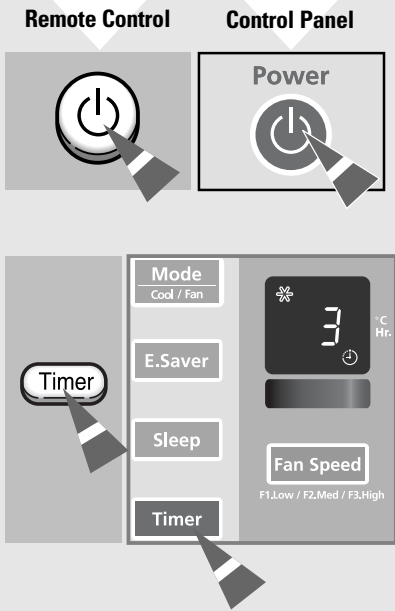

Setting the On Timer



The On Timer enables you to switch on the air conditioner automatically after a given time. You can select the On timer only when the air conditioner is off. You can select the On timer only when the air conditioner operates in the Cool mode.

- 1 Check that the air conditioner has been switched off; if necessary, press the  (On/Off) button.
 - 2 Set the operating time by pressing the  button on the remote control or  button on the unit one or more times until the desired time is displayed. The operating time can be set between 1 and 24 hours.
Result:
 - ◆ Each time you press the  button:
 - The time is adjusted by 1 hour and displayed on the control panel
 - The unit beeps
 - ◆ The operating time is displayed and decreases automatically to indicate the remaining time.
 - ◆ The air conditioner starts up in the Cool mode automatically when the operating time reaches zero.
- You can select the fan speed, temperature, air flow direction and Energy saving mode after setting the On timer and Off timer mode. However, when you change the mode, the On timer and Off timer mode is canceled.

To Cancel the On Timer

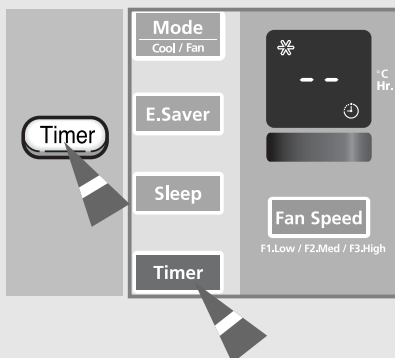



To cancel the timer, press:

- ◆ Timer on the remote control or unit one or more times until "--" is displayed.
or
- ◆ The  (On/Off) button on the remote control or unit. (The air conditioner operates in the cool mode.)

Setting the Off Timer

The Off Timer enables you to switch off the air conditioner automatically after a given time. You can select the Off timer only when the air conditioner is on. You can select the Off timer only when the air conditioner operates in the Cool mode.

- 1 Check that the air conditioner has been switched on; if necessary, press the  (On/Off) button.

- 2 Set the operating time by pressing the  button on the remote control or  button on the unit one or more times until the desired time is displayed. The operating time can be set between 1 and 24 hours.

- Result:**
- ◆ Each time you press the  button:
 - The time is adjusted by 1 hour and displayed on the control panel
 - The unit beeps
 - ◆ The operating time is displayed and decreases automatically to indicate the remaining time.
 - ◆ The air conditioner switches off automatically when the operating time reaches zero.

- You can select the fan speed, temperature, air flow direction and Energy saving mode after setting the On timer and Off timer mode. However, when you change the mode, the On timer and Off timer mode is canceled.

Remote Control



Control Panel

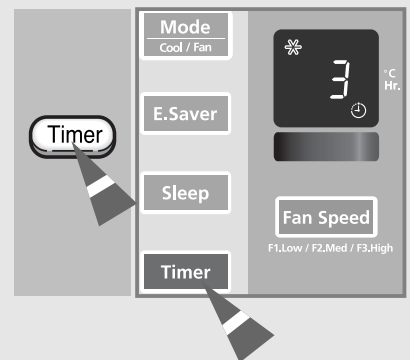
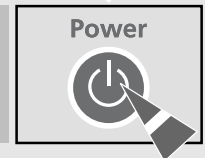

To Cancel the Off Timer

To cancel the timer, press:

- ◆ Timer on the remote control or unit one or more times until "--" is displayed.
- or
- ◆ The  (On/Off) button on the remote control or unit.

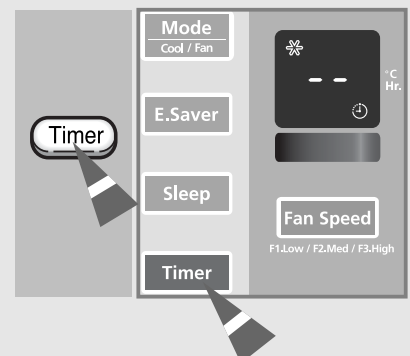

Setting the Sleep Timer

The Sleep Timer can be used when you are cooling your room to switch the air conditioner off automatically after 8 hours.

➤ *If you wish to switch the unit off at a specific time, refer to page 13.*

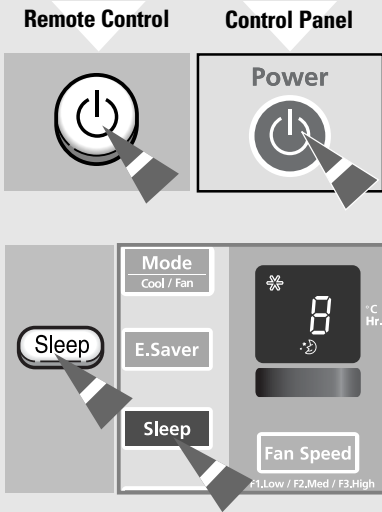

- 1 Make sure that you have selected the Cool mode.

- 2 Press the **Sleep** button on the remote control
or
Press the **Sleep** button on the unit.

Result:

- ◆ Each time you press a button, the unit beeps.
- ◆ The “8” will be displayed.
- ◆ The remaining time is displayed and decreased by 1 hour automatically to indicate the remaining time.
- ◆ The air conditioner will be controlled as illustration below.

Cooling When the temperature has been increased by 1°C (after 1 hour), it is maintained for 7 hours.

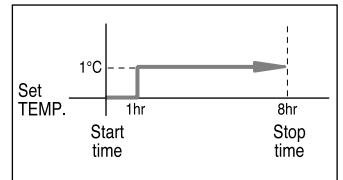

To Cancel the Sleep Timer

To cancel the timer, press:

- ◆ **Sleep** button on the remote control.
- or
- ◆ **Sleep** button on the unit.



Result:

- ◆ The unit beeps.
- ◆ The SLEEP indicator is no longer displayed.
- ◆ The air conditioner operates in the mode selected last.

➤ If you select the Energy Saving mode in the Sleep Timer mode, the Sleep Timer will be cancelled and the air conditioner will start up in the Energy Saving mode.

Selecting Energy Saving Mode



If you wish to save energy when using your air conditioner, select the Energy Saving mode.

- 1 To select the energy saving mode, press the  button on the remote control or  button on the unit one or more times until the Energy Saver indicator lights up.

Result:

- ◆ The fan and compressor cycle on and off together.
- ◆ The fan will continue to run for a short time after the compressor cycles off.

- If you would like the air conditioner to run in Fan mode, do not press the  button. You cannot use the Fan mode in the energy saving mode.

- 2 To stop the energy saving mode, press the  button on the remote control or  button on the unit again.

Result: The fan runs at all times, while the compressor cycles on and off.

- If you select the Sleep Timer in the Energy Saving mode, the Energy Saving will be cancelled and the air conditioner will start up in the Sleep Timer mode.

Remote Control

Control Panel

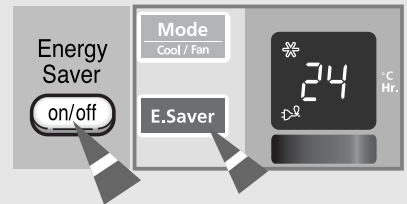
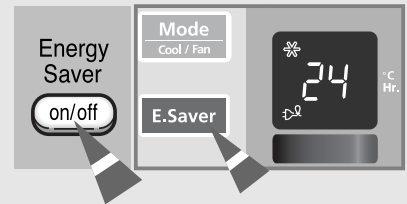

Operating Recommendation

Here is a recommendation that you should follow when using your air conditioner.

Topic	Recommendation
Power failure	If a power failure occurs when the air conditioner is operating, the unit is switched off. When the power returns, the air conditioner starts up again automatically.

Temperature and Humidity Ranges

The following table indicates the temperature and humidity ranges within which the air conditioner can be used.

Mode	Indoor Temperature	Outdoor Temperature	Indoor Humidity
Cooling	21°C to 32°C approx.	21°C to 54°C approx.	80% or less

If the air conditioner is used at...	Then...
Higher temperature	The automatic protection feature may be triggered and the air conditioner stopped.
Lower temperature	A water leakage or some other malfunction may happen if the heat exchanger freezes.
Higher humidity levels	Water may condense on and drip from the surface of the unit if it is used for long periods.

Cleaning Your Air Conditioner

Be sure to clean the air filter periodically to maintain the air conditioner in the best condition for a long period of time.

☞ **When cleaning the air conditioner, turn it off and pull out the power plug.**

1 Hold the air filter handle, slightly pull it to the left side and open the front grille.

➤ The removal of the front grille makes it easier to clean the air conditioner.

CAUTION

Removal and Reassembly of the Front Grille

For user's safety, a safety clip has been installed in the front grille.

1 Grasp the lower part of the front grille and the air filter handle, then open the grille. (The open angle of front grille has not to be exceeded 90 degree)

2 Lift up the front grille (10mm~15mm) and remove it from front panel.

3 Reassembling of front grille should be done in reverse order of disassembly.

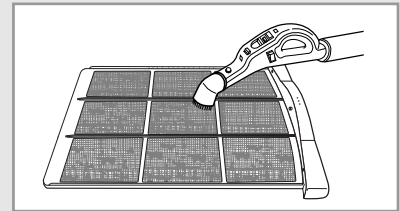
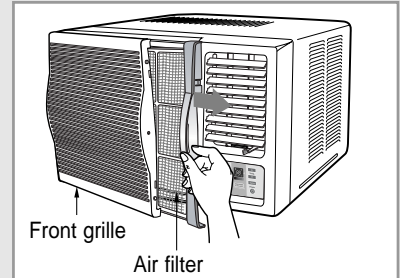
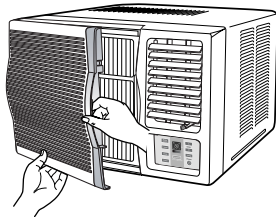

2 Pull the air filter to the right side.

3 Remove all dust on the air filter with a vacuum cleaner or brush.

4 When you have finished, insert the air filter back into its original position.

5 Wipe the surface of the unit with a neutral detergent and then wipe it again with dry cloth.
(Be sure not to use benzene, solvent or other chemical products.)

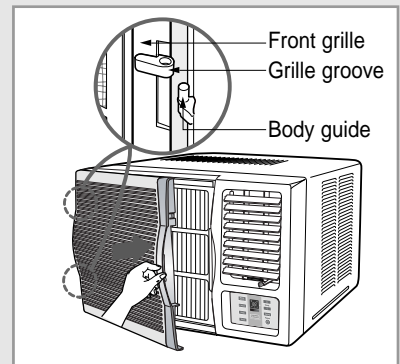



If you...	Then...
Will not use the air conditioner for a long period of time	<ul style="list-style-type: none">◆ Set the fan going for a few hours to dry the inside of the air conditioner thoroughly.◆ Switch the air conditioner off and unplug it from the wall socket.◆ Clean the filter and outer surfaces.

Have not used the air conditioner for a long period of time	Set the fan going for a few hours to dry the inside of the air conditioner thoroughly.
---	--

Solving Common Problems

Before contacting an authorized service center, perform the following simple checks. They may save you the time and expense of an unnecessary call.

Problem	Explanation / Solution
The air conditioner does not operate at all	<ul style="list-style-type: none">◆ Check that the circuit breaker used for the air conditioner has not been triggered.◆ Check that the power cable is plugged into a wall socket and the socket is switched on, if necessary.◆ Check that the temperature indicator on the unit is lit; if necessary, press the  (On/Off) button on the remote control or unit.
The air conditioner does not operate with the remote control	<ul style="list-style-type: none">◆ Check that there are no obstacles between you and the unit.◆ Replace the remote control batteries if necessary.◆ Check that you are close enough to the unit (seven metres/yards or less).
No beep is heard when you press the  (On/Off) button on the remote control	<ul style="list-style-type: none">◆ Check that you are pointing the remote control at the remote control sensor on the unit.◆ Replace the remote control batteries if necessary.
The air conditioner does not cool	<ul style="list-style-type: none">◆ Check that the correct operating mode has been selected(Cool).◆ The room temperature may be too low.◆ Dust may be blocking the air filter; refer to page 17 for cleaning instructions.◆ Check that there is no obstacle blocking the air flow into or out of the unit.
The timer is not correctly triggered	<ul style="list-style-type: none">◆ Check that the timer has been programmed correctly; refer to pages 12~14.
Odour is permeating the room during air conditioning	<ul style="list-style-type: none">◆ Ventilate the room.

Technical Specifications

Design and specifications are subject to change without notice.

Model	Power Supply
AWT18QBHDA	200-220V~, 50Hz

Installation

Before installation, be sure to check the installation area or the air conditioner, and drain hose.

Checkpoints prior to installation

- 1 Check the cabinet and front grille of the unit for any harmful defects such as scratches.
- 2 Be sure to check the power supply.
- Refer to the specifications on the label attached to the unit.

Installation Conditions

- 1 As the unit is heavy, the wall or window of the installation area should have sufficient strength and durability for operation of the air conditioner, and for prevention of any vibration or noise.
If it is weak, reinforcement work should be performed separately.
- 2 It is advisable to install the air conditioner in the north or west side to prevent the effect of direct sunlight.
When installing it in the south or east side due to unavoidable circumstances, it is advisable to install the sunshade to prevent the direct sunlight.
In this case, take care not to cause any hindrance to the flow of outside air.
- 3 When installing the air conditioner, be sure to obtain sufficient space on the rear side of the unit for smooth flow of air.
When operating the air conditioner in closed areas such as inner building with cooling operation, and result in trouble with the unit.
See the illustration below.

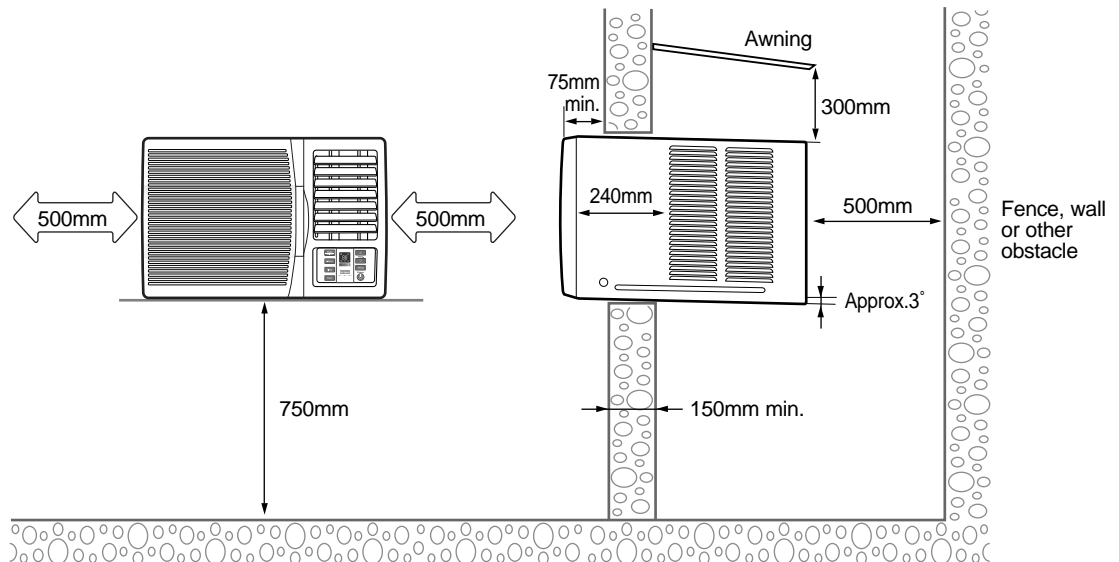

- ◆ If the wall is greater than 150mm thick, cut the wall back on a 45° angle if possible.

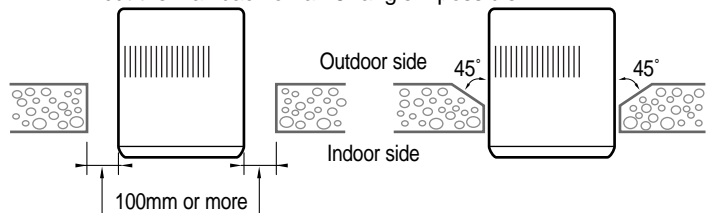

Installation of the Drain Tube

Fix the drain tube as shown in the figure.

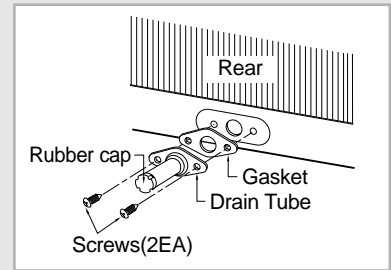

Installation of the Drain Pan

The procedure for installing the drain pan should be determined by the condition of the installing area.

◆ **In the case of an area where the drain pan can not be directly installed on the rear side of the unit after installing the air conditioner.**

Example: High storage

- 1 Open the front grille ; refer to page 17.
- 2 Remove the front panel.
 - 2-1 Press both sides of the cabinet in the direction of the arrow as shown in the figure.
 - 2-2 Pull the lower part of the front panel slightly forward. (below three inches)
 - 2-3 Lift the front panel upward.

 Applying excessive force to remove the front panel may cause damage to the tab ; be sure not to use excessive force.

- 3 Remove two screws on the lower, right and left sides of the unit.
- 4 Remove the chassis from the cabinet.
- 5 Remove the rubber cap inserted into the basepan.
- 6 Fix the drain pan as shown in the figure, and then connect the drain hose. (You can use any commercially-available drain hose.)
- 7 Install the cabinet at the specified area after installing the drain pan, and then re-assemble it in the original condition.
 - Tighten the supplied screw on the lower part of front panel to secure the front panel.

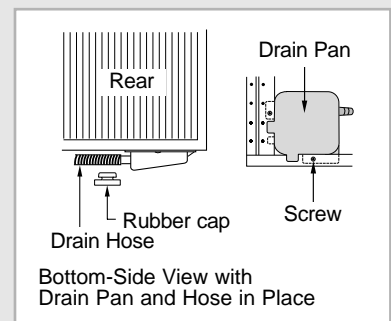
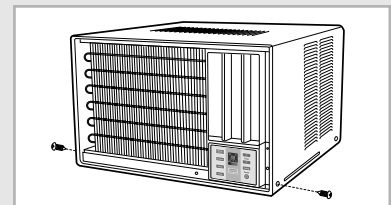
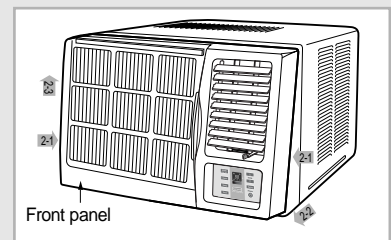

◆ **In the case of an area where the drain pan can be directly installed on the rear side of the unit after installing the air conditioner.**

- 1 Follow steps 5 and 6 only

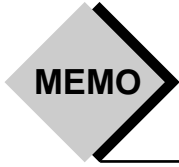

A series of horizontal dotted lines for writing, starting from the right side of the "MEMO" label and extending across the page.

A series of 20 horizontal dotted lines for writing.

THIS AIR CONDITIONER IS MANUFACTURED BY:

