

Owner's Instructions

Before operating, please read this manual thoroughly, and retain it for future reference.

Register your product at www.samsung.com/global/register

Control Panel (depending on the model)

➤ The actual configuration of your TV may be different, depending on your model.

Front (or Side) Panel

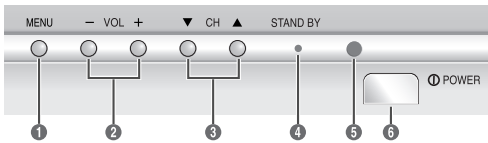

- ❶ On-screen menu display
- ❷ Volume adjustment
- ❸ Channel selection
- ❹ Standby indicator
- ❺ Remote control sensor
- ❻ Power on/off

- ◆ You can use the ❸ buttons to switch the TV on when it is in standby mode depending on the model.
- ◆ The ❷ and ❸ buttons also have the same function as the ◀▶/▼/▲ buttons on the remote control.
- ◆ If the remote control no longer works or you have misplaced it, you can use the controls on the panel of the television.

Connection Panel (depending on the model)

➤ The actual configuration of your TV may be different, depending on your model.

Rear Panel

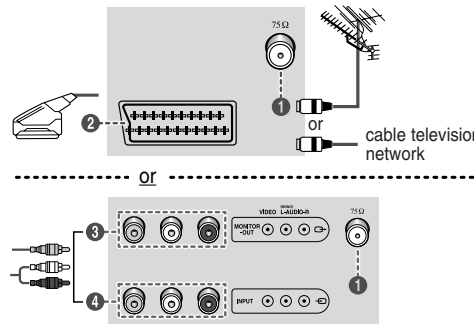

⚠ Whenever you connect an audio or video system to your television, ensure that all elements are switched off. Please be sure to match the color coded input terminals and cable jacks.

Connecting to an Aerial or Cable Television Network

Connect the aerial or network input cable to the ❶ (75 Ω coaxial socket).
To view television channels correctly, a signal must be received by the set from one of the sources: an outdoor aerial, cable television network, or satellite network.
If you are using an indoor aerial, you may need to adjust it when tuning your television until you obtain a picture that is both sharp and clear.

Connecting to the SCART Input/Output

The SCART ❷ connector is used for equipment, such as a VCR, DVD, decoder, satellite receiver, video game device, or video disc player.

continued...

Connecting to the RCA Input

The RCA ❹ connectors are used for equipment, such as a VCR, DVD, decoder, satellite receiver, video game device, or video disc player. (When using the mono equipment, connect to the **AUDIO-L** input connector.)

Connecting to the RCA Output

The RCA ❸ connectors are used for equipment, such as a recording VCR or audio system.

Front (or Side) Panel

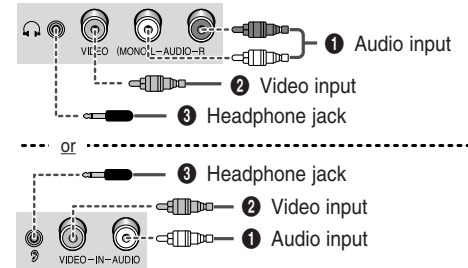

⚠ Please be sure to match the color coded input terminals and cable jacks.

Connecting to the RCA Input

The ❶ (**AUDIO-L/R**) and ❷ (**VIDEO**) connectors are used for equipment, such as a camcorder, video disc player, or video game device.

Connecting Headphones

The ❸ (headphone) jack is used for watching a television programme without disturbing the other people in the room. Prolonged use of headphones at a high volume may damage your hearing.

➤ When both the front (or side) AV and rear connectors are connected to external equipment, the front (or side) AV receives priority.

Remote Control (depending on the model)

- Operation of remote control may be affected by bright artificial light near to the TV.

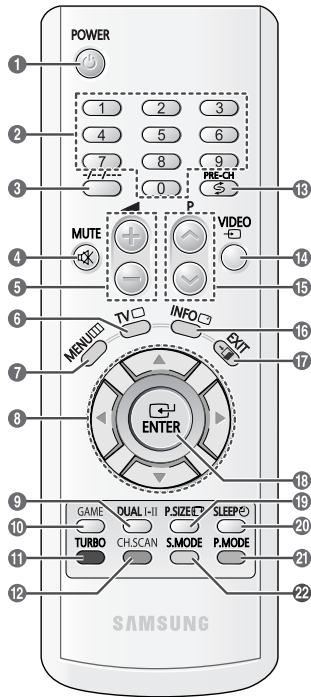

- POWER**
Used to switch the TV on and off.
- Numeric buttons**
Used to select channels directly.
- /--/---**
Used to select a channel numbered ten or over. Press this button, then “---” symbol is displayed. Enter the three-digit channel number.
- MUTE**
Used to switch the sound off temporarily. To turn the sound back on, press the **MUTE**, **+**, or **-** button.
- ▲/▼/◀/▶**
Used to increase or decrease the volume.
- TV**
Used to return to the TV mode when it is in external input mode.

- MENU**
Used to display the on-screen menu or return to the previous menu.
- ▲/▼/◀/▶**
Used to control the cursor in the menu.
- DUAL I-II (option)**
Used to select the sound mode.
- GAME (option)**
Used to enjoy the game programmed in the TV.
- TURBO (option)**
Used to select the turbo sound option.
- CH.SCAN**
Used to view every memorized channel in order.
- PRE-CH**
Used to switch repeatedly between the last two channels displayed.
- VIDEO**
Used to display all of the available video sources.
- P**
Used to display the next or previous stored channel.
- INFO**
Used to view the channel information and setting status you selected.
- EXIT**
Used to exit from any display or return to normal viewing.
- ENTER**
While using the on-screen menus, press the **ENTER** button to activate (or change) a particular item.
- P.SIZE**
Used to change the screen size.
- SLEEP**
Used to select a preset time interval for automatic shut off.
- P.MODE**
Used to select the picture effect.
- S.MODE (option)**
Used to select the sound effect.

Installing Batteries

- Remove the cover. Install two AAA size batteries, then replace the cover. When the remote control does not operate normally, check that the “+” and “-” ends of the batteries are inserted correctly or the batteries are drained.
- Do not mix battery types, i.e. alkaline and manganese.

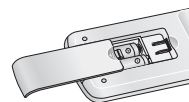

Switching the Television On and Off

The mains lead is attached to the rear of the television.

- Plug the mains lead into an appropriate socket.
 - The main voltage is indicated on the rear of the television and the frequency is 50 or 60Hz.
- Press the **⏻** button (On/Off) on the front (or side) of the television.
- Press the **POWER** button on the remote control to switch the television on. The programme that you were watching last is re-selected automatically. If you have not yet stored any channels, no clear picture appears. Refer to “Channel - Auto Store” on page 3 or “Channel - Manual Store” on page 4.
 - If the television is initially powered on, several basic customer settings proceed automatically. Refer to “Setup - Plug & Play” on page 3.
- To switch the television off, press the **⏻** button (On/Off) on the front (or side) of the television.

Placing the Television in Standby Mode

The television can be placed in standby mode, in order to reduce power consumption and wear of the cathode ray tube. Standby mode can be useful when you wish to interrupt viewing temporarily (during a meal, for example).

- Press the **POWER** button on the remote control while viewing. The television is in standby mode.
 - To switch the television back on, simply press it again.
- Do not leave the television in standby mode for long periods of time (when you are away on holiday, for example). Turn the television off by pressing the **⏻** button (On/Off) on the front (or side) of the television. It is best to unplug the set from the mains and aerial.

Viewing the Menus



- 1 Press the **MENU** button.
The main menu is displayed on the screen. Its left side has five icons: **INPUT**, **PICTURE**, **SOUND**, **CHANNEL**, and **SETUP**.
- 2 Press the **▲** or **▼** button to select one of the icons. Press the **ENTER** button to access the icon's sub-menu.
- 3 Press the **▲** or **▼** button to move to items in the menu. Press the **ENTER** button to enter items in the menu.
- 4 Press the **▲/▼/◀/▶** button to change the selected items. Press the **MENU** button to return to the previous menu.
- 5 Press the **EXIT** button to exit from the menu.

Setup - Plug & Play

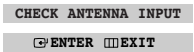
When the television is initially powered on, several basic customer settings proceed automatically and subsequently. The following settings are available.

- 1 If the television is in standby mode, press the **POWER** button on the remote control. The **PLUG & PLAY** is displayed. It flickers for a little while, and then **LANGUAGE** menu is displayed.
 
- 2 Select the appropriated language by pressing the **▲** or **▼** button. Press the **ENTER** button. The **CHECK ANTENNA INPUT** is displayed.
 
 - If any language is not selected, the language menu will disappear about 30 seconds later.

continued...

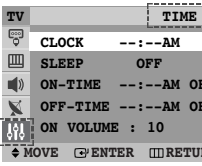
- 3 Make sure that the antenna is connected to the television (refer to page 1). Press the **ENTER** button. The **SEARCH** menu is displayed.
 
- 4 Press the **ENTER** button to search the channels. To stop the search, press the **ENTER** button. When the channel searching has finished, the **TIME** menu is displayed with **CLOCK** selected.
 
- 5 Press the **◀** or **▶** button to move to the hour or minute. Set the hour or minute by pressing the **▲** or **▼** button.
 
- 6 When you have finished, press the **MENU** button. The **ENJOY YOUR VIEWING** is displayed, and then the channel which has been stored will be activated.

Re-setting the Plug & Play

Method: **MENU** → **▲/▼**
(SETUP) → **ENTER** → **▲/▼**
(PLUG & PLAY) → **ENTER**

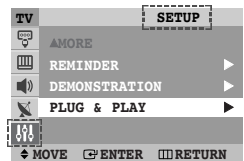

Input - Source List (depending on the model)

You can switch between viewing signal from connected equipment, such as a VCR, DVD, set-top box, and the TV source (broadcast or cable).

- You can change the required external source simply by pressing the **VIDEO** button on the remote control. It might take a short period of time for pictures to be switched. To return to the TV mode, press the **TV** button on the remote control.

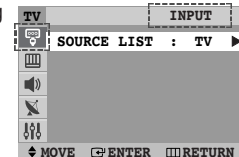

Channel - Auto Store

You can scan for the frequency ranges available to you (and availability depends on your country). Automatically allocated programme numbers may not correspond to actual or desired programme numbers. However you can sort numbers manually and clear any channels you do not wish to watch.

Channels are sorted and stored in the order which reflects their position in the frequency range (with lowest first and highest last). The programme originally selected is then displayed.

- To stop the search before it has finished, press the **MENU** button.

When finished, the **Sort** menu is displayed. To sort the stored channels into the desired numerical order, refer to "Channel - Sort". To exit without sorting, press the **EXIT** button.

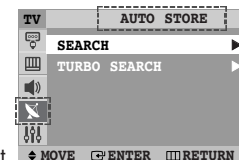

Channel - Manual Store

You can store channels, including those received via cable networks. When storing channels manually, you can choose:

- Whether or not to store each of the channels found
- The programme number of each stored channel which you wish to identify

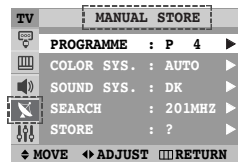

- ◆ **PROGRAMME** (Programme number to be assigned to a channel)
- ◆ **COLOR SYS.:** AUTO/PAL/N3.58/N4.43
- ◆ **SOUND SYS.:** BG/DK/I/MN
- ◆ **SEARCH:** The tuner scans the frequency range until the first channel or the channel that you selected is received on the screen.
- ◆ **STORE** (When you store the channel and associated programme number)

- If there is no sound or abnormal sound, re-select the sound standard required.

Channel - Add/Delete

You can exclude channels you have chosen from the channels you scanned. When you scan through the stored channels, those you have chosen to skip are not displayed. All of the channels that you did not specifically choose to skip are displayed during scanning.

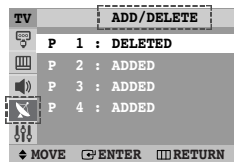

Channel - Sort

This operation allows you to change the programme numbers of stored channels. This operation may be necessary after using auto store.

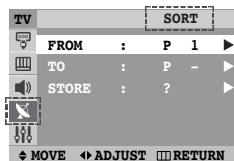

- ◆ **From:** Channel number to be changed.
- ◆ **To:** New channel number to be identified.
- ◆ **Store:** Confirmation the exchange of channel numbers.

Setup - Time

- ◆ **CLOCK**
You can set the television clock so that the current time is displayed when pressing the **INFO** button on the remote control. You must also set the time if you wish to use the automatic on or off timers.
➤ When pressing the **⏸** button (On/Off) on the front (or side) of the television, the clock setting will be reset.

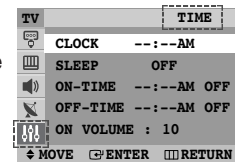

- ◆ **SLEEP**
You can select a time period of between 30 and 180 minutes after which the television automatically switches to standby mode.
➤ You can select these options simply by pressing the **SLEEP** button on the remote control. If the sleep timer is not yet set, **OFF** is displayed. If it is already set, the remaining time before which the television switches to standby mode is displayed.

- ◆ **ON-TIME / OFF-TIME**
You can set the On/Off timers so that the television will switch on or off automatically at the time you select.
☞ You must set the clock first.

- ◆ **ON VOLUME**
The preferred volume can be set for when the timer automatically turns on the television.

- ☞ **Auto Power Off**
When you set the timer "On", the television will eventually turn off, if no controls are operated for 3 hours after the TV was turned on by timer. This function is only available in timer "On" mode and prevents overheating or leakages, which may occur if a TV is on for too long (when you are on vacation, for example).

Setup - Child Lock

This feature allows you to prevent unauthorized users, such as children, from watching unsuitable programmes by muting out video and audio. Child Lock cannot be released using front (or side) panel buttons. Only remote control can release the Child Lock setting, so keep the remote control away from children.

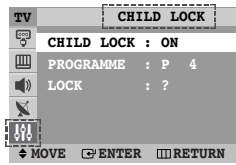

◆ CHILD LOCK: ON/OFF

If you want to unlock a channel, set to **Off**.

◆ PROGRAMME: Channel number to be locked.

◆ LOCK: When press the ENTER button, the LOCKED is displayed.

- If any channel is locked, you can not access to the **CHANNEL** and **CHILD LOCK** menu by using the control buttons on the TV panel (the **NOT AVAILABLE** is displayed in the **CHILD LOCK** menu). You can access by using the remote control only.

Setup - Reminder

This feature facilitates you for displaying a message input on the screen at the desired time set by you.

◆ REMINDER: ON/OFF

If you do not want to display a message, set to **OFF**.

◆ MESSAGE (A-Z / 0-9 / & / -)

Message of maximum 30 characters can be entered.

◆ DISP.TIME

It is the time at which the message will be displayed on the screen.

◆ ERASE

You can delete the entire written message.

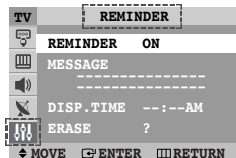

Setup - Language / Blue Screen / Demonstration

◆ LANGUAGE

It is variable depending on the model. When you start using the television for the first time, you must select the language which will be used for displaying menus and indications.

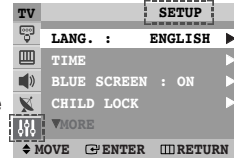

◆ BLUE SCREEN

If no signal is being received or the signal is very weak, a blue screen automatically replaces the noisy picture background. If you wish to continue viewing the poor picture, you must set the **BLUE SCREEN** to **OFF**.



◆ DEMONSTRATION

To become familiar with the various menus provided by the television, you can view the in built demonstration. Each of the menu options is displayed in turn. To exit from the demonstration, press the **EXIT** button.

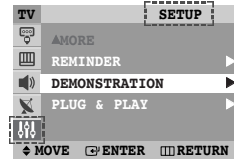

Picture - Mode / Custom / Color Tone / Size

◆ MODE: DYNAMIC/STANDARD/MOVIE/CUSTOM

You can select the type of picture which best corresponds to your viewing requirements.

- You can select these options simply by pressing the **P.MODE** button on the remote control.

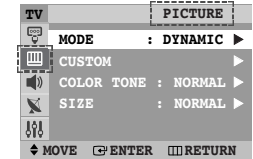

◆ CUSTOM: CONTRAST/BRIGHTNESS/SHARPNESS/COLOR/TINT(NTSC only)

The television has several settings which allow you to control the picture quality.

- If you make any changes to these settings, the picture mode is automatically switched to **CUSTOM**.

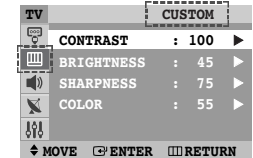

◆ COLOR TONE: WARM2/WARM1/NORMAL/COOL1/COOL2

◆ SIZE: NORMAL/ZOOM

You can select the picture size which best corresponds to your viewing requirements. It is variable depending on the model.

- You can change the picture size simply by pressing the **P.SIZE** button on the remote control.

Sound - Volume

You can adjust the volume of the TV.

- You can increase or decrease the volume simply by pressing the **▲/▼** button on the remote control.

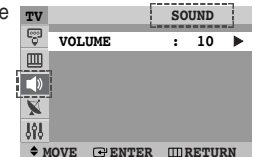

Troubleshooting

Before contacting the Samsung after-sales service, perform the following simple checks. If you cannot solve the problem using the instructions below, note the model and serial number of the television and contact your local dealer.

No sound or picture

- ◆ Check that the mains lead has been connected to a wall socket.
- ◆ Check that you have pressed the  button (On/Off) and the **POWER** button.
- ◆ Check the picture contrast and brightness settings.
- ◆ Check the volume.

Normal picture but no sound

- ◆ Check the volume.
- ◆ Check whether the volume **MUTE** button on the remote control has been pressed.

No picture or black and white picture

- ◆ Adjust the color settings.
- ◆ Check that the broadcast system selected is correct.

Sound and picture interference

- ◆ Try to identify the electrical appliance that is affecting the television, then move it further away.
- ◆ Plug the television into a different mains socket.

Blurred or snowy picture, distorted sound

- ◆ Check the direction, location and connections of your aerial.
This interference often occurs due to the use of an indoor aerial.

Remote control malfunctions

- ◆ Replace the remote control batteries.
- ◆ Clean the upper edge of the remote control (transmission window).
- ◆ Check that the “+” and “-” ends of the batteries are inserted correctly.
- ◆ Check that the batteries are drained.

OSD Map

* : It is variable depending on the model.



INPUT

– SOURCE LIST *



PICTURE

– MODE

– DYNAMIC / STANDARD / MOVIE / CUSTOM

– CUSTOM

– CONTRAST / BRIGHTNESS / SHARPNESS / COLOR / TINT (NTSC ONLY)

– COLOR TONE

– WARM2 / WARM1 / NORMAL / COOL1 / COOL2

– SIZE *

– NORMAL / ZOOM



SOUND

– VOLUME



CHANNEL

– AUTO STORE

– SEARCH

– MANUAL STORE

– TURBO SEARCH

– PROGRAMME

– COLOR SYS. * – AUTO / PAL / N3.58 / N4.43

– SOUND SYS. * – BG / DK / I / MN

– SEARCH

– STORE

– ADD/DELETE

– ADDED / DELETE

– SORT

– FROM

– TO

– STORE



SETUP

– LANGUAGE *

– ENGLISH / MALAY / INDONESIAN / VIETNAMESE / THAI

– TIME

– CLOCK

– SLEEP

– ON-TIME

– OFF-TIME

– ON-VOLUME

– BLUE SCREEN

– OFF / ON

– CHILD LOCK

– CHILD LOCK – OFF / ON

– PROGRAMME

– LOCK

– REMINDER

– REMINDER – OFF / ON

– MESSAGE

– DISP.TIME

– ERASE

– DEMONSTRATION

– PLUG & PLAY