



# COLOUR TELEVISION

## Owner's Instructions

Before operating the unit,  
please read this manual thoroughly,  
and retain it for future reference.

**REMOTE CONTROL  
ON-SCREEN MENUS  
ENJOY GAME**

## Safety Instructions

ENG

The following illustrations represent the precautions to be taken when using and moving your television.

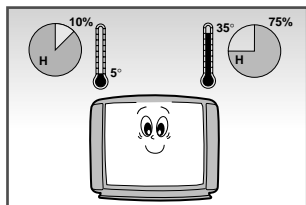

Do NOT expose the television to extreme temperature conditions (below 5°C and above 35°C) or to extreme humidity conditions (less than 10% and more than 75%).

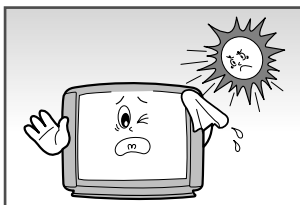

Do NOT expose the television to direct sunlight.

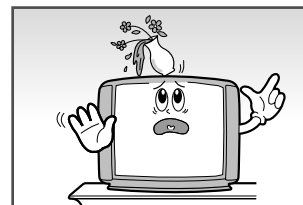

Do NOT expose the television to any liquids.

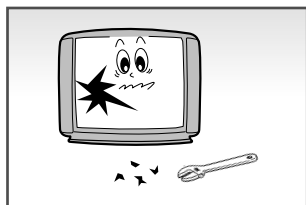

If the television is broken, do not try to repair it yourself. Contact qualified service personnel.

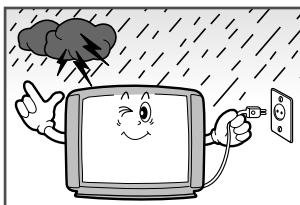

During a storm conditions (especially when there is lightning) unplug the television from the mains socket and aerial.

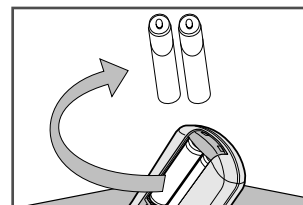

If the remote control is not used for a long period of time, remove the batteries and store it in a cool, dry place.

**THIS DEVICE IS NOT FOR USE IN INDUSTRIAL ENVIRONMENTS**

## Caution

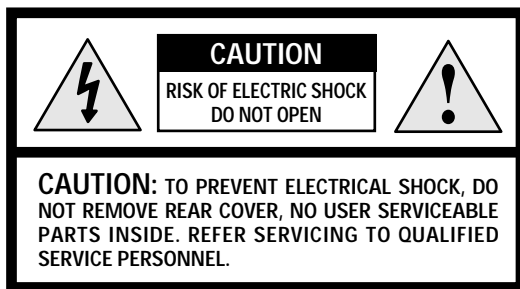

**WARNING:** TO PREVENT DAMAGE WHICH MAY RESULT IN FIRE OR SHOCK HAZARD. DO NOT EXPOSE THIS APPLIANCE TO RAIN OR MOISTURE.



The main voltage is indicated on the rear of the TV set and the frequency is 50 or 60Hz.

The lightning flash and arrow head within the triangle is a warning sign alerting you of "dangerous voltage" inside the product.



The exclamation point within the triangle is a warning sign alerting you of important instructions accompanying the product.



Mode	System
CZ	PAL-B/G, D/K, I, SECAM-B/G,D/K, I, NTSC4.43MHz
CW	PAL-B/G, D/K, I, SECAM-B/G,D/K, I, L/L', NTSC4.43MHz
CS	PAL-B/G, D/K, I, SECAM-B/G,D/K, I, NTSC4.43/3.58MHz

# Contents

ENG

◆ PREPARING YOUR TELEVISION	
■ Safety Instructions .....	2
■ Caution .....	2
■ Front Control Panel .....	4
■ Connection Panels .....	5
■ Infrared Remote Control .....	6
■ Inserting the Batteries in the Remote Control.....	7
■ Connecting the Aerial (or Cable Television Network).....	7
■ Switching Your Television On and Off.....	8
■ Placing Your Television in Standby mode.....	9
■ Plug & Play Feature.....	10
■ Viewing the Demonstration.....	11
■ Choosing Your Language.....	12
◆ SETTING UP THE CHANNELS	
■ Storing the Channels Automatically.....	13
■ Storing the Channels Manually.....	14
■ Skipping Unwanted Channels .....	16
■ Fine tuning Channel Reception .....	17
■ Sorting the Stored Channels .....	18
■ Changing Channels .....	19
■ Pre Channel .....	19
■ Channel Scan .....	19
■ Selecting a Channel Numbered Ten or Over .....	19
◆ USING THE TELEVISION	
■ Changing the Picture Standard .....	20
■ Adjusting the Picture Settings .....	21
■ Selecting the Picture Format .....	21
■ Activation/Deactivation the Digital Noise Reduction Feature .....	22
■ Adjusting the Volume.....	22
■ Switching the Sound Off Temporarily .....	23
■ Changing the Sound Standard .....	23
■ Adjusting the Sound Settings .....	24
■ Extra Sound Settings.....	25
■ Enjoying the Woofer Sound.....	26
■ Selecting the Turbo Sound.....	26
■ Selecting the Sound Mode .....	27
■ Setting the Sleep Timer .....	28
■ Setting and Displaying the Current Time.....	29
■ Setting the On/Off Timers, On Time Program and Volume .....	30
■ Setting the Reminder .....	32
■ Setting the Blue Screen Mode.....	34
■ Activating the Childlock .....	34
■ Enjoying Games.....	35
◆ INFORMATION ON CONNECTIONS AND RECOMMENDATIONS FOR USE	
■ Connecting to the AV-1 or 2 Input/Outputs.....	36
■ Connecting to the Rear S-VIDEO Input.....	36
■ Connecting to the Rear DVD Input.....	37
■ Connecting to the RCA Input (AV2).....	37
■ Connecting Headphones.....	38
■ Viewing Picture From External Sources.....	38
■ Automatic Degaussing to Remove Colour Patches.....	39
■ Trouble Shooting: Before Contacting Service Personnel .....	39

Symbols



## Front Control Panel (depending on the model)

ENG

➤ Buttons and markings are subject to change.

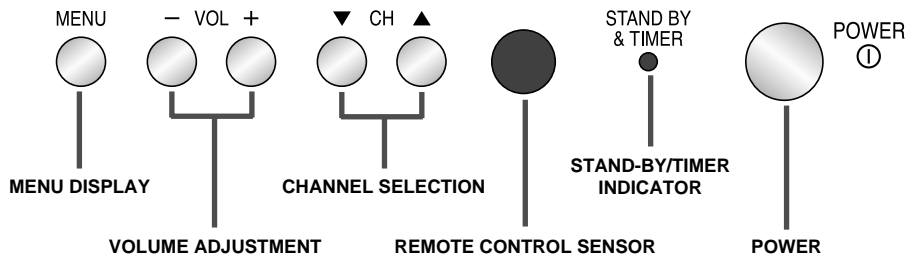
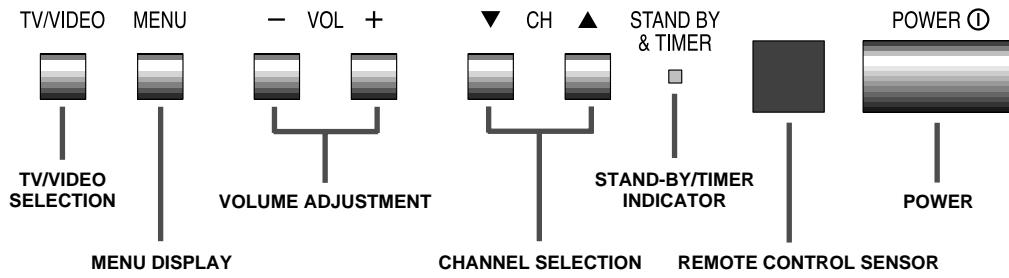

# Connection Panels

☞ This figure shows the Standard Connector-jack panel. The actual configuration on your TV may be different, depending on the model.

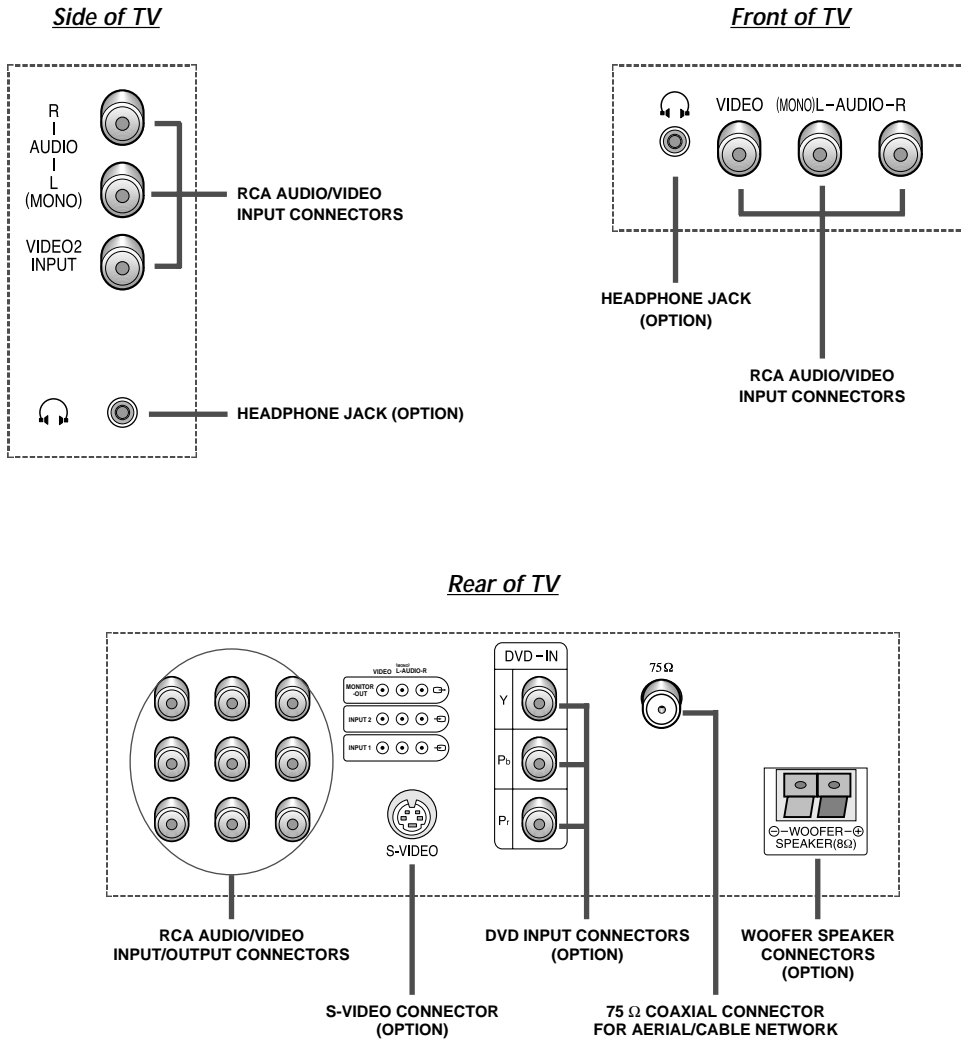

## Infrared Remote Control (depending on the model)

➤ Buttons and markings are subject to change

ENG

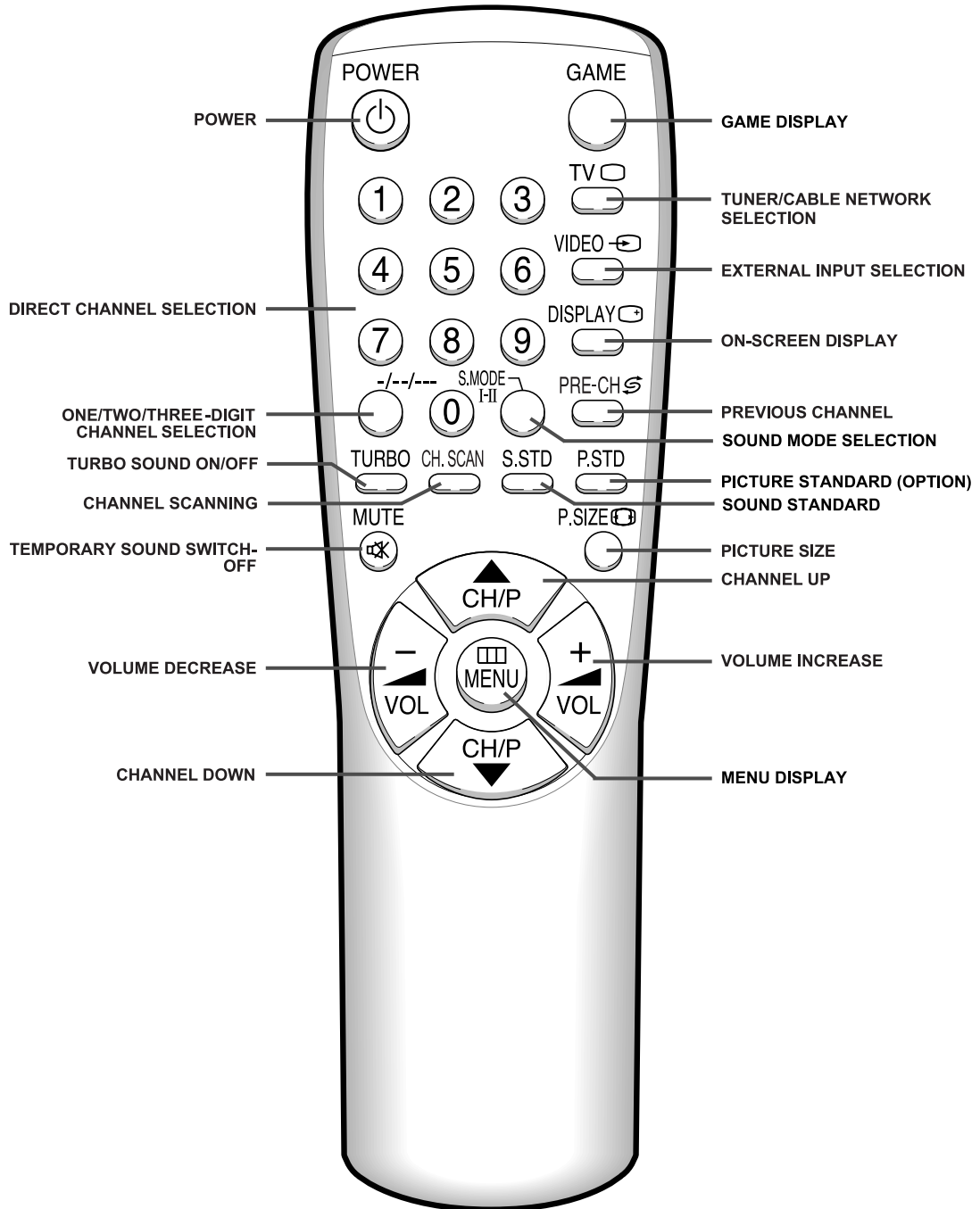

➤ Operation of remote control may be affected by bright artificial light near to the TV set.

## Inserting the Batteries in the Remote Control

ENG

*You must insert or replace the batteries in the remote control when you :*

- ◆ *Purchase the television.*
- ◆ *Find that the remote control is no longer operating correctly.*

- 1** Remove the cover of the remote control by pressing the symbol (PRESS) and pulling the cover in the direction of the arrow.
- 2** Insert batteries, taking care to respect the polarities:
  - ◆ + on the battery with + on the remote control
  - ◆ - on the battery with - on the remote control
- 3** Replace the cover by pushing it in the direction of the arrow.

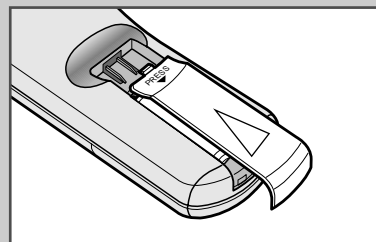
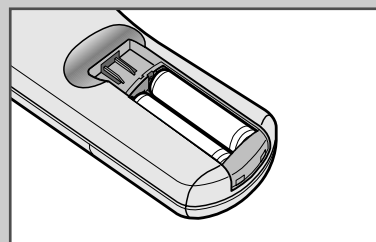
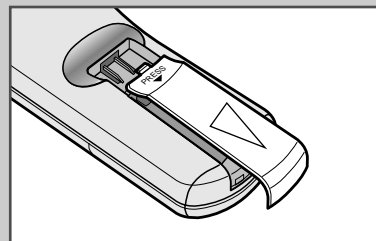

## Connecting the Aerial (or Cable Television Network)

*To view television channels correctly, a signal must be received by the set from one of the following sources:*

- ◆ *An outdoor aerial*
- ◆ *A cable television network*

Plug the aerial or cable network input cable to the 75Ω coaxial socket on the rear of the television.

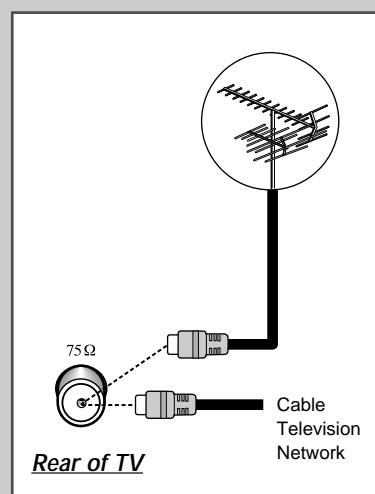

## Switching Your Television On and Off

ENG

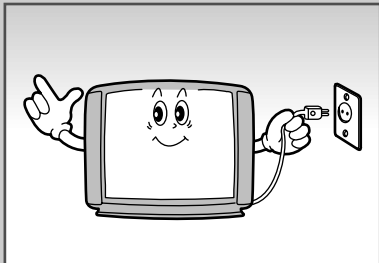

*The mains lead is attached to the rear of the television.*

- 1** Plug the mains lead into an appropriate socket.
  - The main voltage is indicated on the rear of the TV set and the frequency is 50 or 60Hz.
- 2** Press the “⏻” (ON/OFF) button on the front of the television.  
Result: The Standby indicator lights up on the front panel.
- 3** Press the **POWER** ⏻ button on the remote control to switch the television on.  
Result: The programme that you were watching last is re-selected automatically.
- 4** To switch your television off, press the “⏻” (ON/OFF) button again on the front of the television.



## Placing Your Television in Standby mode

ENG



Your television can be placed in Standby mode, in order to reduce:

- ◆ Power consumption
- ◆ Wear of the cathode ray tube

The Standby mode can be useful when you wish to interrupt viewing temporarily (during a meal, for example).

The television is placed automatically in Standby mode when you turn it on.



- 1** Press the **POWER**  button on the remote control.  
**Result:** The screen is turned off and the Standby indicator on the front of the television lights up.
- 2** To switch the screen back on, simply press the **POWER**  button again on the remote control.

- Do not leave your television in standby mode for long periods of time (when you are away on holiday, for example). In this case, you should switch it off completely.

## Plug & Play Feature

ENG

Plug & Play

Ant. Input : Check

⏏ Select    ⏏ Exit

Auto store

Area	: ASIA W/EUROPE
Search	: -/+

⏏ Select    ⏏ Adjust    ⏏ Exit

Time

Sleep	: Off
Clock	: -- : -- am
Timer	▶

⏏ Select    ⏏ Adjust    ⏏ Exit

Function

Language	: English
Time	▶
Plug & Play	▶
Blue screen	: Off
Demonstration	▶

⏏ Select    ⏏ Enter    ⏏ Exit

Function

Language	: English
Time	▶
Plug & Play	▶
Blue screen	: Off
Demonstration	▶

⏏ Select    ⏏ Enter    ⏏ Exit

*When the television is initially powered ON, three basic customer settings proceed automatically and subsequently: setting the language, channel and clock.*

- 1 If the television is in Standby mode (red light visible on the television front panel), press the **POWER**  button on the remote control.

**Result:** The message “Plug & Play” is displayed. It flickers for a little while and then the “Language” menu is automatically displayed.

- 2 Press the **▲** or **▼** button to select required language. Press the **MENU** button to enter the language, and then the message “Ant. Input : Check” is displayed.

➤ If any language is not selected on the “Language” menu, the “Language” menu will be displayed about 30 seconds later.

- 3 Make sure that the antenna is connected to the TV. And then press the **+** or **-** button.

**Result:** The “Auto store” menu is displayed.

- 4 Select your country by pressing the **+** or **-** button. To search the channels, select the “Search” by pressing the **▲** or **▼** button, and then press the **+** or **-** button (refer to “Storing the Channels Automatically” on page 13). Press the **MENU** button to skip.

**Result:** The “Time” menu is displayed.

- 5 Press the **+** or **-** button to move to the hour or minute. Set the hour or minute by pressing the **▲** or **▼** button (refer to “Setting and Displaying the Current Time” on page 28).

- 6 When you have finished, press the **MENU** button.

**Result:** The message “ENJOY YOUR WATCHING” is displayed, and then the channel which has been stored will be activated.

- 7 **If you want to reset this feature...**

- 1 Press the **MENU** button.

- 2 Press the **▲** or **▼** button to select the “Function”, and then press the **+** or **-** button.

- 3 Select the “Plug & Play” by pressing the **▲** or **▼** button, and then press the **+** or **-** button.

**Result:** The message “Plug & Play” is displayed.

## Viewing the Demonstration

ENG

To become familiar with the various menus provided by your television, you can view the inbuilt demonstration.

- 1 Press the **MENU** button.
- 2 Press the **▲** or **▼** button to select the "Function" and press the **+** or **-** button.
- 3 Press the **▲** or **▼** button to select the "Demonstration" and press the **+** or **-** button.

Result: Each of the menu options is displayed in turn.

- 4 When you wish to stop the demonstration, press any button on the remote control.

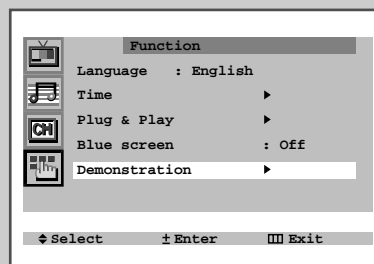
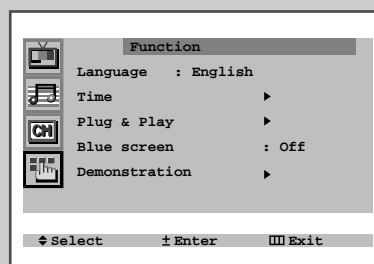
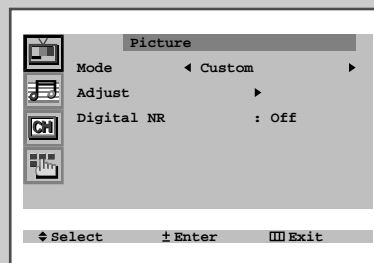

## Choosing Your Language

ENG

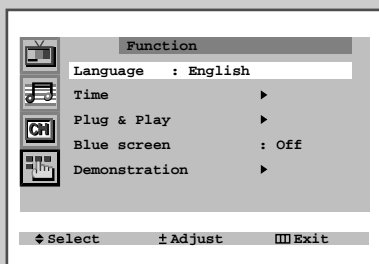
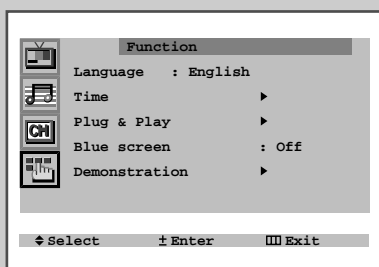
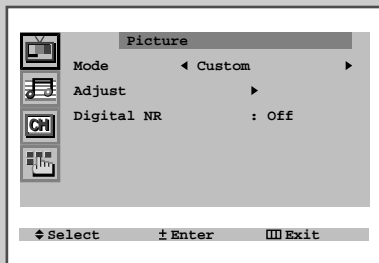

*When you start using your television for the first time, you must select the language which will be used for displaying menus and indications.*

- 1 Press the **MENU** button.
- 2 Press the ▲ or ▼ button to select the "Function".
- 3 Press the + or – button to select the "Language".
- 4 Select a particular language by pressing the ▲ or ▼ button repeatedly.
- 5 When you have finished, press the **TV** button or, press the **MENU** button repeatedly to return to normal viewing.

## Storing the Channels Automatically

ENG

You can scan the frequency ranges available on your television and in your area and store all the channels found automatically.

The channels are stored in the order in which they appear in the frequency bands. It is possible that the automatically allocated numbers may not correspond to those by which you wish to identify the channels. If this is the case, refer to "Sorting the Stored Channels" on page 18.

- 1 Press the **MENU** button.
- 2 Press the ▲ or ▼ button to select the "Channel".
- 3 Press the + or – button to select the "Auto store".
- 4 Press the + or – button again.  
Result: The "Auto store" menu is displayed with the "Area" selected.
- 5 Select your country by pressing the + or – button. The following countries are available: ASIA W/EUROPE - CIS E/EUROPE - CHINA - HONGKONG U/K - AUSTRALIA - NZ/INDONESIA - SOUTH AFRICA - AMERICA.
- 6 Press the ▲ or ▼ button to select the "Search" and press the + or – button.  
Result: The horizontal bar is displayed, and then channels are stored in an order which reflects their positions in the frequency range. Finally, the search will end automatically.

- 7 When searching and storing is complete, the "Sort" menu is displayed.

To...	Then...
Sort the stored channels into the desired numerical order	Go to Step 4 of the "Sorting the Stored Channels" procedure on page 18.
Exit the channel store function without sorting the channels	Press the <b>MENU</b> button repeatedly until the menus disappear.

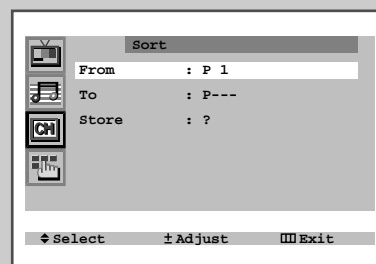
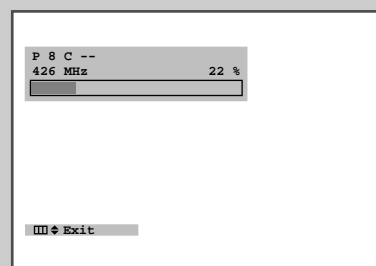
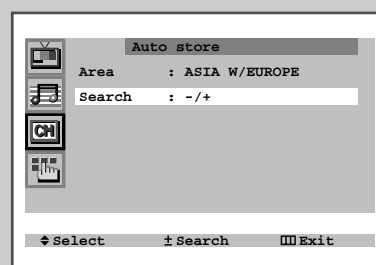
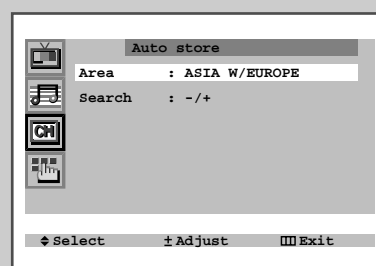
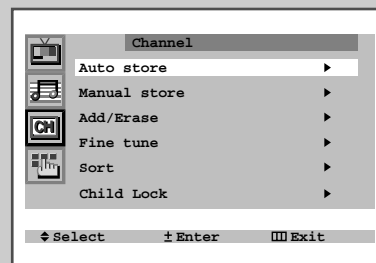

## Storing the Channels Manually

ENG

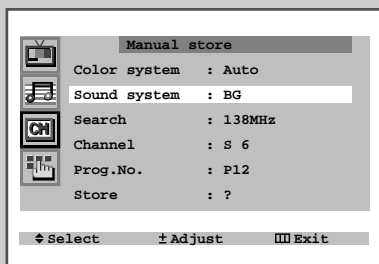
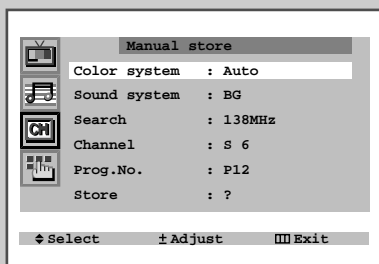
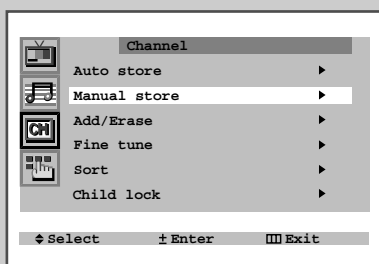
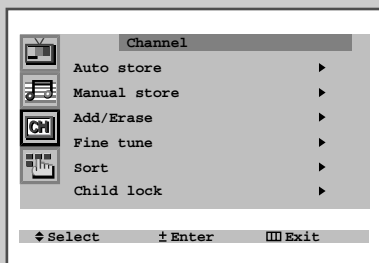

When storing channels manually, you can choose:

- ◆ Whether or not to store each of the channels found.
- ◆ The number by which you wish to identify each stored channel.

1 Press the **MENU** button.

2 Press the **▲** or **▼** button to select the “Channel” and press the **+** or **-** button.

3 Press the **▲** or **▼** button to select the “Manual store” and press the **+** or **-** button.

Result: The “Manual store” menu is displayed with the “Color system” selected.

4 Press the **+** or **-** button repeatedly until the color is of the best quality.

Result: The “Color system” is changed.

**Auto** ↔ **PAL** ↔ **SECAM** ↔ **NT4.43** ↔ **NT3.58** (option)



➤ NT4.43 is a “trick” playback mode used by special VCR’s to play PAL-recorded videos in NTSC mode.

5 Press the **▲** or **▼** button to select the “Sound system” and press the **+** or **-** button repeatedly until the sound is of the best quality.

Result: The “Sound system” is changed.

**BG** ↔ **DK** ↔ **I** ↔ **M** (option)



## Storing the Channels Manually (continued...)

ENG

6	If you...	Press the...
	Know the number of the channel to be stored	<ul style="list-style-type: none"> <li>◆ ▲ or ▼ button to select the "Channel".</li> <li>◆ + or - button to indicate the required number.</li> </ul>
	Do not know the channel numbers	<ul style="list-style-type: none"> <li>◆ ▲ or ▼ button to select the "Search".</li> <li>◆ + or - button to start the search.</li> </ul>

**Result:** The tuner scans the frequency range until the first channel or the channel that you selected is received on your screen.

**7** To assign a programme number to the channel, select the "Prog.No.". Press the + or - button until you find the correct number.

**8** To store the channel and associated programme number, select the "Store" and press the + or - button.

**Result:** "OK" is displayed.

**9** Repeat Steps **6** to **8** for each channel to be stored.

**10** When you have finished manual storage, press the **TV** button or, press the **MENU** button repeatedly to return to normal viewing

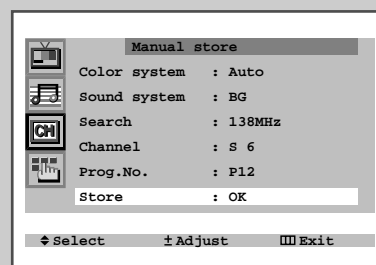
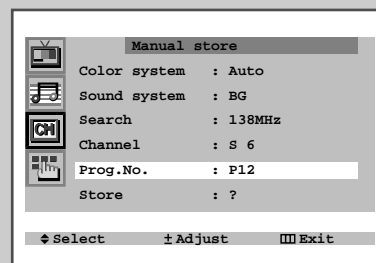
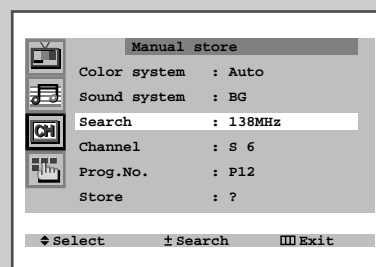
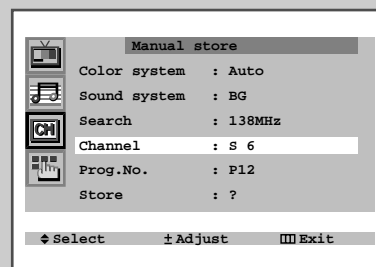

## Skipping Unwanted Channels

ENG

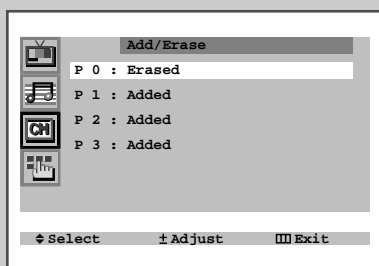
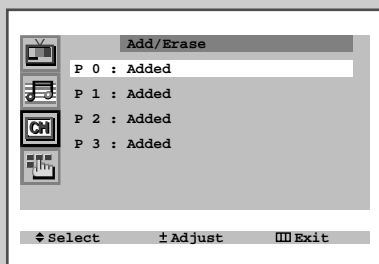
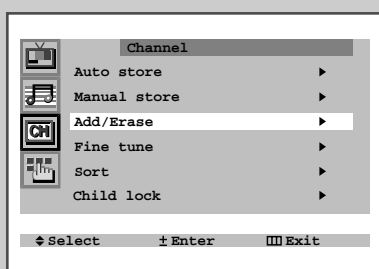
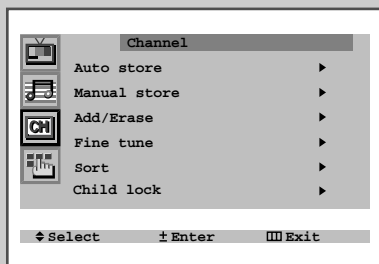

*You can exclude the channels of your choice from the channel scan operation. When you scan through the stored channels, those you have chosen to skip are not displayed.*

*All channels that you do not specifically choose to skip are displayed during scanning.*

- 1 Press the **MENU** button.
- 2 Press the **▲** or **▼** button to select the "Channel" and press the **+** or **-** button.
- 3 Press the **▲** or **▼** button to select the "Add/Erase" and press the **+** or **-** button.  
Result: The "Add/Erase" menu is displayed.
- 4 Press the **▲** or **▼** button to select the required channel.
- 5 To add or erase the desired channel by pressing the **+** or **-** button.
- 6 When you have finished adding and erasing channels, press the **TV** button or, press the **MENU** button repeatedly to return to normal viewing.



## Fine tuning Channel Reception

ENG

*If the reception is clear, you do not have to fine-tune the channel, as this is done automatically during the search and store operation. If however the signal is weak or distorted, you may have to fine-tune the channel manually.*

- 1 Press the **MENU** button.
- 2 Press the **▲** or **▼** button to select the "Channel" and press the **+** or **-** button.
- 3 Press the **▲** or **▼** button to select the "Fine tune" and press the **+** or **-** button.

Result: The "Fine tune" menu is displayed with the "Tune" selected.

4 To...	Press the...
obtain a sharp and clear picture and good sound quality	<ul style="list-style-type: none"> <li>◆ <b>+</b> or <b>-</b> button.</li> <li><u>Result:</u> The horizontal bar's cursor moves to the left or right.</li> </ul>
memorise adjusted picture or sound	<ul style="list-style-type: none"> <li>◆ <b>▲</b> or <b>▼</b> button to select the "Store".</li> <li>◆ <b>+</b> or <b>-</b> button.</li> <li><u>Result:</u> "OK" is displayed.</li> </ul>
erase adjusted picture or sound	<ul style="list-style-type: none"> <li>◆ <b>▲</b> or <b>▼</b> button to select the "Erase".</li> <li>◆ <b>+</b> or <b>-</b> button.</li> <li><u>Result:</u> "OK" is displayed.</li> </ul>

When you have finished, press the **TV** button or, press the **MENU** button repeatedly to return to normal viewing.

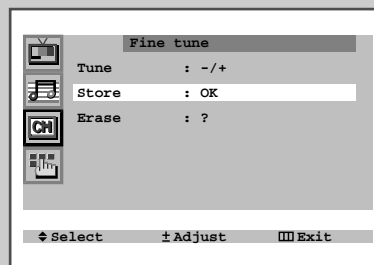
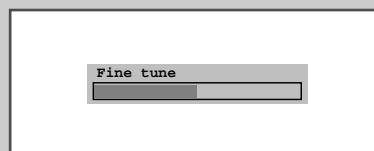
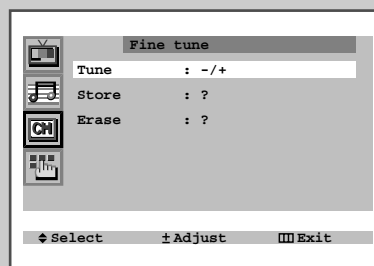
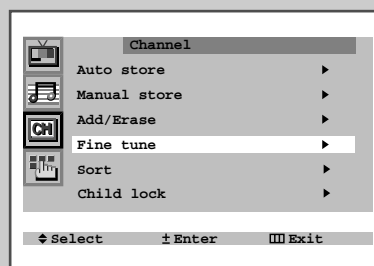
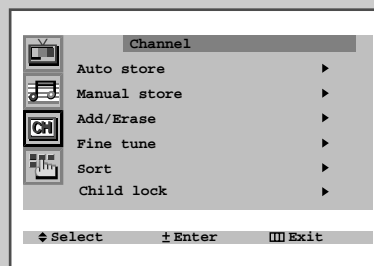

## Sorting the Stored Channels

ENG

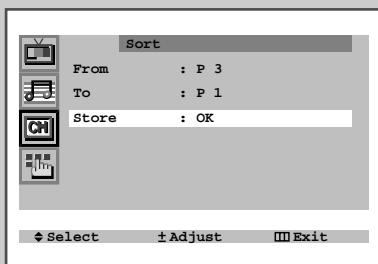
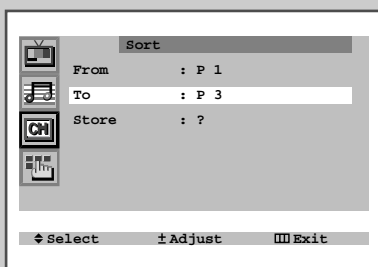
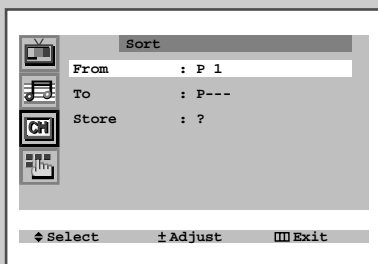
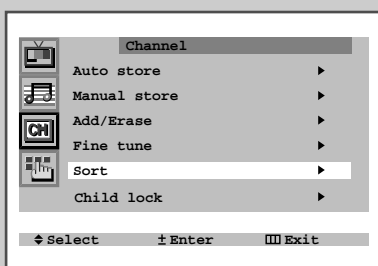
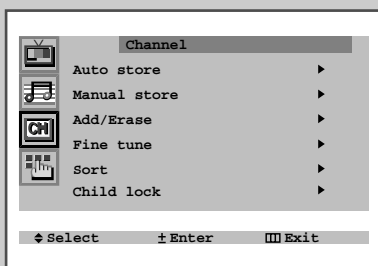

You can exchange the numbers of two channels, in order to:

- ◆ Modify the numeric order in which the channels have been automatically stored.
- ◆ Give easily remembered numbers to the channels that you watch most often.

- 1 Press the **MENU** button.
- 2 Press the **▲** or **▼** button to select the "Channel" and press the **+** or **-** button.
- 3 Press the **▲** or **▼** button to select the "Sort" and press the **+** or **-** button.  
Result: The "Sort" menu is displayed with the "From" selected.
- 4 Press the **+** or **-** button until the channel number that you wish to change is displayed.  
Result: The selected channel's picture is displayed.
- 5 Press the **▲** or **▼** button to select the "To".
- 6 Press the **+** or **-** button until the new number by which you wish to identify the channel is displayed.  
Result: The selected channel is exchanged with the one previously stored to the chosen number.  
Example: If you select "P 1" for the "From" and "P 3" for the "To":
  - ◆ Channel 1 becomes channel 3.
  - ◆ Channel 3 becomes channel 1.
- 7 

<b>To...</b>	<b>Press the...</b>	
Confirm the exchange of channel numbers	◆ <b>▲</b> or <b>▼</b> button to select the "Store".	
	◆ <b>+</b> or <b>-</b> button.	
	<u>Result:</u> "OK" is displayed.	
	➤ You can exchange other channel numbers by selecting "From" and returning to step 4.	
- 8 When you have finished sorting channels, press the **TV** button or, press the **MENU** button repeatedly to return to normal viewing

## Changing Channels

Once you have stored the channels on your television, you can switch easily from one channel to another using the remote control.

To switch...	Press...
To the next channel	▲
To the previous channel	▼
To another channel	The numeric button(s) corresponding to that channel.

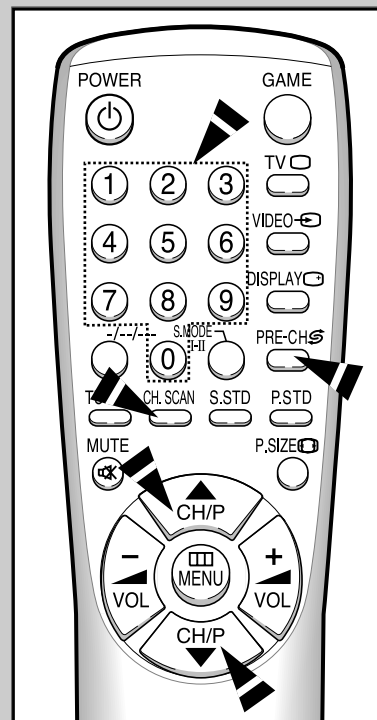

ENG

## Pre - Channel

Press PRE-CH (Pre Channel button) to switch repeatedly between last two channels displayed. This can be done as many times as required.

## Channel Scan

Press CH.SCAN (Channel Scan button) for a 2 Second review of each new added channel.

## Selecting a Channel Numbered Ten or Over

When using the numeric buttons to select a channel stored at programme position ten or higher, follow the instructions below.

- Press the **-/--/---** button.  
**Result:** The **"-"** or **"--"** or  **"---"** symbol is displayed.
- Enter the two-digit channel number or three-digit channel number.  
**Example:** To select channel 42, Press **-/--/---** till **"--"** is displayed. Then press 4, followed by 2.  
 To select channel 187, Press **-/--/---** till  **"---"** is displayed. Then press 1, followed by 8, followed by 7.



## Changing the Picture Standard

ENG

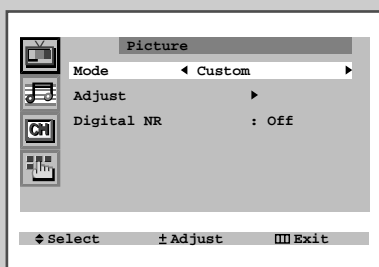
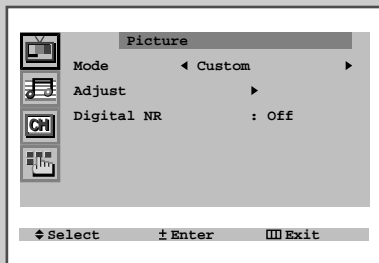

You can select the type of picture which best corresponds to your viewing requirements. The following picture effects are available in the order given:

◆ Custom, Standard, Sports, Natural, Mild.

- 1 Press the **MENU** button.  
Result: The "Picture" menu is displayed.
- 2 Press the **+** or **-** button to select the "Mode".
- 3 Press the **+** or **-** button repeatedly to cycle through the five choices: **Custom, Standard, Sports, Natural, Mild**.  
These picture standards are saved for each channel.
- 4 When you are satisfied with the settings, press the **TV** button or, press the **MENU** button repeatedly to return to normal viewing.

You can use your remote control to select the type of picture which best corresponds to your viewing requirements.

To select the required picture effect, simply press the **P.STD** (Picture standard) button on the remote control.

Result: The following picture effects are available in the order given:

**Custom ↔ Standard ↔ Sports ↔ Natural ↔ Mild**

# Adjusting the Picture Settings

Your television has several settings which allow you to control picture quality:

- ◆ Color tone, Contrast, Brightness, Color, Sharpness, Tint (NTSC only)

- 1 Press the **MENU** button.  
Result: The "Picture" menu is displayed.
- 2 Press the **+** or **-** button.
- 3 Press the **▲** or **▼** button to select the "Adjust", and then press the **+** or **-** button.  
Result: The "Adjust" menu is displayed.  
➤ When select the "Mode" to "Custom", the "Adjust" menu is displayed.
- 4 

To adjust the...	Press the...
◆ Color tone	◆ <b>+</b> or <b>-</b> button. Result: You select the required option (Normal, Warm1/2, Cool1/2).
◆ Contrast	◆ <b>+</b> or <b>-</b> button. Result: The horizontal bar is displayed.
◆ Brightness	
◆ Sharpness	
◆ Color	
◆ Tint (NTSC only)	
- 5 When you are satisfied with the settings, press the **TV** button or, press the **MENU** button repeatedly to return to normal viewing.

- The television has an "automatic degaussing" system that is activated if magnetic interference is present. To degauss the television screen, switch power off by pressing the "Ⓞ" (ON/OFF) button on the front panel (refer to "Automatic Degaussing To Remove Colour Patches" on page 35).
- If you make any changes to the "Adjust" settings, the picture standard is automatically switched to "Custom".

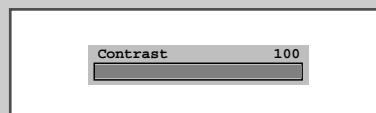
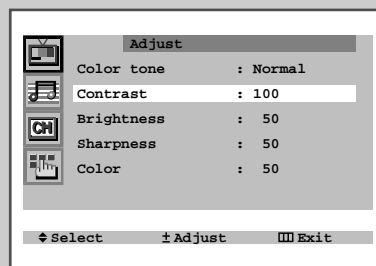
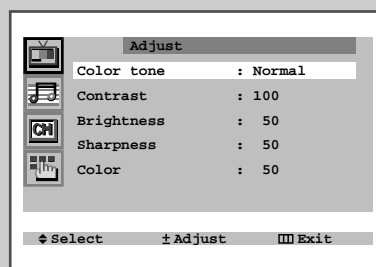
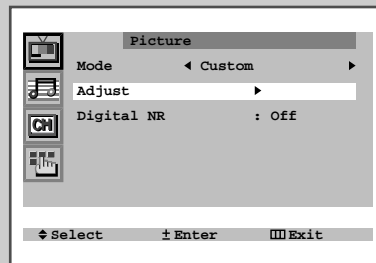

# Selecting the Picture Format (depending on the model)

You can select the picture format which best corresponds to your viewing requirements by simply pressing the "P.SIZE" button.

Picture format	Description
Plus	Full 12.8:9 format (extra 1 inch)
Normal	Setting for normal 4:3 format.
Zoom	Expansion of a 16:9 picture to full screen format.
16:9	Setting for the 16:9 screen format

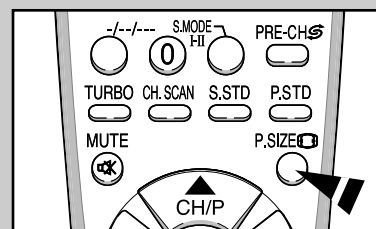

## Activating/Deactivating the Digital Noise Reduction Feature

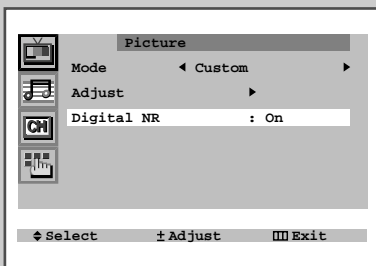
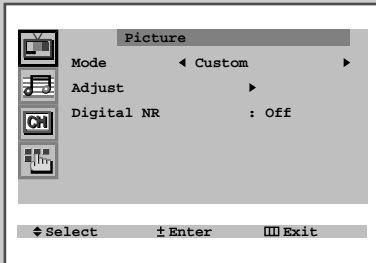

*If the broadcast signal received by your television is weak, you can activate the Digital Noise Reduction feature to help reduce any static and ghosting that may appear on the screen.*

- 1 Press the **MENU** button.  
Result: The "Picture" menu is displayed.
- 2 Press the **+** or **-** button.
- 3 Press the **▲** or **▼** button to select the "Digital NR".
- 4 To select the "On" press the **+** or **-** button.
- 5 When you have finished, press the **TV** button or, press the **MENU** button repeatedly to return to normal viewing.

## Adjusting the Volume

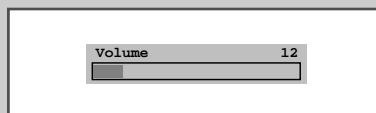
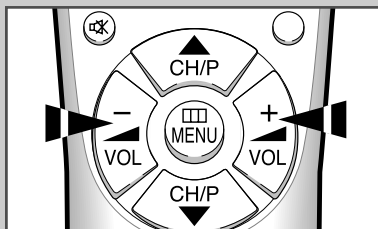



- ◆ Press the **+** button to increase the volume (cursor moves to the right)
- ◆ Press the **-** button to decrease the volume (cursor moves to the left)

- Different Volume levels can be adjusted and saved at each channel.
- The volume setting is retained:
  - ◆ When you switch the television to standby mode
  - ◆ When you switch the television off using the "Ⓞ" (ON/OFF) button on the front panel
  - ◆ If there is a power failure.

## Switching the Sound Off Temporarily

You can switch the sound off temporarily, for example you may wish to answer the telephone.

- 1 Press the **MUTE**  button.  
**Result:** The sound is switched off and "" is displayed.
- 2 When you wish to turn the sound back on at the same volume as before, press the **MUTE**  button again (or either of the volume buttons).

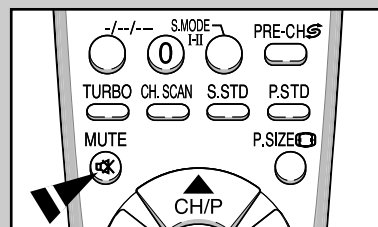

## Changing the Sound Standard (depending on the model)

You can select the type of special sound effect to be used when watching a given broadcast. The following sound effects are available in the order given:

- ◆ *Custom, Standard, Music, Movie, Speech.*

- 1 Press the **MENU** button.
- 2 Press the **▲** or **▼** button to select the "Sound" and press the **+** or **-** button.  
**Result:** The "Mode" is selected.
- 3 Press the **+** or **-** button repeatedly to cycle through the five choices: **Custom, Standard, Music, Movie, Speech.**  
These sound standards can be saved for each channel.
- 4 When you are satisfied with the settings, press the **TV** button or, press the **MENU** button repeatedly to return to normal viewing.

You can use your remote control to select the type of special sound effect to be used when watching a given broadcast.

To select the required sound effect, simply press the **S.STD** (Sound standard) button on the remote control.

**Result:** The following sound effects are available in the order given:

**Custom ↔ Standard ↔ Music ↔ Movie ↔ Speech**

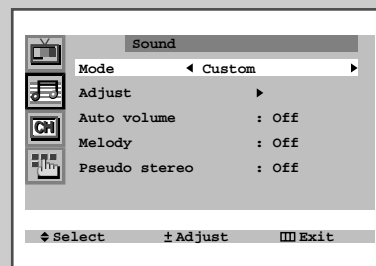
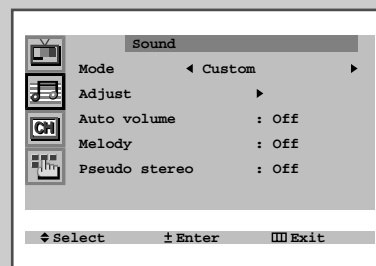

## Adjusting the Sound Settings (depending on the model)

ENG

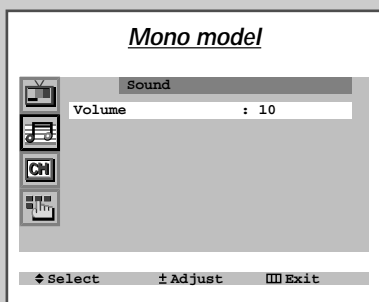
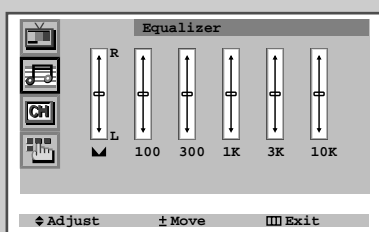
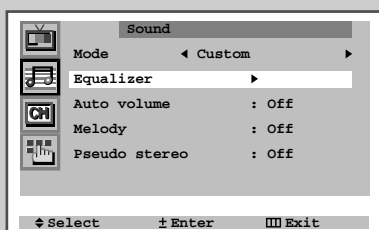
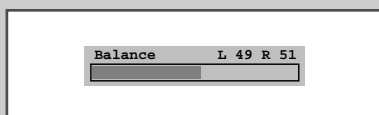
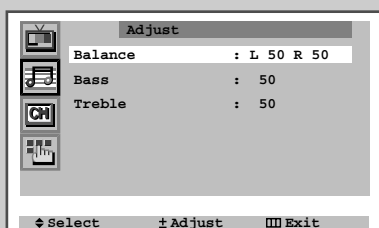
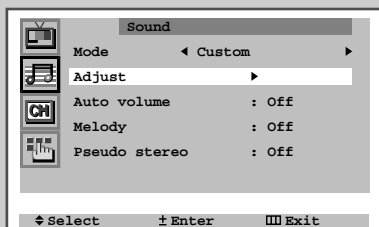

The sound settings can be adjusted to suit your personal preferences.

- 1 Press the **MENU** button.
- 2 Press the **▲** or **▼** button to select the "Sound" and press the **+** or **-** button.
- 3 Press the **▲** or **▼** button to select the "Adjust" (or "Equalizer").
  - When select the "Mode" to "Custom", the "Adjust" (or "Equalizer") menu is displayed.
- 4 Press the **+** or **-** button.
 

Result: The "Adjust" (or "Equalizer") menu is displayed.
- 5 Select the required option and adjust to satisfy your preference.
- 6 When you are satisfied with the settings, press the **TV** button or, press the **MENU** button repeatedly to return to normal viewing.



## Extra Sound Settings (depending on the model)

ENG

The following sound settings can be adjusted to suit your personal preferences.

### ◆ Auto volume

Each broadcasting station has its own signal conditions, and so it is not easy for you to adjust the volume every time the channel is changed. "Auto volume" lets you automatically adjust the volume of the desired channel by lowering the sound output when the modulation signal is high or by raising the sound output when the modulation signal is low. This is saved for each channel individually.

### ◆ Melody

You can hear clear melody sound when the TV is powered ON or OFF.

### ◆ Pseudo stereo

"Pseudo stereo" converts a monaural sound signal into two identical left and right channels. Once the "Pseudo stereo" is set to "On" or "Off", the setting applies to the sound effects such as Standard, Music, Movie and Speech. This is saved for each channel individually.

- 1 Press the **MENU** button.
- 2 Press the **▲** or **▼** button to select the "Sound" and press the **+** or **-** button.
- 3
 

To...	Press the...
Change an option	<b>▲</b> or <b>▼</b> button.
Select the required option (On/Off)	<b>+</b> or <b>-</b> button.
- 4 When you are satisfied with the settings, press the **TV** button or, press the **MENU** button repeatedly to return to normal viewing.

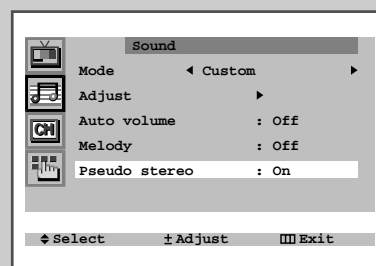
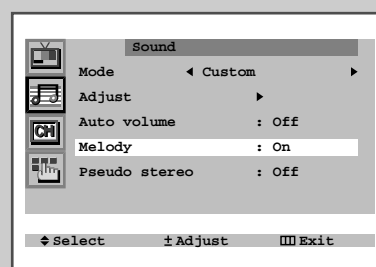
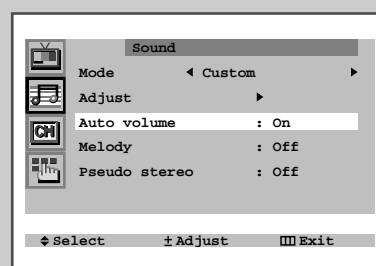
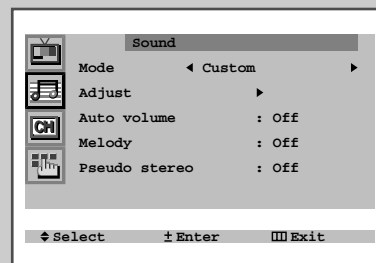

## Enjoying the Woofer Sound (depending on the model)

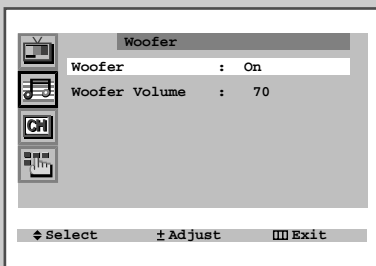
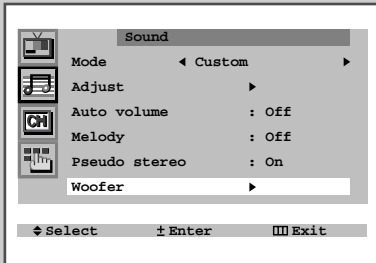

*When the woofer speaker is mounted to the TV, you can hear the bass sound-effect (if not mounted, the volume is much lower).*

*Remove the packing materials between the woofer speaker and TV. Attach the woofer speaker ribs in the holes on the top of the TV. Connect the woofer speaker jacks to the TV rear panel inputs and follow the below.*

- 1 Press the **MENU** button.
- 2 Press the **▲** or **▼** button to select the "Sound" and press the **+** or **-** button.
- 3 Press the **▲** or **▼** button to select the "Woofer".
- 4 Press the **+** or **-** button.  
Result: The "Woofer" menu is displayed with the "Woofer" is set to "On".
- 5 Select the "Woofer Volume" by pressing the **▲** or **▼** button and adjust to satisfy your preference.
- 6 When you are satisfied with the settings, press the **TV** button or, press the **MENU** button repeatedly to return to normal viewing.

➤ When you use headphones, first turn off the woofer.

## Selecting the Turbo Sound (depending on the model)

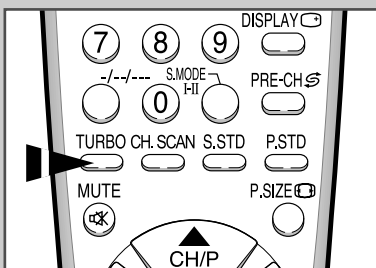

Turbo sound : On

*Turbo sound suitably emphasizes both higher and lower bands of sound (and includes other effects).*

To enjoy more magnificent and dynamic sound when watching music, movie or other channel, simply press the **TURBO** button on the remote control. This is saved for each channel individually.



## Setting the Sleep Timer

ENG

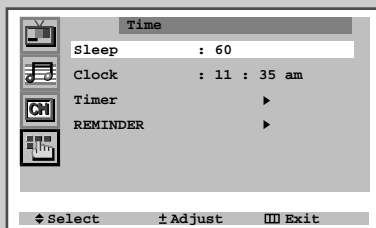
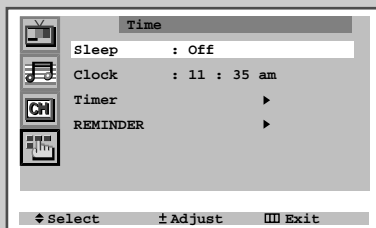
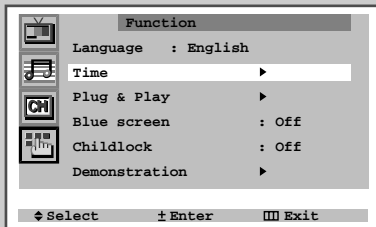

You can select a time period of between 30 and 180 minutes after which the television automatically switches to Standby mode.

- 1 Press the **MENU** button.
- 2 Press the **▲** or **▼** button to select the "Function " and press the **−** or **+** button.
- 3 Press the **▲** or **▼** button to select the "Time" , and press the **−** or **+** button.  
Result: " Sleep" is selected.
- 4 Press the **−** or **+** button repeatedly and cycle through the preset time intervals (30, 60, 90, 120, 150, 180).  
Result: The television automatically switches to standby mode after the time elapses.
- 5 To cancel the sleep timer function,repeat steps 1 to 3. Press the **−** or **+** button repeatedly and select "Off"
- 6 When you have finished setting the sleep Timer press the TV button or, press the "MENU" button repeatedly to return to normal viewing.

## Setting and Displaying the Current Time

ENG

You can set the television's clock so that the current time is displayed when you press the "DISPLAY" button.

You must also set the time if you wish to use the automatic On/Off timers.

➤ The clock setting will be re-activated when pressing the "⓪" (ON/OFF) button on the front panel.

- 1 Press the **MENU** button.
- 2 Press the **▲** or **▼** button to select the "Function" and press the **-** or **+** button.
- 3 Press the **▲** or **▼** button to select the "Time", and press the **-** or **+** button.  
Result: The "Time" menu is displayed with the "Sleep" selected.
- 4 Press the **▲** or **▼** button to select the "Clock".
- 5

To...	Press the...
Move to the hour or minute	<b>-</b> or <b>+</b> button.
Set the hour or minute	<b>▲</b> or <b>▼</b> button.
- 6 When you have finished, press the **TV** button or, press the button repeatedly to return to normal viewing.
- 7

To display the...	Press the DISPLAY button...
Channel information	Once.
Current time	Twice.
- 8 To remove the display, press the **DISPLAY** button again.

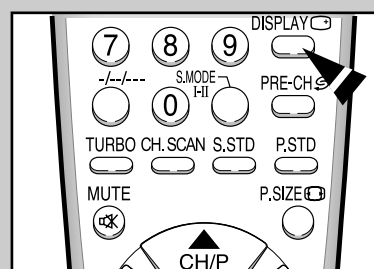
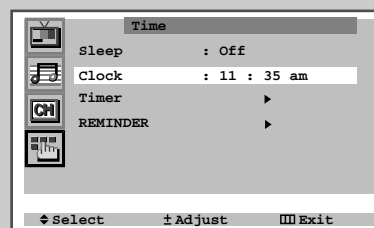
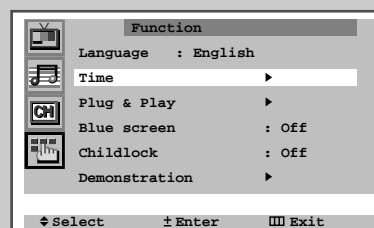

## Setting the On/Off Timers, On Time Program and Volume

ENG

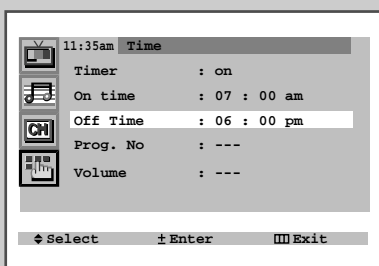
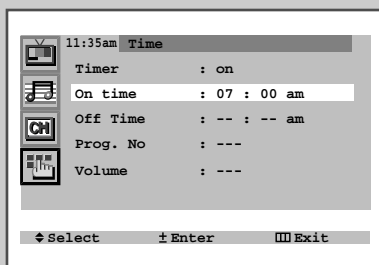
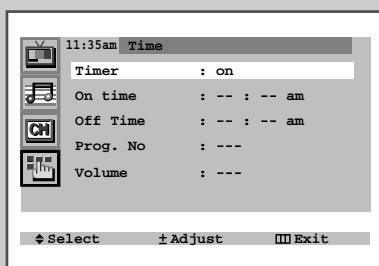
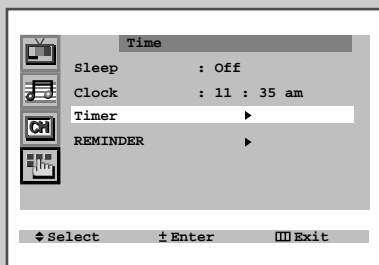

You can set the On/Off timers so that the television will:

- ◆ Switch on automatically and tune to the channel and volume of your choice at the time you select
  - ◆ Switch off automatically at the time you select
- The first step is to set the television's clock (refer to "Setting and Displaying the Current Time" on the previous page). If you have not yet set the clock, the message "Set the clock first" is displayed.

- 1 Press the **MENU** button.
- 2 Press the **▲** or **▼** button to select the "Function" and press the **-** or **+** button.
- 3 Press the **▲** or **▼** button to select the "Time", and press the **-** or **+** button.  
Result: The "Time" menu is displayed.
- 4 Press the **▲** or **▼** button to select the "Timer", and press the **-** or **+** button.  
Result: The "Time" menu is displayed. with the "Timer" selected.
- 5 Press the **-** or **+** button to set the mode to "On".  
Result: The "On time", "Off time", "Prog. No" and "Volume" options are displayed.
- 6 Press the **▲** or **▼** button to select the "On time".
- 7 Set the time at which you wish the television to be switched On.  

To...	Press the...
Move to the hour or minute	<b>-</b> or <b>+</b> button.
Adjust the hour or minute	<b>▲</b> or <b>▼</b> button.
- 8 In the same way, set the time at which you wish the television to be switched Off.

## Setting the On/Off Timers, On Time Program and Volume

Continued..... from page 30

ENG

- 9 Press the ▲ or ▼ button to select the "Prog. No".
- 10 Set the program with which you wish the television to be switched on by using the - or +button.
- 11 Press the ▲ or ▼ button to select the "Volume".
- 12 Set the Volume at which you wish the television to be switched on by using the - or + button.
- 13 When you have finished setting the On/Off time, Prog. No and Volume, press the TV button or, press the **MENU** button repeatedly to return to normal viewing.

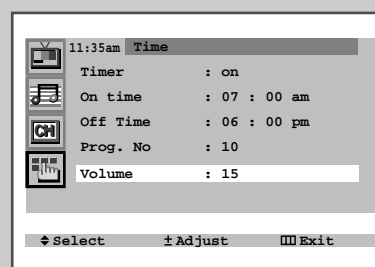
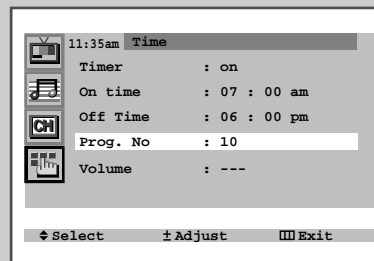

## Setting the Reminder

ENG

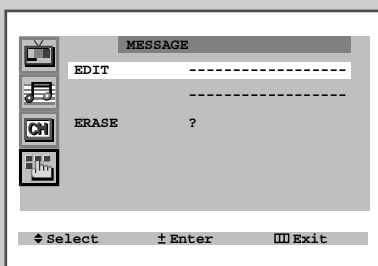
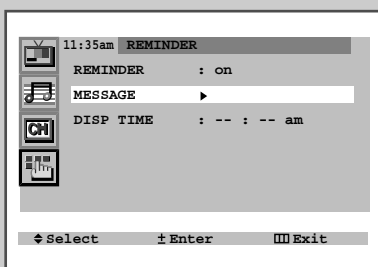
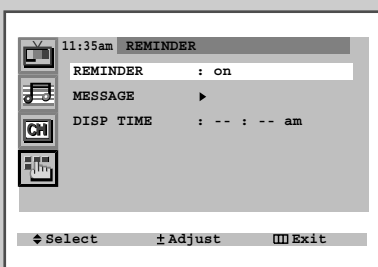
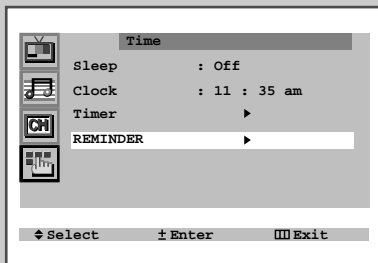

You can set Reminder which will be displayed at the time you have selected while watching the television.

➤ The first step is to set the television's clock (refer to "Setting and Displaying the Current Time" on page 29. If you have not yet set the clock, the message "Set the clock first" is displayed.

- 1 Press the **MENU** button.
- 2 Press the **▲** or **▼** button to select the "Function" and press the **-** or **+** button.
- 3 Press the **▲** or **▼** button to select the "Time", and press the **-** or **+** button.

Result: The "Time" menu is displayed.

- 4 Press the **▲** or **▼** button to select the "REMINDER", and press the **-** or **+** button.

Result: The "REMINDER" menu is displayed with the "REMINDER" Selected.

- 5 Press the **-** or **+** button to set the mode to "On".

Result: The "MESSAGE" and "DISP TIME" options are displayed. The present time is displayed at the left top corner.

- 6 Press the **▲** or **▼** button to select the "MESSAGE" and press **-** or **+** button.

Result: The "MESSAGE" menu is displayed with the "EDIT" selected

- 7 Press the **-** or **+** button to edit the message.





## Setting the Blue Screen Mode

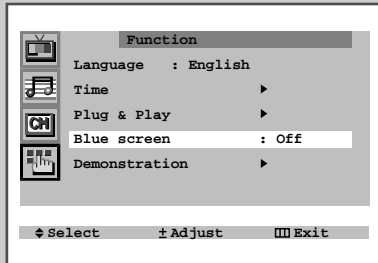

*If no signal is being received or the signal is very weak, a blue screen automatically replaces the noisy picture background.*

*If you wish to continue viewing the poor picture, you must set the "Blue screen" mode to "Off".*

- 1 Press the **MENU** button.
- 2 Press the **▲** or **▼** button to select the "Function" and press the **-** or **+** button.
- 3 Press the **▲** or **▼** button to select the "Blue screen".
- 4 Press the **-** or **+** button to select the required option (On/Off).
- 5 When you have finished, press the **TV** button or, press the **MENU** button repeatedly to return to normal viewing.

## Activating the Childlock

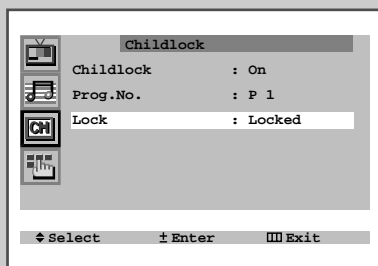
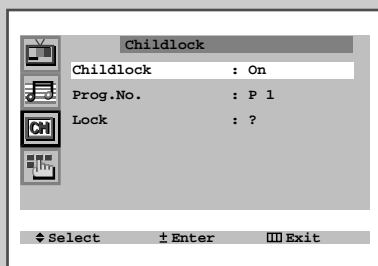
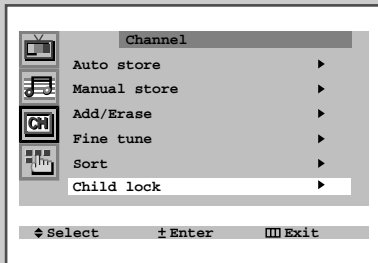

*You can restrict viewing by locking the channels of your choice.*

*Example: You can prevent your children from watching unsuitable programmes.*

- 1 Press the **MENU** button.
- 2 Press the **▲** or **▼** button to select the "Channel" and press the **-** or **+** button.
- 3 Press the **▲** or **▼** button to select the "Childlock" and press the **-** or **+** button.
- 4 Set to "On" by pressing the **-** or **+** button.
  - If you want to unlock a channel, set to "Off".
- 5 Press the **▲** or **▼** button to select the "Prog.No.". Select the number of the channel to be locked by pressing the **-** or **+** button.
- 6 Press the **▲** or **▼** button to select the "Lock" and press the **-** or **+** button.
 

**Result:** "Locked" is displayed.
- 7 When you have finished, press the **TV** button or, press the **MENU** button repeatedly to return to normal viewing.

➤ If any channel is locked, you cannot enter the "Channel" menu (the message "Not available" is displayed).

## Enjoying Games

ENG

You can enjoy the game (Chicken Farm), programmed in this TV.

- 1 Press the **GAME** button to enter the Game mode.  
Result: The READY window will be displayed.
- 2 Press the **-** or **+** button to run the game.
- 3 Move the farmer to catch eggs by using the **-** or **+** button. Every time the scores go up, the speed of game becomes faster bit by bit.
- 4 Every time you catch fifty eggs (i.e., 50, 100, 150 ...), if any broken egg exists, one egg can be restored. When five eggs are lost, the game will be over and simultaneously the final score window will be displayed.
- 5 If you want to stop during the game, press the **MENU** button. Then, the final score window will be displayed.
- 6 If you want to re-start the game, press the **MENU**, **-** or **+** button. Then, the final score window will be switched to the READY window.
- 7 To exit the Game mode, press the **GAME** button.

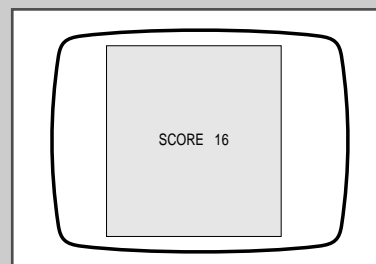
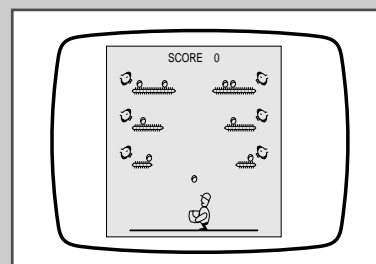
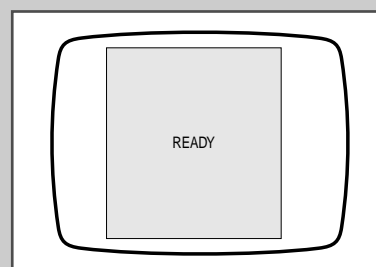

## Connecting to the AV-1 or 2 Input/Outputs

- These figures show typical connector-jack panels. The actual configuration on your TV may be different, depending on your model.

- AV-1 is used for equipment with an RGB output, such as video game devices and video disc players or a VCR.

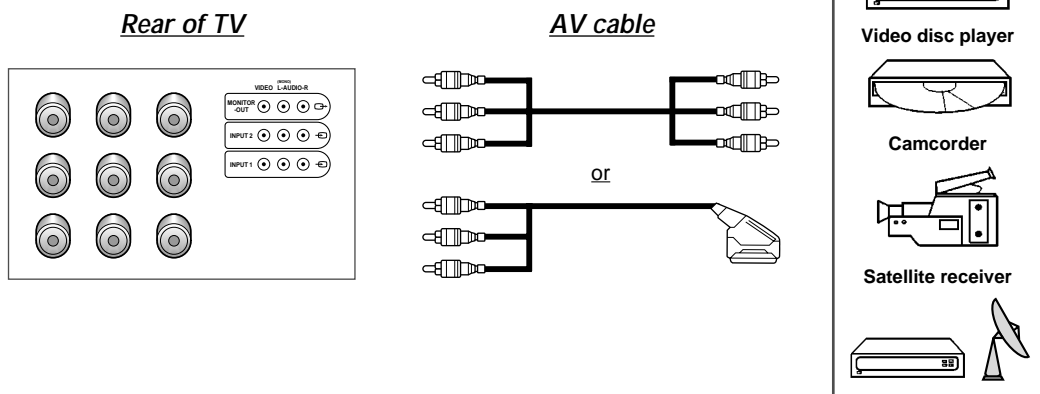

## Connecting to the Rear S-VIDEO Input

- The S-VIDEO/RCA (AUDIO-L and R) connectors are used for equipment with an S-Video output, such as a camcorder or VCR.

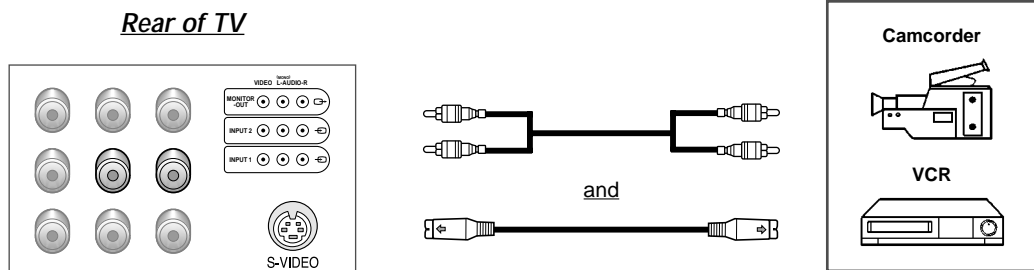

## Connecting to the Rear DVD Input

ENG

- The DVD/RCA (AUDIO-L and R) connectors are used for equipment with a DVD output.

### *Rear of TV*

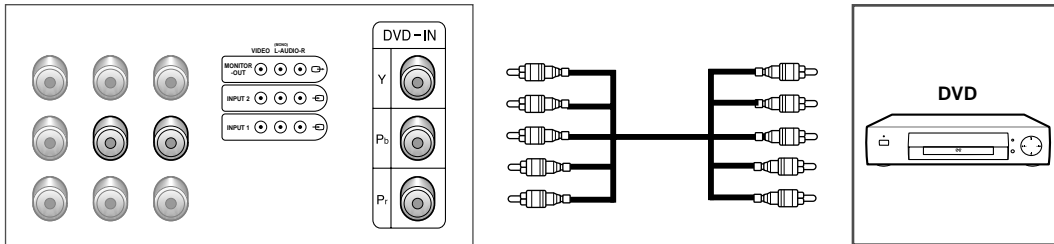

## Connecting to the RCA Input

- The RCA (VIDEO + AUDIO-L and R) connectors are used for equipment such as camcorders, video disc players and some video game devices.

### *Side of TV*

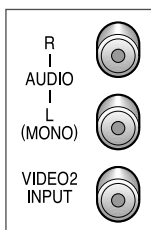

### *Front of TV*

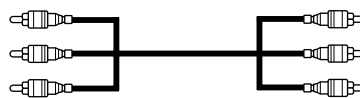
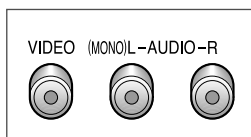

### Camcorder

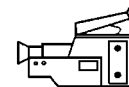

### Video disc player



### Decoder/ Video game device

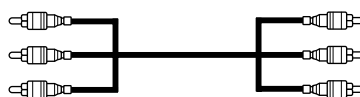
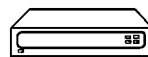

## Connecting Headphones (depending on the model)

ENG

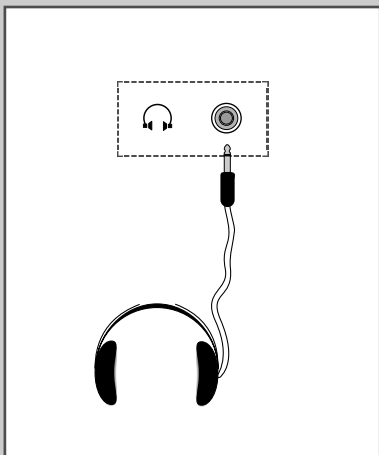

*You can connect a set of headphones to your television if you wish to watch a television programme without disturbing the other people in the room.*

- 1 Plug a set of headphones into the 3.5 mm mini-jack socket of the television.

**Result:** The sound is heard through the headphones.

- 2 When you wish to hear the sound through the speakers again, simply disconnect the headphones.

➤ Prolonged use of headphones at a high volume may damage your hearing.

## Viewing Pictures From External Sources



*Once you have connected up your various audio and video systems, you can view the different sources by selecting the appropriate input.*

- 1 Check that all the necessary connections have been made.
- 2 Switch the television on and if necessary, press the **VIDEO** button one or more times until the required input is displayed.

➤ Depending on the source selected, the pictures may appear automatically.

➤ To watch television programmes again, press the **TV** button and select the number of the channel required.

## Automatic Degaussing to Remove Colour Patches

ENG

*A degaussing coil is mounted around the picture tube, so you do not normally need to degauss the television manually.*

*If you move the television to a different position and color patches appear on the screen, you must:*

- ◆ Switch the television off by pressing the "⓪" (ON/OFF) button on the front panel
- ◆ Unplug the television from the wall socket
- ◆ Leave the television power-off (stand-by) for about 30 minutes so that the automatic degauss function can be activated, and then press the POWER ⏻ button on the remote control.

👉 *If your television will be left unattended, press the "⓪" (ON/OFF) button to turn your television off.*

## Troubleshooting: Before Contacting Service Personnel

*Before contacting Samsung after-sales service, perform the following simple checks.*

*If you cannot solve the problem using the instructions below, note the model and serial number of the television and contact your local dealer.*

No sound or picture	<ul style="list-style-type: none"><li>◆ Check that the mains lead has been connected to a wall socket.</li><li>◆ Check that you have pressed the "⓪" (ON/OFF) button.</li><li>◆ Check the picture contrast and brightness settings.</li><li>◆ Check the volume.</li></ul>
Normal picture but no sound	<ul style="list-style-type: none"><li>◆ Check the volume.</li><li>◆ Check whether the <b>MUTE</b> ⏻ button has been pressed on the remote control.</li></ul>
No picture or black and white picture	<ul style="list-style-type: none"><li>◆ Adjust the colour settings.</li><li>◆ Check that the broadcast system selected is correct.</li></ul>
Sound and picture interference	<ul style="list-style-type: none"><li>◆ Try to identify the electrical appliance that is affecting the television and move it further away.</li><li>◆ Plug your television into a different mains socket.</li></ul>
Blurred or snowy picture, distorted sound	<ul style="list-style-type: none"><li>◆ Check the direction, location and connections of your aerial. This interference is often due to the use of an indoor aerial.</li></ul>
Remote control malfunctions	<ul style="list-style-type: none"><li>◆ Replace the remote control batteries.</li><li>◆ Clean the upper edge of the remote control (transmission window).</li><li>◆ Check the battery terminals.</li></ul>

---

## **- AFTER SALES SERVICE**

---

- Do not hesitate to contact your retailer or service agent if a change in the performance of your product indicates that a faulty condition may be present.

