

EMC[®]

GLOBAL MACHINERY COMPANY

INSTRUCTION MANUAL

REDEYE[®]

**2000W 250mm (10")
Table Saw**

*with Laser Line Generator**



* Patent Pending

• Melbourne • Perth • Auckland • Hong Kong • Shanghai
• Taipei • New York • Verona • London • Paris

LS250TS

061004 E08 DCR

Contents

Warranty	2
Introduction	3
Environmental protection	3
Warnings	3
Description of symbols	3
Specifications	3
Safety rules for laser lights	4
General safety instructions	4
Additional safety rules for table saws	5
Unpacking	7
Required Tools	7
Components	8
Know your product	9
Assembly	10
Stand set-up	10
Attaching the wheel axle	11
Attaching the wheels	11
Fitting and adjusting the rear extension table	11
Attaching the height adjustment handle	11
Fitting the riving knife and laser assembly	11
Fitting the blade guard	12
Using the mitre gauge holder	12
Using the push stick holder	12
Folding the stand	13
Moving the saw	13
Adjusting the laser line	13
Switching on and off	14
Adjusting the cutting depth	14
Adjusting the blade angle	14
Using the rip fence	14
Using the mitre gauge	15
Operation	15
Push sticks	15
Kickback	15
Tips to avoid kickback	16
Making longitudinal cuts	16
Cutting a narrow workpiece	16
Cutting an extremely narrow workpiece	17
Making bevel cuts	17
Making cross cuts	17
Replacing the saw blade	17
Changing the batteries of the laser generator	18
Maintenance	18
Power cord maintenance	18
Cleaning	18
General inspection	18

Warranty Power Tools

Whilst every effort is made to ensure your complete satisfaction with this tool, occasionally, due to the mass manufacturing techniques, a tool may not live up to our required level of performance and you may need the assistance of our service department.

This product is warranted for a 2-year period for home domestic use from the date of the original purchase. If found to be defective in materials or workmanship, the tool or the offending faulty component will be repaired or replaced free of charge with another of the same item.

A small freight charge may apply. Proof of purchase is essential. We reserve the right to reject any claim where the purchase cannot be verified.

This warranty does not include damage or defects to the tool caused by or resulting from abuse, accidents, alterations or commercial or business use. It also does not cover any bonus items or included accessories. Only the power tool is covered under this warranty.

With continuing product development, changes may have occurred which render the product received slightly different to that shown in this instruction manual.

Please ensure that you store your receipt in a safe place. Conditions apply to the above warranty. For full details of the warranty terms and conditions please refer to our website – www.gmcompany.com

For prompt service we suggest you log your service request online - www.gmcservice.com.au, should you not have access to the internet, please contact our service department on 1300 880 001 (Australia) or 0800 445 721 (New Zealand).

Introduction

Your new GMC power tool will more than satisfy your expectations. It has been manufactured under stringent GMC Quality Standards to meet superior performance criteria.

You will find your new tool easy and safe to operate, and, with proper care, it will give you many years of dependable service.

CAUTION. Carefully read through this entire Instruction Manual before using your new GMC Power Tool. Take special care to heed the Cautions and Warnings.

Your GMC power tool has many features that will make your job faster and easier. Safety, performance, and dependability have been given top priority in the development of this tool, making it easy to maintain and operate.

Environmental protection



Recycle unwanted materials instead of disposing of them as waste. All tools, hoses and packaging should be sorted, taken to the local recycling centre and disposed of in an environmentally safe way.

Warnings

1. It may be more difficult to see the laser line in conditions of bright sunshine and on certain surfaces.
2. When storing the tool, remove the batteries in case of leakage.
3. Batteries or damage due to leaking batteries are not covered under warranty.

Symbols

The rating plate on your tool may show symbols. These represent important information about the product or instructions on its use.



Wear eye protection.

Wear hearing protection.

Wear breathing protection.



N380

Conforms to EMC regulations..

Specifications

Voltage:	230–240Vac ~ 50Hz
Input power:	2000W
No load speed:	5800min ⁻¹
Blade diameter:	250mm
Blade bore size:	16mm
Blade teeth:	24
Table size:	660mm x 440mm
Side extension table sizes:	130mm x 440mm with 150mm slide capacity
Rear extension table size:	660mm x 130mm
Table height:	880mm
Depth of cut at 90°:	75mm
Depth of cut at 45°:	45mm
Laser class:	1
Laser wavelength:	650nm
Laser output power:	≤ 1Mw

Safety rules for laser lights

The laser light/laser radiation used in the GMC REDEYE® system is Class 1 with maximum 1mW power and 650nm wavelengths. These lasers do not normally present an optical hazard, although staring at the beam may cause flash blindness.

Warning. Do not stare directly at the laser beam. A hazard may exist if you deliberately stare into the beam, please observe all safety rules as follows;

- The laser shall be used and maintained in accordance with the manufacturer's instructions.
- Never aim the beam at any person or an object other than the work piece.



- The laser beam shall not be deliberately aimed at personnel and shall be prevented from being directed towards the eye of a person for longer than 0.25s.
- Always ensure the laser beam is aimed at a sturdy work piece without reflective surfaces. i.e. wood or rough coated surfaces are acceptable. Bright shiny reflective sheet steel or the like is not suitable for laser use as the reflective surface could direct the beam back at the operator.
- Do not change the laser light assembly with a different type. Repairs must only be carried out by the laser manufacturer or an authorised agent.

Caution. Use of controls or adjustments or performance of procedures other than those specified herein may result in hazardous radiation exposure.

Please refer to the relevant Australian standards, AS 2397 and AS/NZS2211 for more information on Lasers.

General safety instructions

To use this tool properly, you must observe the safety regulations, the assembly instructions and the operating instructions to be found in this Manual. All persons who use and service the machine have to be acquainted with this Manual and must be informed about its potential hazards. Children and infirm people must not use this tool. Children should be supervised at all times if they are in the area in which the tool is being used. It is also imperative that you observe the accident prevention regulations in force in your area. The same applies for general rules of occupational health and safety.

Warning. When using power tools, basic safety precautions should always be taken to reduce the risk of fire, electric shock and personal injury. Also, please read and heed the advice given in the additional important safety instructions.

- 1. Keep the work area clean and tidy.** Cluttered work areas and benches invite accidents and injury.
- 2. Consider the environment in which you are working.** Do not use power tools in damp or wet locations. Keep the work area well lit. Do not expose power tools to rain. Do not use power tools in the presence of flammable liquids or gases.
- 3. Keep visitors away from the work area.** All visitors and onlookers, especially children and infirm persons, should be kept well away from where you are working. Do not let others in the vicinity make contact with the tool or extension cord.
- 4. Store tools safely.** When not in use, tools should be locked up out of reach.
- 5. Do not force the tool.** The tool will do the job better and safer working at the rate for which it was designed.
- 6. Use the correct tool for the job.** Do not force small tools or attachments to do the job best handled by a heavier duty tool. Never use a tool for a purpose for which it was not intended.

- 7. Dress correctly.** Do not wear loose clothing or jewellery. They can be caught in moving parts. Rubber gloves and non-slip footwear are recommended when working outdoors. If you have long hair, wear a protective hair covering.
- 8. Use safety accessories.** Safety glasses and earmuffs should always be worn. A face or dust mask is also required if the sanding operation creates dust.
- 9. Do not abuse the power cord.** Never pull the cord to disconnect the tool from the power point. Keep the cord away from heat, oil and sharp edges.
- 10. Secure the work piece.** Use clamps or a vice to hold the work piece. It is safer than using your hand and frees both hands to operate the tool.
- 11. Do not overreach.** Keep your footing secure and balanced at all times.
- 12. Look after your tools.** Keep tools sharp and clean for better and safer performance. Follow the instructions regarding lubrication and accessory changes. Inspect tool cords periodically and, if damaged, have them repaired by an authorised service facility. Inspect extension cords periodically and replace them if damaged. Keep tool handles dry, clean and free from oil and grease.
- 13. Disconnect idle tools.** Switch off the power and disconnect the plug from the power point before servicing, when changing accessories and when the tool is not in use.
- 14. Remove adjusting keys and wrenches.** Check to see that keys and adjusting wrenches are removed from the tool before switching on.
- 15. Avoid unintentional starting.** Always check that the switch is in the OFF position before plugging in the tool to the power supply. Do not carry a plugged in tool with your finger on the switch.
- 16. Use outdoor rated extension cords.** When a tool is used outdoors, use only extension cords that are intended for outdoor use and are so marked.

- 17. Stay alert.** Watch what you are doing. Use common sense. Do not operate a power tool when you are tired.
- 18. Check for damaged parts.** Before using a tool, check that there are no damaged parts. If a part is slightly damaged, carefully determine if it will operate properly and perform its intended function. Check for alignment of moving parts, binding of moving parts, breakage of parts, proper mounting and any other conditions that may affect the operation of the tool. A part that is damaged should be properly repaired or replaced by an authorised service facility, unless otherwise indicated in this Instruction Manual. Defective switches must be replaced by an authorised service facility. Do not use a tool if the switch does not turn the tool on and off correctly.
- 19. Guard against electric shock.** Prevent body contact with grounded objects such as water pipes, radiators, cookers and refrigerator enclosures.
- 20. Use only approved parts.** When servicing, use only identical replacement parts. Use an authorised service facility to fit replacement parts.

Additional safety rules for table saws

- Always pull the plug out of the power socket before adjusting or servicing the machine.
- Give these safety regulations to all persons who work on the machine.
- Do not use this saw to cut firewood.
- Caution! Hands and fingers may be injured on the rotating saw blade.
- Before you use the machine for the first time, check that the voltage marked on the rating plate is the same as your mains voltage.
- If you need to use an extension cable, make sure its conductor cross-section is large enough for the saw's power consumption. Minimum cross-section: 1.0mm².
- Do not use or leave the saw in the rain and never use it in damp, humid, or wet conditions.

- *Provide good lighting.*
- *Never saw near combustible liquids or gases.*
- *Wear suitable work clothes! Loose garments or jewellery may become caught up in the rotating saw blade.*
- *Operators have to be at least 18 years of age. Trainees of at least 16 years of age are allowed to use the machine under supervision.*
- *Keep children and infirm people away from the machine when it is connected to the power supply.*
- *Check the power cord. Never use a faulty or damaged power cord.*
- *If the cordset is damaged take the saw to an authorised service centre for repair or replacement*
- *Never attempt any repairs yourself, always take it to an authorised service centre for repair or parts replacement.*
- *Keep the saw table and your workplace clean of wood scrap and any unnecessary objects.*
- *Keep the area free of tripping hazards.*
- *Persons working with the machine should not be distracted.*
- *Note the direction of rotation of the motor and saw blade.*
- *After you have switched off the motor, never slow down the saw blade by applying pressure to its side.*
- *Fit only blades which are well sharpened and have no cracks or deformations.*
- *The machine is to be operated only with a saw blade from a reputable supplier.*
- *Faulty saw blades have to be replaced immediately.*
- *Never use saw blades, which do not comply with the data specified in this manual.*
- *Make sure that the arrow on the saw blade complies with the arrow marked on the machine.*
- *Never dismantle the machine's safety devices or put them out of operation.*
- *Damaged or faulty safety devices have to be replaced immediately.*
- *Never cut a work piece, which is too small to hold securely.*
- *If you are interrupted when operating the saw, complete the process and switch off before looking up.*
- *Periodically check that all nuts, bolts and other fixings are properly tightened.*
- *Do not store materials or equipment above a machine in such a way that they could fall into it.*
- *Always ensure that your work is on the table. Never use the tool to cut pieces that are not on the table.*
- *Do not place your hands in awkward positions where one or both may slip suddenly and touch the saw blade.*
- *When working with a long work piece, use an additional support such as a saw table to prevent the blade from grabbing the work.*
- *When cutting round wood, use clamps that prevent the work piece from turning on the table.*
- *There must be no nails or other foreign bodies in that part of the work piece you want to cut.*
- *Always stand to the side of the saw blade when working with the saw.*
- *Never load the machine so much that it slows down and over-heats.*
- *Never saw several work pieces simultaneously.*
- *Use the push stick provided with the tool when cutting along or across narrow work pieces.*
- *Never remove loose splinters, chips or jammed pieces of wood when the saw blade is running.*
- *To rectify faults or remove jammed pieces of wood, always switch off the machine first and remove the mains plug!*
- *Adjustments, measurements and cleaning jobs are to be performed only when the motor is switched off and the mains plug removed!*

- Before you switch on the machine, check that all wrenches and adjustment tools have been removed.
- When you leave your workplace, switch off the motor and pull out the power plug.
- All guards and safety devices have to be refitted immediately after completion of any repairs or maintenance.
- It is imperative to observe the accident prevention regulations in force in your area as well as all other generally recognised rules of safety.
- The machine may be used in closed room only in conjunction with a suitable vacuum extraction system.
- This table saw must be connected to a 230–240V socket-outlet with a minimum 10A circuit.
- Never use the cord for any purpose other than that for which it is intended!
- Adopt a firm standing position and keep your balance at all times.
- Check the tool for signs of damage!
- Before you use the tool it is imperative to check that its safety devices and any slightly damaged parts are working properly and in the way intended.
- Check that the moving parts work properly and do not jam or whether any of the parts are damaged. All parts must be fitted correctly and satisfy all conditions for the tool to work properly.
- Unless otherwise stated in these instructions, damaged safety devices and parts must be repaired or replaced by an authorised service facility.
- Have damaged switches replaced by an authorised service facility.

- This tool complies with the pertinent safety regulations. Repairs are to be carried out only by qualified electricians at authorised service centres, using original replacement parts. The user may suffer an accident if this condition is not observed.
- Rebating or grooving should not be carried out unless suitable guarding, such as a tunnel guard, is fitted above the table saw.
- Saws shall not be used for slotting (stopped groove).

Wear goggles • Wear earmuffs • Wear a breathing mask

Unpacking

Due to modern mass production techniques, it is unlikely that your GMC Power Tool is faulty or that a part is missing. If you find anything wrong, do not operate the tool until the parts have been replaced or the fault has been rectified. Failure to do so could result in serious personal injury.

1. Remove all loose parts from the carton.
2. Remove the packing materials from around the saw.
3. Carefully lift the saw from the carton and place it on a level work surface.

Required Tools

The following tools (not supplied) are required to assemble and maintain the table saw

- 18mm spanner
- 13mm spanner
- Phillips head screwdriver

Components

The GMC LS250TS table saw is supplied with the following components:

1. Table saw
2. Riving knife and laser assembly
3. Blade guard
4. Wheels x2
5. Hubcaps x2
6. Rip fence
7. Mitre gauge
8. Push stick
9. Spanner
10. Left hand side extension table
11. Rear extension table
12. Height adjustment handle with hex screw, swivel tube and washer
13. 5mm Hex key
14. Wheel axle
15. AAA batteries x2
16. 2 x 13mm Hex head screws with 4 flat washers and 2 spring washers for securing wheels to axle (already fitted on axle)
17. 10 x ST4.2 x 13mm Philips head screws with 10 flat washers for securing hub caps to wheels
18. 4 x ST4.2 x 9mm set screws for securing side extension tables (already fitted to extension table rods)

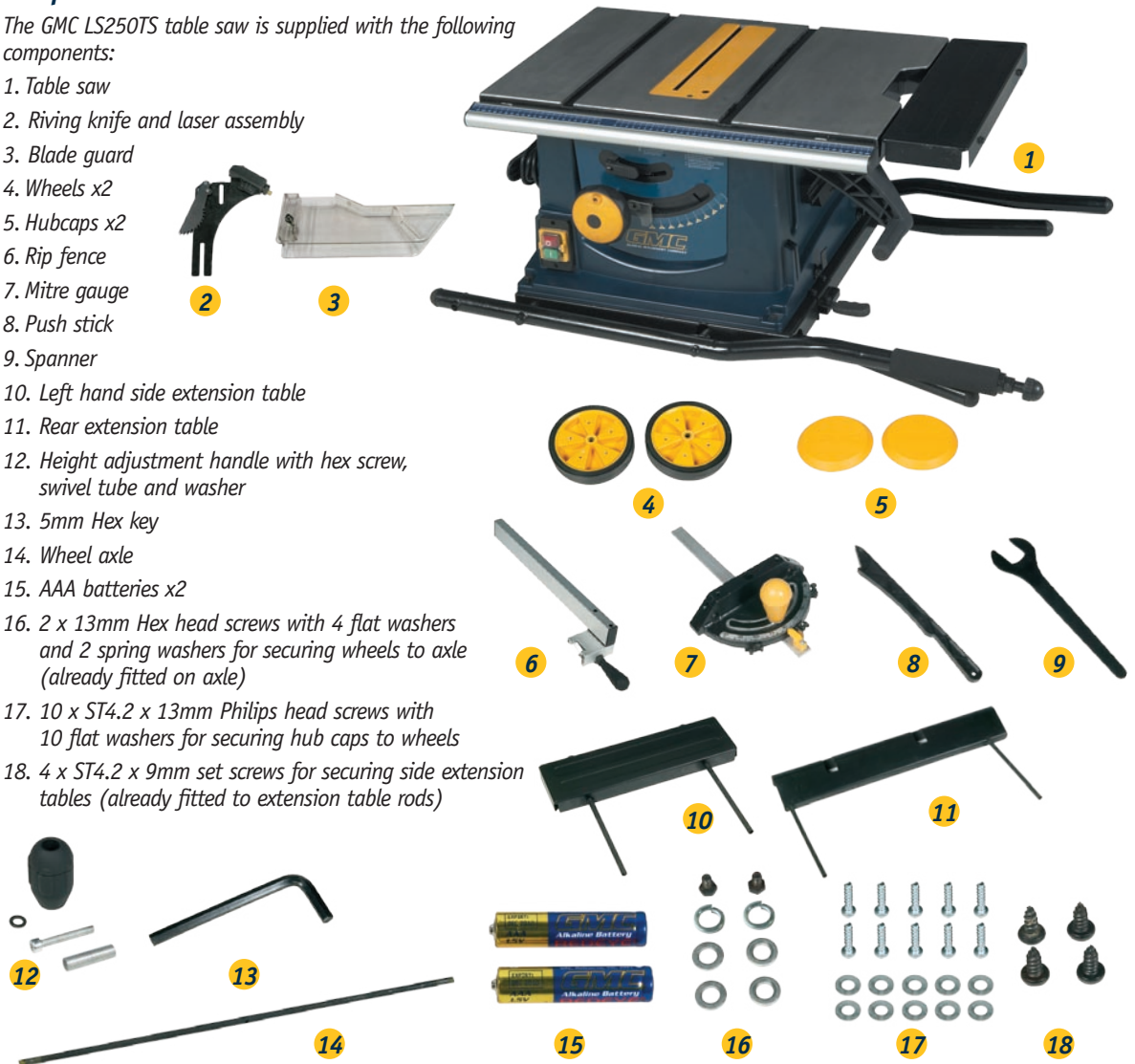

Know your product

1. Table top
2. On/off switch
3. Cable storage
4. Handle for tilting table saw (Upper)
5. Handle for tilting table saw (Lower)
6. Mitre gauge holder
7. Spare blade holder
8. Riving knife
9. Laser assembly
10. Laser adjustment screw (x2)
11. Laser battery compartment screw (x2)
12. Table insert
13. Rip fence
14. Rip fence locking lever
15. Rip fence scale
16. Mitre gauge
17. Mitre gauge locking knob
18. Blade guard
19. Blade height adjustment handle
20. Blade angle wheel
21. Blade angle pointer
22. Blade angle scale
23. Blade lock
24. Rear extension table
25. Side extension table (x2)
26. Side extension table locking knob (x4)
27. Stand assembly
28. Stand locking lever
29. Wheel
30. Wheel hubcap
31. Adjustable foot
32. Saw blade
33. Push stick
34. Push stick storage
35. Push stick storage

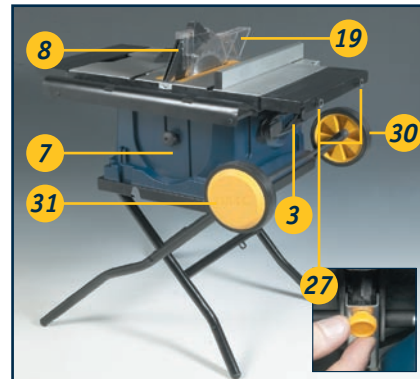
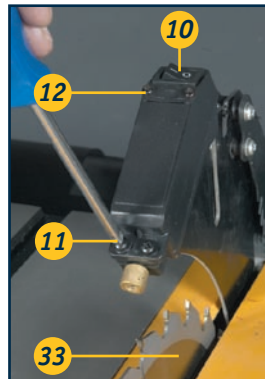
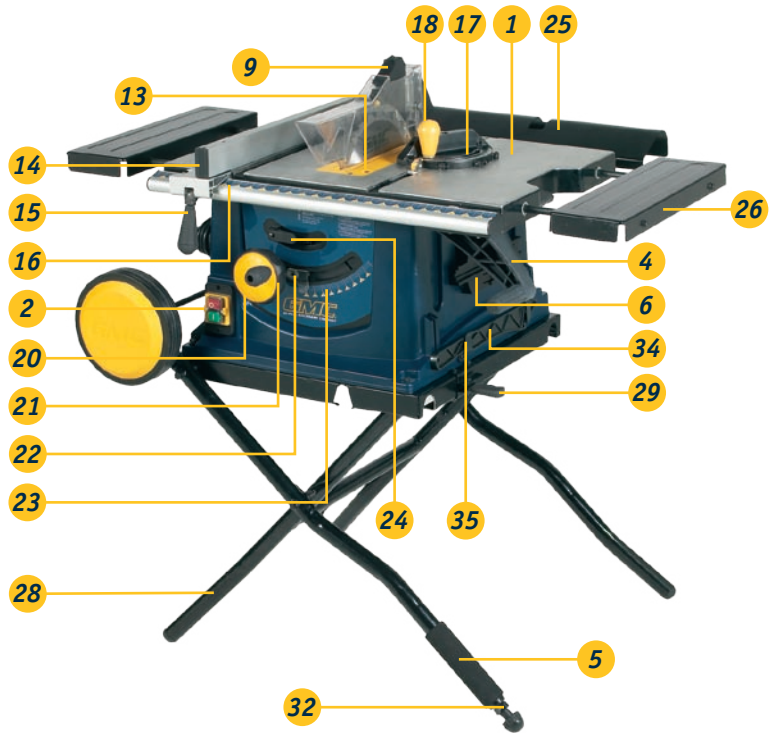

Assembly

Stand set-up

1. Place the table saw on the floor (fig A).
2. On the left hand side extension table which was packed separately from the table saw remove the 2 self-tapping screws from the end of each rod.
3. Fit the left hand side extension table into the 2 positioning holes on the left hand side of the table saw, the extension table locking knobs (28) may need to be loosened if it is a tight fit (fig B).

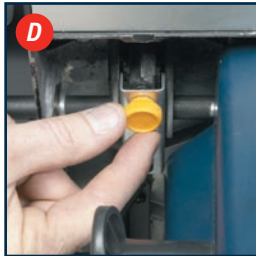
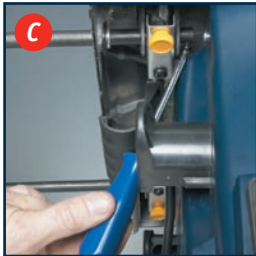
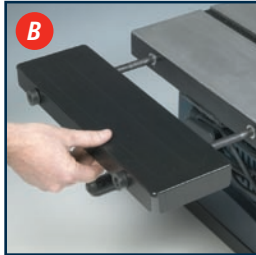

4. Replace the 2 self-tapping screws to prevent the side extension table from sliding out (fig C).
Note: The guide rods can be rotated slightly to gain access to the screw holes.
5. Ensure the left hand side extension table is fully inserted and tighten the extension table locking knobs to secure it in position (fig D).
6. Using the handle on the table saw (4) and the soft grip handle on the lower leg (5) gently tilt

the table saw onto its left hand side.

7. Push the stand locking lever (29) to the left to disengage the stand assembly and fold open the stand legs (fig E).
8. Fully open the stand legs and ensure that the stand locking lever clicks back into place indicating that the stand legs are securely open (fig F).
9. Using the handle on the table saw (4) and the soft grip handle on the lower leg (5) tilt the table saw onto its stand (fig G).

Important. Use both handles when tilting the table onto the stand. Push down on the leg handle (5) and pull the table handle (4).

10. Loosen the lock nut on the adjustable foot (32) and screw the foot in or out until the table saw is stable (fig H & I).
11. Tighten the lock nut.

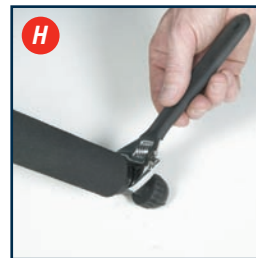

Attaching the wheel axle

1. Remove the retaining bolts and washers from the ends of the axle.
2. Slide the wheel axle through the holes in the 2 stand legs on the left hand side of the table saw (fig J).



Attaching the wheels

1. Fit the flat washer (fig K) followed by the wheel, flat washer and the spring washer onto the axle (fig L). Secure the wheel onto the axle using the 13mm hex head screw.
2. Repeat for the opposite side.
3. Position the hubcap over the wheel (fig M) and secure from behind using 5 of the ST4.2 x 13mm Philips head screws with flat washers (fig N).
4. Repeat for the opposite side.



Fitting and adjusting the rear extension table

1. Remove the 2 self-tapping screws from the end of each rod on the rear extension table (25).
2. Fit the rear extension table into the 2 positioning holes on the back of the table saw (fig O).
3. Replace the 2 self-tapping screws in each rod to prevent the rear extension table from sliding out.



Attaching the height adjustment handle

1. Fit the blade height adjustment handle (20) onto the blade angle wheel (21) by first placing the metal handle tube onto the handle screw.
2. Place the screw and tube through the handle, and then fit the washer onto the thread of the screw.
3. Fit the thread of the screw into the thread on the yellow insert of the blade angle wheel (21) and tighten the screw firmly with a 5mm hex key supplied (fig P).



Note. The flat washer should be fitted between the handle (20) and the yellow insert of the blade angle wheel (21).

Fitting the riving knife and laser assembly

1. Remove the screw securing the table insert (13) and take off the table insert (fig Q).

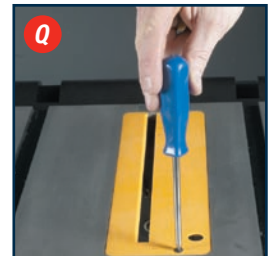

2. Using a 13mm spanner (not supplied) loosen the hex bolt on the riving knife clamp (fig R) and insert the riving knife between the metal plate and the clamp block (fig S).



3. Loosen the blade lock (24) by lifting it up (fig T) and turn the blade height adjustment handle (20) to raise the blade to its highest position (fig U).



4. Tighten the blade lock (24) by pushing it back down towards the table saw.

5. Adjust the height of the riving knife so that the gap between the knife and the teeth of the blade is even along the curve of the blade and is not more than 5mm.



6. Tighten the hex bolt to secure the riving knife in place.

7. Replace the table insert (13).

Fitting the blade guard

1. Remove the nut, screw and 2 washers from the blade guard.

2. Fit the blade guard onto the top of the riving knife ensuring that the slot in the blade guard lines up with the slot in the riving knife.



3. Fit one flat washer onto the screw and place the screw through the blade guard, riving knife and blade guard again.

4. Fit the second flat washer onto the end of the screw followed by the nut.



5. Tighten the nut to secure the blade guard in position (Fig V) but do not overtighten as this will prevent the blade guard from moving up and down freely as the workpiece passes below it.

Using the mitre gauge holder

1. The table saw features a mitre gauge holder on the right hand side of the housing.

2. Slide the mitre gauge into the holder until it clicks into place and is secure in the holder (fig W).

3. To remove the miter gauge depress and hold both latches on the holder and pull out the mitre gauge.

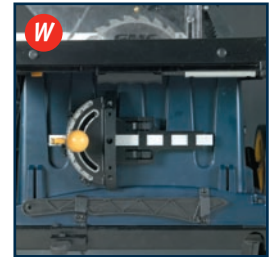

Using the push stick holder

1. The table saw features a push stick holder on the right hand side of the housing.

2. To insert the push stick place the tip of the push stick into the bracket on the right hand side.

3. Lower the handle and rest it on the bracket on the left hand side (Fig W).

Folding the stand

1. Wrap the cordset around the cable storage (3) to keep the cord out of the way (fig X).
2. Ensure the left hand side extension table is full inserted and secured with the side extension table locking knobs (27).
3. Using the handle on the table saw (4) and the soft grip handle on the lower leg (5) gently tilt the table saw onto its left hand side so it is resting on the wheels and rubber stops of the left hand extension table (fig Y).
4. Push the stand locking lever (29) to the left to disengage the stand assembly (fig Z).
5. Fold the stand legs and ensure that the stand locking lever clicks back into place indicating that the stand legs are securely locked in position.

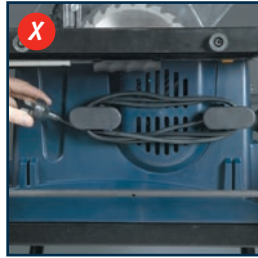

Moving the saw

1. Ensure that the blade is lowered beneath the level of the table top.
2. Fold the stand as explained in the previous section.
3. Use the 2 legs to move the table saw to its new position (fig a).



Adjusting the laser line

1. To adjust the laser beam first take a piece of accurately square cut wood approximately 100mm wide and 300mm long. Draw a line parallel to a long edge approximately 10mm from the edge.
2. Set the mitre gauge (17) at 0° (at right angles to the blade) and hold the short edge of the wood against the mitre gauge.
3. Keeping the wood parallel to the blade with the use of the mitre fence, move the wood so that the teeth of the blade touch the marked line.
4. Switch on the laser with the laser on/off switch (10).
5. If the laser line is not accurate adjust as follows.

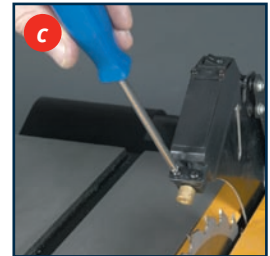

6. Loosen and remove the screw securing the blade guard onto the riving knife (fig b).
7. Lift the blade guard off the riving knife.
8. Loosen the two laser adjustment screws (11) on the laser assembly (fig c).
9. Rotate and move the laser assembly from side to side until the laser line is aligned with the marked line on the piece of wood (fig d).

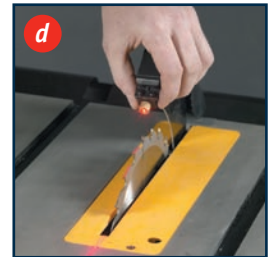

Note. You can adjust the laser line so that it is just to one side of the cut or so that it is centred on the cut, depending on how you wish to use the laser line when cutting.

10. Tighten the 2 laser adjustment screws (11).
11. Check the adjustment and readjust if necessary

Switching on and off

1. To turn the table saw ON, press the green push button (fig e).
2. To turn the table saw OFF, press the red push button (fig f).

Note. This saw is fitted with an electromagnetic switch. In the case where the power supply is turned off to the saw, the saw must be turned on by pressing the green ON button after the power supply is reconnected.

Adjusting the cutting depth

Warning. The blade lock (24) must be loosened before the blade height is adjusted, and re-tightened once the desired setting is reached.

1. Set the saw blade to the required cutting depth by turning the blade height handle (20) (fig g).
2. Turning the wheel anti-clockwise increases the cutting depth.



3. Turning the wheel clockwise decreases the cutting depth.

Adjusting the blade angle

1. Loosen the blade lock (24) and turn the blade angle wheel (21) until the pointer (22) points to the required angle on the scale (23) (fig h).
2. The blade angle pointer (22) can be adjusted when checking the accuracy of the blade angle. With the power disconnected, place a set square against the saw blade. Adjust the blade angle wheel until the blade is parallel to the set square then move the pointer to 0° on the blade angle scale.



Using the rip fence

1. Use the rip fence when making longitudinal cuts.
2. The rip fence (14) can be fitted to either side of the table top (1). In order to use the rip fence scale (16), move the fence up to the blade and take a measurement on the scale. Now move the fence away from the blade. The difference in measurements will be equivalent to the width of cut. It is necessary to make a trial cut, measure the workpiece and re-adjust the rip fence in order to establish accurate datum levels.
3. Lift the rip fence locking lever (15) and slide the fence to the required position (fig i).
4. Retighten the fence locking lever (15).



Using the mitre gauge

1. Slide the mitre gauge (17) into the slot of the table top (1) (fig j).
2. Loosen the locking knob (18) on the mitre gauge (fig k).
3. Rotate the mitre gauge to select the required angle.
4. Re-tighten the locking knob.

Operation

Your table saw can be used to make a variety of cuts including longitudinal cuts, bevel cuts and mitre cross cuts. The below section defines a common list of table saw terms:

Through Sawing. Any cutting operation where the blade extends completely through the thickness of the workpiece.

Non-Through Sawing. Any cutting operation where the blade does not extend through the workpiece.

Rip Cut. A cutting or shaping operation made along the length or grain of the workpiece.

Cross Cut. A cut or shaping operation made across the width of the workpiece cutting the workpiece to length.

Freehand. Performing a cut without a fence, mitre gauge, fixture, hold down or other proper device to keep the workpiece from twisting during the cut.

Kickback. An uncontrolled grabbing and throwing of the workpiece back toward the front of the saw.

Anti-Kickback Pawls. A device, which when properly maintained is designed to stop the workpiece from being kicked back at the operator during operation.

Riving Knife. Also known as a separator or spreader. The riving knife is a metal piece slightly thinner than the saw

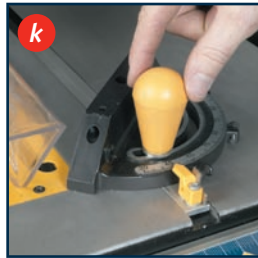

blade which helps keep the kerf open during cutting operations and prevents kickback.

Push Stick. A device used to feed the workpiece through the saw during narrow ripping-type operation and helps keep the operator's hands well away from the blade.

Push Block. A device used for ripping-type operations too narrow to allow use of a push stick.

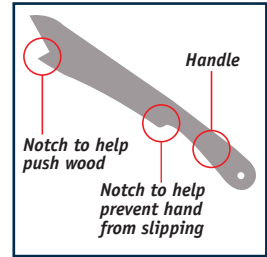

Push sticks

A push stick should always be used if your hand gets within 125mm (5") of the saw blade. A push stick is a safety device that helps to keep your hands and fingers away from the saw blade. A handle helps to apply pressure to the workpiece whilst a notch at the front of the push stick fits onto the edge of the wood to help push it through the saw. A push stick can be easily made from a scrap piece of material. The push stick must be narrower than the workpiece. Please refer to the diagram which depicts a push stick.

Kickback

Kickback occurs when the blade stalls or binds, kicking the workpiece back towards the front of the saw. Kickback can cause serious injury. Precautions must be taken to avoid kickback. The following conditions can cause kickback and should be avoided.

- Making a cut with the incorrect blade depth
- Attempting to saw through knots or nails in the workpiece
- Twisting the wood while making a cut
- Failing to correctly position the riving knife
- Making a cut with a dull, gummed-up or improperly set blade.

- Failing to support large workpieces
- Forcing the workpiece through the saw blade
- Cutting warped or wet lumber
- Not following correct operating procedures
- Failing to use the anti-kickback pawls
- Using the wrong blade for the type of cut

Tips to avoid kickback

1. Always use the correct blade depth setting. The top of the blade teeth should clear the workpiece by 3mm to 6mm.
2. Inspect the workpiece for knots or nails before beginning a cut. Knock out any loose knots with a hammer. Never saw into a loose knot or nail.
3. Make straight cuts.
Always use the rip fence when rip cutting. This helps prevent twisting the wood in the cut.
4. Always use clean, sharp, properly-set blades. Never make a cut with a dull blade.
5. To avoid pinching the blade, support the workpiece properly before beginning a cut.
6. When making a cut, use steady, even pressure. Never force a cut.
7. Do not cut wet or warped lumber.
8. Always hold your workpiece firmly with both hands or use push blocks, push sticks, and feather boards to keep your body in a balanced position to be able to resist kickback should it occur.
9. Use the right type of blade for the cut being made.



Making longitudinal cuts

Important. After each new adjustment it is advisable to carry out a trial cut in order to check the set dimensions.

After switching on the saw, wait for the blade to reach its maximum speed of rotation before commencing with the cut. Take extra care when starting the cut.

1. Longitudinal cuts involve cutting through a workpiece along its full length.
2. One edge of the workpiece is pressed against the rip fence while its flat side rests on the table top.
3. The saw blade guard must always be operational and cover the workpiece.
4. When making longitudinal cuts you must always stand to one side of the cutting line.
5. Set the fence to suit the required width using the laser line as a guide.
6. Switch on the table saw.
7. With your fingers together, place your hands flat on the workpiece and push the workpiece along the fence into the saw blade.
8. Guide the workpiece at the side with your left hand only as far as the front edge of the guard hood.
9. Always push the workpiece through to the end of the riving knife.
10. Leave the off-cuts on the saw table until the saw blade has stopped again.
11. Secure a long workpiece against sagging at the end of the cutting operation (e.g. with a roller stand or similar device)
12. Use the push stick (34) for guiding the workpiece if your hand gets to within 125mm (5") of the saw blade.
13. After using the push stick (34), return place it back on the holder (35).

Cutting a narrow workpiece

Longitudinal cuts in a workpiece smaller than 125mm (5") in width must always be made with the help of the push stick (34). **Warning.** Worn or damaged push sticks must be replaced immediately.

Cutting an extremely narrow workpiece

Longitudinal cuts in an extremely narrow workpiece with a width of 30mm or less must always be made with the help of a push block.

This table saw is not supplied with a push block. (Either make or purchase a suitable one from a specialist dealer).

Warning. Worn push blocks must be replaced without delay.

Making bevel cuts

1. Always use the fence when cutting bevels.
2. Set the saw blade to the required angle using the blade angle wheel (21).
3. Set the fence to suit the width and height of the workpiece using the laser line as a guide.
4. Carry out the cut in accordance with the workpiece width.

Making cross cuts

Warning. When cross cutting, do not use the rip fence (14) as a length stop as the cut off piece could bind between the fence and the blade and cause kickback.

1. Push the mitre gauge (17) into one of the two slots of the table saw and set it to the required angle. If you also want to set the saw blade at an angle, use the slot, which prevents your hand and the mitre gauge coming into contact with the saw blade.
2. Press the workpiece firmly against the mitre gauge.
3. Switch on the saw.
4. Push the mitre gauge and the workpiece toward the saw blade in order to make the cut.

Important. Always hold the guided part of the workpiece. Never hold that part of the workpiece, which is being cut off. Always push the mitre gauge far enough forward for the workpiece to be cut through completely.

5. Switch off the saw again.
6. Wait for the saw blade to stop before removing the off-cuts.

Replacing the saw blade

Warning. Switch off the table saw and remove the mains power plug before carrying out any adjustments, maintenance work or blade changes. Wear work gloves when handling or fitting the blade.

1. Loosen the blade lock (24) (fig l) and turn the blade height handle (20) (fig m) until the saw blade is at its maximum height.
2. Loosen and remove the screw securing the table insert (13).
3. Take out the table insert (13).
4. Remove the riving knife (8) (fig n).
5. Use the spanner supplied to lock the spindle in position (fig o).
6. Use an 18mm open-ended spanner (not supplied) to undo the blade bolt by turning it in an anti-clockwise direction (right-hand thread) (fig p).

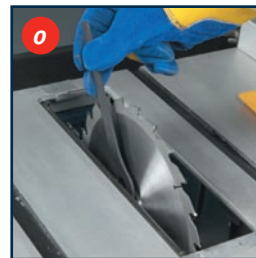

7. Take off the outer flange and remove it and the saw blade (fig q).
8. Carefully clean the saw blade flanges before fitting the new blade.
9. Insert and secure the saw blade in reverse order.

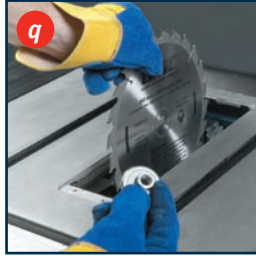

Caution. Take note of the direction of blade rotation. The cutting edge of the teeth must point in the running direction, i.e. forward (refer to the arrow on the saw blade).

10. Re-fit and re-set the riving knife and the saw blade guard.
11. Before using the saw again, check that all safety devices are in good working order.

Important. After replacing the saw blade, make sure the saw blade runs freely by turning the blade by hand.

12. Plug the machine into a mains socket and run the saw at no load before using it to cut any materials.

Changing the batteries of the laser generator

Warning. Switch off the machine and remove the mains power plug before carrying out any adjustments, maintenance work or blade changes.

1. Set the height of the blade to its maximum.
2. Remove the blade guard (19).
3. Loosen the two screws (12) at the top of the laser assembly (fig r), turn the securing tabs to

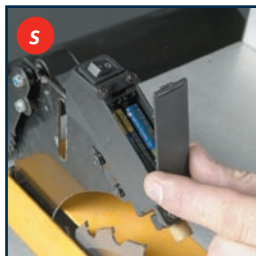

the side and remove the laser battery cover (fig s). Take out the two batteries.

4. Replace both batteries with the same type (or equivalent), taking care to insert them the same way round as the old batteries (fig t).
5. Replace the battery cover.
6. Check and if necessary, adjust the laser line.



Maintenance

Warning. Always ensure that the tool is switched off and the plug is removed from the power point before making and adjustments or maintenance procedures.

Power cord maintenance

If the supply cord needs replacing, the task must be carried out by the manufacturer, the manufacturer's agent, or an authorised service centre in order to avoid a safety hazard.

Cleaning

1. Keep the tool's air vents unclogged and clean at all times.
2. Remove dust and dirt regularly. Cleaning is best done with a soft brush or a rag.
3. Re-lubricate all moving parts at regular intervals.
4. Never use caustic agents to clean plastic parts.

Caution. Do not use cleaning agents to clean the plastic parts of the saw. A mild detergent on a damp cloth is recommended.

General inspection

Regularly check that all the fixing screws are tight. They may vibrate loose over time.

GMC Customer Assist

If your product needs repairing, replacing, technical service or you simply need help or advice, please contact us on our Customer Assist Line

**1300 880 001 (Australia) or
0800 445 721 (New Zealand).**

*For prompt service we suggest you log your service request online at **www.gmcservice.com.au**.*

Should you not have access to the Internet, please contact our service department on

**1300 880 001 (Australia) or
0800 445 721 (New Zealand).
7am – 7pm, 7 days a week (AEST).**

Please note that if repair or replacement is required, you must provide a valid original purchase receipt.

You will need the following details at hand to log your service request;

Personal details: First & Last name, address, pick up address, contact phone numbers, email address

Product details: Product number, date of purchase, retailer bought from, State & postcode, receipt number, reason for the request, copy of official purchase receipt

*Please refer to our website **www.gmcompany.com** for full GMC warranty Terms and Conditions.*



45–55 South Centre Road
Melbourne Airport
Victoria, Australia 3045
Tel: (03) 8346 1100 Fax: (03) 8346 1200

Attach your purchase receipt and save with this Manual for future reference.