



USER'S MANUAL

Duct Type Series

Built-in duct : AVMBH**

ENGLISH

ESPAÑOL

FRANÇAIS

ITALIANO

PORTUGUÊS

DEUTSCH

ΕΛΛΗΝΙΚΑ

RUSSIAN

System Air Conditioner

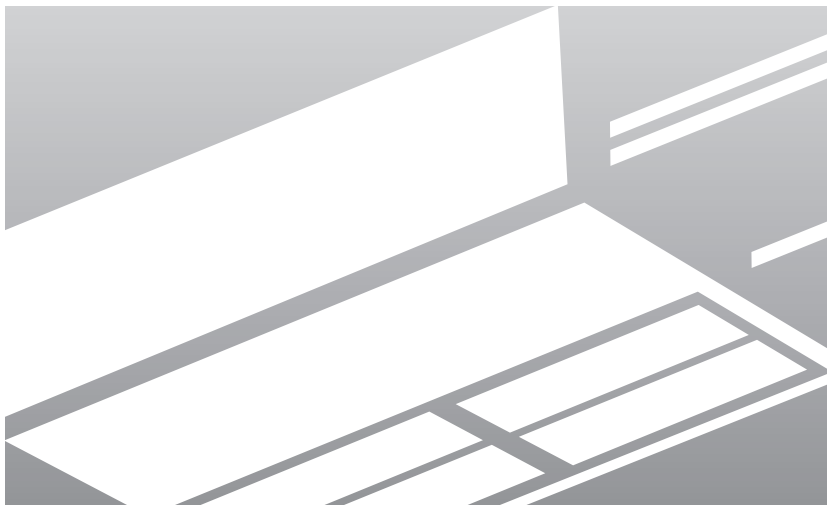

Safety Precautions

The following safety precautions must be taken when using your air conditioner.



WARNING

- Risk of electric shock can cause injury or death.
- Disconnect all remote electric power supplies before servicing, installing or cleaning.
- This must be done by the manufacturer or its service agent or a similar qualified person in order to avoid a hazard.

DURING OPERATION

- ◆ Users of this product are cautioned not to attempt repair of this product at their own discretion. Instead, they are requested to directly contact a designated service center or the outlet at which the product was purchased.
- ◆ Never spill any kind of liquid into the unit. Should this happen, unplug or main switch off the unit and contact an authorized service center.
- ◆ Do not insert anything between the air outlet blades because the inner fan may be damaged and could cause injury. Keep children away from the unit.
- ◆ Do not place any obstacles in front of the unit.
- ◆ Do not spray liquid of any kind into the indoor unit. Should this happen, switch off the breaker used for your air conditioner and contact your installation specialist.
- ◆ Make sure that the unit is correctly ventilated at all times:
Do not place clothing or other materials over it.
- ◆ If the wireless remote control will not be used for a long time, remove the batteries. (If applicable)
- ◆ When using a wireless remote control, the distance should not be more than 7 meters from the air conditioner. (If applicable)

DISPOSING OF THE UNIT

- ◆ Before throwing out the device, it is necessary to pull back the battery cells and get rid of them safely for recycling reasons.
- ◆ When you need to dispose of the unit, consult your dealer. If pipes are removed incorrectly, refrigerant may blow out and come into contact with your skin, causing injury. Releasing refrigerant into the atmosphere also damages the environments.
- ◆ Please recycle or dispose of the packaging material for this product in an environmentally responsible manner.

OTHERS

- ◆ Never store or ship the air conditioner upside down or sideways to avoid damage to the compressor.
- ◆ The appliance is not intended for use by young children or infirm persons without supervision: Young children should be supervised to ensure that they do not play with the appliance.
- ◆ Max current is measured according to IEC standard for safety and current is measured according to ISO standard for energy efficiency.

Contents

◆ PREPARING YOUR AIR CONDITIONER	
■ Safety Precautions	2
■ View of the Unit	4
■ Wireless Remote Controller-Buttons and Display	6
■ The Receiver & Display Unit	7
■ Wired Remote Controller-Buttons and Display	8
■ Centralized Controller	9
■ Function Controller	10
◆ RECOMMENDATIONS FOR USE	
■ Operating Recommendations	11
■ Temperature and Humidity Ranges	12
■ Cleaning Your Air Conditioner	13
■ Solving Common Problems	14



Correct Disposal of This Product (Waste Electrical & Electronic Equipment)

(Applicable in the European Union and other European countries with separate collection systems)

This marking shown on the product or its literature, indicates that it should not be disposed with other household wastes at the end of its working life. To prevent possible harm to the environment or human health from uncontrolled waste disposal, please separate this from other types of wastes and recycle it responsibly to promote the sustainable reuse of material resources.

Household users should contact either the retailer where they purchased this product, or their local government office, for details of where and how they can take this item for environmentally safe recycling.

Business users should contact their supplier and check the terms and conditions of the purchase contract. This product should not be mixed with other commercial wastes for disposal.

View of the Unit

The figures are shown in this instruction may differ from yours depending on the model.

Indoor Unit **020/026/032/035/040**

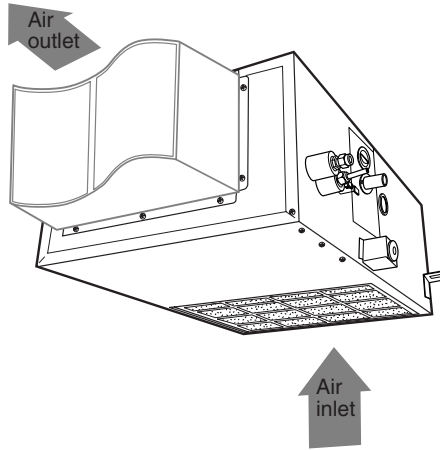

Indoor Unit **052/070/072**

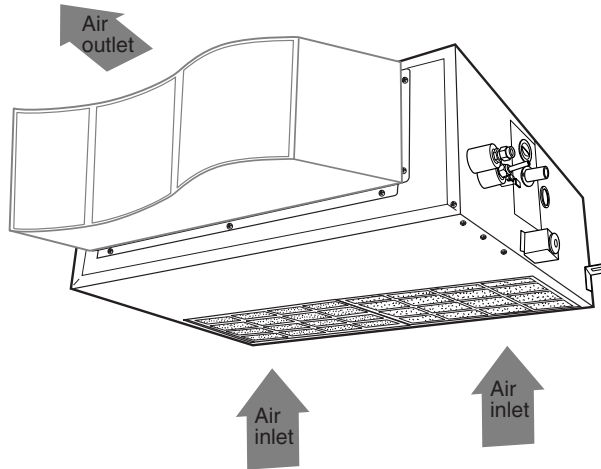

Outdoor Unit

TYPE A

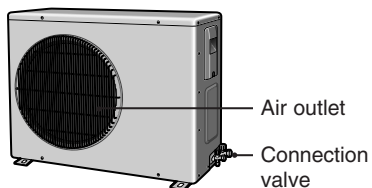

TYPE B

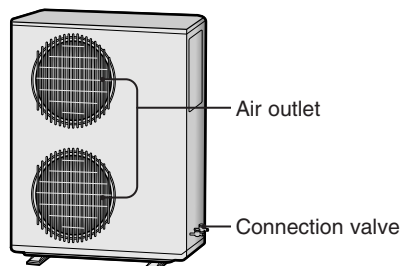

Outdoor Unit

TYPE C

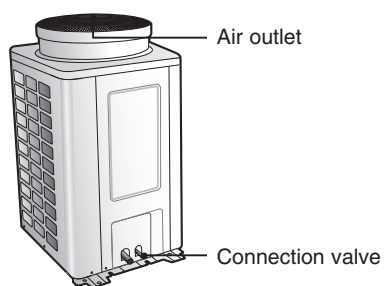

TYPE D

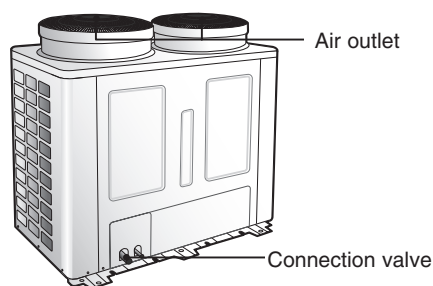

Outdoor Unit

TYPE E

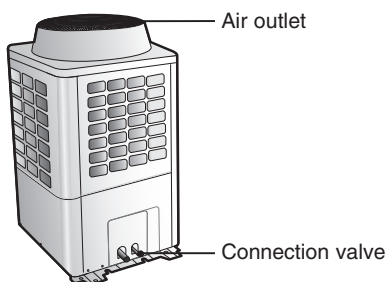

TYPE F

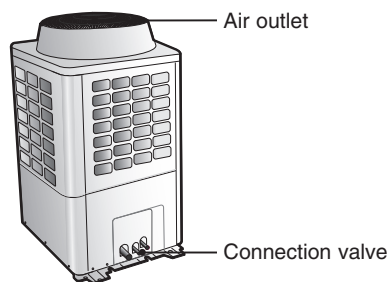

Note If the heat exchanger in the outdoor unit gets dusty, cooling efficiency may fall. So clean the heat exchanger with water when it becomes dirty. However, be careful when you wash the surface of the heat exchanger because it is very sharp.

Wireless Remote Controller-Buttons and Display

The wireless remote controller is an optional accessory.
To use the wireless remote controller, refer to an appropriate manual.

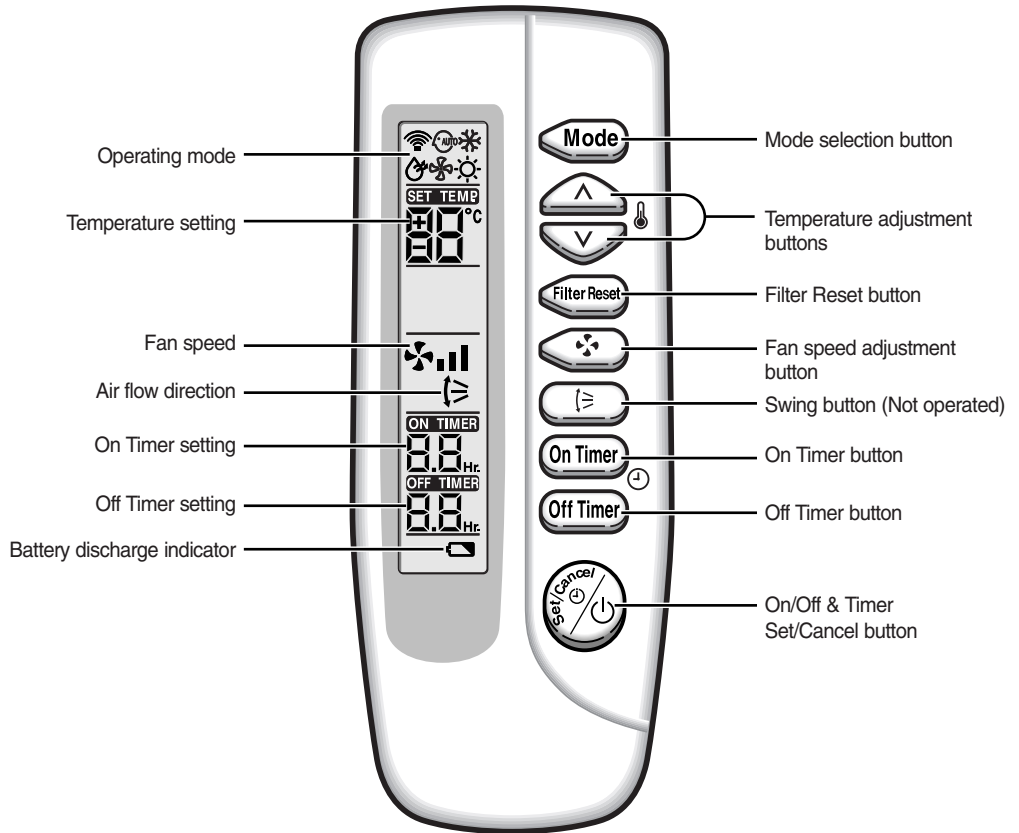

- Note**
- ◆ After cleaning the air filter, press the filter reset button.
 - ◆ Duct type air conditioner does not have function of adjusting air flow direction. Therefore, the function is not operated even if you press the swing button.
 - ◆ To control indoor unit with wireless remote controller, you should install a receiver and display unit.

The Receiver & Display Unit

The Receiver & Display unit is an optional accessory and it is installed on the wall.
To use the receiver & display unit, refer to an appropriate manual.

Concealed Type

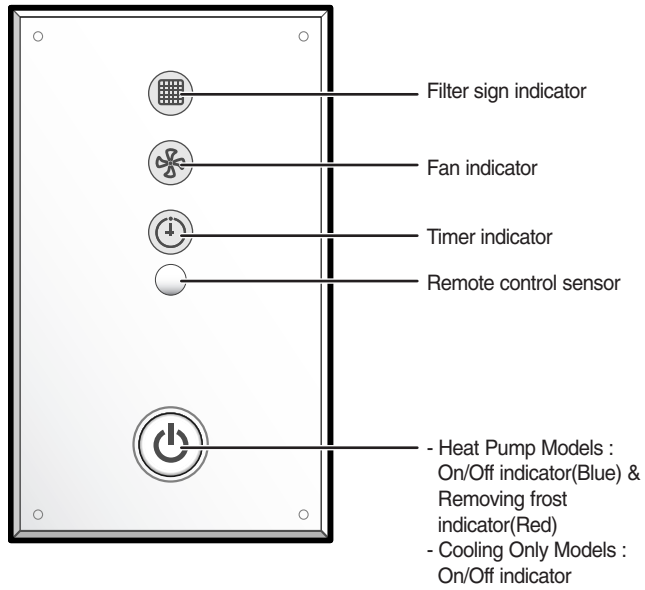

Wired Remote Controller-Buttons and Display

The wired remote controller is an optional accessory and it is installed on the wall.
To use the wired remote controller, refer to an appropriate manual.

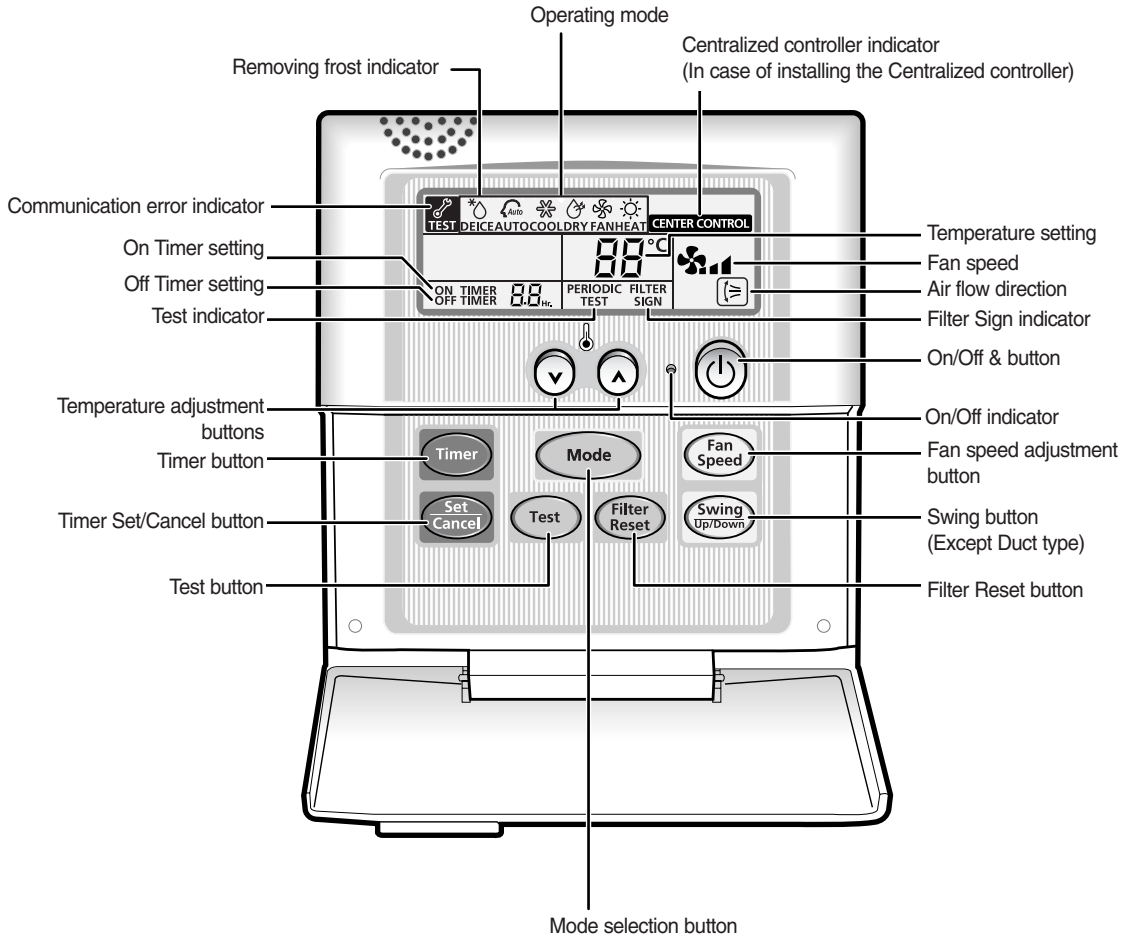

- Note**
- ◆ The **Test** button is for your installation specialist. You must NOT press it.
 - ◆ After cleaning the air filter, press the **Filter Reset** button. Then the wired remote controller will display the FILTER SIGN indicator when the time to clean the air filter.
 - ◆ Duct type air conditioner does not have function of adjusting air flow direction. Therefore, the function is not operated even if you press the **Swing Up/Down** button.

Centralized Controller

The centralized controller is an optional accessory and it is installed on the wall. To use the centralized controller, refer to an appropriate manual.

Front View

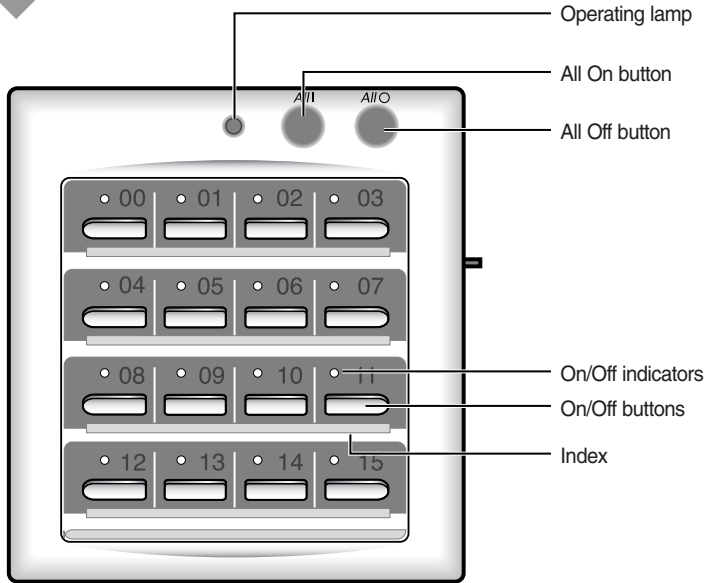

Note The operating lamp comes on even when only one air conditioner connected to the centralized controller is operating.

Side View

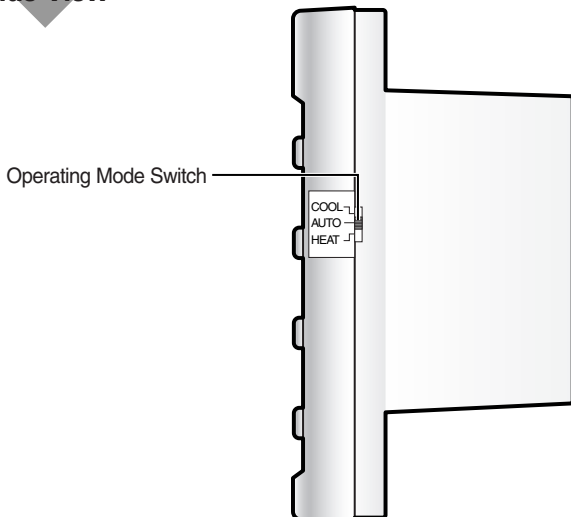

Note

- ◆ Choose the appropriate operating mode with the Operating Mode Switch that enables the user to choose between the Cool/Auto/Heat mode.
- ◆ The heating mode (☀) is not selected in cooling only models.

Function Controller

The function controller is an optional accessory and it is installed on the wall.
 The function controller is an additional controller which is used with the centralized controller.
 To use the function controller, refer to an appropriate manual.

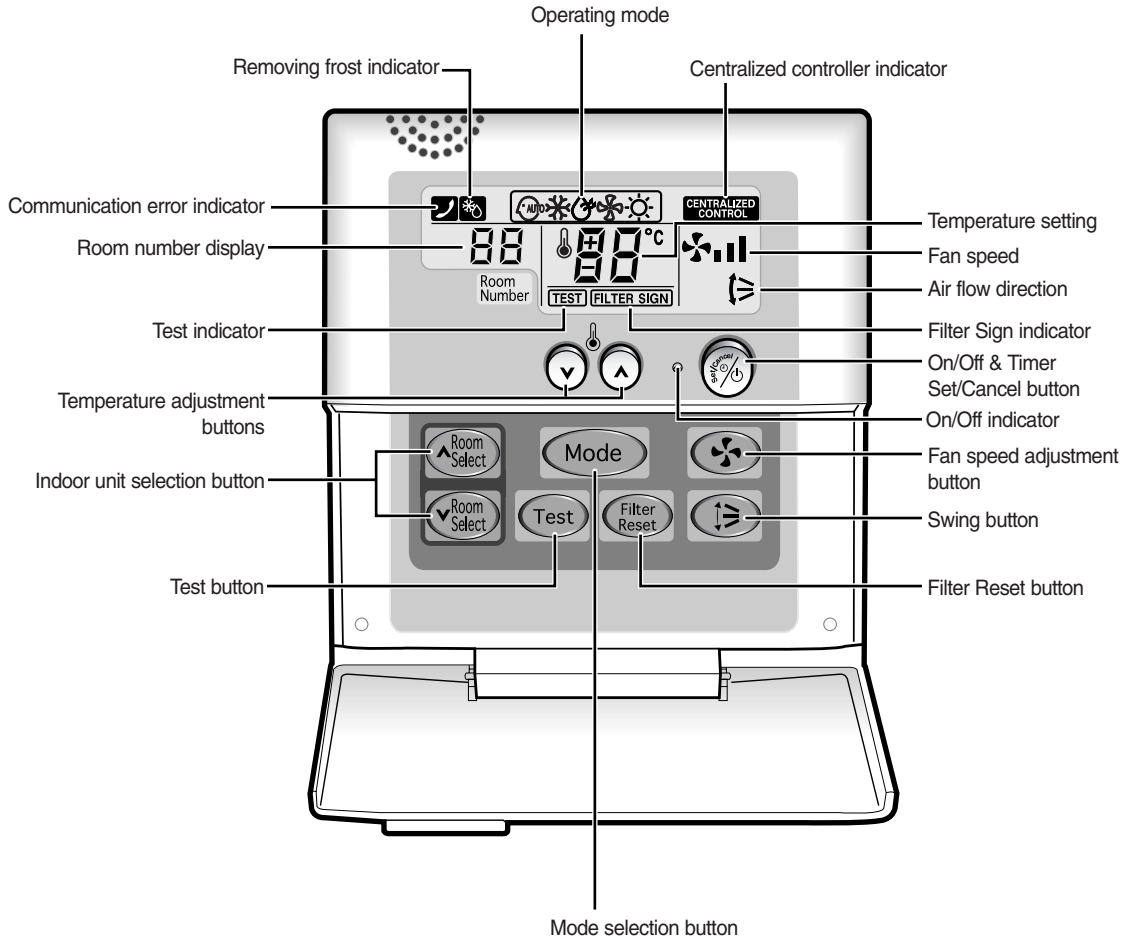

- Note**
- ◆ Test button is for your installation specialist. You must NOT press it.
 - ◆ After cleaning the air filter, press the filter reset button. Then the wired remote controller will display the FILTER SIGN indicator when the time to clean the air filter.
 - ◆ Duct type air conditioner does not have function of adjusting air flow direction. Therefore, the function is not operated even if you press the swing button.

Operating Recommendations

Here are a few recommendations that you should follow when operating your air conditioner.

Topic	Recommendation
Heating performances	The heat pump function of the air conditioner absorbs heat from outside air and brings it indoors. As the temperature of the outside air drops, the heating performance of air conditioner will decrease. If you find that the room is not warm enough, using an additional heating appliance is recommended.
Frost	When outside temperature is low but humidity is high, frost may form on the outdoor unit at HEAT mode. If this happens: <ul style="list-style-type: none"> ◆ The heating operation stops. ◆ The defrost mode will be triggered automatically for about 10 minutes. No intervention is required ; after about 10 minutes, the air conditioner operates again normally.
High indoor and outdoor temperatures	If both indoor and outdoor temperatures are high and the air conditioner is running at HEAT mode, the outdoor unit's fan and compressor may stop at times. This is normal ; simply wait until the air conditioner switches on again.
Power failure	If a power failure occurs while the air conditioner is operating, the unit will be switched off. When the power returns, the air conditioner starts up again automatically.

Temperature and Humidity Ranges

The following table indicates the temperature and humidity ranges, within which the air conditioner can be used.

If the air conditioner is used at...	Then...
High temperature	The automatic protection feature may be triggered and the air conditioner stopped.
Low temperature	A water leakage or some other malfunction may happen if the heat exchanger freezes.
High humidity levels	Water may condense on and drip from the surface of the indoor unit if it is used for a long periods.

Mode	Outdoor Temperature	Indoor Temperature	Indoor Humidity
Heating	-15°C to 24°C approx.	27°C or less	-
Cooling	- 5°C to 43°C approx.	18°C to 32°C approx.	80% or less
Drying	- 5°C to 43°C approx.	18°C to 32°C approx.	-

- ※ **The standardized temperature for heating is 7°C. If the outdoor temperature drops to 0°C or below, the heating capacity can be reduced depending on the temperature condition. If the cooling operation is used at over 32°C(indoor temperature), it does not cool at its full capacity.**

Cleaning Your Air Conditioner

To get the best possible use out of your air conditioner, you must clean it regularly to remove the dust that accumulates on the air filter.

CAUTION Before cleaning your air conditioner, ensure that you have switched off the electric circuit breaker used for the unit.

- 1 Separate filter supporting screw.
- 2 Remove the front grille.
- 3 Remove all dust on air filter with a vacuum cleaner or a brush. In case of serious dust accumulation, put the air filter in warm detergent water and shake it vertically.
- 4 After washing, allow them to dry thoroughly in an area protected from sunlight.
- 5 When you have finished, insert the filter into the original position.

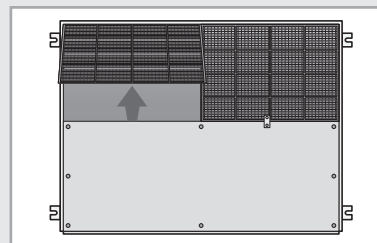
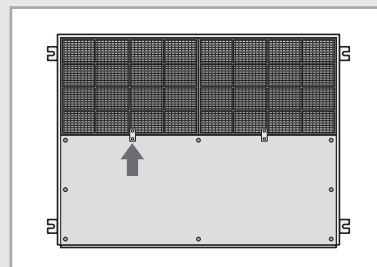

Note

- ◆ After cleaning the air conditioner, press the Filter Reset button.
- ◆ Do not operate the air conditioner without the filter.
- ◆ To control indoor unit with wireless remote controller, you should install a receiver and display unit.

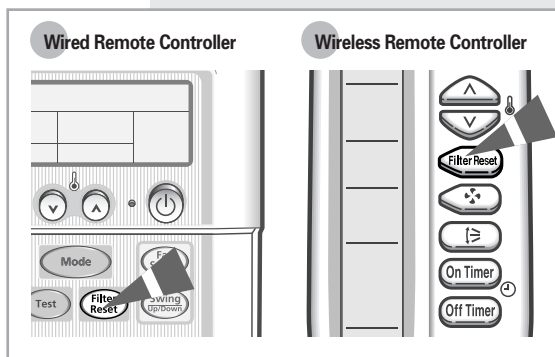

Solving Common Problems

Before contacting the after-sales service, perform the following simple checks. They may save your time and expense of an unnecessary call.

Problem	Explanation/Solution
The air conditioner does not operate at all	◆ Check that the breaker used for the air conditioner is switched on.

Wired Remote Controller

The air conditioner does not operate with the remote controller	◆  is displayed on the wired remote controller. In this case, turn the air conditioner off and contact your dealer.
---	--

Wired Remote Controller

When turning on/off the air conditioner, it is not turned on/off immediately.	◆ In case of using the wired remote controller for a group, the air conditioners connected to the remote controller are turned on/off in order. Thus, it takes some time (up to 32 seconds).
---	--

Wireless Remote Controller

The air conditioner does not operate with the remote controller	◆ Check that there are no obstacles between you and the remote control sensor.
	◆ Check the wireless remote controller batteries.
	◆ Check that you are close enough to the remote control sensor (7 metres/yards or less).

Wireless Remote Controller

No beep is heard when you press  (ON/OFF) on the remote controller	◆ Check that you are pointing the remote controller at the remote control sensor on the receiver & display unit.
	◆ Replace the remote controller batteries if necessary.
	◆ If there is a strong light around the air conditioner, a three-wavelength light, a neon sign, etc., for example, the air conditioner may not be operated with a remote controller. If this happens, use the remote controller close by the remote control sensor.

The air conditioner does not cool or heat	◆ Check that the correct operating mode has been selected.
	◆ The room temperature may be too low or too high.
	◆ Dust may be blocking the air filter guard; refer to page 13 for cleaning instructions.
	◆ Check that there is no obstacle in front of the outdoor unit.

When heating, the required room temperature is never reached and the air conditioner frequently stops	◆ Check that the required temperature has been set correctly.
	◆ Increase the fan speed.



Contact SAMSUNG WORLD WIDE

If you have any comments or questions regarding a Samsung products, contact the SAMSUNG customer care center.

Country	Customer Care Center 	Web Site
BELGIUM	02 201 2418	www.samsung.com/be
CZECH REPUBLIC	844 000 844	www.samsung.com/cz
DENMARK	38 322 887	www.samsung.com/dk
FINLAND	09 693 79 554	www.samsung.com/fi
FRANCE	08 25 08 65 65 (€ 0,15/min)	www.samsung.com/fr
GERMANY	01805 - 121213 (€ 0,12/min)	www.samsung.de
HUNGARY	06 40 985 985	www.samsung.com/hu
ITALIA	199 153 153	www.samsung.com/it
LUXEMBURG	02 261 03 710	www.samsung.lu
NETHERLANDS	0900 20 200 88 (€ 0.10/min)	www.samsung.com/nl
NORWAY	231 627 22	www.samsung.com/no
POLAND	0 801 801 881	www.samsung.com/pl
PORTUGAL	80 8 200 128	www.samsung.com/pt
SLOVAKIA	0850 123 989	www.samsung.com/sk
SPAIN	902 10 11 30	www.samsung.com/es
SWEDEN	08 585 367 87	www.samsung.com/se
U.K	0870 242 0303	www.samsung.com/uk
RUSSIA	8-800-200-0400	www.samsung.ru
KAZAHSTAN	8-800-080-1188	www.samsung.kz
UZBEKISTAN	140-1234	www.samsung.uz
UKRAINE	8-800-502-0000	www.samsung.com/ur
LATVIA	800-7267	-