

■ 서비스센터 대표전화번호

전국 어디서나 **1588-3366**

제품 오동작, 고장상태, 견적서를 정확히 알려 주시면
고객 여러분의 궁금증을 언제나 친절하게 상담,
확실한 서비스를 제공합니다.

■ 사업부 상담실

080-030-3366

상담시간 09:30~17:00
월요일부터 금요일까지

■ 서비스센터 홈페이지

www.samsungsvc.co.kr

고객이 직접 원하는 날짜와 시간에 서비스 접수 및
실시간 사내 상담이 가능한 사일 서비스센터를
운영하고 있습니다.



고객 상담실

서울 02-541-3000, 080-030-3366
부산 051-884-3000, 080-030-3366



인터넷 고객센터

<http://www.gosamsung.co.kr>



인터넷 홈페이지

<http://www.sec.co.kr>



Home Appliance

<http://www.zipel.co.kr>



[SR-S57EL

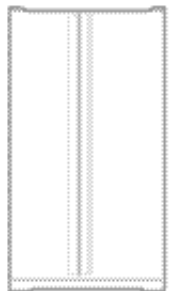

이 제품은 국내(대한민국)용입니다.
전압, 전압이 다른 국외에서는 사용할 수 없습니다.



한국A/B 우수기업 최우수기업
국가기관인 삼성사 내부 기술 표준을 거쳐 소모품에 대한 품질검사와
크게 서비스 우수품 제조업체를 선정하는 우수기업입니다.

AC220V 전용입니다.

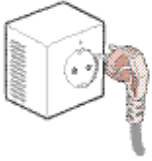

AC110V전원으로 사용하려면

- 송입용 트랜스 (용량 5KVA 이상)를 사용해서 구입하여 냉장고 전원으로 쓰세요.
- 용량이 맞지 않는 송입용 트랜스용 사용할 경우 냉장고 고장의 원인이 됩니다.

新 ?



2 가

新 !

, 가

가

新 !



新 !

가

가 가

新 !

, !

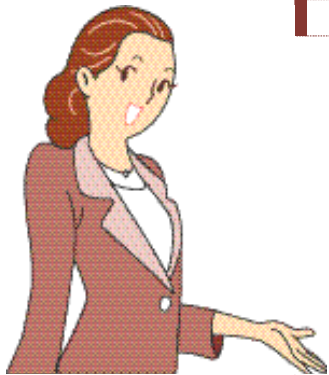

가

3

5

6

7

9

10

11

12

13

15

17

19

22

25

27

28

경고



220V

가

가



가



가 가

220V

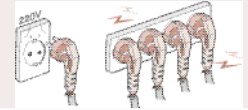

주의

가

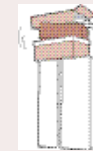

가 가

가

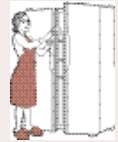

가

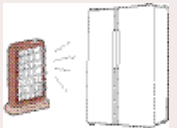
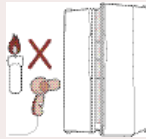

가



가



가

가

가

가



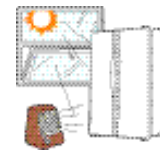
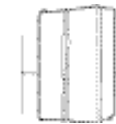
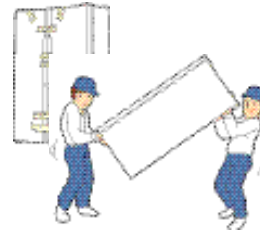
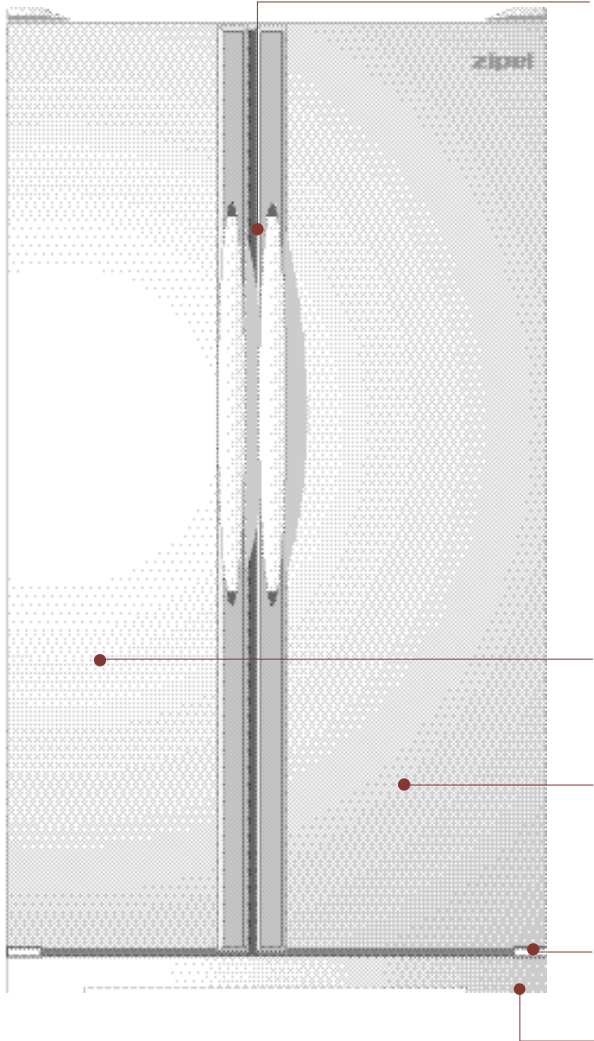

가

5cm, 10cm
가

가 5 가 43
가 가

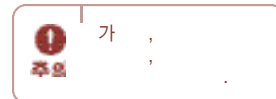

<

가
가

>

<

가
가

>

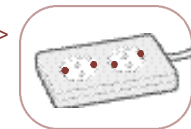

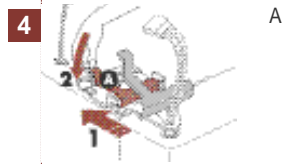
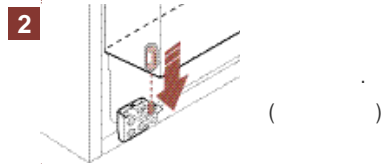
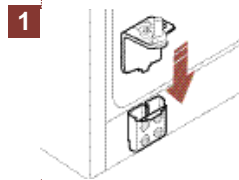
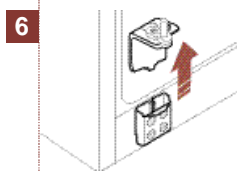
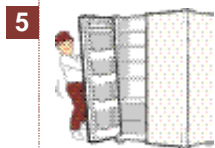
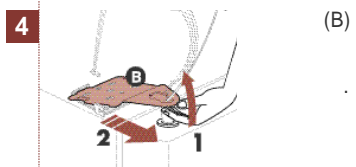
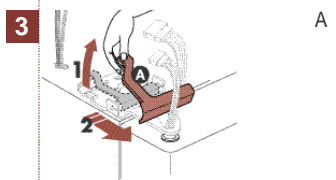
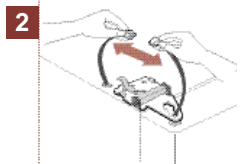
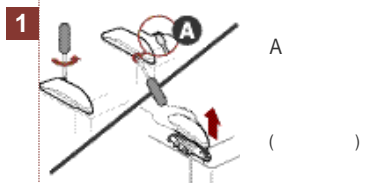



가

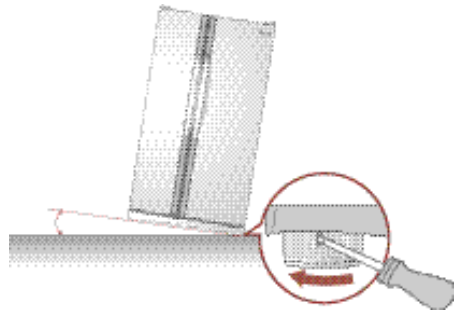
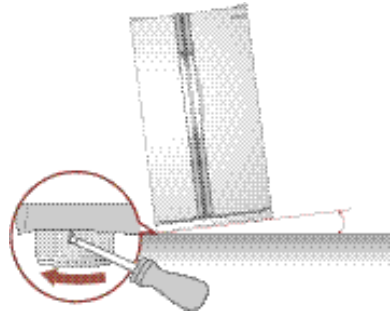

주의 ()
 (: ,)

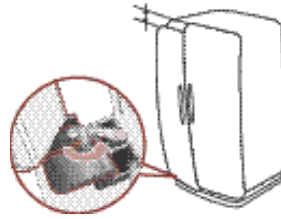

가
() (),

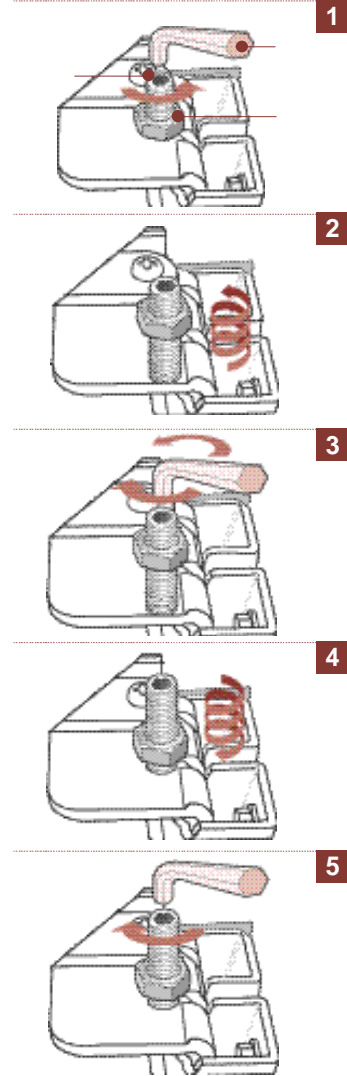

1 ("ㄱ")
 ()

2

3 () ()

4 ()

5

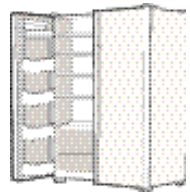

가 가 가 가

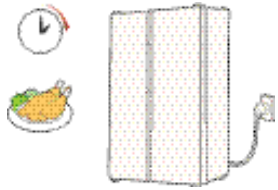

가 2~3 가 가 가



가 가 가 가 가

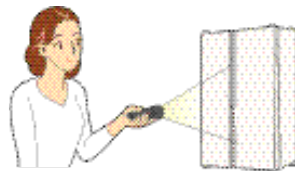

2-3 가



가 가

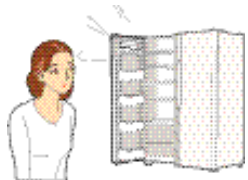

15 , 2 1 10

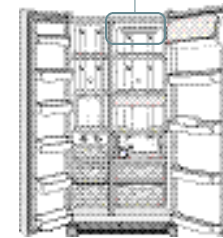

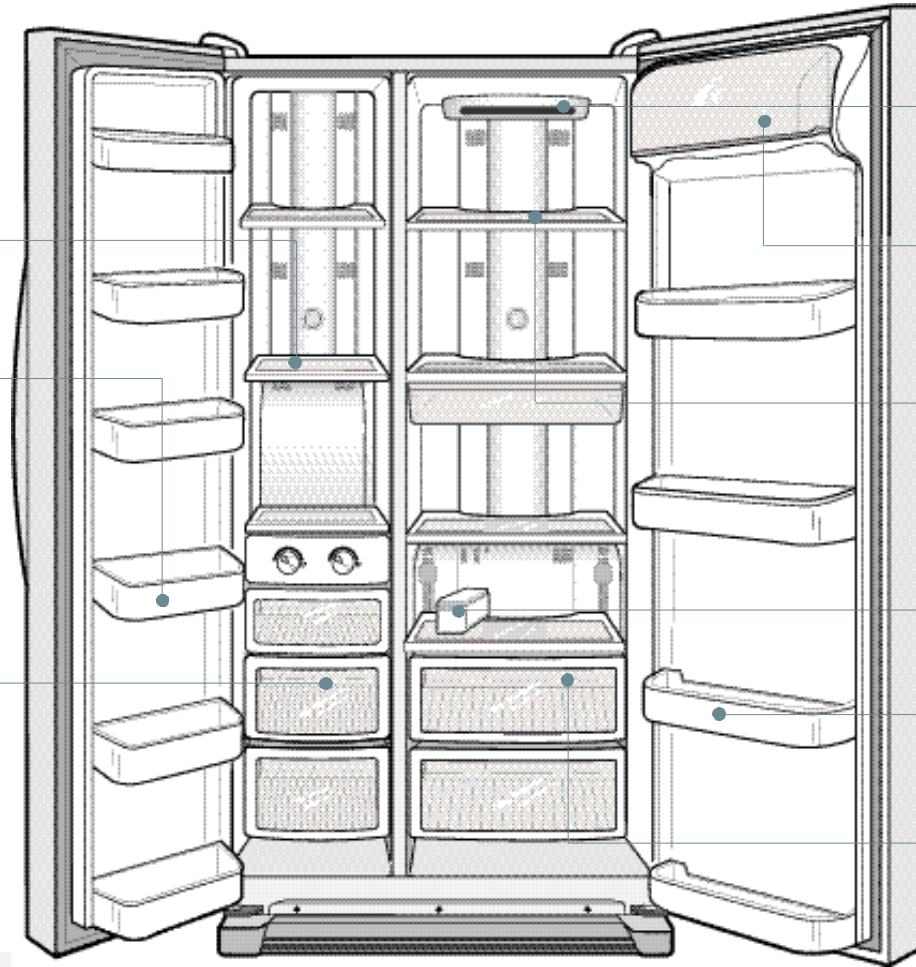

가



가



가



가



가



가



가



가



가



가



가



가



가
가



가



가

가

가

가

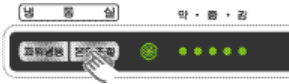

[]
[. . .] 5 가 가 ,

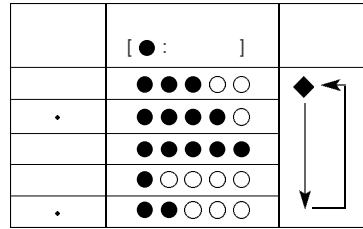

" "



[]
[]



[]
[. . .] 5 가 가 ,

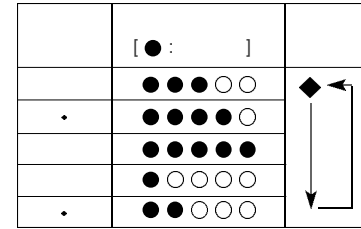

" "

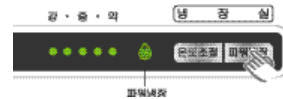

[]
[]





(Red Wine)

(18 ~20)



(White Wine)

. 10



(Rose Wine)

가

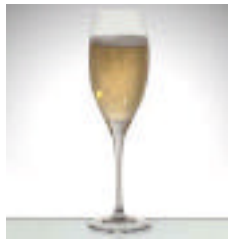

(Sparkling Wine)

가 가 가 가



(Port Wine)

가

가



가

- 1.
2. AOC
- 3.
- 4.
- 5.
- 6.
- 7.
- 8.
- 9.
10. 가

가

가



(Wine Glass)



(Cork Screw)

가



(Vacum Pump)



가

4

0 가 가

가
가

가

가



()

가

가
가

가

가

가

30

가



가



500cc~1L 가

가

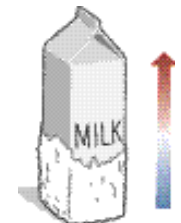

가

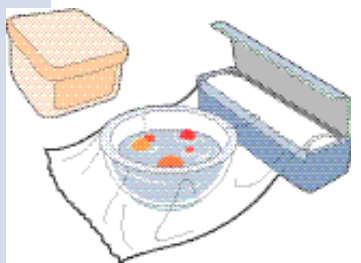



가 가



가 가

가 가

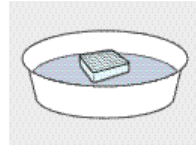
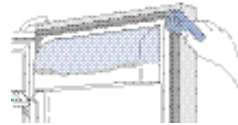
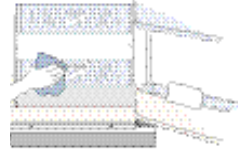

/

1

6 ~1
2L

4

가
8

가

가



가 가 가



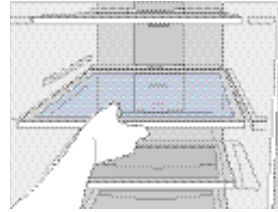
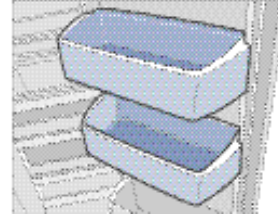
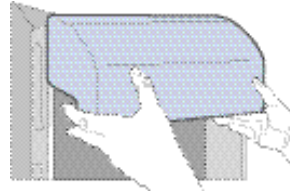
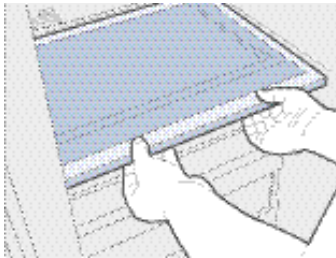
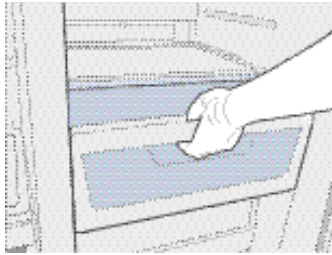
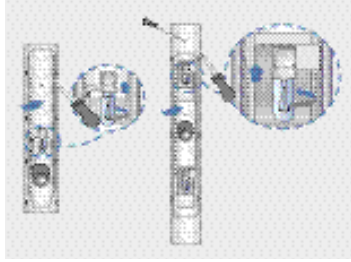
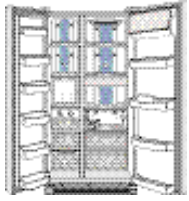



가



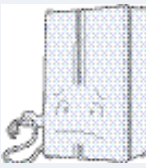

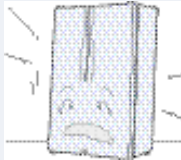
	가 가 ?	.
() 	가 ?	/
	가 가 ?	'
	가 ? 가	, 5cm
	가 가 ?	가
	가 가 ?	가 5
	가 가	.
가 ?		.
	가 ? 가	5cm
	'가 ?	.
	가 ?	.
가	' ' 가 ?	.
	가 ?	가

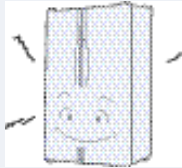
	가 ?	가
! (: , ,) 	가 (: , ,)	
가 ! (: , ,)	가 , 가 가 가	
가 ! (: , ,)	가 , ?	.
	가 ?	(25W)
/ !	가 ? 가	가 5
	가 ? 가	가 가 가

	SR - S57EL
	567
	212
	355
	111kg
(가 x x)	908x1760x727mm
/	AC220V/60Hz

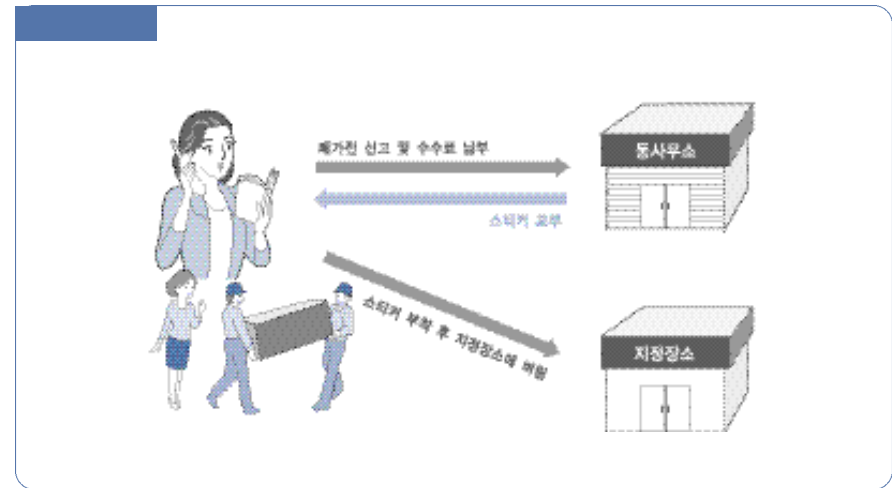
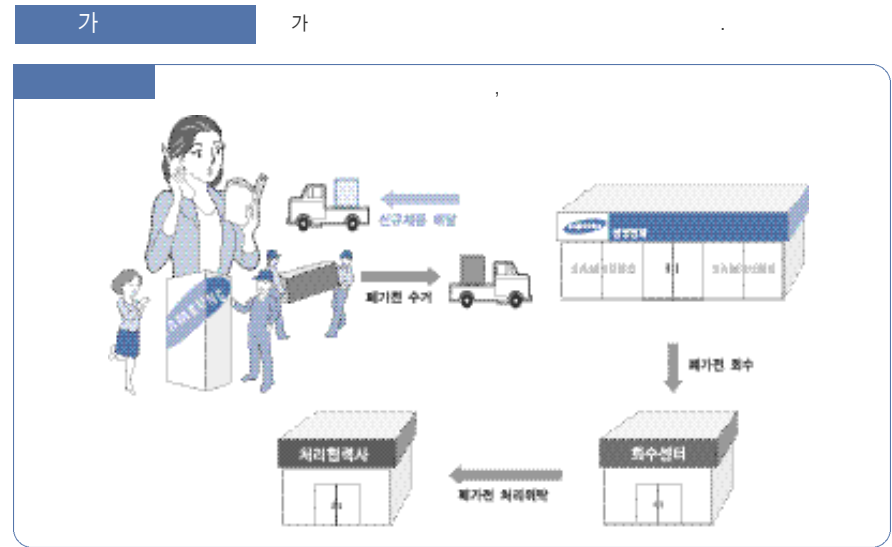
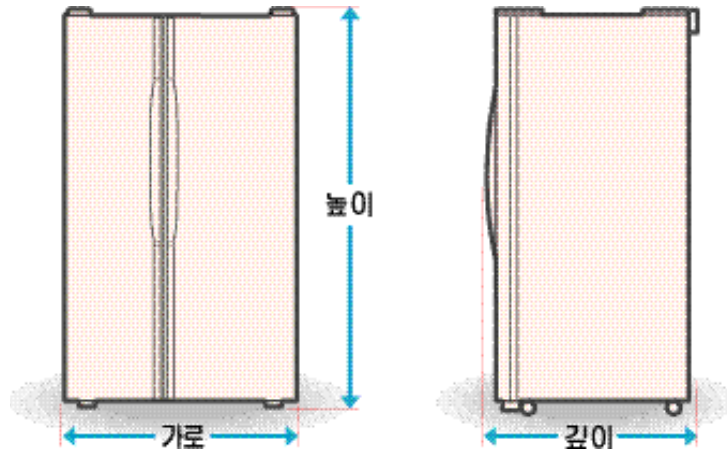

가 가
(: , ,)

가 가

