

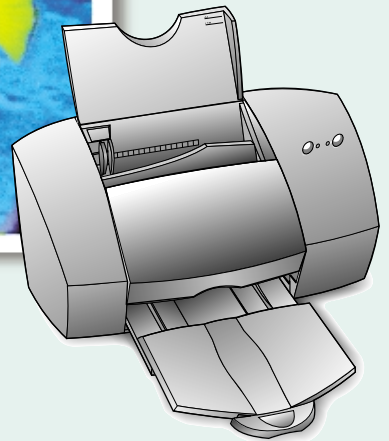

# 삼성 잉크젯 프린터

## 사용설명서

### MJC-1060 Series



(VMS)  
 080-023-8484 ( )  
 OK! 24 24  
 ( )  
 A/S

( ) 1999

(C) Copyright SAMSUNG ELECTRONICS Co., Ltd. 1999

All rights reserved

---

. ( )

가

MJC-1060G Series,

HP, HP PCL3 Hewlett-Packard

Centronics Centronics Data Computer

IBM, IBM PC, XT, AT, PS/2 International Business Machines

TrueType Apple Computer

Microsoft, Windows 3.1, Windows 95/98, MS-DOS Microsoft

한글, HWP

가

# 차례

## 1.

_____	1-1
_____	1-2

## 2.

_____	2-1
_____	2-2
_____	2-4
_____	2-6
95/98 (CD-ROM )	2-6
3.1 (CD-ROM )	2-7
_____	2-8
_____	2-9
_____	2-10

## 3.

_____	3-2
가 _____	3-3
_____	3-3
_____	3-4
_____	3-5
_____	3-6
_____	3-8
_____	3-10
95/98 _____	3-10
3.1 _____	3-11
_____	3-12
95/98 _____	3-12
3.1 _____	3-13
_____	3-14
_____	3-15
_____	3-16

\_\_\_\_\_ - 3-18

한글 \_\_\_\_\_ 3-19

\_\_\_\_\_ 3-20

MY- +, \_\_\_\_\_ V \_\_\_\_\_ 3-22

AutoCAD \_\_\_\_\_ 3-25

### 3.



\_\_\_\_\_ 3-28  
 \_\_\_\_\_ 3-30  
 \_\_\_\_\_ 3-32  
 \_\_\_\_\_ 3-34  
 \_\_\_\_\_ 3-36



\_\_\_\_\_ 3-40  
 95/98 \_\_\_\_\_ 3-40  
 3.1 \_\_\_\_\_ 3-44  
 \_\_\_\_\_ 3-48

USB \_\_\_\_\_ 3-49

### 4.



\_\_\_\_\_ 4-1  
 \_\_\_\_\_ 4-4

### 5.



\_\_\_\_\_ 5-1

### 6.



가 ? \_\_\_\_\_ 6-1  
 가 ? \_\_\_\_\_ 6-2  
 (DOS) 가 ? - 6-6  
 ? \_\_\_\_\_ 6-11  
 가 ? \_\_\_\_\_ 6-13  
 가 ? \_\_\_\_\_ 6-15  
 ? \_\_\_\_\_ 6-16  
 ? \_\_\_\_\_ 6-17  
 ? \_\_\_\_\_ 6-19  
 / \_\_\_\_\_ 6-20

### 7.



\_\_\_\_\_ 7-1  
 ( 가 ) \_\_\_\_\_ 7-4

### 8.

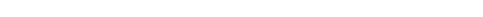

\_\_\_\_\_ 8-1  
 \_\_\_\_\_ 8-1



# 1. 사용하기 전에

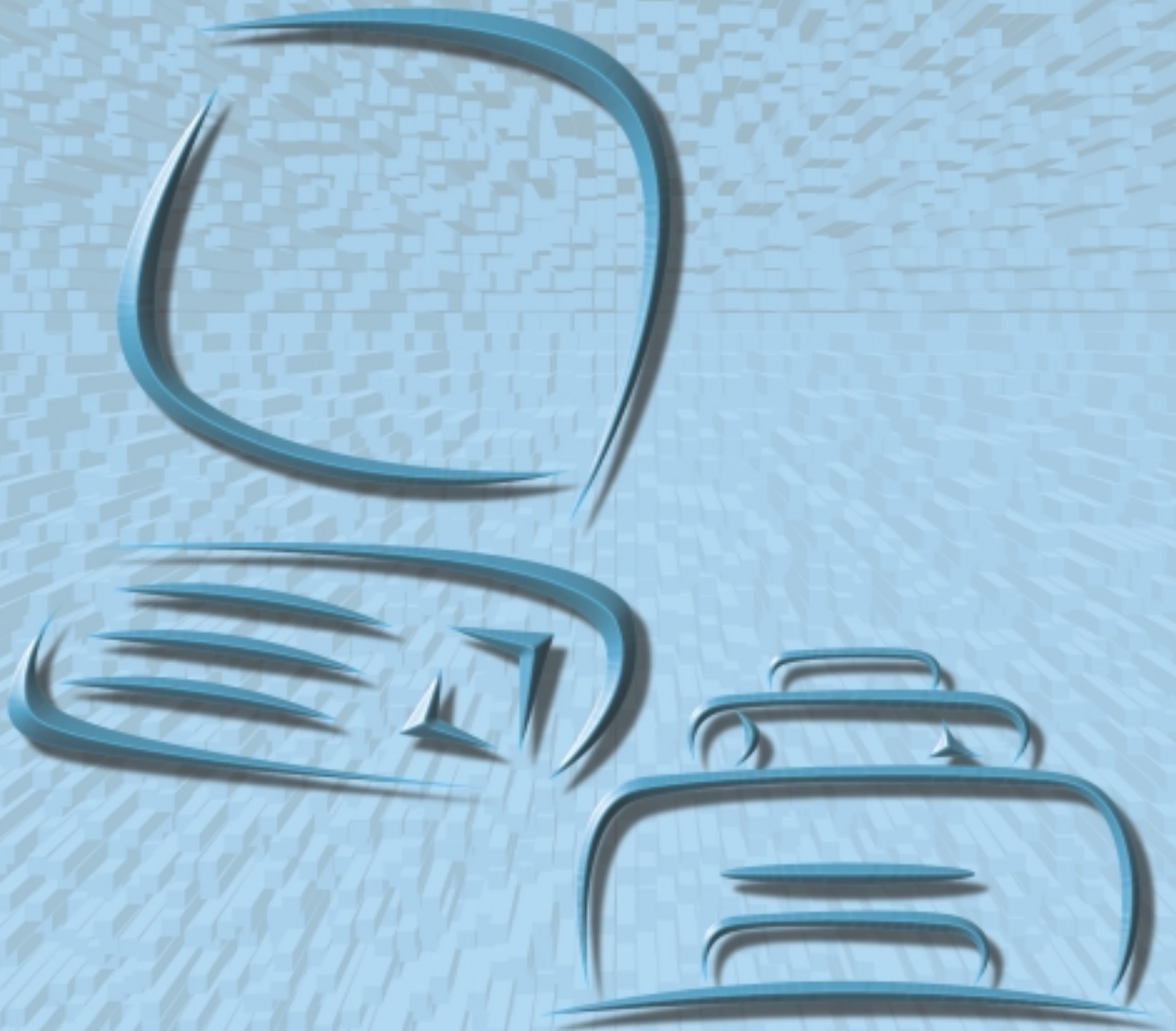



# 사용전 확인

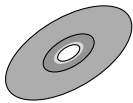
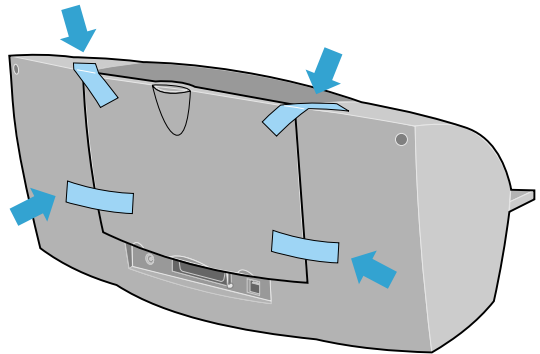
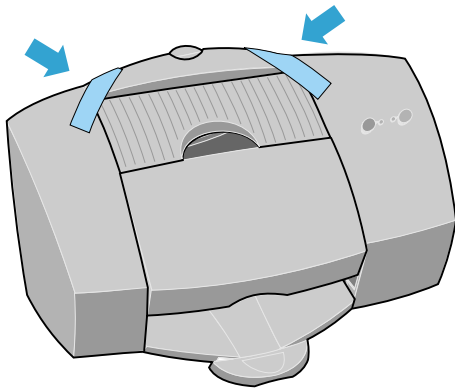

CD-ROM

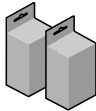
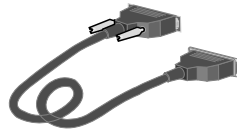
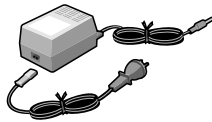

/

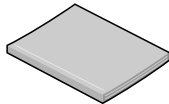

/

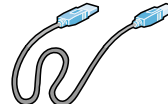

USB



# 각 부분의 이름

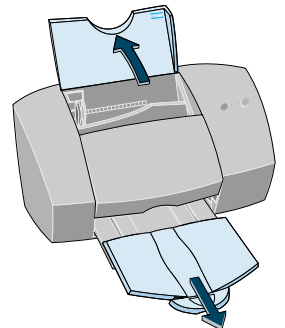
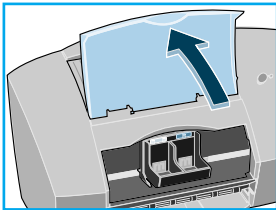
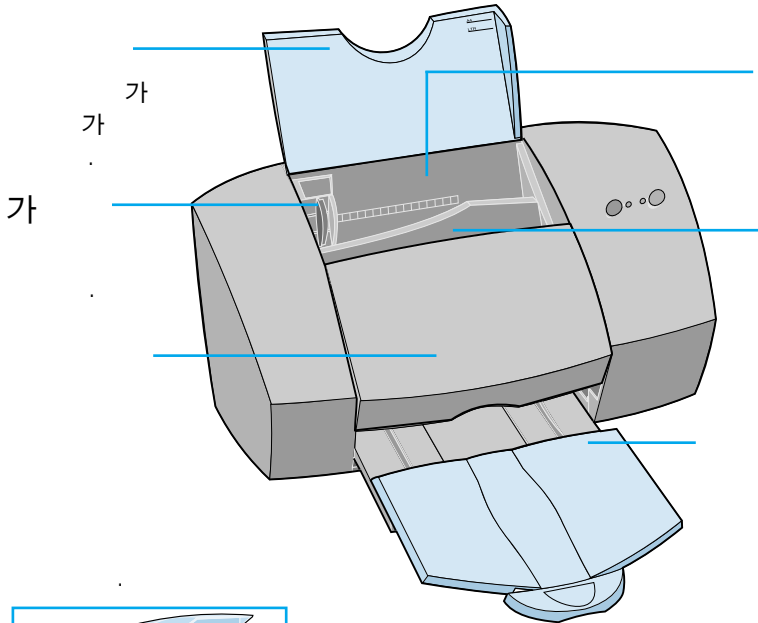

(3-36)

)

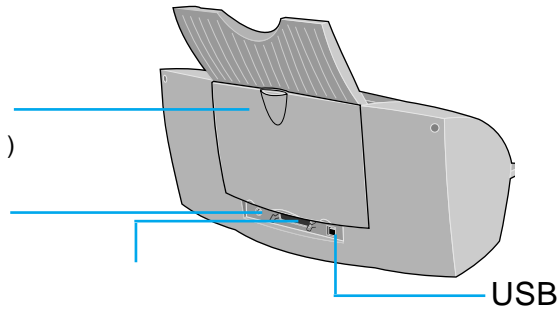

(3-49)

)

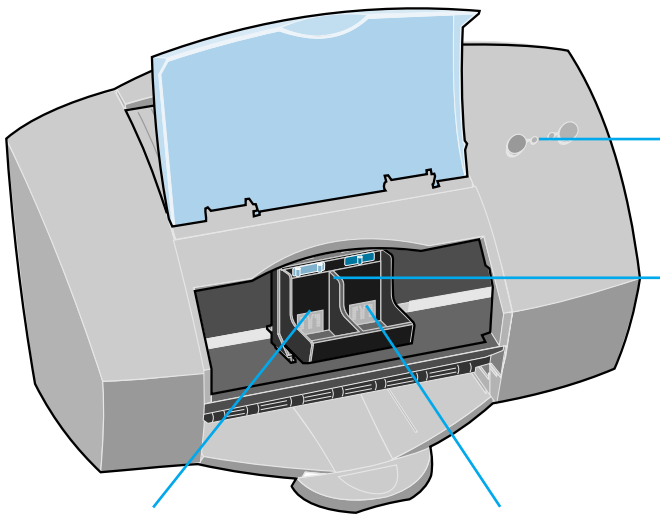

(

)





# 각 부분의 이름

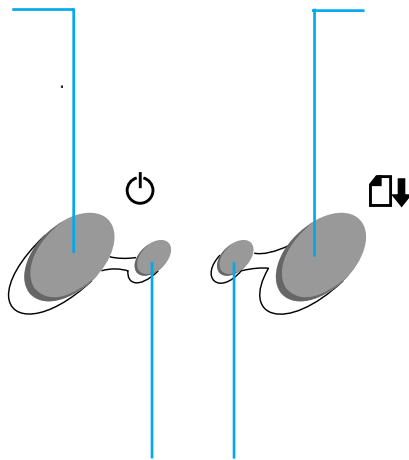

가

가

( 6 )

## 2. 설치방법





# 컴퓨터 및 전원 연결하기

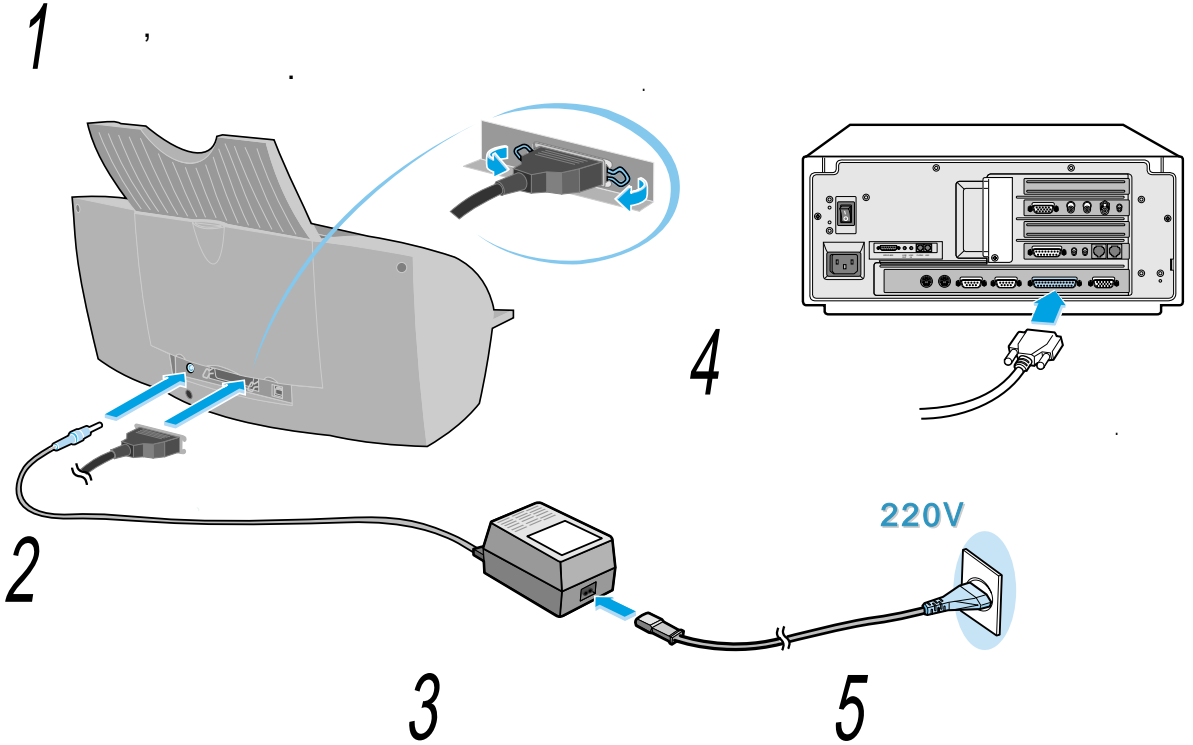

USB

3-49



# 잉크 카트리지 끼우기

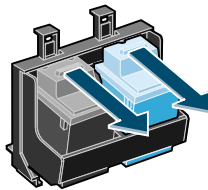
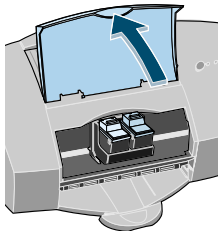
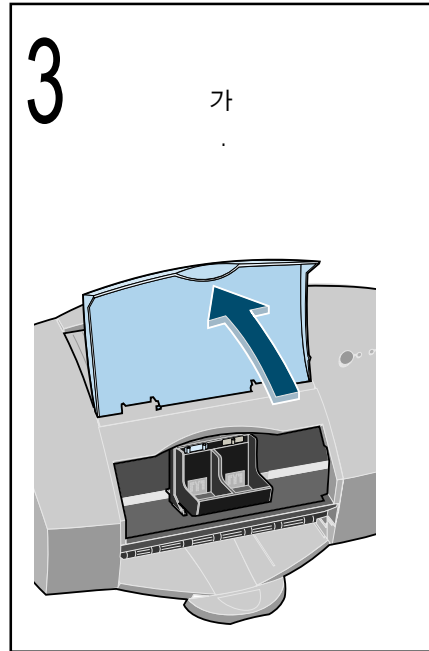
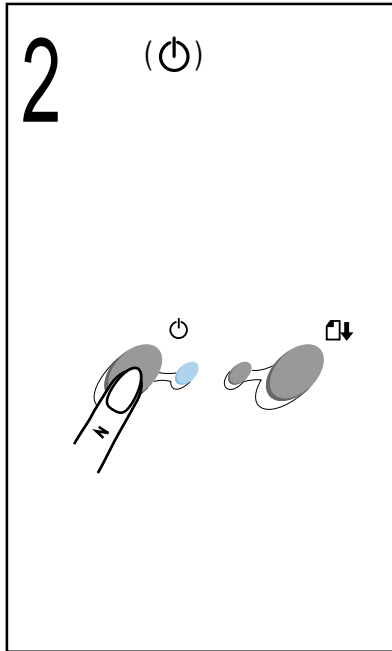
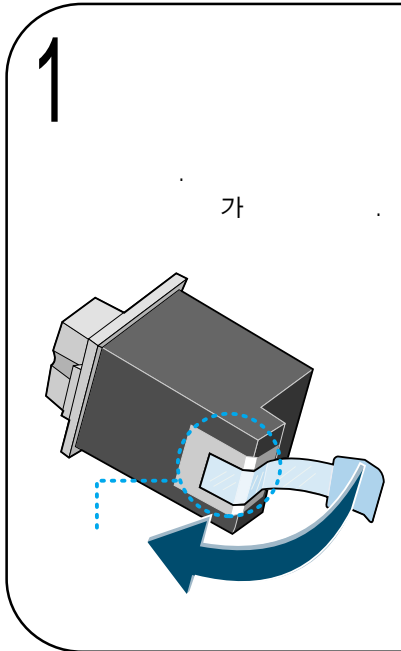

가

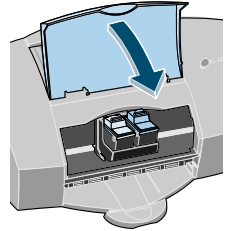
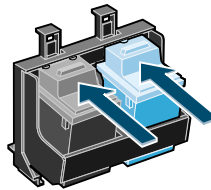

4

가

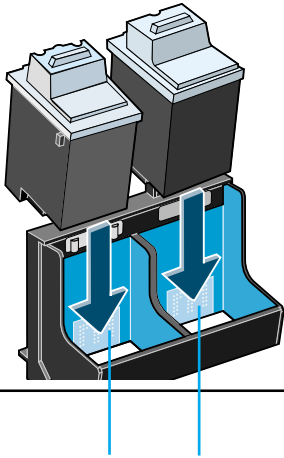

5

가

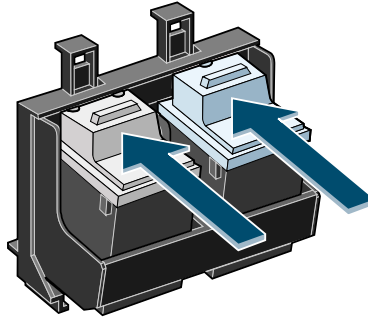

6

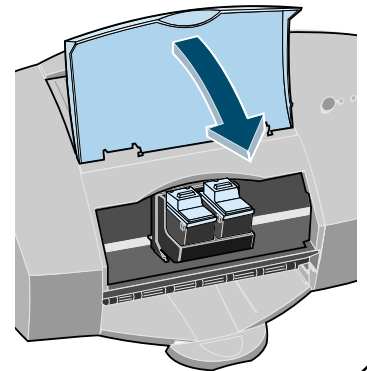



# 용지 넣기와 시험 인쇄 해보기

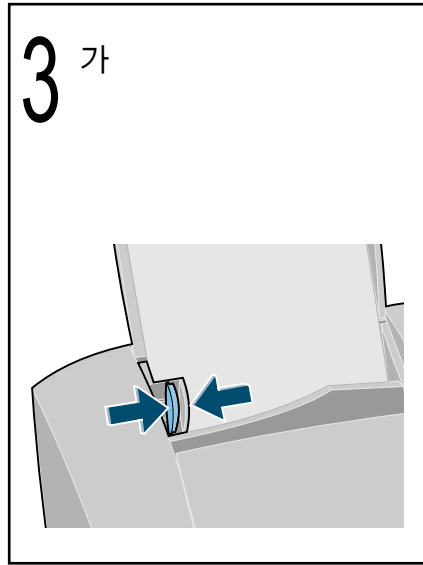
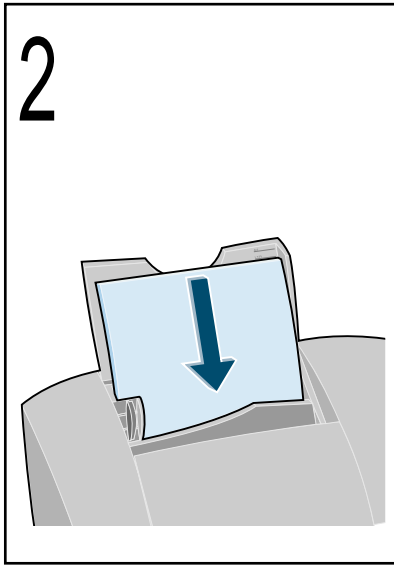
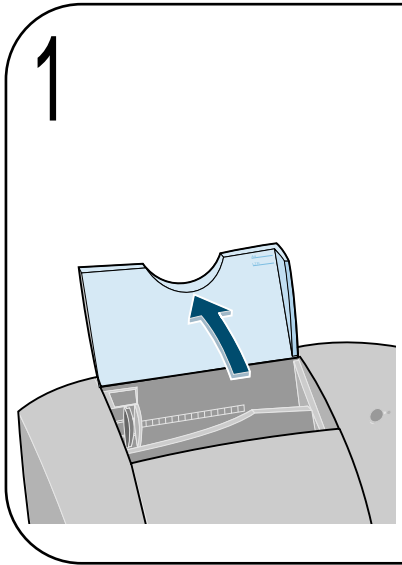

가

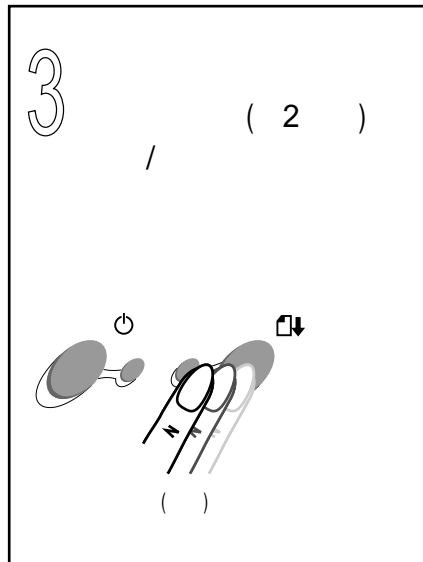
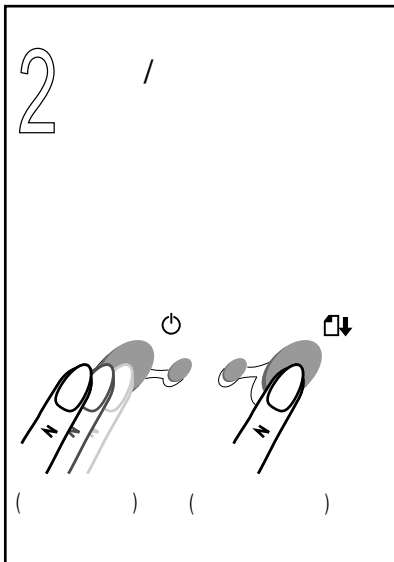
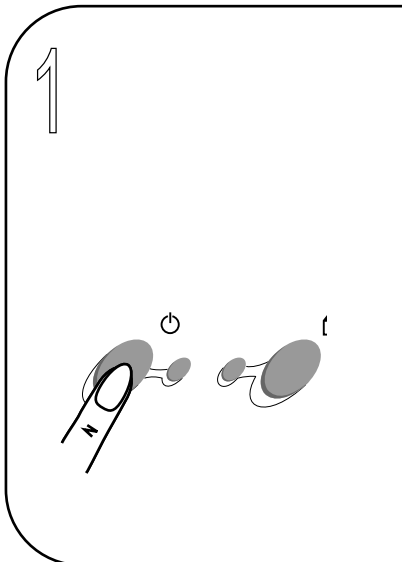

(A4, Letter, Legal, B5, A5, Executive)

가

( :A4-MJ/SIJ)

4

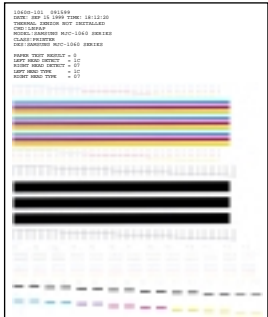

가



A4 Letter

가



# 윈도우용 드라이버 설치하기

95/98 (CD-ROM )

90MHz ( 200MHz )  
16MB (32MB )  
20MB  
CD-ROM  
3.1 95/98



USB

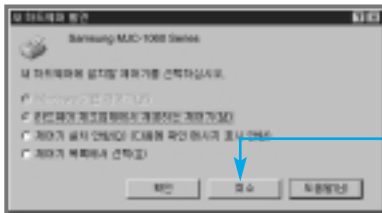

CD-ROM

CD-ROM



1 WIN

CD-ROM

"Wsetup.exe"

(E

e:\Wsetup.exe )





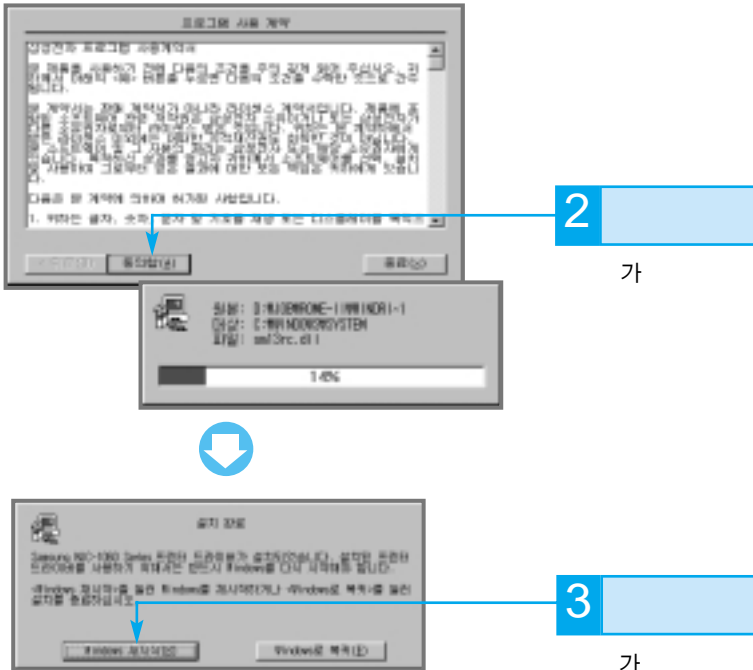

### 3.1 (CD-ROM )

- 1
- 2 CD-ROM CD-ROM
- 3 CD-ROM "Wsetup.exe"  
(E: e:\wsetup.exe )
- 4 2-7 1
- 5 가 가

, CD-ROM 가  
CD-ROM



1

3.1 가

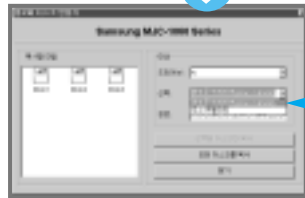

2

CD-ROM "Wsetup.exe"  
(E e:\wsetup.exe )

1 A B

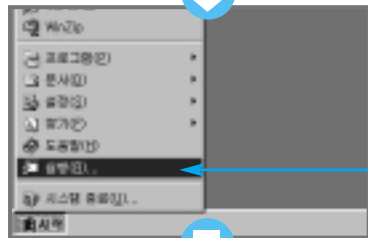

3

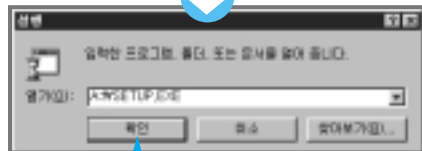

4 A:\WSETUP.EXE  
(B B:\WSETUP.EXE )

5

# 도스유틸리티 설치하기

CD-ROM

CD-ROM



1 DOS

CD-ROM

"\#setup.exe"

(E

e:\#setup.exe

)

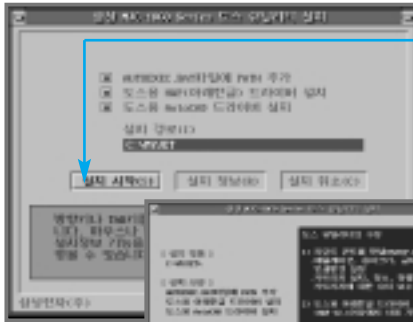

2

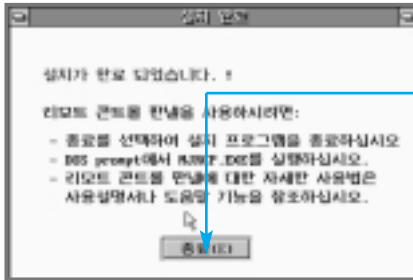

3



KS/KSSM

한글

AutoCAD



# 윈도우 드라이버를 삭제하려면

가

) 95/98

1 MJC-1060 Series

2

3

가

# 3. 사용방법

95/98, DOS

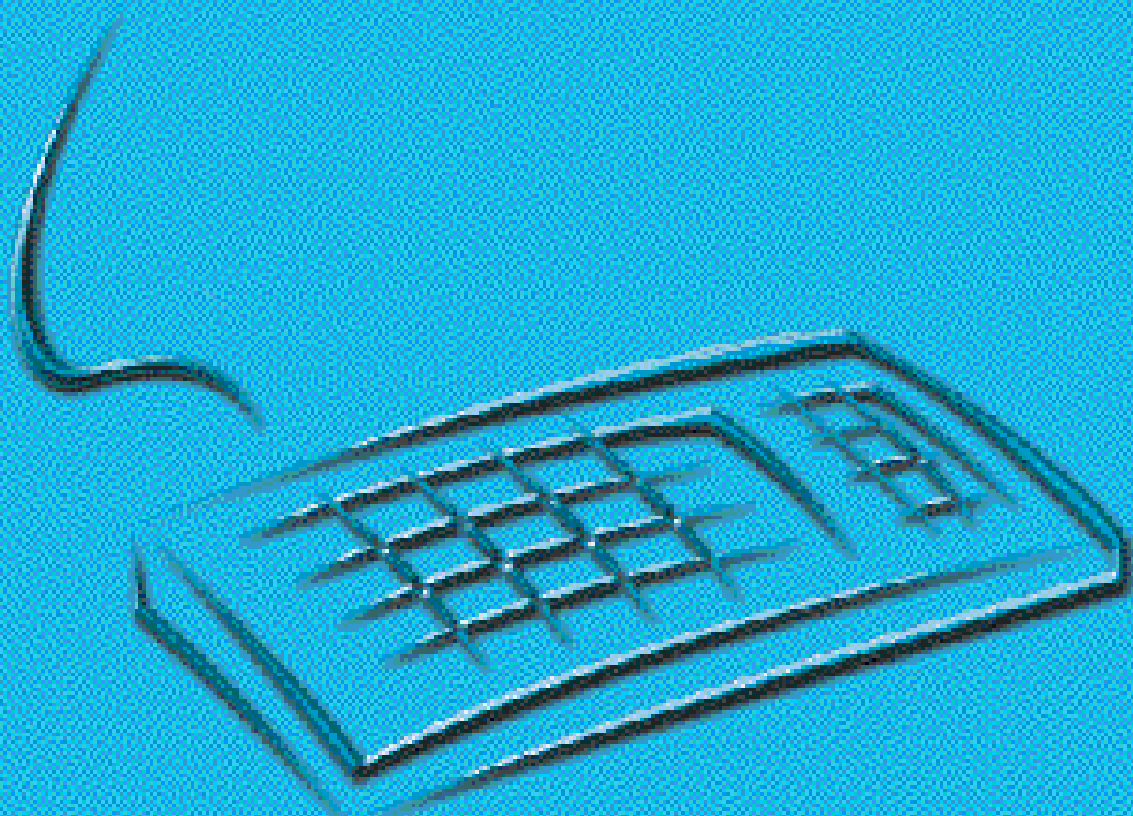

# 윈도우에서 사용방법

가

# WINDOWS

) 95



1

2



3

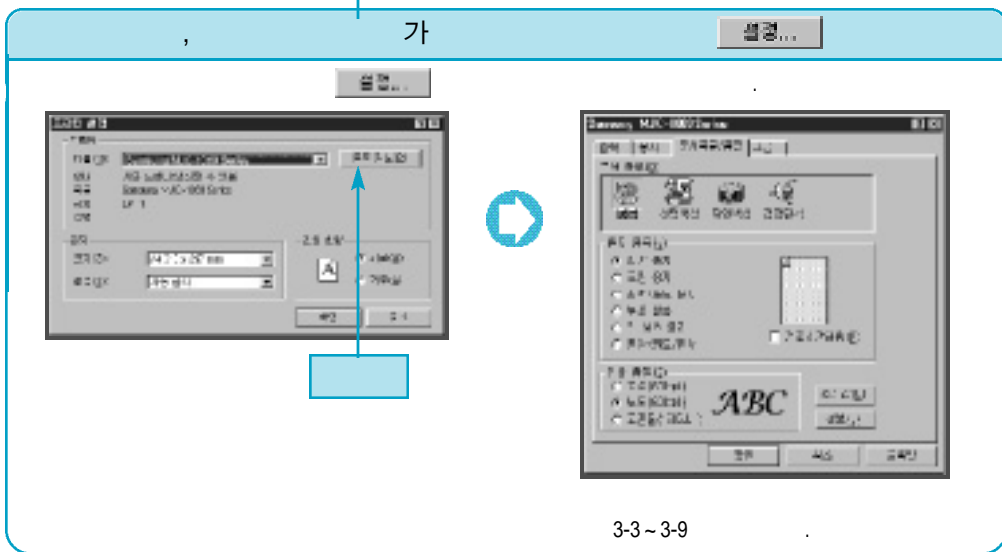

3-3~3-9

# 가



문서종류/종결



가  
가





:1200 x 1200dpi

( )

:600 x 600dpi

:300 x 600dpi



# 여러 가지 인쇄 환경 설정 하기

종이

The screenshot shows the 'Samsung MFC-1080 Service' dialog box. It has tabs for '종이' (Paper), '인쇄속도/품질' (Print Speed/Quality), and '그림' (Image). The '종이' tab is active, showing paper size options: Letter, Statement, A4, Legal, and B5. A dropdown menu is set to 'A4'. Below this, there are radio buttons for '표준 크기' (Standard Size) and '수직 크기 유지' (Maintain Vertical Size). At the bottom, there are checkboxes for '원본 크기' (Original Size) and '원본 크기 유지' (Maintain Original Size), and a '종이 크기' (Paper Size) dropdown menu set to 'A4'. At the very bottom are buttons for '확인' (OK), '취소' (Cancel), and '도움말' (Help). Blue callout boxes point to the '종이' tab, the 'A4' dropdown, the '표준 크기' radio button, the '원본 크기' checkbox, the '원본 크기 유지' checkbox, the '종이 크기' dropdown, and the '확인' button.

A4

( 1 2 3 )

( 1 2 3 )

모습



[Blue box pointing to the '주요 시계' title bar]

/	/

[Blue box pointing to the '주요 시계' title bar]

	( )

# 여러 가지 인쇄 환경 설정 하기

인쇄

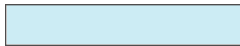

가

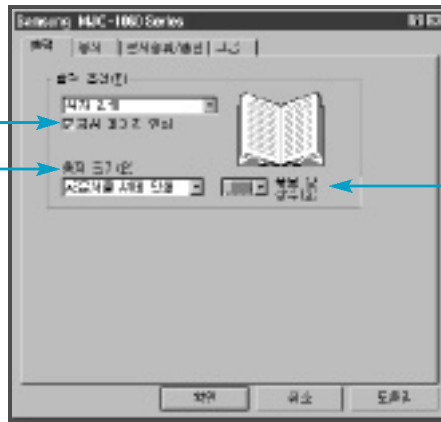

( )



A5 16 A4

2

- 1.
- 2.
3. 9~16
4. 2

2  
1~8

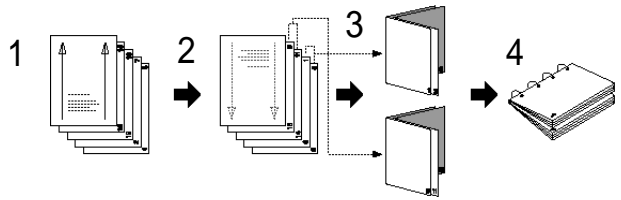

4

- 1.
- 2.
3. 4
- 4.

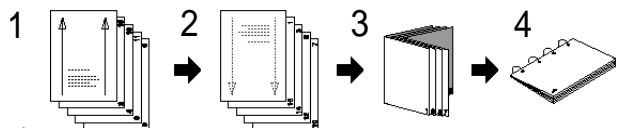

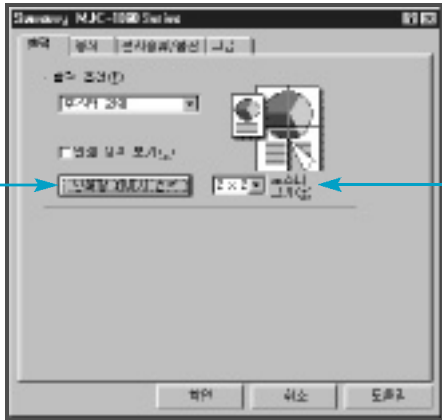

) 4X4  
가 4



가

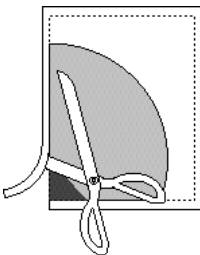

여러 가지 인쇄 환경 설정 하기



( )

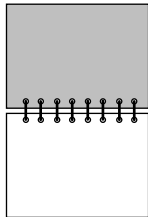
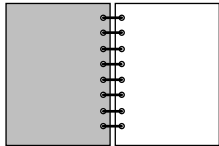

가

( )

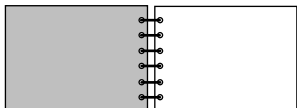
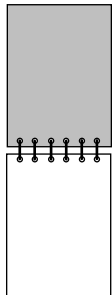

가



가



가

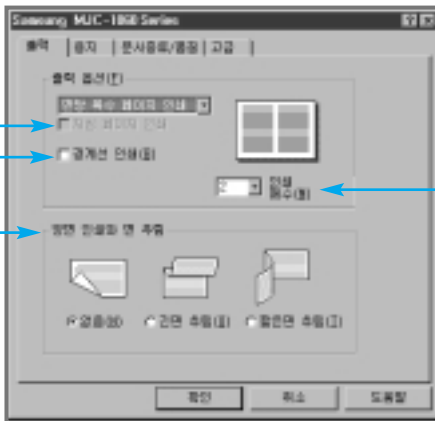
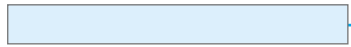

가

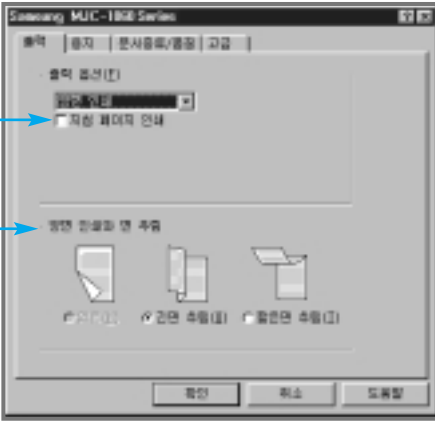



# 환경설정 화면을 여는 다른 방법

(3-2 )

95/98

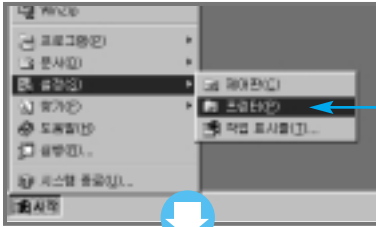

1

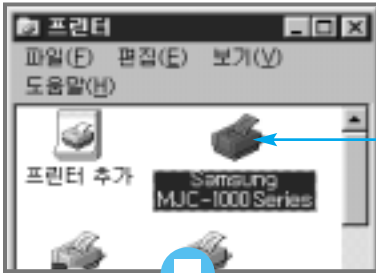

2



3



4

3-3 ~ 3-9

# 3.1

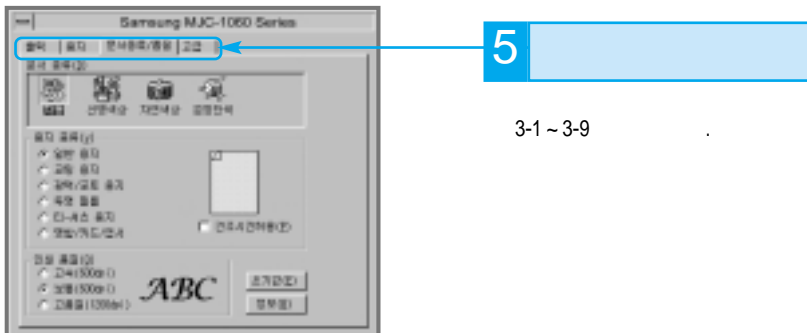
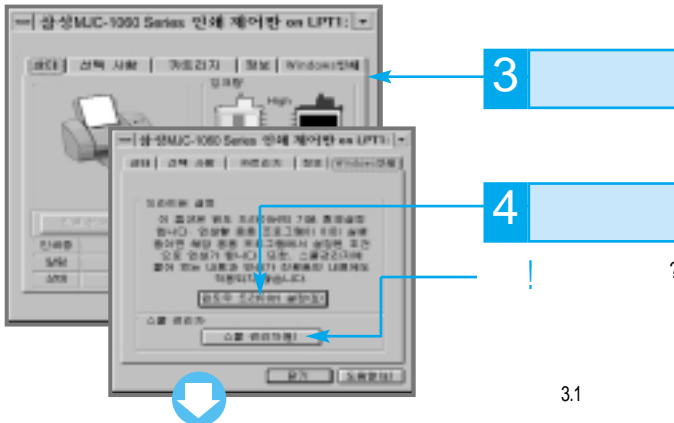
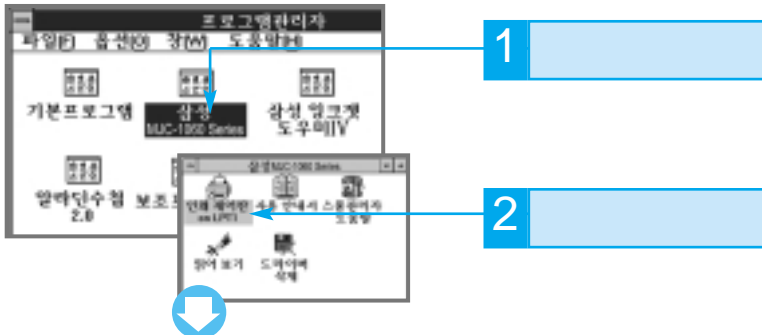

3.1

3-1 ~ 3-9





가

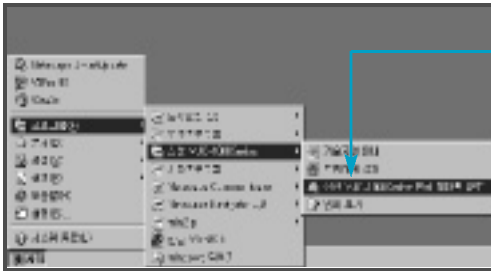

1 MJC-1060 Series on LPT1

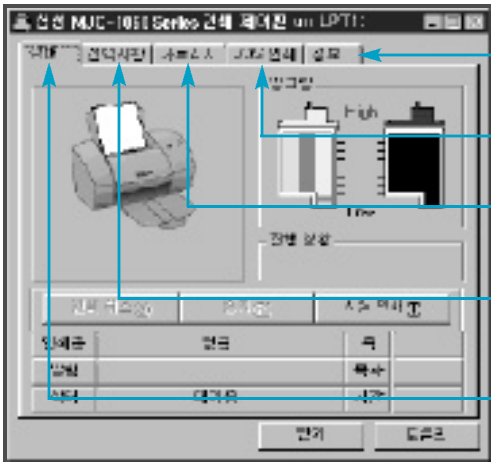

DOS

(3-16 )

(3-15 )

(3-14 )

# 3.1

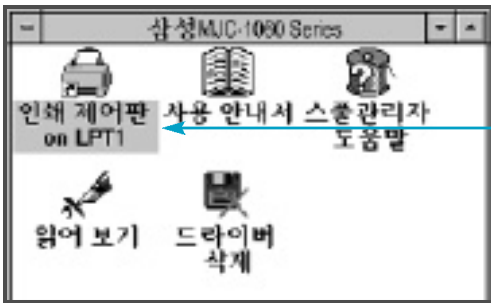

1 MJC-1060 Series on LPT1



[인쇄] 선택 사항 카드리지 정보 Windows 인쇄

인쇄 대기

(3-16 )

(3-15 )

(3-14 )

# 인쇄 제어판을 활용하려면

사진

( 3-12-3-13 )

The screenshot shows the printer's control panel software interface. The window title is "삼성 MJC-1060 Series 인쇄 제어판 on LPT1:". The interface includes a printer icon, a "인쇄" (Print) button, a "종기" (Paper) button, and a "시작" (Start) button. A table below these buttons displays printer settings:
 

인쇄종	얇은	표
발달		복사
속터	대기종	시간

 At the bottom are "닫기" (Close) and "도움" (Help) buttons. Annotations include:
 

- Three grey boxes on the left with arrows pointing to the printer icon, the "인쇄" button, and the "종기" button.
- Two grey boxes on the right with arrows pointing to the "High/Low" scale and the "진행 상황" (Progress) indicator.
- Another grey box on the right with an arrow pointing to the "복사" (Copy) button.

신택사양

3-12-3-13

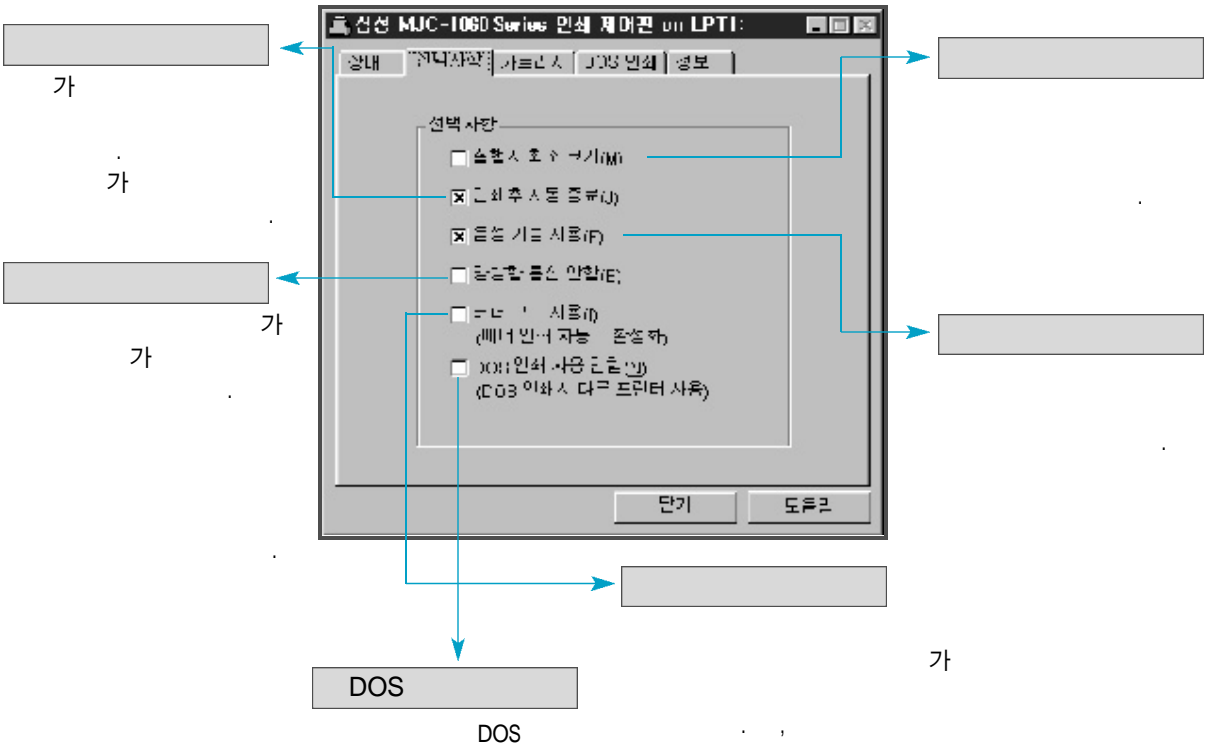

카트리지

( 3-12-3-13 )

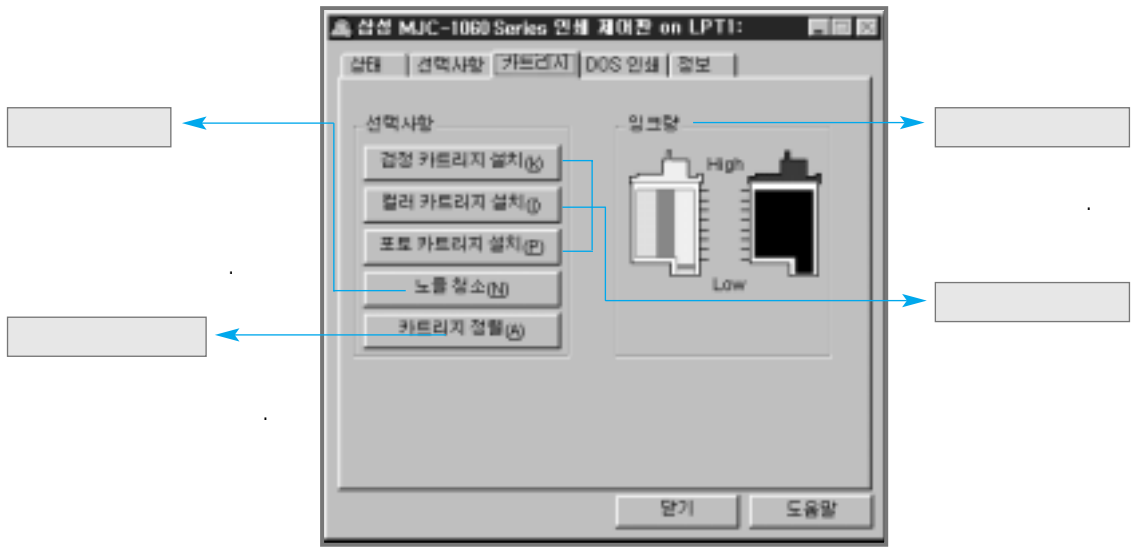

# 도스에서 사용방법

005

---

# 도스유틸리티 설치 후 인쇄를 하려면

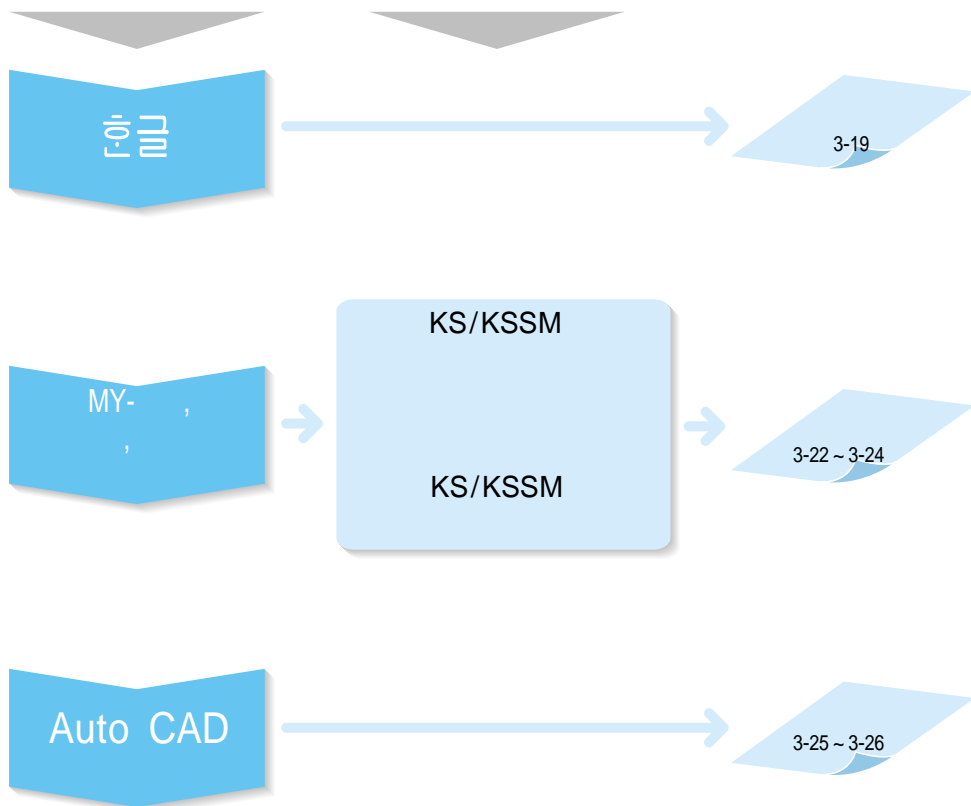

# 도스용 한글 에서 인쇄하려면

) 한글 3.0

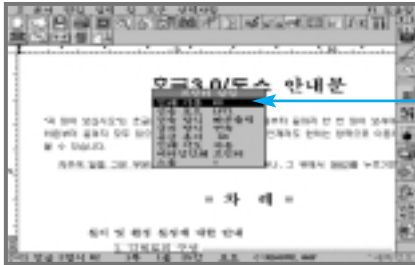

1 **<Ctrl> <P>**

2 **Enter**

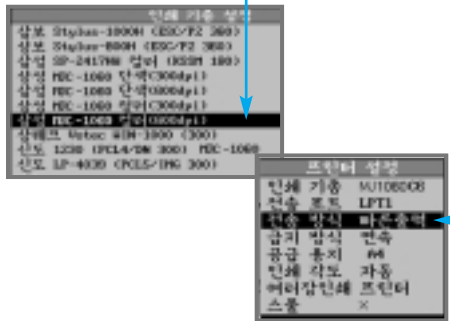

3 **Enter**

- MJC-1060 (300dpi) --
- MJC-1060 (600dpi) --
- MJC-1060 (300dpi) --
- MJC-1060 (600dpi) --

4 **Enter**

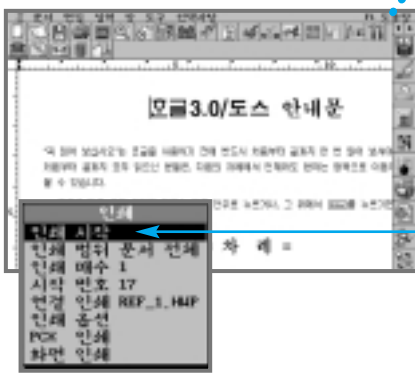

5 **<Esc>  
<Alt> <P>**

6 **<Enter>**



# 리모트 컨트롤 패널의 기본 메뉴 설정하기

C:\>myjetw\mjrcp

가

Enter

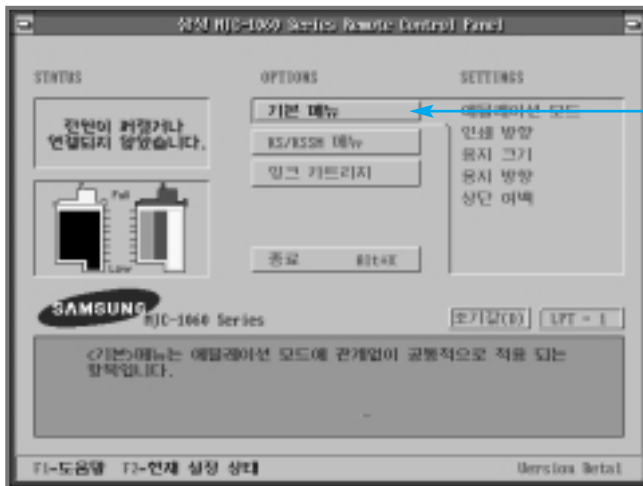

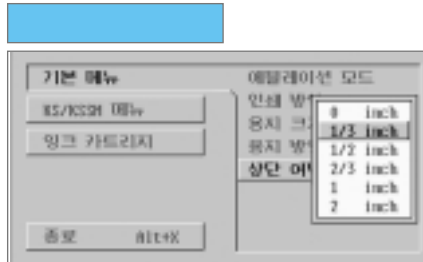
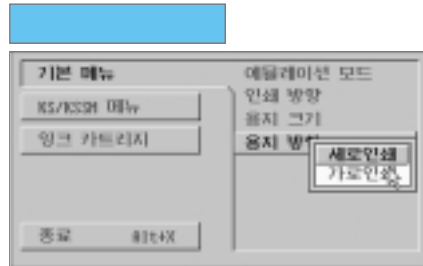
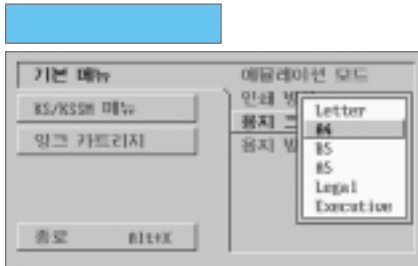
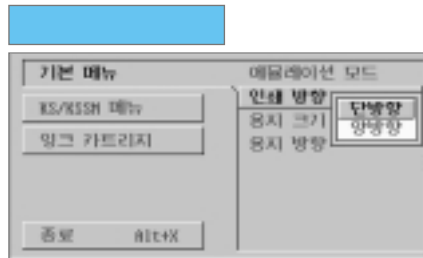
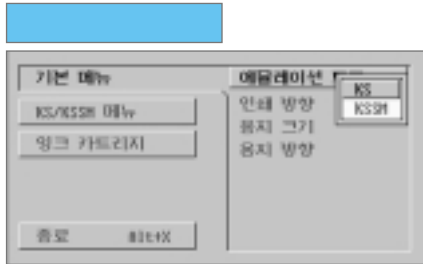

.(0 ~ 2inch)

# MY- 글꼴, 하나워드, 보석글 V 등에서 인쇄하려면



Enter

가  
가

KS      KSSM



KS      KSSM

KS  
MY- , Lotus1-2-3,  
MY WORKS, , MY SHEETS

KSSM  
V, MY- +, MY WORKS



(      3-20 ~ 21      )

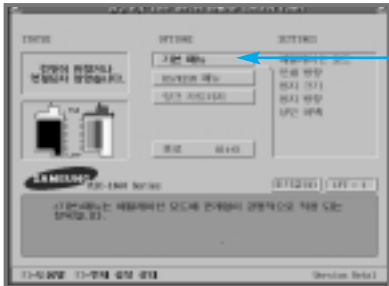

1

3-20 ~ 21

# KS/KSSM

KS/KSSM

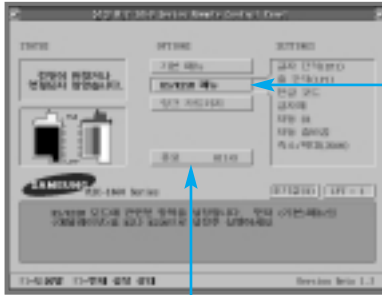

2 KS/KSSM

[Blue box]

1  
(10, 12,  
13.3, 15 CPI)

[Blue box]

1  
(6, 8 LPI)

[Blue box]

[Blue box]

CR

CR(Carriage Return)  
LF

(Line Feed)

CR  
LF

[Blue box]

3

KS/KSSM

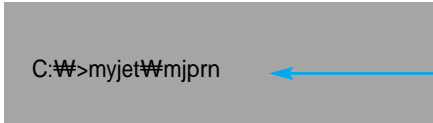

Enter

/

50% ~ 150%

KS/KSSM

KS/KSSM

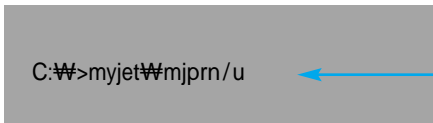

가 Enter



KS KSSM  
KS/KSSM 가  
, KS/KSSM  
KS/KSSM

80KB

가

# MY-글벳+, 하나워드, 보석글 V 등에서 인쇄하려면

KS/KSSM

가

(

,

.)

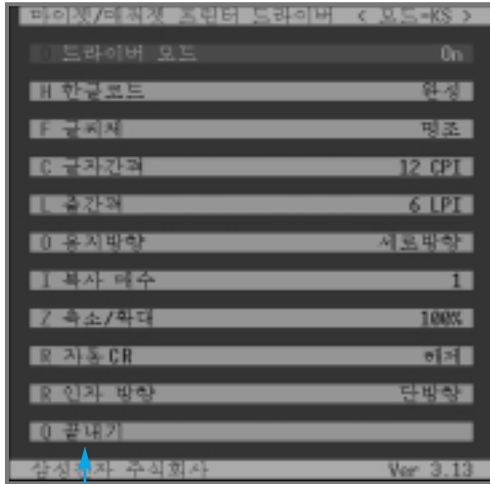

3

1 < Ctrl>+< Alt>  
+</>

2

,

1

,

(10, 12,

,

13.3, 15 CPI)

가

가

1

(6, 8 LPI)

(1 ~ 10)

/

50% ~ 150%

50% ~ 150%

CR

CR

CR(Carriage Return)

LF

LF

LF

CR

CR

LF

LF



KS/KSSM

# AutoCAD에서 인쇄하려면

## DOS AutoCAD

2-9

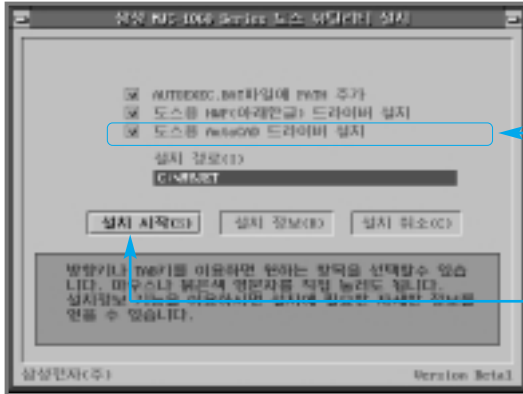

1

AutoCAD

2

## DOS AutoCAD(R11)

1. AutoCAD “ Main Menu ” 5 “ 5. Configure AutoCAD ”
2. “ Configure Menu ”가  
<Enter>
3. “ Configuration Menu ” “ 5. Configure plotter ”
4. 가  
Y
5. “ Available Plotters ” 2 “ 2. ADI P386 Plotter ”
6. “ Supported Model ” “ SAMSUNG MyJet Series ”
7. ‘ SAMSUNG MJC-1300G ’
8. “ DOS AutoCAD(R12/R13)  
(3-26 ) 5

## DOS AutoCAD(R12/R13)

### AutoCAD

### 가

1. (Command) config
2. "Configure Menu"가 <Enter>
3. "Configuration Menu" 5 "5. Configure Plotter"
4. "Plotter Configuration Menu" 1 "1. Add Plotter"
5. "Available Plotter Menu" "SAMSUNG MyJet Series"
6. 'Samsung MJC-1060 Series'
7. S(Serial) P(Parallel)
8. "Printing Color Mode" 0(Mono) 1(Color)
9. LPT1 LPT2
10. N
11. <Enter>
12. <Enter> "Main Menu"
13. <Enter>

### AutoCAD

1. AutoCAD "Plot"
2. "Device and Default Selection" "SAMSUNG MyJet Series"
- 3.

## AutoCAD

- (2-6~2-8 )
1. AutoCAD SYSTEM PRINTER 가 SYSTEM PRINTER
  2. PRINTER 가 SYSTEM PRINTER

# 특수용지에 인쇄하기







# 봉투, 엽서 등 두꺼운 용지에 인쇄하기

가

1

2

3

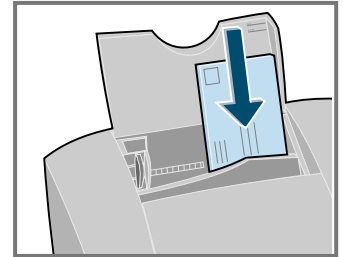

4

가

가

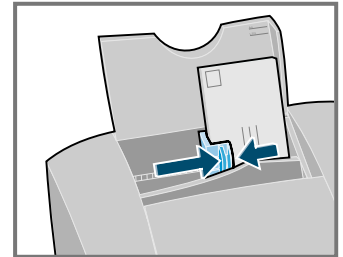

5

3-2

“ 7 3/4 ”

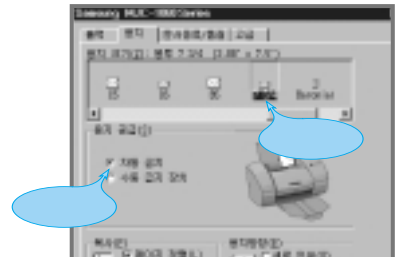

6

/  
“ / / ”

7



8

가

/



/ 가 가  
가



# 티-셔츠 용지에 인쇄하기

1

2

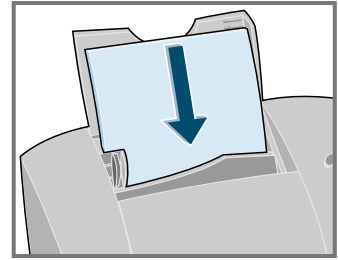

3 가 가

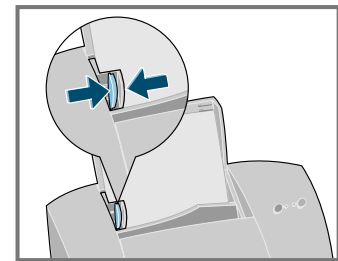

4

3-2



가

5

/  
“ - ”

6



7

가

8

-  
-  
가  
/



(A4)

( : P-SHIRTS)





# 패션(명함, 카드, 엽서) 용지에 인쇄하기

1

2

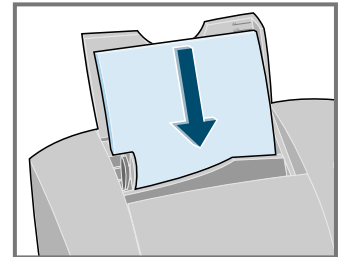

3 가 가

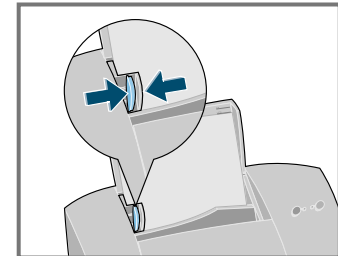

4

3-2



가

5

/  
“ / / ”

6



7

가

( : P-NAME)  
 ( : P-CARD2)  
 ( : P-POST)





# 라벨 용지에 인쇄하기

1

2

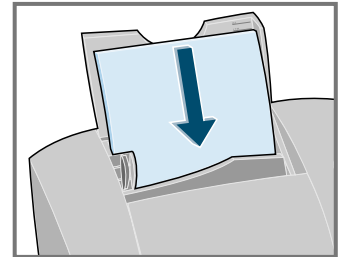

3

가

가

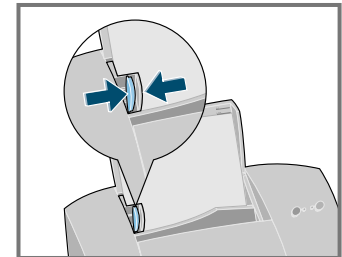

4

3-2

“ ”



가

5

/

“ ”

6



7

가

/



(A4, Letter)

가

가





# 배너 용지에 인쇄하기

1

2

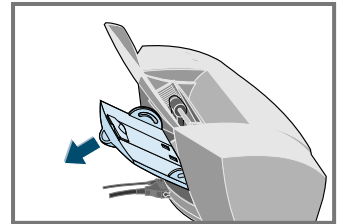

3

가

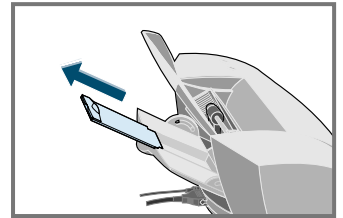

4

가

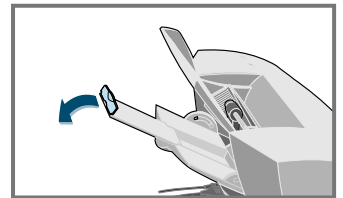

5

가

가

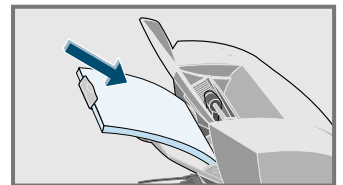

6

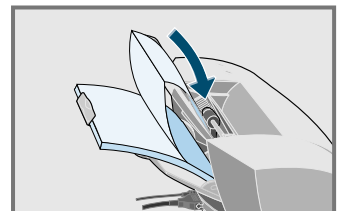

가

7 가

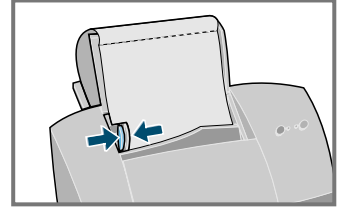

8

“ A4( A4) ”  
“ ”

3-2

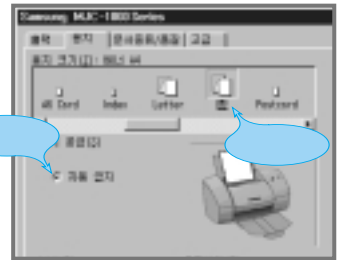

9

/  
“ ”



10

11

가

/



(A4)

( :P-BANNER)



# 기타 기능 사용방법

· USB

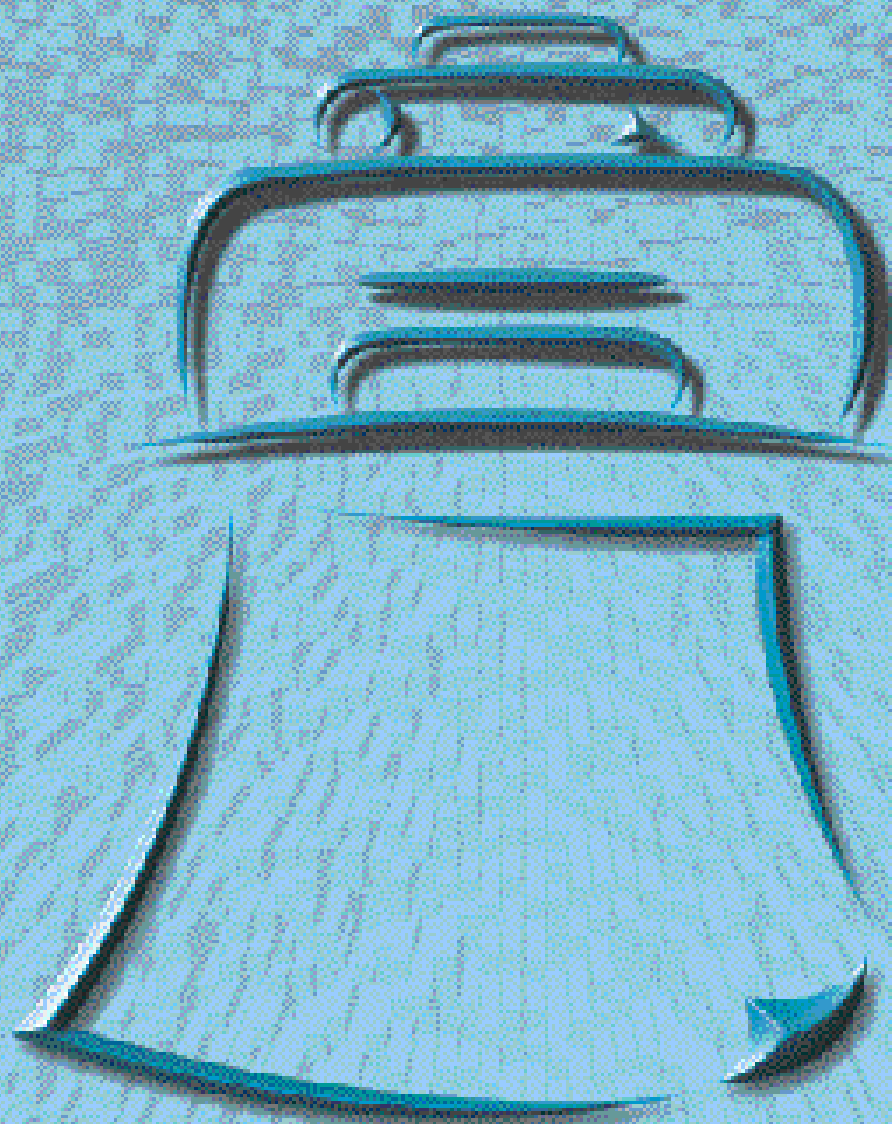

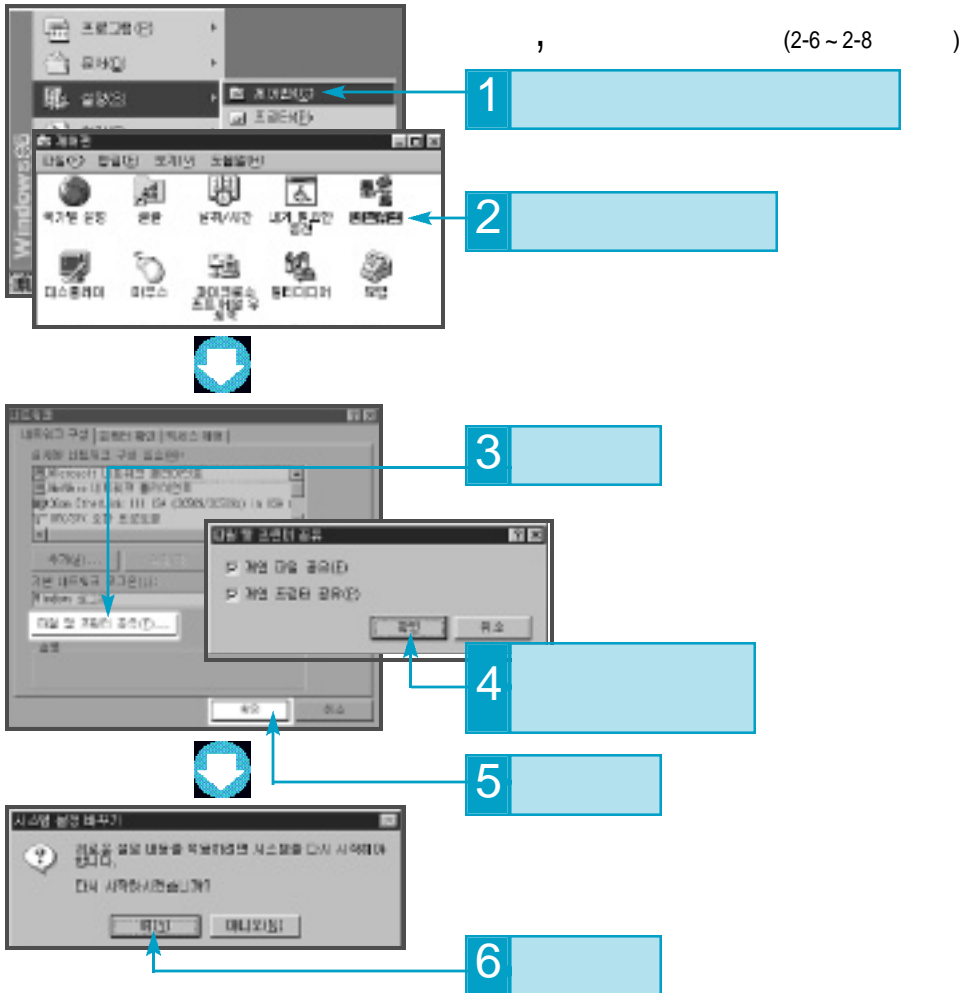

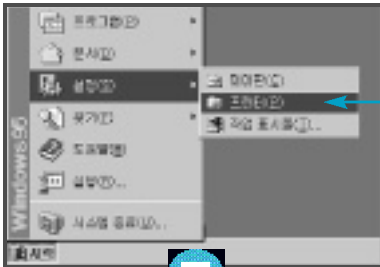

7



8



9

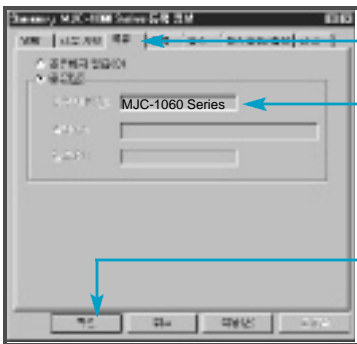

10

11 “ MJC-1060 Series ”

12

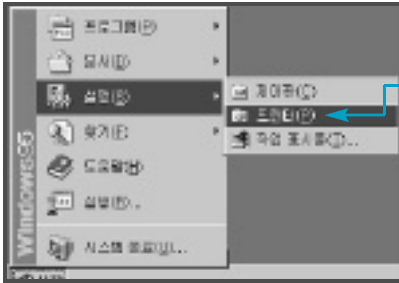

1 (2-6 ~ 2-8 )



2

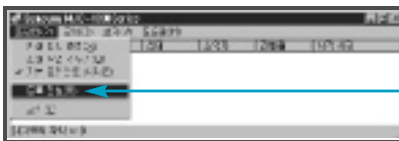

3

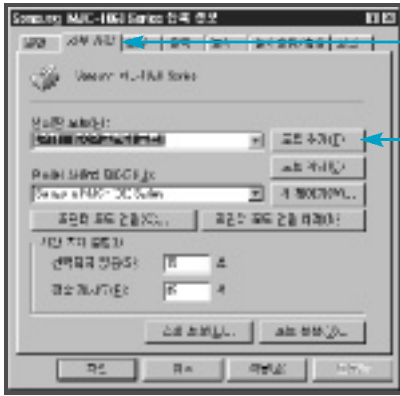

4

5

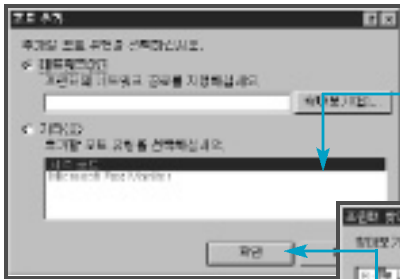

6



7

8



3-15



3.1



(2-6~2-8 )

1

2

3

4



5

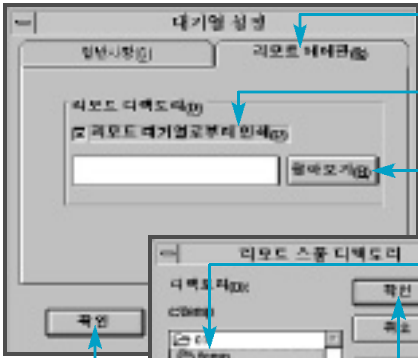

6

7

8

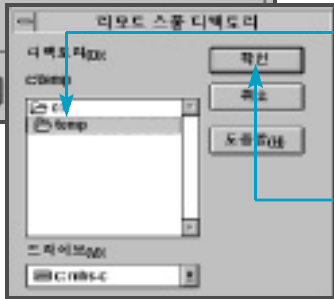

9 가

가

10 “ 가 ”

11



가

가

3.1



프로그램관리자 (2-6~2-8 )

1

2

3

4



5

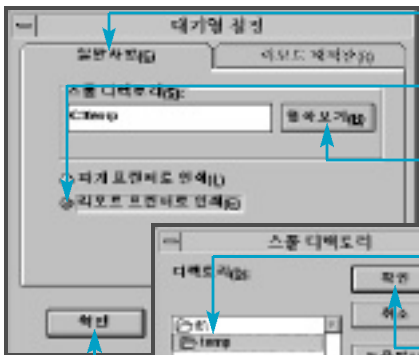

6

7

8

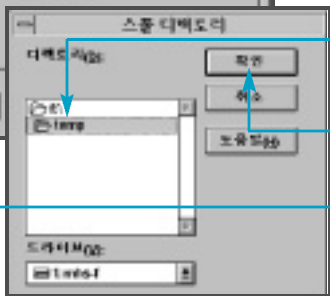

9

가

10

11



3-15



가

가



(.ATTA System K21 , K41 )



가

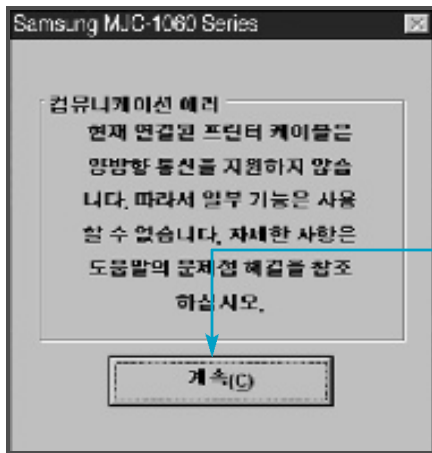

1

계속(C)

가

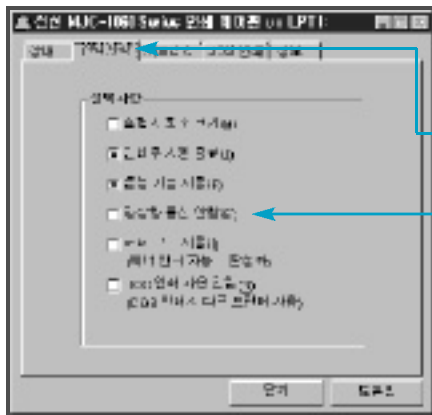

2 (3-12~3-13 )

3

4



# USB

USB ?  
98

USB

127

가



USB

USB 가

1

2-6 ~ 2-7  
USB

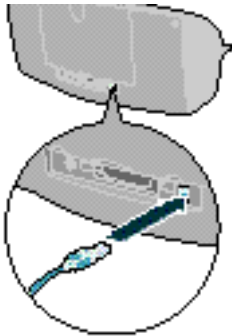

2

USB

3



USB

USB

USB

USB

가

4

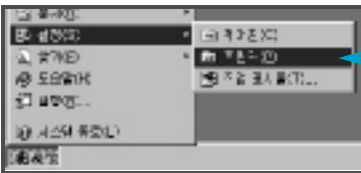

# USB



5

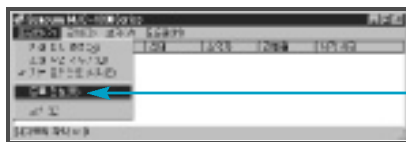

6

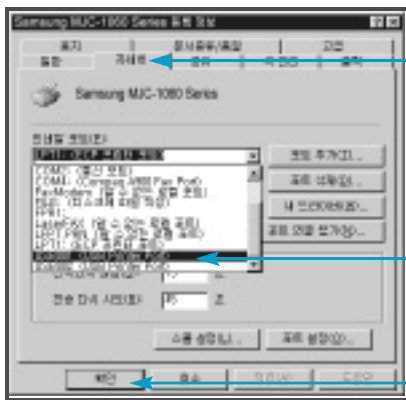

7

8

9



# 잉크 카트리지 청소하기

가

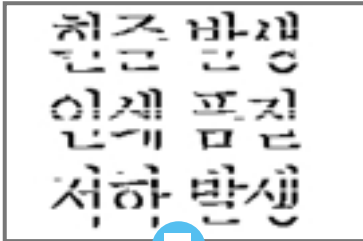

가

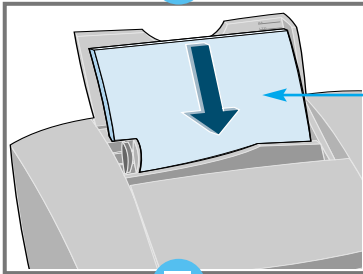
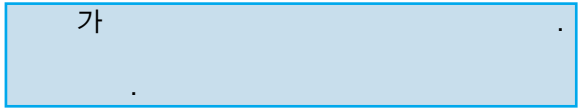

1

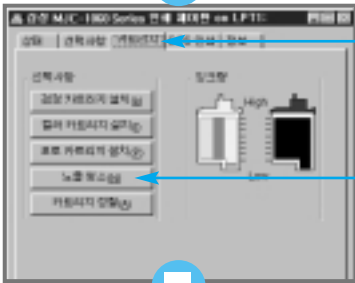
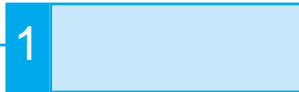

2

MJC-1060 Series  
on LPT1  
(3-12~3-13 )

3

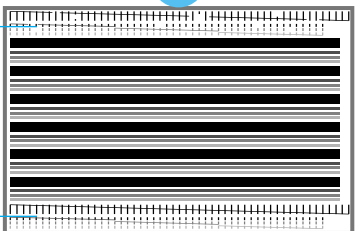
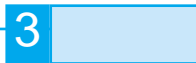

4

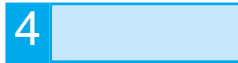

3

!

가

(4-2 ~ 4-3 )





# 잉크 카트리지를 청소하기

1

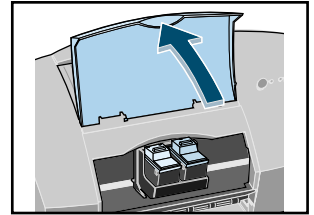

2

가

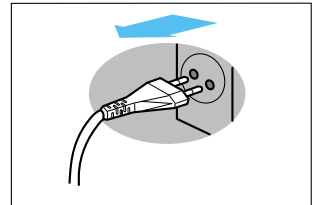

3

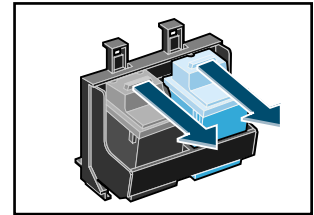

4

가

가

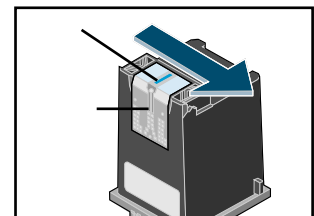

---

5

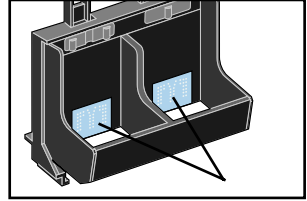

---

6

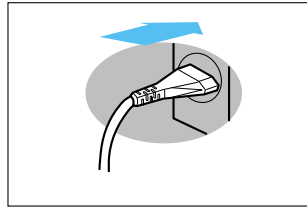

---

7

4-1

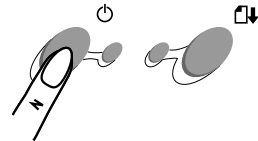

가

# 잉크 카트리지 정렬하기

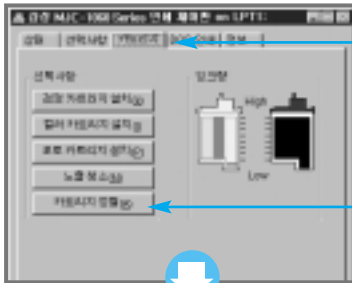
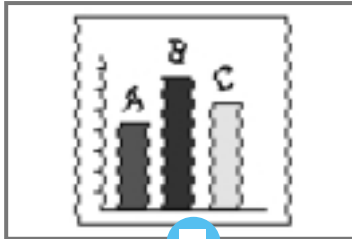

1 MJC-1060 Series  
on LPT1  
(3-12-3-13 )

2

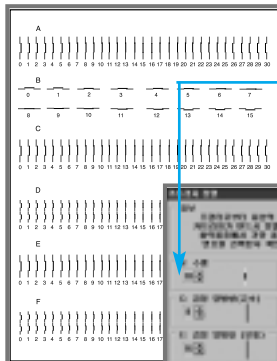

3

4

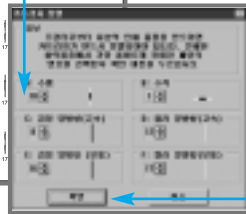

5

가  
확인

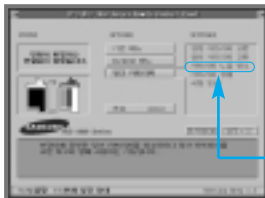

C:\wmyjet>mjrcp

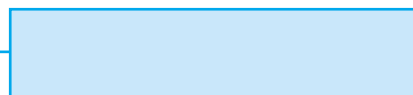



# 5. 안전을 위한 주의사항

가

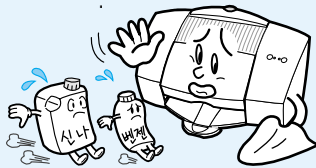
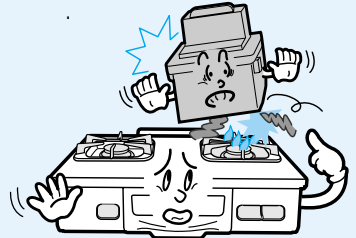
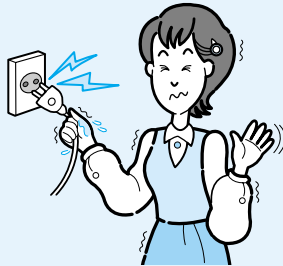
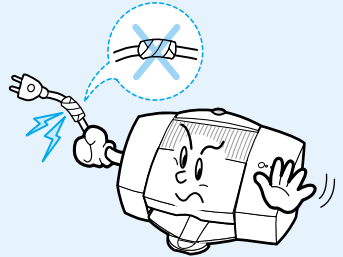

가



가

( )

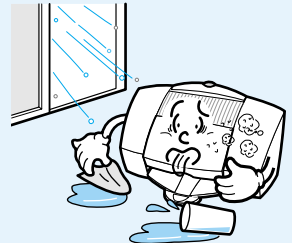
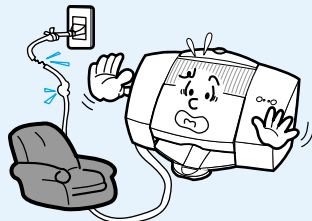

가

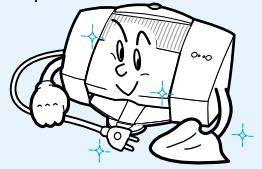
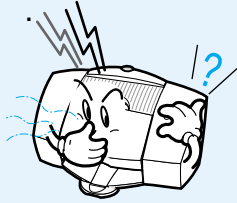

가

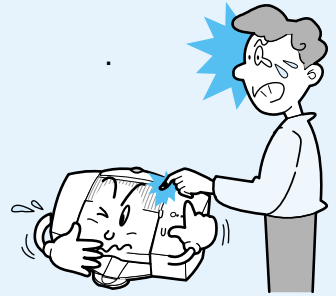
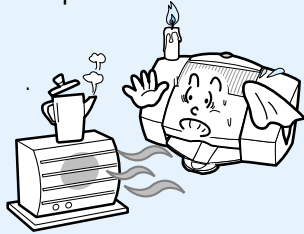

가

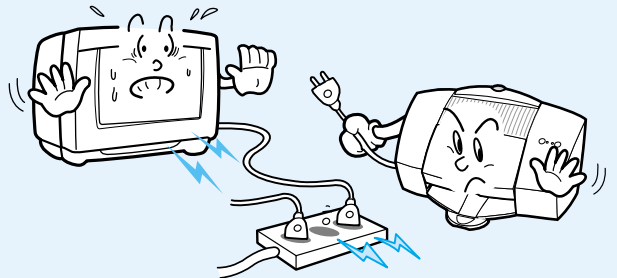
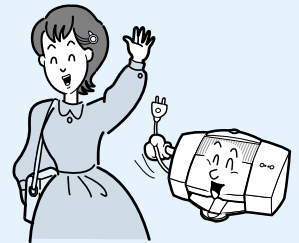

# 6. 문제점 및 해결편

 **어 왜 이러지!**

프린터에 이상이 생겼어요?

가

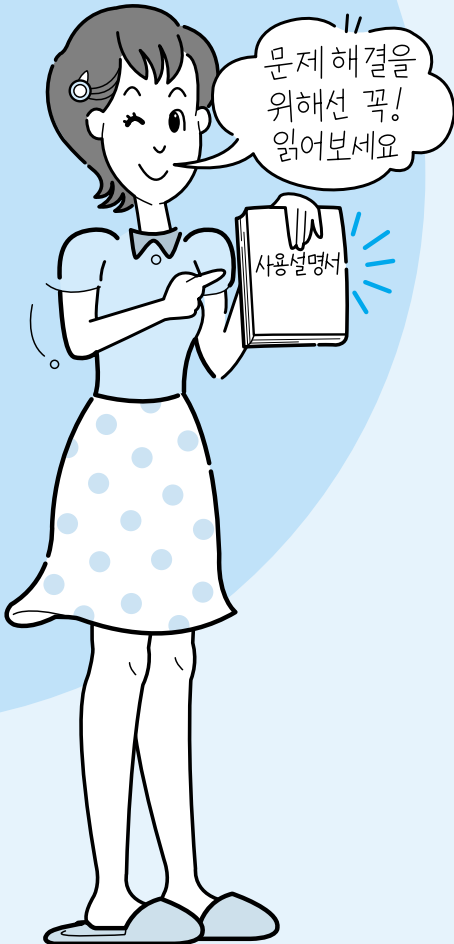

# 프린터가 동작되지 않아요?

.



1 가 ? (2-1 )  
 2 가 ?

가 .



1 가 ? /  
 3 가 ? ( , ) 2-4  
 ) ( , ) 3-28 ~ 3-37

가 .



1 ? (2-2 )  
 2 ? (4-1 )  
 3 가 ? (2-2 )

가 .



1 ? (2-1 ) 가  
 2 DOS KS/KSSM / KS/KSSM  
 (DOS / KS/KSSM  
 AutoCAD PCL (3-19 ~ 3-26 )  
 ) 가 ?  
 3 가 (6-1 )  
 ?



# 윈도우에서 인쇄가 잘 안돼요?

가

```

95/98
1) ' ' ' ' ' '
2) 'Samsung MJC-1060 Series'
3) ' ' ' ' ' '

3.1
1) ' ' ' ' ' '
2) Samsung MJC-1060 Series LPT1 ' ' ' '
3) ' ' ' ' ' '
  
```

가

```

' < >
' < >
' ,
  
```



```

( )
1) < >
' (A4) ' < >
? ' ' ' ' ' '
  
```

```

' 3.1
' ,
  
```



```

1) ?
-----
2) 3.1 가 386 가
-----
DOS 6.0
C:\>memmaker
3) DOS
C:\>ver
DOS
<Enter>
  
```

3.1



1 3.1 가 386 가

'



1 ?  
-----  
2 (2-1 )  
?

MJC-1060  
Series가



DOS  
MJC-1060  
1 ID)가 (DEVICE Series가 (R), (I), (C)  
(R)  
(DEVICE ID)가

# 윈도우에서 인쇄가 잘 안돼요?

AutoCAD  
가 .



MJC-1060 Series

(6-2 )

AutoCAD  
가 SYSTEM  
PRINTER 가

1 AutoCAD  
(3-25~3-26 )

SYSTEM PRINTER

'2'  
가 2



1 가 '1'

'2' ? (3-3 )

가 .



1 가 ? (6-2 )

---

2 3.1 Windows  
가

가  
가 가 .



1 가 (6-2 )

?

```
95 '
' 2
1
가 .
```



```
1 95 ' ' 1,1 2, 2 3, 3
' ' 1,2,3 1,2,3
.
```

```
가
가 .
```



```
1 가
Samsung LT56
Samsung LT56PV
5.38
?

-----

2

Samsung
LT56 Samsung LT56PV

LTMODEM.VXD
```

# 도스(DOS)에서 인쇄가 잘 안돼요?

DOS	DOS	KS/KSSM	' KS/KSSM
	'	가 가	(3-23 ~ 3-24 )
	DOS	KS/KSSM	
	'	가 가	

한글 가 .

한글 가



```

1 MJC-1060 Series.. <Ctrl><P>
?
MJC-1060 Series...'
(3-19 )
    
```

한글 (HWP) 2.1  
가 ' MJC-1060 Series 가  
가 .



```

1 KS/KSSM 가 C:\myjet\mjprn/u<Enter>
가 KS/KSSM
(3-23 )
    
```

한글 (HWP) 2.5  
가 .



```

1 한글 <Ctrl> <P> '
? ' (3-19 )
    
```

한글 2.5 <Ctrl>+  
<P>  
' MJC-1060 Series '  
가  
.



CD-ROM  
' DOS ' (2-9 )  
' 한글 ' (3-23 )  
?  
DOS  
' C:\MYJET\HWP\_DRV '  
' C:\HNC\DRV '  
.

가  
.



KS/KSSM KS/ KS/KSSM  
KSSM ? (3-23 )  
.

가 가  
가 가  
.



가 가  
가 가 ? (3-20 ~ 3-24 )  
.

가  
.



KS/KSSM 가 C:\>myjet\mjprn/u <Enter>  
? KS/KSSM  
(3-23 )  
.

# 도스(DOS)에서 인쇄가 잘 안돼요?

AutoCAD

가

AutoCAD(R11/R12/R13)  
가



```

      ' DOS
      ' ' DOS
      ' AutoCAD
      (R11/R12/R13) '
      (3-25 ~ 3-26 )
      -----
      AutoCAD
      가(Add Plotter)
      ' SAMSUNG
      ' Samsung
      Plotter ' SAMSUNG
      MyJet Series ' ?
      MJC-1060 Series '
      (3-25 ~ 3-26 )
    
```

AutoCAD(R11/R12/R13) ' SAMSUNG  
MJC-1060 Series '  
가  
가



```

      C:\>myjet\mjprn/u <Enter>
      KS/KSSM 가
      KS/KSSM ?
      (3-23 )
    
```

AutoCAD R10  
가



```

      AutoCAD
      가(Add Plotter)
      KS/KSSM
      KS/
      DOS
      AutoCAD R10
      KSSM
    
```

AutoCAD(R11/R12/  
R13) 가  
(Add Plotter)  
' SAMSUNG MyJet  
MJC-1060 Series '  
가



1 → DOS      ' DOS  
AutoCAD(R11/R12/R13)  
(X )  
(2-9 )

---

2 → DOS      ' C:\MYJET\ACAD \_ DRV '  
' plpmyjet.exp '      ' AutoCAD 가

DOS      KS/  
KSSM  
가  
?



1 → KS/KSSM      KS/KSSM  
가  
(3-23 ~ 3-24 )

DOS      KS/  
KSSM  
/  
?



1 → KS/KSSM      KS/KSSM  
(50 ~ 150%)  
(3-23 ~ 3-24 )



# 도스(DOS)에서 인쇄가 잘 안돼요?

가

KS/KSSM  
' XMS  
Error '



```

KS/KSSM
2MB
가
DOS 6.0
C:\memmaker
DOS C:\ver
<Enter>
    
```

MJC-1060  
Series가 . '



```

DOS
(MDEVICE 1060 Series가 MJC-
ID)가 (R), (I), (C)
(DEVICE ID)가 (R)
    
```

DOS



```

KS : MY- , Lotus 1-2-3,
, MY WORKS, , MY SHEETS
KSSM : V, MY- 1.5,
MY WORKS
    
```

# 용지 공급이 되지 않아요?

가

가  
가 .



1 ? 90 (9mm)

---

2 가 가 ? 가 (2-4 )

---

3 가 ?

---

4 가 ?

가  
가 .



1 가 가 ? 가

---

2 ? 90 (19mm)

---

3 가 ?

---

4 가 ?

# 용지 공급이 되지 않아요?

가  
가



1

?

90

(19mm)

2

가 가

?

가

3

,

가

?

4

) ( , 가 ?

1

(3-32 ~ 3-33 )

5

가 ?

1

(3-30 ~ 3-31 )



가

# 인쇄 상태가 좋지 않아요?



1 ? (4-1 )

---

2 가 ? (4-2 ~ 4-3 )

---

3 가 ? , 가

---

4 ? (2-2 )

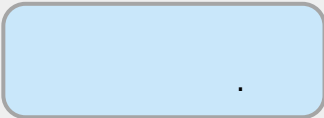

1 가 ? (4-4 )

---

2

(3-4 )

# 인쇄 상태가 좋지 않아요?

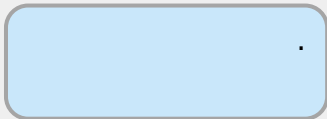

1 가 ? (3-4 ) /

2 ? 가

3 / (3-4 )

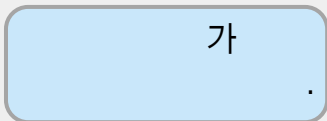

1 가 ? (3-4 ) /

2 ? 가

3 / (3-4 )

# 인쇄 속도가 너무 느려요?

가



2 > . , ? (3-4 )

---

3 > , ) ( ?

---

4 > ? 가

---

5 > (Screen Saver)가 ? 가

---

6 > ?



# 인쇄 여백이 이상해요?



1 ? 가  
(7-1 )

---

2 가  
?



1 ?  
(3-20 )



1 (LPI)  
? (LPI)  
(3-23 )

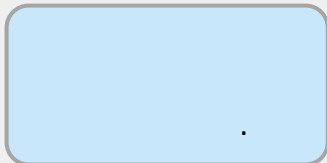

1 가 가 가  
?

---

2 ? 90  
(9mm)



# 인쇄 여백이 이상해요?

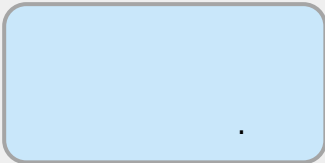

1

( ) , 가 ?

1

(3-32 ~ 3-33 )

2

- 가 ?

1

(3-30 ~ 3-31 )

3

( )  
가 ?

(A4)

(3-36 ~ 3-37 )

4

가 가 ?

가

# 네트워크 또는 공유기로 인쇄할 수 있나요?

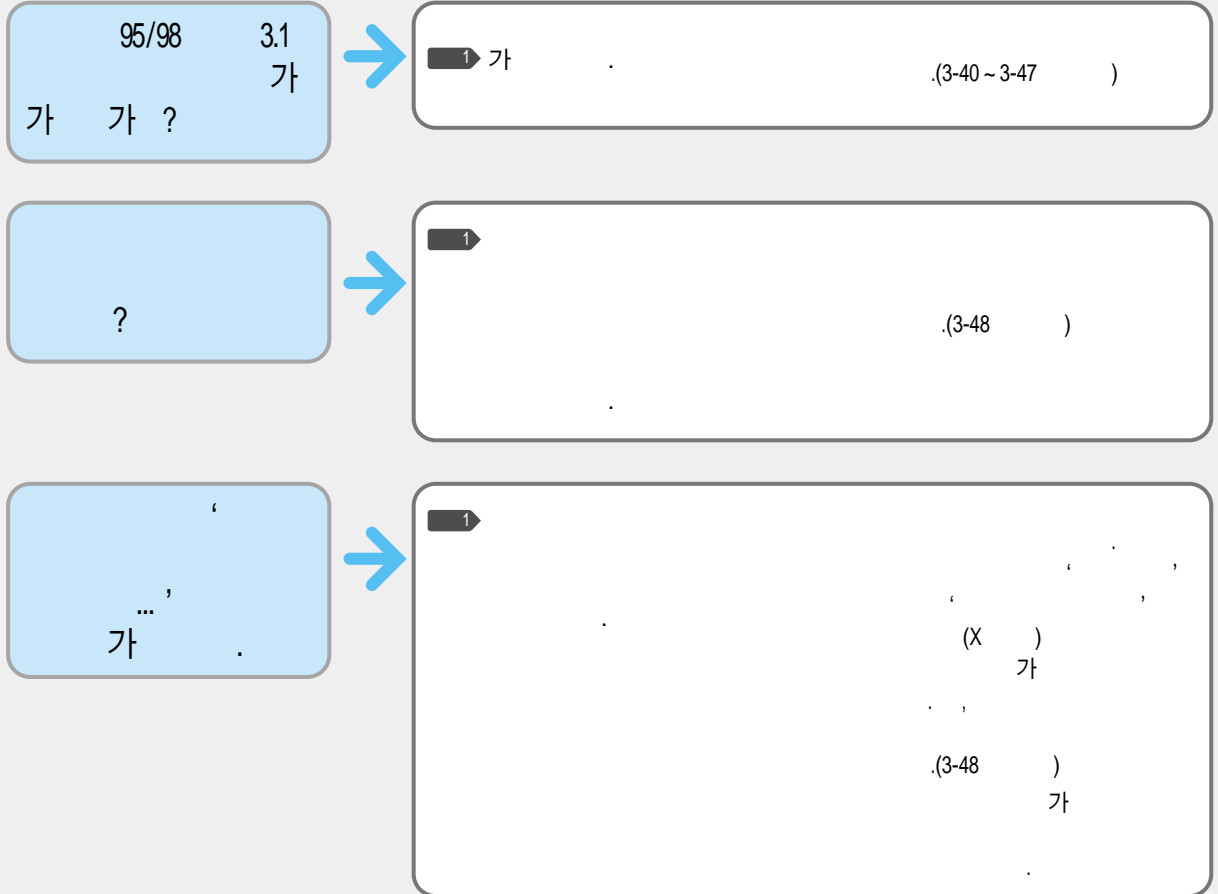

# 초기값/기타

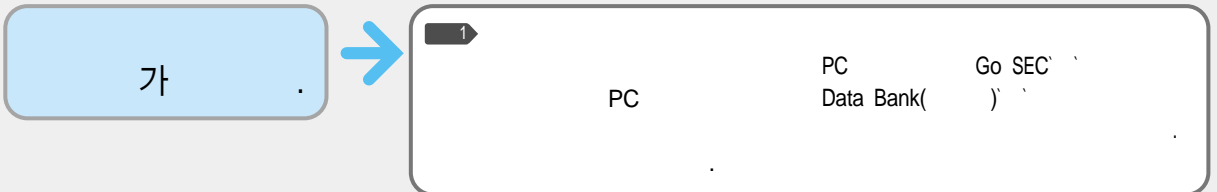
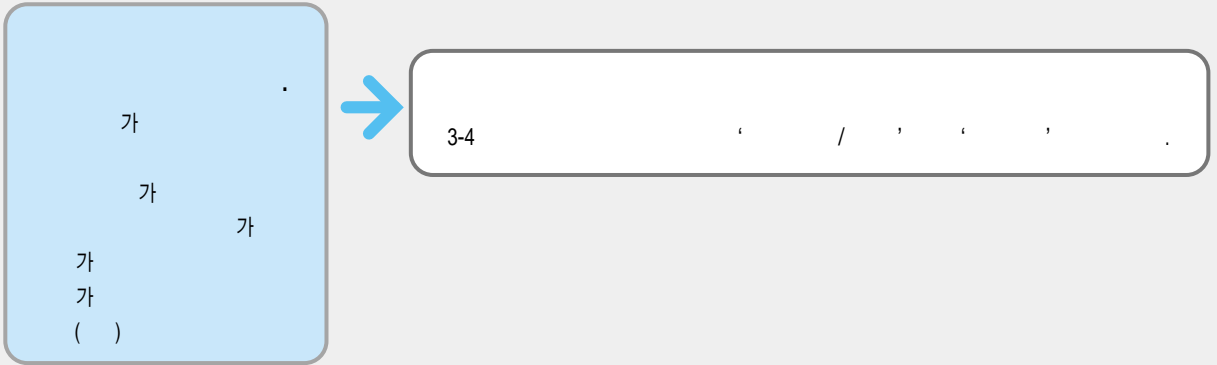

가 . 가



1 on LPT1  
 \XX  
 ?  
 XX  
 가  
 DOS  
 가

USB 가 .



1 98 USB 98  
 ?  
 2 BIOS USB BIOS USB가 enable  
 가 enable  
 ?  
 3 USB 1. USB  
 ? 2.  
 3.  
 4. USB

? .





# 7. 제품사양

모델명 : MJC-1060 Series

DOS ( )		(Draft)	(LQ)	KS KSSM KS KSSM	
		600CPS	300CPS		
		400CPS	200CPS	IEEE 1284	
	10CPI,	13.3CPI	USB( 98 )		
		(Draft)	(LQ)	RAM : 512K Byte	
		7.5PPM	5PPM	: Courier, CG Times, Letter Gothic	
		4PPM	2PPM	: , , ,	
( × )	DOS(KS/KSSM AutoCAD)		KS/KSSM AutoCAD		
	KS/KSSM AutoCAD		300 × 300DPI		
	DOS ( 21 가 )		KS/KSSM		
	300DPI	600DPI	10, 12, 13.3, 15 CPI		
	300 × 300DPI	600 × 600DPI	1- 2- , KSC 5601		
	300 × 600DPI	600 × 600DPI	1200 × 1200DPI		

(OHP),  
( )

	( × )
A4	210.0mmX297.0mm
Letter	215.9mmX279.4mm
Legal	215.9mmX355.6mm
B5	182.0mmX257.0mm
A5	148.0mmX210.0mm
Executive	184.2mmX266.7mm
A6	105.0mmX148.5mm
Index	76.2mmX127.0mm
Hagaki	100.0mmX148.0mm
	101.6mmX152.4mm

	( × )
#6 3/4	92.1mmX171.45mm
#7 3/4	98.6mmX190.5mm
#9	98.6mmX225.6mm
#10	104.8mmX241.3mm
DL	110.0mmX220.0mm
C5	162.0mmX229.0mm
C6	114.0mmX162.0mm
B5	176.0mmX250.0mm
Baronial	143.0mmX111.3mm

90 ( 9mm)

1

75g/m<sup>2</sup> ~ 90g/m<sup>2</sup>(20lb ~ 24lb)

220V ~ 240V

60Hz

: 10W

: 25W

460mm	467mm	326mm	
460mm	293mm	218mm	

4.0Kg( )

45dB(A) (ISO 9296)



# 제품사양

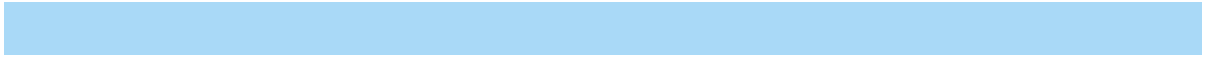

	10 ~ 40		8% ~ 80% RH
	15 ~ 35		10% ~ 70% RH
	10 ~ 52		



			: 208
			: 192 (Cyan, Magenta, Yellow 64 )

# 용지사양 (인쇄 가능 영역)

가

가

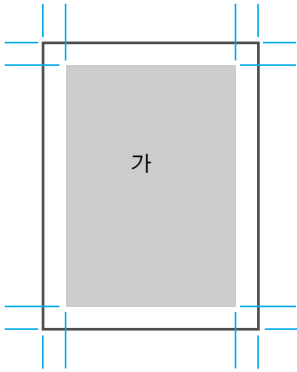

	( )	/	
A4	1.7mm	12.7mm	3.4mm
Letter	1.7mm	12.7mm	6.3mm
Legal	1.7mm	12.7mm	6.3mm
B5	1.7mm	12.7mm	3.4mm
A5	1.7mm	12.7mm	3.4mm
Executive	1.7mm	12.7mm	3.4mm
A6	1.7mm	12.7mm	3.4mm
Index	1.7mm	12.7mm	3.4mm
Hagaki	1.7mm	12.7mm	3.4mm

DOS

0mm

19mm

가

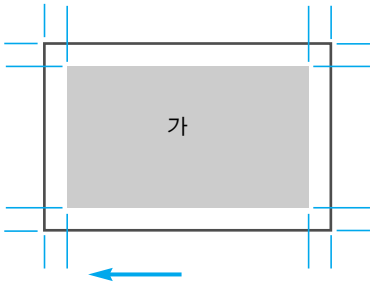

	( )	/	
#6 3/4	1.7mm	12.7mm	6.3mm
#7 3/4	1.7mm	12.7mm	6.3mm
#9	1.7mm	12.7mm	6.3mm
#10	1.7mm	12.7mm	6.3mm
DL	1.7mm	12.7mm	6.3mm
C5	1.7mm	12.7mm	6.3mm
C6	1.7mm	12.7mm	6.3mm
B5	1.7mm	12.7mm	6.3mm
Baronial	1.7mm	12.7mm	6.3mm

19mm



# 8. 소모품 구입/서비스에 관하여

	INK-M50	080-023-8484( ) 가 C&C A/S	
	INK-C60		
	INK-P50		
(A4/200 )	A4-MJ/SIJ		
(A4/50 )	OHP-MJ/SIJ		
- (A4/10 )	P-SHIRT		
(A4/100 )	P-BANNER		
(A4/50 )	P-NAME		
(A4/50 )	P-CARD2		
(A4/50 )	P-POST		

6

가

가

(4-1 )

가

정 오 표

3-49 가

USB ?

98 127 USB 가  
USB USB 가

6-19

?



1

(3-48 )

3-48

ATTA System 'ATA 200'  
가 가

ATTA System K21 , K41

6-21 가

USB  
가



1 98 USB 98  
?

2 BIOS BIOS USB가  
USB가 enable enable  
?

3 USB 1. USB  
?  
2.  
3.  
4. USB

# 제품보증서

서비스에  
대하여

( )

14

7

1  
5

		SERIAL NO.	

1 ( )

10			
1			
가	3		
	4		
가	( )	가	가
가	( )	가	가 10% 가

( 가 가 )

( )	1 2
	1

)110V 220V

( ) ( )

SAMSUNG

삼성전자

# 삼성전자주식회사

:

259

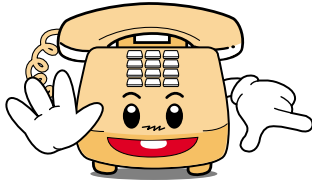

1588-3366

가

- |               |               |
|---------------|---------------|
| 02-3451-3366  | 051-550-3366  |
| 0391-652-3366 | 0652-240-3366 |
| 053-430-3366  | 062-250-3366  |
| 042-480-3366  | 064-742-3366  |



02-541-3000 080-022-3000  
051-861-3000 080-051-3000



PC  
PC ( )  
GO SEC( , , , )



Internet  
<http://www.sec.co.kr/printer>



AS ? 가 가