

LCD Projector

Owner's Instructions

The color and the appearance of the product may differ from the illustrations in this manual. The specifications are subject to change without prior notice to improve performance.



Table Of Contents

MAJOR SAFETY PRECAUTIONS

Before You Start	1-1
Care and Maintenance	1-2
Safety Precautions	1-3

INSTALLATION AND CONNECTION

Package Contents	2-1
Installing the Projector	2-2
Leveling with Adjustable Feet	2-3
Zoom and Focus Adjustment	2-4
Screen Size and Projection Distance	2-5
Lamp Replacement	2-6
Rear Side	2-7
Supported Display Modes	2-8
Connecting the Power	2-9
Connecting with a PC and Setting up the PC	2-10
Connecting a PC using an HDMI/DVI cable	2-11
Connecting an HDMI-Compatible Device	2-12
Connecting an AV device using a D-Sub cable	2-13
Connecting an AV device with Component output	2-14
Connecting using a Video cable	2-15
Connecting an External Speaker	2-16
Kensington Lock slot	2-17

USING

Product Features	3-1
Front, Upper	3-2
Remote Control	3-3
LED Indications	3-4
Using the Screen Adjustment Menu (OSD: On Screen Display)	3-5

TROUBLESHOOTING

Before Requesting Service	4-1
---------------------------------	-----



MORE INFORMATION

Specifications	5-1
RS232C Command Table	5-2
Contact SAMSUNG WORLDWIDE	5-3
Correct Disposal - Europe only	5-4

1 Major Safety Precautions

1-1 Before You Start

Icons used in this manual

ICON	NAME	MEANING
	Caution	Indicates cases where the function may not work or the setting may be canceled.
	Note	Indicates a hint or tip to operate a function.

Using this Manual

- Make yourself fully aware of the safety precautions before using this product.
- If a problem occurs, refer to the 'Troubleshooting' section.

Copyright Notice

The contents of this manual are subject to change without prior notice for performance improvement.

Copyright © 2010 Samsung Electronics Co., Ltd. All rights reserved.

The copyright of this manual is reserved by Samsung Electronics, Co., Ltd.

The contents of this manual may not be partially or in whole reproduced, distributed or used in any form without the written permission of Samsung Electronics, Co., Ltd.

1-2 Care and Maintenance

Cleaning the Surface and the Lens

Clean the projector using a soft dry cloth.

- Avoid cleaning the product with a flammable substance such as benzene or thinner.
- Avoid scratching the lens with your fingernails or a sharp object. This may result in scratches or damage to the product.
- Avoid cleaning the product with a wet cloth or by directly spraying water onto the product. If water enters the product, it may result in fire, electric shock, or a problem with the product.
- A white stain may appear on the surface of the projector if water gets on it.

 The appearance and the color may differ depending on models.



Cleaning Inside the Projector

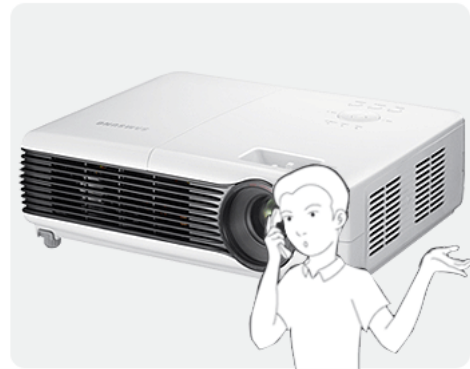

For cleaning the interior of the projector, contact an authorized Samsung Service Center.

- Contact a Service Center if dust or other substances are inside the projector.



1-3 Safety Precautions

Icons used for safety precautions

ICON	NAME	MEANING
	Warning	Failing to follow the precautions marked with this sign may result in a serious injury or even a fatality.
	Caution	Failing to follow the precautions marked with this sign may result in a personal injury or property damage.

Meaning of Signs



Do not perform.



Must be followed.



Do not disassemble.



The power plug must be unplugged from the wall outlet.



Do not touch.



Must be grounded to prevent electric shock.

Power Related

-  The following images are for your reference and may differ depending on models and countries.
The appearance and the color may differ depending on models.

Warning



Plug the power plug in firmly.

- Otherwise, it may result in fire.

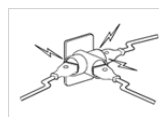

Avoid connecting multiple electric appliances to a single wall outlet.

- Otherwise, it may result in fire due to overheating of the wall outlet.

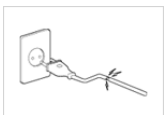

Avoid using a damaged power cord or plug or a loose power outlet.

- Otherwise, it may result in electric shock or fire.



Avoid bending or twisting the power cord excessively and avoid placing heavy objects on the cord.

- Otherwise, it may result in electric shock or fire due to a damaged power cord.



Avoid plugging in or unplugging the power supply with wet hands.

- Otherwise, it may result in electric shock.



To move the product, turn the power off and unplug the power cord and any other wires connected to the product.

- Otherwise, it may result in electric shock or fire due to the damaged power cord.



Make sure to connect the power cord to a grounded wall outlet (for insulation class 1 equipment only).

- Otherwise, it may result in electric shock or injury.

Caution



When unplugging the power plug from the wall outlet, make sure to hold the power plug by the plug and not by the cord.

- Failing to do so may result in electric shock or fire.



Unplug the power plug before cleaning the product.

- There is a danger of electric shock or fire.

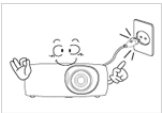

Connect the power plug to a wall outlet that can be easily reached.

- When a problem occurs with the product, you must unplug the power plug to cut the power off completely. You cannot cut the power off completely using only the power button on the product.



Do not turn the product on or off by plugging or unplugging the power plug. (Do not use the power plug as a power switch.)

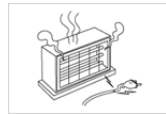

Keep the power cord away from sources of heat.

Installation Related

Warning



Avoid installing the product in a location exposed to direct sunlight and installing the product near a heat source such as a fire or heater.

- This may shorten the product life cycle or cause fire.



Avoid installing the product in a badly-ventilated location such as inside a bookshelf or closet.

- Otherwise, it may result in fire due to internal overheating.



When installing the product in a cabinet or shelf, take care so that the front end of the product is completely supported by the cabinet or shelf.

- Failing to do so may result in the product falling and resulting in damage to the product or injury.
- Make sure to use a cabinet or shelf suitable to the size of the product.



When installing the product on a console or shelf, make sure that the front of the product does not protrude out of the console or shelf.

- Otherwise, this may cause the product to fall off and result in a malfunction or injury.



Keep the power cord away from heaters.

- The coating of the power cord may melt and cause electric shock or fire.



When thunder or lightning occurs, unplug the power cord.

- Failing to do so may result in electric shock or fire.

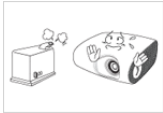

Do not install the product in a location exposed to dust, moisture (sauna), oil, smoke or water (rain drops) and do not install it in a vehicle.

- This may result in electric shock or fire.



Do not install the product in areas with heavy dust.

Caution



Take care not to block the vent with a table cloth or curtain.

- Otherwise, it may result in fire due to internal overheating.



Do not let the product drop while moving it.

- This may result in a problem with the product or injury.



When putting the product down, place it gently.

- Failing to do so may result in a problem with the product or injury.



Do not install the product at a height where children may reach it.

- If a child touches the product, the product may fall and this may result in injury.

Usage Related



Avoid inserting metal objects such as a chopsticks, coins or hairpins, or inflammable objects into the product (the vents, ports, etc).

- If water or an alien substance enters the product, turn the power off, unplug the power cord and contact a service center.
- Otherwise, it may result in a problem with the product, electric shock or fire.



Do not let children place objects such as toys or cookies on the product.

- If a child tries to reach for any of these objects, the product may fall and cause harm.



Do not disassemble, or attempt to fix or modify the product.

- When the product requires repairs, contact a Service Center.

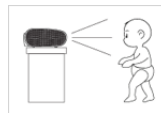

Do not look directly at the light of the lamp nor project the picture into someone's eyes.

- This is dangerous, especially for children.



Avoid using or placing inflammable spray or objects near the product.

- This may result in an explosion or fire.



When you remove batteries from the remote, be careful that they are not swallowed by children. Keep batteries out of the reach of children.

- If swallowed, see a doctor immediately.



Avoid placing a liquid container such as a vase, flowerpot, beverage, cosmetics or drugs, or a metal object over the product.

- If water or an alien substance enters the product, turn the power off, unplug the power cord and contact a service center.
- Otherwise, it may result in a problem with the product, electric shock or fire.

 **Caution**



If the product generates a strange noise, a burning smell, or smoke, unplug the power plug immediately and contact a service center.

- Failing to do so may result in electric shock or fire.



If the power plug pin or jack is exposed to dust, water or alien substances, clean it thoroughly.

- There is a danger of electric shock or fire.



When cleaning the product, disconnect the power cord and clean the product with a soft dry cloth.

- Avoid using chemicals such as wax, benzene, alcohol, thinner, mosquito-repellent, fragrance, lubrication or cleansing agent when cleaning the product.

This may result in the exterior being deformed or the print being removed.



When not using the product for a long time, such as leaving your home, unplug the power cord from the wall outlet.

- Otherwise, it may cause dust accumulation and result in fire caused by overheating or a short circuit or result in an electric shock.



If the product is installed in a location where the operating conditions vary considerably, a serious quality problem may occur due to the surrounding environment. In this case, install the product only after consulting our Call Center.

- Places exposed to microscopic dust, chemicals, too high or low temperature, high humidity, such as airports or stations where the product is continuously used for a long time etc..



If you drop the product or the case is damaged, turn the power off and unplug the power cord. Contact a service center.

- Failing to do so may result in fire or electric shock.



Make sure to place your remote control on a table or desk.

- If you step on the remote control, you may fall and hurt yourself or the product may be damaged.



If water or a foreign substance enters the product, turn the product off, unplug the power cord from a wall outlet, and contact a Service Center.



Do not use the product while it indicates a malfunction, such as no sound or no picture.

- Turn the product off immediately, unplug the power cord from a wall outlet, and contact a Service Center.



When a gas leak occurs, do not touch the product or the power plug and ventilate immediately.

- A spark may result in an explosion or fire.
- During a thunder or lighting storm, do not touch the power cord or antenna cable



Do not touch the lens on the product.

- This may cause damage to the lens.



Do not touch any outer part of the product with tools such as a knife or a hammer.



To clean dirt or stains on the front projection lens, use spray or a wet cloth dampened with neutral detergent and water.



Ask a Service Center to clean the interior of the projector at least once per year.



To avoid burning yourself, do not touch the vents or lamp cover while operating or right after turning off the product.



Do not clean the product using water spray or a wet cloth. Avoid using any chemicals such as detergents, industrial or automotive polish, abrasive, wax, benzene, alcohol on any plastic part of the product such as projector case, since this may cause damage.



Do not open any cover on the product.

- This would prove hazardous because of high-voltage current inside the product.



Do not use any undesignated battery.



Be careful not to touch the ventilation hole while the projector is on as hot air comes out.



The ventilation hole is hot for some time though the projector is turned off. Keep your hands or body off the ventilation hole.



Do not place objects vulnerable to heat near the projector.



Be careful to keep your body away from the projector lamp. The lamp is hot.

(Children and those who have sensitive skin should be more careful.)



Take care not to lose the lens cover of the product.

- The lens could get damaged.



- The lens cover protects the lens and should be used when the projector is turned off.

- To hide the screen while the projector is turned on, use the BLANK feature.

2 Installation and Connection

2-1 Package Contents

- Unpack the product and check if all of the contents listed below have been included.
- Store the packaging box in case you need to move the product at a later date.



Projector

CONTENTS



Quick Installation Guide



Warranty Card / Registration Card
(Not available in all locations)



User Manual



Power Cord



Remote Control / 1 Battery
(Not available in all locations)

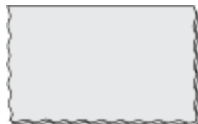

Cleaning Cloth



D-Sub Cable



Lens cover



4 Screws
(For bracket of ceiling mount.)



Projector case

- A ceiling mount is not included and must be purchased separately. Use the included crews to attach the projector to the ceiling mount bracket.

2-2 Installing the Projector

- Install the projector so that the beam from the projector is perpendicular to the screen.
 - Place the projector so that the lens aims at the center of the screen. If the screen is not vertical, the picture on the screen may not appear rectangular.
 - Do not install the screen in bright surroundings. If the surroundings are too bright, the picture on the screen will be washed out and not display clearly.
 - When using the projector in bright surroundings, use curtains to block the light.
 - You can install the projector in the following locations relative to the screen : <Front-Floor> / <Front-Ceiling> / <Rear-Floor> / <Rear-Ceiling>. To view the installation position settings, see below.

To adjust the picture when you install the projector behind the screen



Installing behind a semi-transparent screen.

When you install the projector behind a semi-transparent screen, you can use the menu to adjust the picture so that it displays correctly, depending on where you've located the projector, rear-floor (or low) or rear-ceiling.

1. For rear-floor, press :
Menu > Setup > Install > Rear-Floor
2. For rear-ceiling, press :
Menu > Setup > Install > Rear-Ceiling

To adjust the picture when you install the projector in the front of the screen

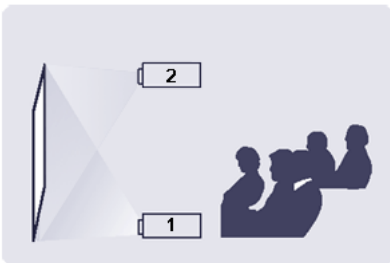

Installing the projector in front of the screen.

When you install the projector in front of a screen, you can use the menu to adjust the picture so that it displays correctly, depending on where you've located the projector, front-floor (or low) or front-ceiling.

1. For front-floor, press :
Menu > Setup > Install > Front-Floor
2. For front-ceiling, press :
Menu > Setup > Install > Front-Ceiling

2-3 Leveling with Adjustable Feet

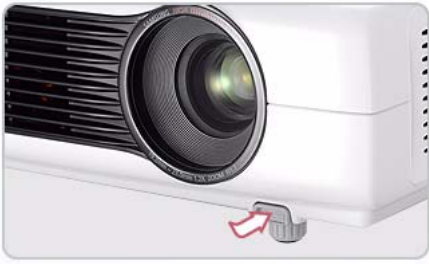

Press the PUSH buttons, as shown, to adjust the legs and level the projector.

- 🔧 The projector can be adjusted to a height of up to 30 mm (about 12 °) from the reference point.
If <Auto Keystone> is set to <On>, <V-Keystone> is adjusted automatically.
If fine tuning is required after auto-adjustment, use <V-Keystone>.

2-4 Zoom and Focus Adjustment



- 1** Zoom Knob You can adjust the size of the image within the zoom range by manipulating the Zoom Knob.
- 2** Focus Ring Focus the picture on the screen using the Focus Ring.

 The size of your screen determines the distance you set your projector from the screen.

If you do not install your projector at the projection distance specified in the Screen Size and Projection Distance table in Section 2-5, you will not be able to adjust the focus correctly.

2-5 Screen Size and Projection Distance

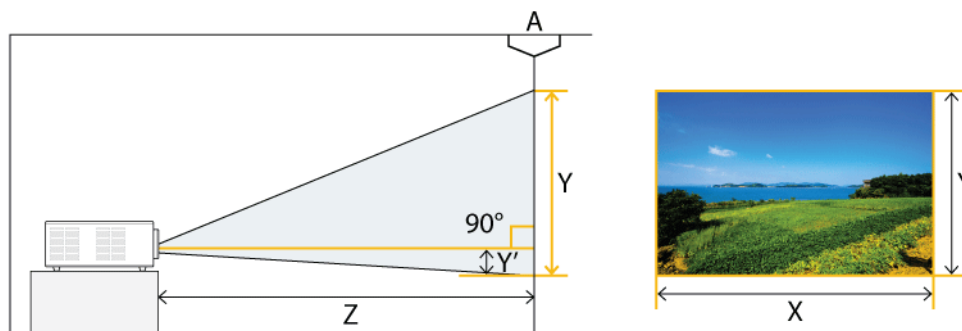

A. Screen / Z. Throw Distance / Y'. Distance from Lens Center to Image Bottom

Install the projector on a flat, even surface and level the projector using the adjustable feet to obtain optimal picture quality. If images are not clear, adjust them using the Zoom Knob or Focus Ring, or move the projector forward and backward.

SCREEN SIZE						THROW DISTANCE				OFFSET	
M (DIAGONAL)		X (HORIZONTAL)		Y (VERTICAL)		Z (TELE)		Z (WIDE)		Y'	
INCHES	CM	INCHES	CM	INCHES	CM	INCHES	CM	INCHES	CM	INCHES	CM
30	76.2	24	60.9	18	45.7	42.7	108.4	35.5	90.1	2.6	6.3
40	101.6	32	81.3	24	61.0	57.0	144.7	47.4	120.3	3.3	8.4
50	127.0	40	101.6	30	76.2	71.2	180.8	59.2	150.4	4.1	10.5
60	152.4	48	121.9	36	91.4	85.4	217.0	71.0	180.4	5.0	12.6
70	177.8	56	142.2	42	106.7	99.7	253.1	82.9	210.5	5.8	14.7
80	203.2	64	162.6	48	121.9	113.9	289.4	94.7	240.6	6.6	16.8
90	228.6	72	182.9	54	137.2	128.2	325.6	106.6	270.7	7.4	18.9
100	254.0	80	203.2	60	152.4	142.4	361.7	118.4	300.7	8.3	21.0
110	279.4	88	223.5	66	167.6	156.6	397.8	130.2	330.8	9.1	23.1
120	304.8	96	243.8	72	182.9	170.9	434.0	142.1	360.8	9.9	25.2
130	330.2	104	264.2	78	198.1	185.1	470.3	153.9	391.0	10.8	27.3
140	355.6	112	284.5	84	213.4	199.4	506.4	165.8	421.1	11.6	29.4
150	381.0	120	304.8	90	228.6	213.6	542.5	177.6	451.1	12.4	31.5
160	406.4	128	325.1	96	243.8	227.8	578.7	189.4	481.1	13.2	33.6
170	431.8	136	345.4	102	259.1	242.1	614.8	201.3	511.2	14.1	35.7
180	457.2	144	365.8	108	274.3	256.3	651.1	213.1	541.4	14.9	37.8
190	482.6	152	386.1	114	289.6	270.6	687.3	225.0	571.4	15.7	39.9
200	508.0	160	406.4	120	304.8	284.8	723.4	236.8	601.5	16.5	42.0
210	533.4	168	426.7	126	320.0	299.0	759.5	248.6	631.5	17.4	44.1
220	558.8	176	447.0	132	335.3	313.3	795.7	260.5	661.6	18.2	46.2
230	584.2	184	467.4	138	350.5	327.5	832.0	272.3	691.8	19.0	48.3
240	609.6	192	487.7	144	365.8	341.8	868.1	284.2	721.8	19.9	50.4
250	635.0	200	508.0	150	381.0	356.0	904.2	296.0	751.8	20.7	52.5

SCREEN SIZE						THROW DISTANCE				OFFSET	
M (DIAGONAL)		X (HORIZONTAL)		Y (VERTICAL)		Z (TELE)		Z (WIDE)		Y'	
INCHES	CM	INCHES	CM	INCHES	CM	INCHES	CM	INCHES	CM	INCHES	CM
260	660.4	208	528.3	156	396.2	370.2	940.4	307.8	781.9	21.5	54.6
270	685.8	216	548.6	162	411.5	384.5	976.5	319.7	811.9	22.3	56.7
280	711.2	224	569.0	168	426.7	398.7	1012.8	331.5	842.1	23.2	58.8
290	736.6	232	589.3	174	442.0	413.0	1049.0	343.4	872.2	24.0	60.9
300	762.0	240	609.6	180	457.2	427.2	1085.1	355.2	902.2	24.8	63.0
310	787.4	248	629.9	186	472.4	441.4	1121.2	367.0	932.3	25.6	65.1
320	812.8	256	650.2	192	487.6	455.7	1157.4	378.9	962.3	26.5	67.2
330	838.2	264	670.5	198	502.8	469.9	1193.5	390.7	992.3	27.3	69.3
340	863.6	272	690.8	204	518.0	484.2	1229.6	402.6	1022.4	28.1	71.4
350	889.0	280	711.1	210	533.2	498.4	1265.8	414.4	1052.4	29.0	73.5
360	914.4	288	731.4	216	548.4	512.6	1301.9	426.2	1082.5	29.8	75.6
370	939.8	296	751.7	222	563.6	526.9	1338.0	438.1	1112.5	30.6	77.7
380	965.2	304	772.0	228	578.8	541.1	1374.2	449.9	1142.6	31.4	79.8
390	990.6	312	792.3	234	594.0	555.4	1410.3	461.8	1172.6	32.3	81.9
400	1016.0	320	812.6	240	609.2	569.6	1446.4	473.6	1202.6	33.1	84.0

 This projector is designed to show images optimally on a 80 ~ 120 inch sized screen.

2-6 Lamp Replacement

Cautions on Lamp Replacement

- The projector lamp is an expendable item. For best operating performance, replace the lamp according to the usage time. You can view the lamp usage time in the Information Display (INFO button).
- Replace the lamp with the one specified below only.

Model	SP-M200, SP-M220	SP-M250, SP-M270, SP-M300
Lamp Model Name	DPL3311U	DPL3321U

- For inquiries on lamp purchase, please see 'Contact SAMSUNG WORLDWIDE' in section 5-3.

- Check that the power cord is unplugged before replacing the lamp.
- Because the lamp is a high temperature and high voltage product, wait at least one hour from the time you disconnect the power cord before replacing the lamp.
- The projector lamp is on the top of the projector.
- Do not leave the old lamp near flammable items or in reach of children. There is a danger of fire, burns, or injury.
- Remove dirt or foreign material around or inside the lamp unit using a proper vacuum device.
- When handling the lamp, avoid touching any part of it except for the handles. If you handle the lamp incorrectly, you can shorten the lamp's lifetime and affect picture quality.
- When you change the lamp, put the projector on a flat surface.
- The projector has been designed so that the projector does not work if the lamp cover is not completely assembled after a lamp replacement. If the projector does not work properly, please check the operating status of the indicator LED.

Lamp contains Mercury. Dispose According to Local, State or Federal Laws.

Lamp Replacement Procedure

- Because the lamp is a high temperature and high voltage product, wait at least one hour from the time that the power cord is disconnected before replacing it.
- The projector lamp is on the top of the projector.

1. Remove the screw shown in the figure below, and then open the cover.



(SP-M200, SP-M220, SP-M250)



(SP-M270, SP-M300)

2. With the cover open, remove the three (3) screws on the top of the projector as shown in the figure below.



3. To remove the lamp, hold and then pull the lamp handle as shown in the figure below.



- 🔧 Install a new lamp in the reverse order of removal.

Replacing and Cleaning the Filter

Precautions when replacing the projector filter:

- The filter is on the side of the projector.
- Turn off the power of the projector, and then disconnect the power cord after the projector has cooled sufficiently. Otherwise, its parts may be damaged due to internal heat.
- When you replace the filter, you may release some dust.
- For inquiries on replacement filter purchase, please see 'Contact SAMSUNG WORLDWIDE' in Chapter 5.

To replace or clean the filter, follow these steps:

1. Turn off the power of the projector, and then disconnect the power cord after the projector has cooled sufficiently.
2. Open the filter cover.



3. Replace or clean the filter.

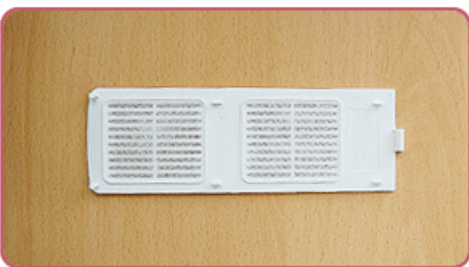

- When cleaning the filter, use a small vacuum cleaner designed for computers and small electronics products, or wash it under running water.
- After washing the filter under running water, make sure to dry it completely. The moisture may cause the filter to corrode.
- If dust cannot be separated from the filter or the filter is torn, it must be replaced.
- After cleaning or replacing the filter, run <Reset> -> <Reset Filter Time> in the <Setup> menu.

Ventilation openings

For the location of the ventilation openings, see the picture below:

- Do not block the ventilation openings. Blocking the ventilation openings can cause your projector to overheat and may cause it to fail.



1 Air outtake vent

2 Air intake vent

2-7 Rear Side

2-7-1. SP-M200 / SP-M220 / SP-M250

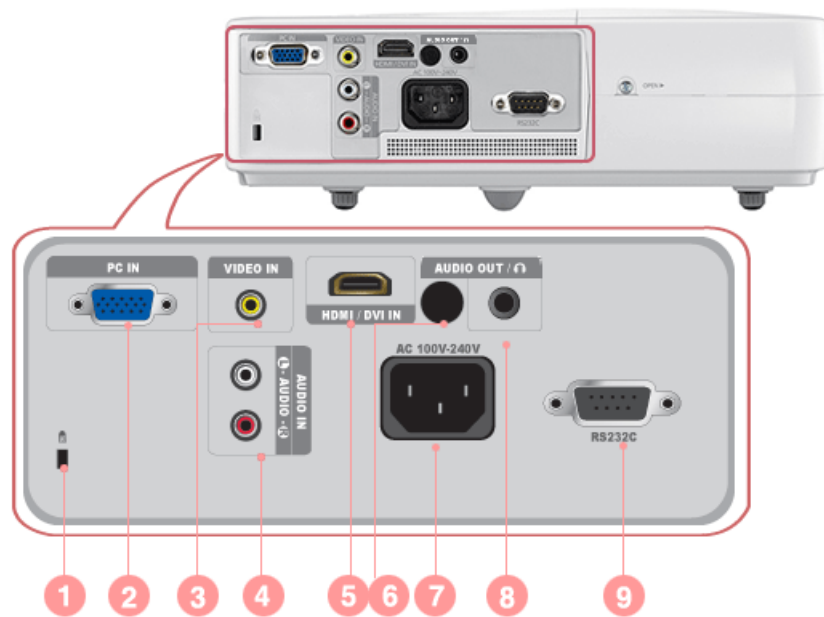

ICON	NAME
1	Kensington Lock slot
2	PC IN port
3	VIDEO IN port
4	AUDIO IN (L-AUDIO-R) port
5	HDMI/DVI IN port
6	Remote Control Signal Receiver
7	Power Input port
8	AUDIO OUT/ speaker port
9	RS232C port

2-7-2. SP-M270 / SP-M300

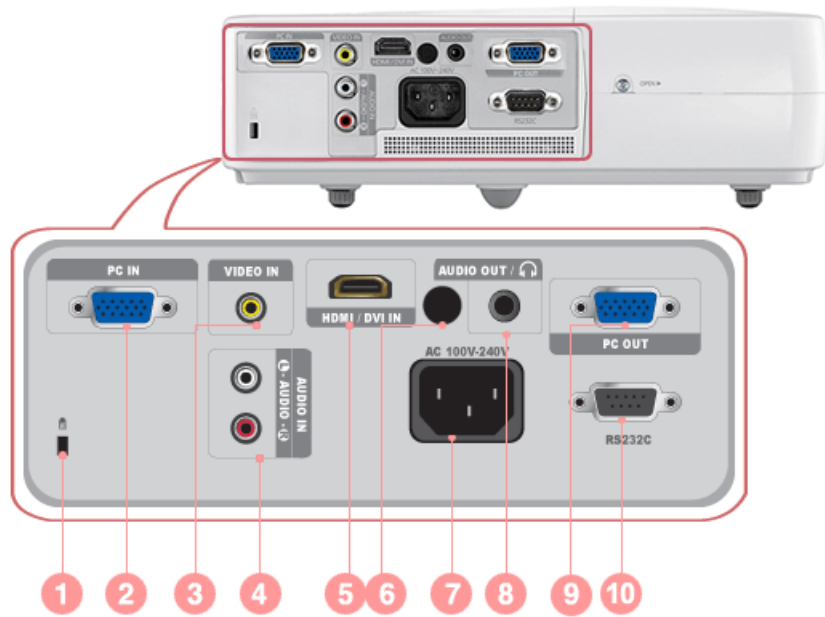

ICON	NAME
1	Kensington Lock slot
2	PC IN port
3	VIDEO IN port
4	AUDIO IN (L-AUDIO-R) port
5	HDMI/DVI IN port
6	Remote Control Signal Receiver
7	Power Input port
8	AUDIO OUT/ speaker port
9	PC OUT port
10	RS232C port

2-8 Supported Display Modes

2-8-1. PC Timing (D-Sub/HDMI)

FORMAT	RESOLUTION		HORIZONTAL FREQUENCY (KHZ)	VERTICAL FREQUENCY (HZ)	PIXEL FREQUENCY (MHZ)
IBM	640 x 350	70Hz	31.469	70.086	25.175
IBM	640 x 480	60Hz	31.469	59.940	25.175
IBM	720 x 400	70Hz	31.469	70.087	28.322
VESA	640 x 480	60Hz	31.469	59.940	25.175
MAC	640 x 480	67Hz	35.000	66.667	30.240
VESA	640 x 480	70Hz	35.000	70.000	28.560
VESA	640 x 480	72Hz	37.861	72.809	31.500
VESA	640 x 480	75Hz	37.500	75.000	31.500
VESA	720 x 576	60Hz	35.910	59.950	32.750
VESA	800 x 600	56Hz	35.156	56.250	36.000
VESA	800 x 600	60Hz	37.879	60.317	40.000
VESA	800 x 600	70Hz	43.750	70.000	45.500
VESA	800 x 600	72Hz	48.077	72.188	50.000
VESA	800 x 600	75Hz	46.875	75.000	49.500
MAC	832 x 624	75Hz	49.726	74.551	57.284
VESA	1024 x 768	60Hz	48.363	60.004	65.000
VESA	1024 x 768	70Hz	56.476	70.069	75.000
VESA	1024 x 768	72Hz	57.672	72.000	78.434
VESA	1024 x 768	75Hz	60.023	75.029	78.750
VESA	1152 x 864	60Hz	53.783	59.959	81.750
VESA	1152 x 864	70Hz	63.000	70.000	96.768
VESA	1152 x 864	72Hz	64.872	72.000	99.643
VESA	1152 x 864	75Hz	67.500	75.000	108.000
VESA	1280 x 720	60Hz	44.772	59.855	74.500
VESA	1280 x 720	70Hz	52.500	70.000	89.040
VESA	1280 x 720	72Hz	54.072	72.000	91.706
VESA	1280 x 720	75Hz	56.456	74.777	95.750
VESA	1280 x 768	60Hz	47.776	59.870	79.500
VESA	1280 x 768	75Hz	60.289	74.893	102.250
VESA	1280 x 800	60Hz	49.702	59.810	83.500
VESA	1280 x 800	75Hz	62.795	74.934	106.500
VESA	1280 x 960	60Hz	60.000	60.000	108.000
VESA	1280 x 960	70Hz	69.930	70.000	120.839

FORMAT	RESOLUTION		HORIZONTAL FREQUENCY (KHZ)	VERTICAL FREQUENCY (HZ)	PIXEL FREQUENCY (MHZ)
VESA	1280 x 960	72Hz	72.072	72.000	124.540
VESA	1280 x 960	75Hz	75.231	74.857	130.000
VESA	1280 x 1024	60Hz	63.981	60.020	108.000
VESA	1280 x 1024	70Hz	74.620	70.000	128.943
VESA	1280 x 1024	72Hz	76.824	72.000	132.752
VESA	1280 x 1024	75Hz	79.976	75.025	135.000
VESA	1400 x 1050	60Hz	65.317	59.978	121.750
VESA	1440 x 900	60Hz	55.935	59.887	106.500
VESA	1440 x 900	75Hz	70.635	74.984	136.750
VESA	1600 x 1200	60Hz	75.000	60.000	162.000

 All resolutions higher or lower than 1024x768 are converted to 1024x768 by the Scaler chip inside the projector. If the resolution of the signal out put by the PC matches the real resolution (1024x768) of the projector, the screen quality is optimal.

2-8-2. AV Timing (D-Sub)

FORMAT	RESOLUTION		SCAN
BT.601 SMPTE 267M	480i	59.94Hz	Interlaced
BT.1358 SMPTE 293M	480p	59.94Hz	Progressive
BT.601	576i	50Hz	Interlaced
BT.1358	576p	50Hz	Progressive
SMPTE 296M	720p	59.94Hz/60Hz	Progressive
	720p	50Hz	Progressive
BT.709 SMPTE 274M	1080i	59.94Hz/60Hz	Interlaced
	1080i	50Hz	Interlaced

2-8-3. AV Timing (HDMI)

FORMAT	RESOLUTION	SCAN	HORIZONTAL FREQUENCY (KHZ)	VERTICAL FREQUENCY (HZ)	PIXEL FREQUENCY (MHZ)	
EIA-861	Format1	640 x 480	Progressive	59.940	31.469	25.175
EIA-861	Format1	640 x 480	Progressive	60.000	31.500	25.200
EIA-861	Format2,3	720 x 480	Progressive	59.940	31.469	27.000
EIA-861	Format2,3	720 x 480	Progressive	60.000	31.500	27.027
EIA-861	Format4	1280 x 720	Progressive	59.939	44.955	74.175
EIA-861	Format4	1280 x 720	Progressive	60.000	45.000	74.250
EIA-861	Format5	1920 x 1080	Interlaced	59.939	33.716	74.175

FORMAT		RESOLUTION	SCAN	HORIZONTAL FREQUENCY (KHZ)	VERTICAL FREQUENCY (HZ)	PIXEL FREQUENCY (MHZ)
EIA-861	Format5	1920 x 1080	Interlaced	60.000	33.750	74.250
EIA-861	Format17,18	720 x 576	Progressive	50.000	31.250	27.000
EIA-861	Format19	1280 x 720	Progressive	50.000	37.500	74.250
EIA-861	Format20	1920 x 1080	Interlaced	50.000	28.125	74.250

2-8-4. AV Timing (VIDEO)

NTSC, NTSC 4.43, PAL, PAL60, PAL-N, PAL-M, SECAM

Your projector supports the standard video formats listed above through its video inputs. No adjustments are necessary.

2-9 Connecting the Power

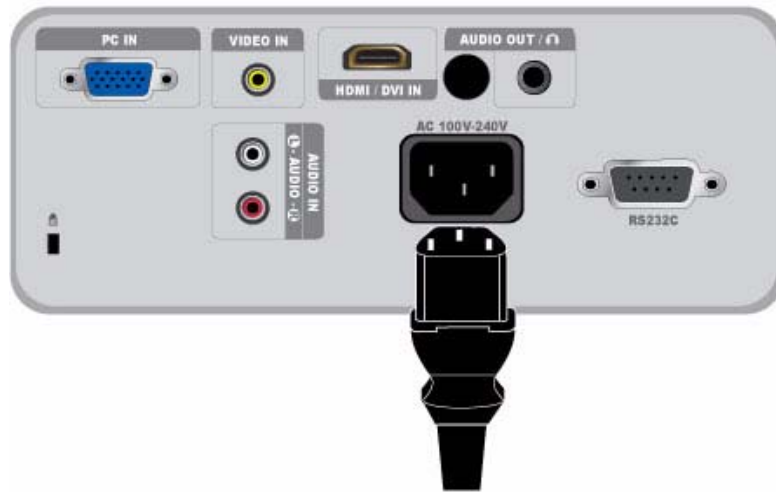

1. Plug the power cord into the power terminal on the rear side of the projector.

2-10 Connecting with a PC and Setting up the PC

2-10-1. Setting up the PC Environment

Check the following items before connecting your PC to your projector.

1. Click the right mouse button on the Windows desktop, and then click [Properties].
The <Display Properties> dialog appears.



2. Click the [Settings] tab, and then set the <Screen resolution>. The optimal resolution for the projector is 1024 x 768. For other resolutions supported by the projector, see the PC Timing Display Mode table in section 2-8.

 You do not have to change the <Color quality> setup.

3. Press the [Advanced] button. Another property window appears.

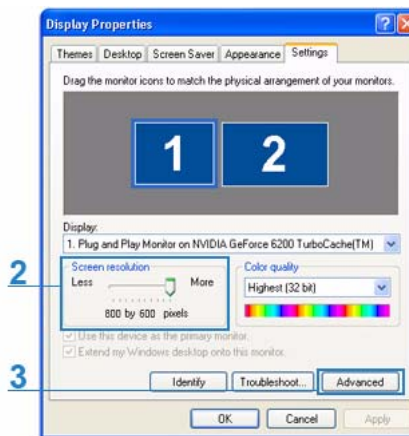

4. Click the [Monitor] tab and set the <Screen refresh rate>. For the refresh rate that matches the resolution you've chosen, see the refresh rate (60 Hz, 70 Hz, etc.) next to your selected resolution in the PC Timing Display Mode table in section 2-8.

- Setting the refresh rate sets both the vertical and horizontal frequencies.

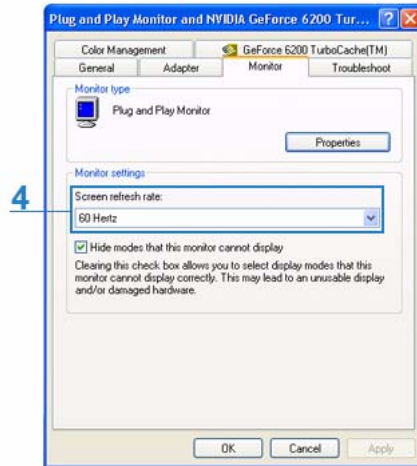

- Click the [OK] button to close the window, and then click the [OK] button on the <Display Properties> window to close that window.
- Shut down the PC and connect it to the projector.

- The setup process might vary depending on your type of computer or version of Windows.

(For example, [Properties] appears instead of [Properties (R)] as shown in 1.)

This projector supports 32 bit color quality (per pixel) when it is used as a PC monitor.

Projected images may differ from the images on your monitor depending on the monitor manufacturer or Windows version.

When connecting the projector to a PC, make sure that the PC setup complies with the display settings supported by this projector. If it does not, you may have signal problems.

2-10-2. Connecting with a PC

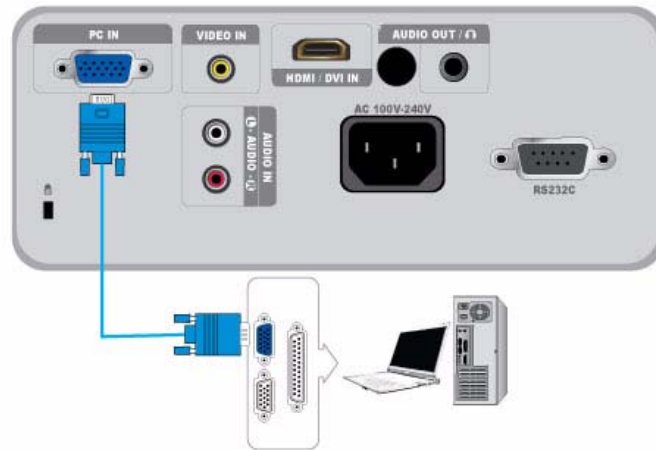

Make sure that your PC and projector are turned off.

1. Connect the [PC IN] port on the rear side of the projector to the PC video out (D-sub) port of the PC using a PC video cable.
2. Plug in the power cords of the projector and the PC.

 This product supports plug and play. If you use Windows XP, you do not need to set up the driver on your PC.

Using the Projector

1. Turn on the projector, and then press the [SOURCE] button to select <PC>. If the <PC> Mode is not available, make sure the PC video cable is properly connected.
2. Turn on the PC, and then set the PC Environment (screen resolution, etc.) if necessary.
3. Adjust the screen.

2-10-3. Connecting Video Devices (Monitor, TV, etc.) (SP-M270, SP-M300 Models Only)

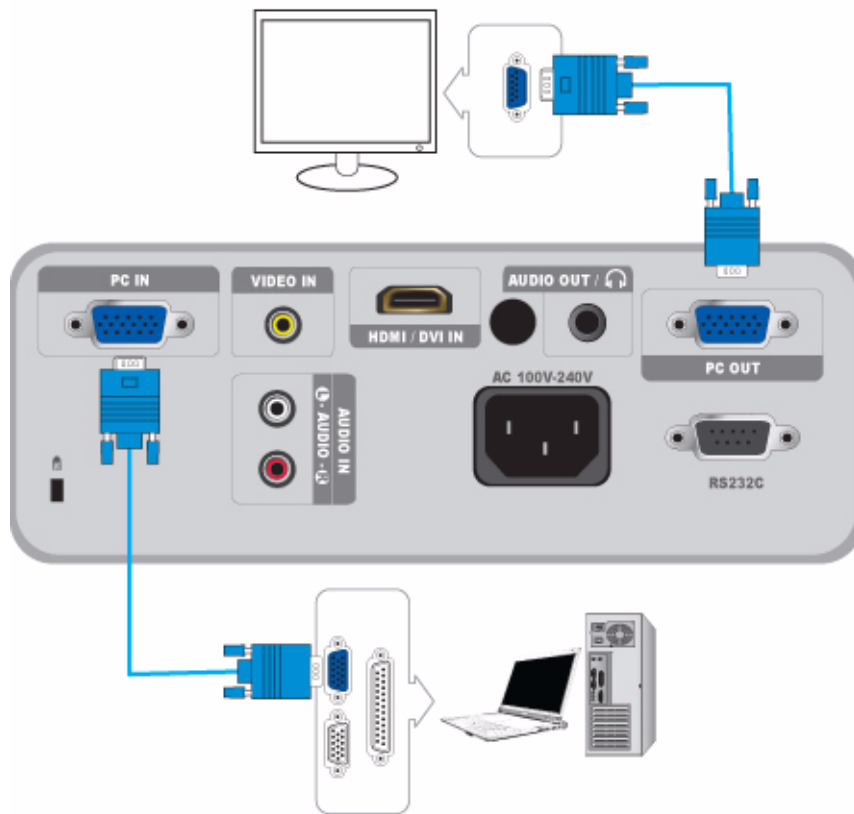

You can view an image on both your projector and a separate monitor at the same time.

Make sure that your PC and projector are turned off.

1. Connect the [PC IN] terminal at the back of the projector to the D-Sub (PC, VGA) terminal of your PC using a D-Sub cable.
2. Connect the [PC OUT] terminal of the projector to the D-Sub terminal of a monitor using a D-Sub cable.
 - When connecting a monitor using the [PC OUT] function, make sure to connect your PC to the [PC IN] terminal.
 - The video on the monitor connected to the [PC OUT] terminal will be normal even if your projector displays a blank screen.
 - The [PC OUT] function will not operate in standby mode.

2-11 Connecting a PC using an HDMI/DVI cable

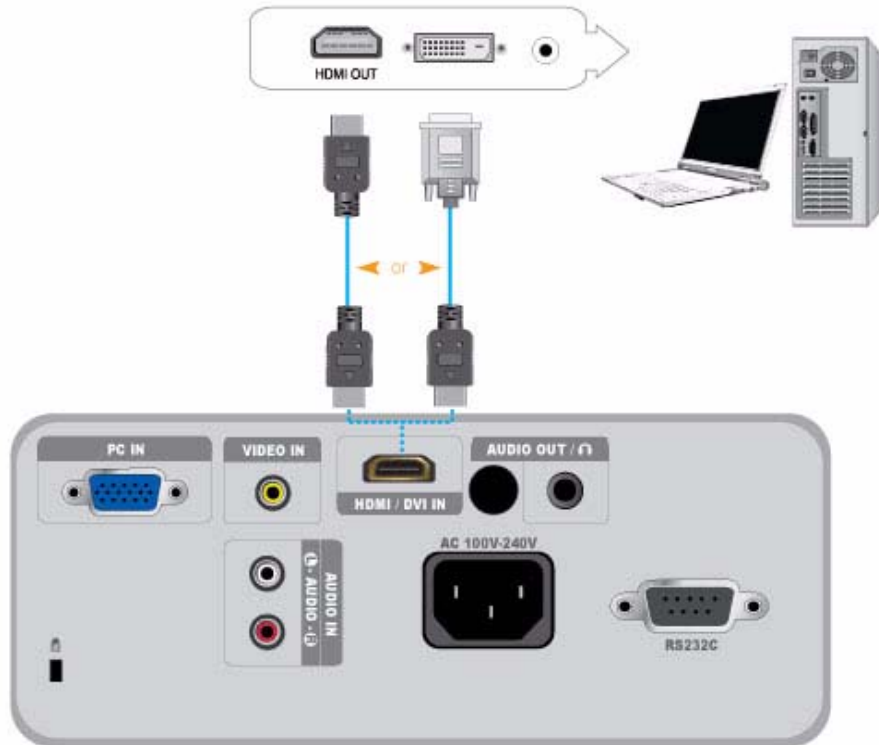

Make sure that your PC and projector are turned off.

1. Connect the [HDMI/DVI IN] terminal of the projector to the HDMI or DVI terminal of your PC using a HDMI/HDMI or HDMI/DVI cable (Not supplied).
 - If you are connecting to the HDMI terminal of your PC, use an HDMI/HDMI cable (Not supplied).
 - For the supported resolutions and refresh rates, see PC Timing (D-Sub/HDMI) in Section 2-8, "Supported Display Modes".

2-12 Connecting an HDMI-Compatible Device

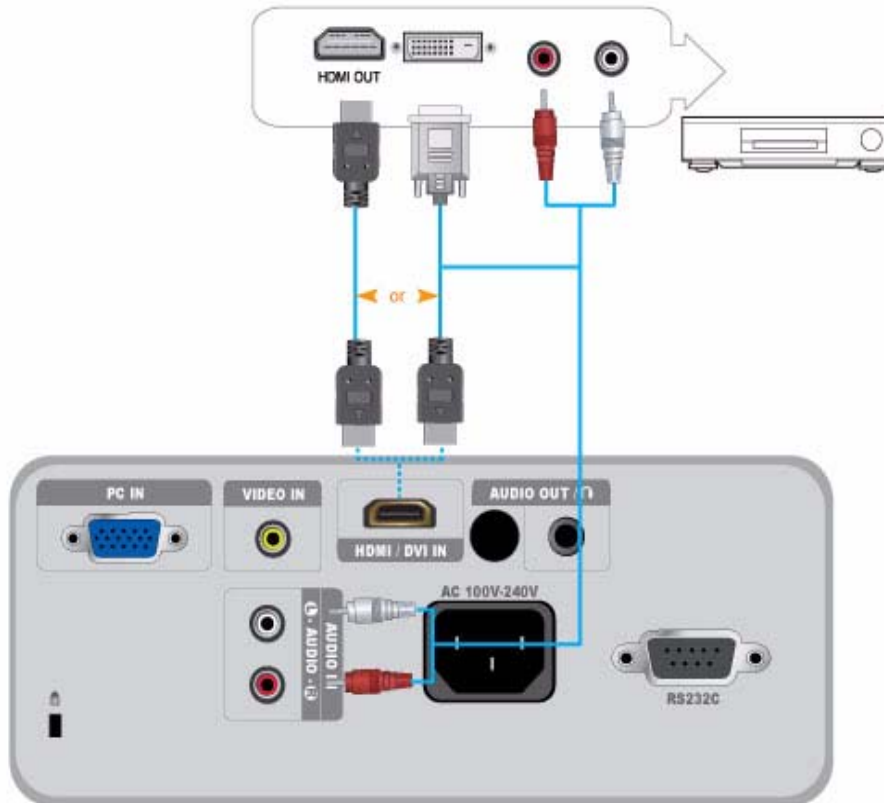

Make sure that the AV device and your projector are turned off.

1. Connect the [HDMI/DVI IN] terminal at the back of the projector to the HDMI or HDMI/DVI output terminal of the digital output device using an HDMI/DVI or HDMI/HDMI cable.
 - If you are connecting to the HDMI output terminal on the digital output device, use an HDMI/HDMI cable.
 - For supported input signal formats, resolutions, and frequencies, see AV Timing (HDMI) in Section 2-8, "Supported Display Modes".
2. If you connected using a HDMI/DVI cable, connect the [AUDIO IN (L-AUDIO-R)] terminal on the projector to the Audio out terminal on your digital output device using an audio cable (Not supplied).
 - If you connected with a HDMI/HDMI cable, you do not need an audio cable.

2-13 Connecting an AV device using a D-Sub cable

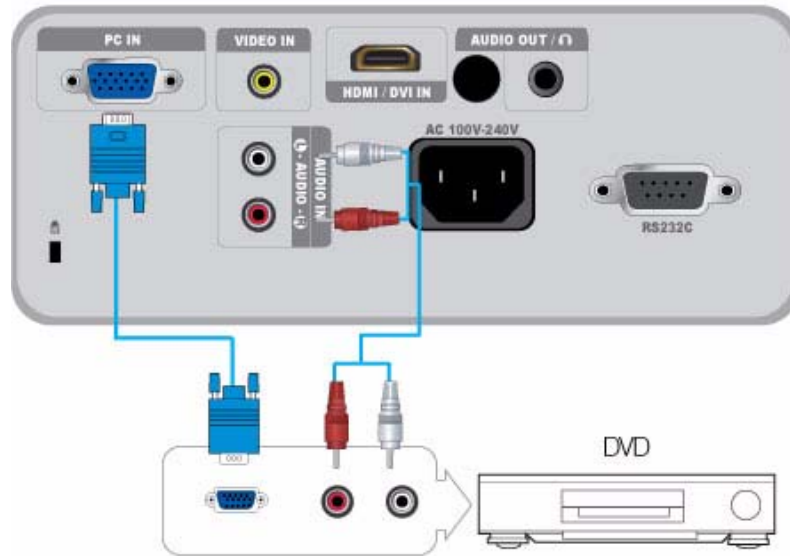

Make sure that the AV device and your projector are turned off.

1. Connect the [PC IN] terminal at the back of the projector to the D-Sub terminal of your AV device using a D-Sub cable.
- For supported input signal formats, resolutions, and frequencies, see AV Timing (D-Sub) in Section 2-8, "Supported Display Modes".
2. Connect the [AUDIO IN (L-AUDIO-R)] terminal at the back of the projector to the Audio out terminal of your AV device using an audio cable (Not supplied).

2-14 Connecting an AV device with Component output

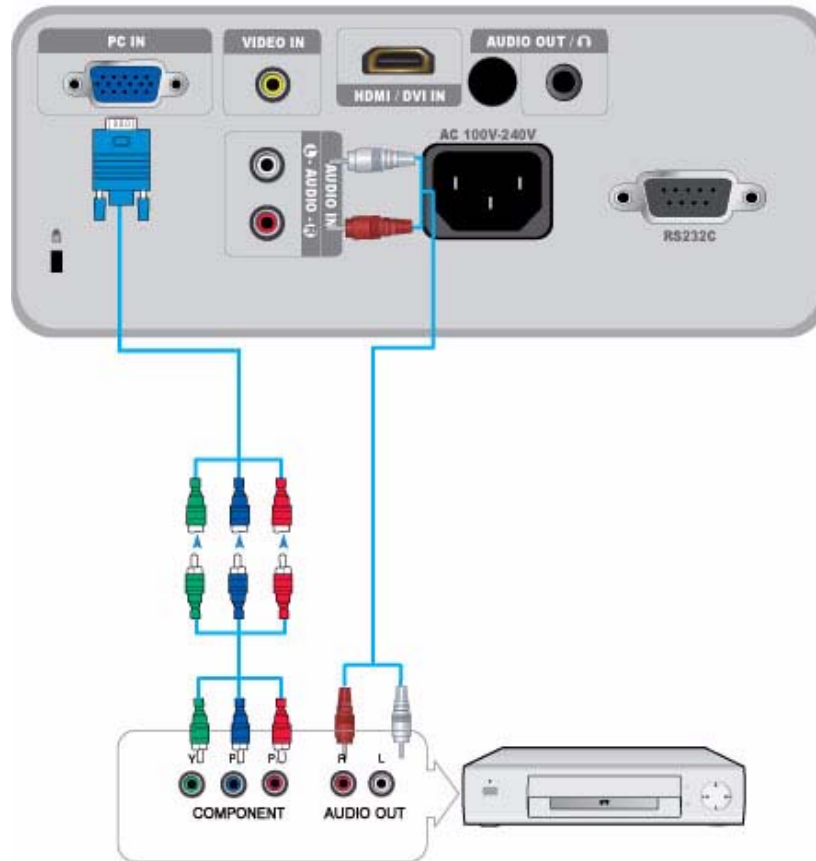

Make sure that the AV device and your projector are turned off.

1. Connect the [PC IN] terminal on the back of the projector to the Component terminal on your AV device using a D-Sub to Component cable (Not supplied). This cable has a D-Sub connector on one end and three RCA jacks on the other.
- For supported input signal formats, resolutions, and frequencies, see AV Timing (D-Sub) in Section 2-8, "Supported Display Modes".
2. Connect the [AUDIO IN (L-AUDIO-R)] terminal on the back of the projector and the Audio out terminal on your AV device using an audio cable (Not supplied).

2-15 Connecting using a Video cable

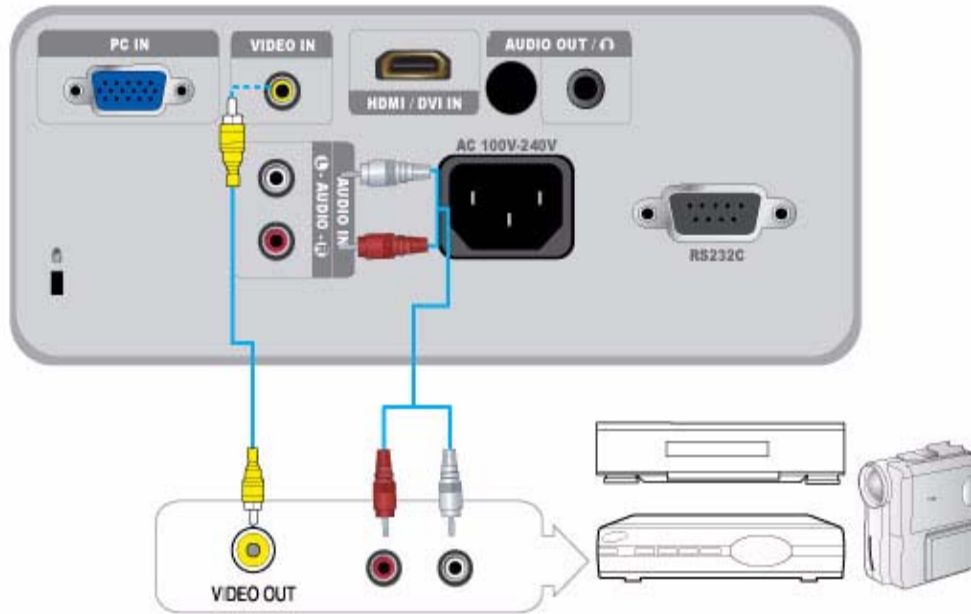

Make sure that the AV device and your projector are turned off.

1. Connect the AV device to the [VIDEO] port using a VIDEO cable (not supplied).
- For supported input signal formats, see AV Timing (VIDEO) in section 2-8, "Supported Display Modes".
2. Connect the [AUDIO IN (L-AUDIO-R)] terminal on the back of the projector and the Audio out terminal on your AV device using an audio cable (Not supplied).

2-16 Connecting an External Speaker

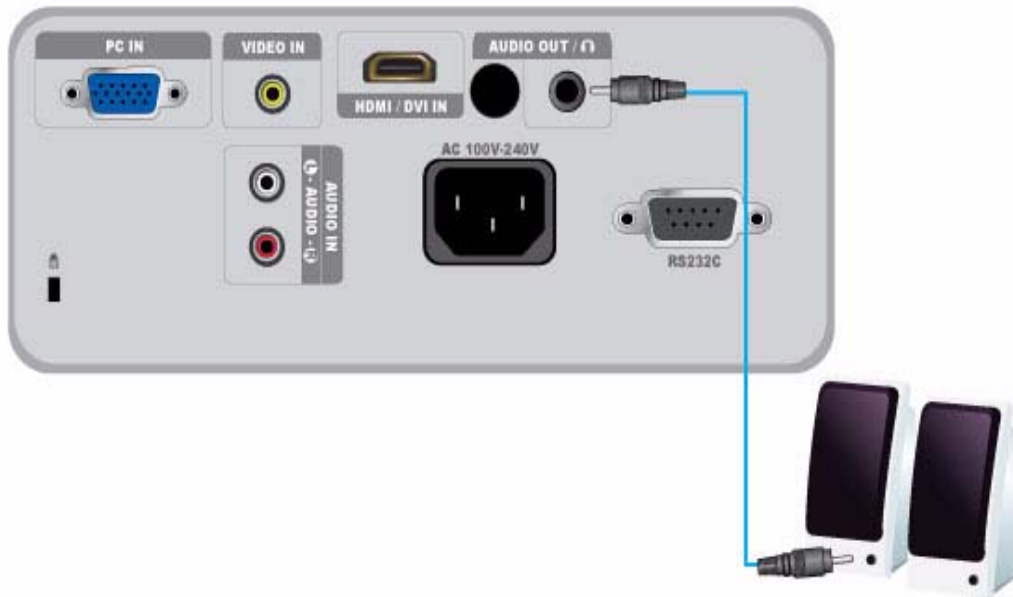

You can hear sound through an external speaker instead of the internal speakers built into the projector.

1. Obtain an audio cable (Not supplied) suitable for your external speaker.
2. Connect the [AUDIO OUT/[speaker icon]] terminal of the projector to the external speaker using an audio cable.
 - When using an external speaker, the internal speaker does not operate, but you can adjust the volume of the external speaker using the Volume button or the remote control of the projector.
 - The [AUDIO OUT/[speaker icon]] terminal can output all audio signals.

2-17 Kensington Lock slot

The Kensington Lock slot allows you to lock your projector, providing a sense of security when you use it in a public place. Because the shape and usage of the lock may differ depending on the model and the manufacturer, see the User Manual supplied with the locking device for more information.

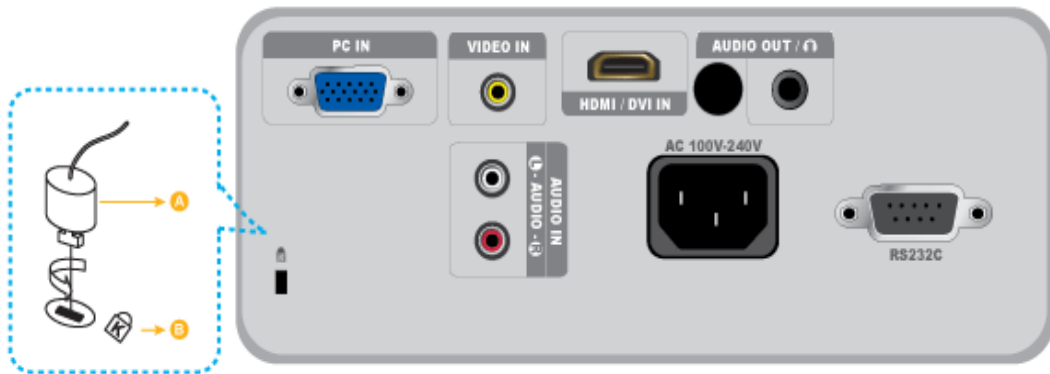

Locking the product

1. Loop the Kensington lock cable around an immovable part of desk or heavy object as directed in the Kensington lock user manual.
2. Insert the locking part of the locking device into the Kensington lock hole in the projector.
3. Insert the Kensington lock key into the locking mechanism and turn it in the locking direction.

 You can purchase a locking device from an electronics store or an online shop.

3 Using

3-1 Product Features

1. An optical engine adopting new LCD technology
 - 1024 x 768 resolution.
 - 3P-LCD panel.
 - SP-M200 : Provides a bright, 2000 lumen screen.
 - SP-M220 : Provides a bright, 2200 lumen screen.
 - SP-M250 : Provides a bright, 2500 lumen screen.
 - SP-M270 : Provides a bright, 2700 lumen screen.
 - SP-M300 : Provides a bright, 3000 lumen screen.
2. Minimized fan noise
 - Minimizes fan noise through optimized internal air flow and the fan installation structure.
3. Multiple input terminals
 - Increases the connectivity to peripheral devices such as D-Sub 15P (supporting DTV signal), Video, HDMI, PC OUT, etc. (The PC OUT function is only be supported by the SP-M270 and SP-M300 models.)
4. Audio Output
 - Equipped with an internal 7W (mono) speaker.
5. User adjustments
 - Allows adjustment of each input port.
 - Equipped with an internal Test Pattern that can be used to install and adjust the projector.
 - Compact size, lightweight, and portable.

3-2 Front, Upper



ICON	NAME	DESCRIPTION
1	Indicators	<ul style="list-style-type: none"> - STAND BY (Blue LED) - LAMP (Blue LED) - STATUS (Green/Red/Yellow LED) <p> Refer to the LED Indications.</p>
2	Move $\wedge \vee \langle \rangle$ / Select / Volume $\langle \rangle$ button	$\wedge \vee \langle \rangle$ / : Use to move or to select an item within a menu. $\langle \rangle$: Use to adjust the volume.
3	MENU button	Use to display the Menu Screen.
4	SOURCE button	Use to select the external device signal.
5	POWER button	Use to turn the projector on or off.
6	Zoom Knob	Use to enlarge or reduce image size.
7	Focus Ring	Use for Focus Adjustment.
8	Lens	
9	Remote Control Signal Receiver	
10	Hole for attaching lens cap string	

3-3 Remote Control

- Using your projector with another remote control device nearby may result in improper functioning due to remote control code (frequency) interference.

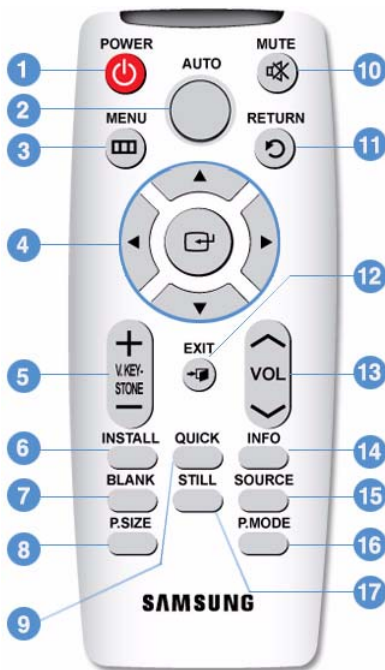

- POWER (⏻) Button**
Use this button for turning the product on and off.
- AUTO Button**
Adjusts the Picture automatically. (Available in <PC> Mode Only)
- MENU (≡) Button**
Use to display the Menu Screen.
- Move (↶↷↸↹) / (⏪) Buttons**
Use to move to or select each menu item.
- V. KEYSTONE (+/-) Button**
Use when the screen is displayed in a trapezoid shape.
- INSTALL Button**
Use to adjust the image so that it is appropriate for the projector's installation location (In front of the screen and hanging from the ceiling, behind the screen and hanging from the ceiling, etc.)
- BLANK Button**
Use to turn off the screen and sound temporarily. The video and audio will come back on when you press any button other than the [POWER] button.
- P.SIZE Button**
Use to adjust the size of picture screen.
- QUICK Button**
Use to return to the last menu used quickly.
- MUTE (🔇) Button**
Press to mute the sound temporarily. Press the MUTE button again or the VOL button (⏮) when the sound is muted to hear sound again.
- RETURN (↶) Button**
Returns to the previous menu.
- EXIT (✖) Button**
Use to make the Menu Screen disappear.
- VOL (⏮) Button**
Use to control the volume.
- INFO Button**
Use to check source signals, picture setup, PC screen adjustment, and lamp lifespan.
- SOURCE Button**
Use to check or select the connection status of external devices.
- P.MODE Button**
Use to select Picture Mode.
- STILL Button**
Use to see still images.

- Make sure to place your remote control on a table or desk. If you step on the remote control, you may fall and hurt yourself or damage the remote.
- You can use the remote control up to a distance of about 32.8 feet (10 m) from the product.

3-4 LED Indications

LED Indications

●:Light is On ●:Light is Blinking ○:Light is Off

STATUS	LAMP	STAND BY	STATUS
○	○	●	If you press the [POWER] button on the remote control or projector, the screen appears within 30 seconds.
○	●	●	The projector is operating normally.
○	●	●	The projector is preparing an operation after the [POWER] button on the projector or the remote control has been pressed.
○	●	○	The [POWER] button has been pressed to turn off the projector, and the cooling system is in operation to cool off the inside of the projector. (Operates for about 3 seconds.)
●	○	●	The cooling fan inside the projector is not operating normally. Refer to Action 1 in Clearing Indicator Problems below.
●	○	●	The lamp cover protecting the lamp unit is not closed properly. Refer to Action 2 in Clearing Indicator Problems below.
●	○	●	The projector has changed to Cooling mode because its internal temperature has increased beyond the maintenance limit. Refer to Action 4 in Clearing Indicator Problems below.
●	○	●	The projector has turned itself off automatically because its internal temperature has increased beyond the maintenance limit. Refer to Action 5 in Clearing Indicator Problems below.
●	●	●	A problem has occurred with the operation of the lamp. Refer to Action 6 below.

Clearing Indicator Problems

CLASSIFICATION	STATE	MEASURES
Action 1	The cooling fan system is not operating normally.	If the symptom remains even after disconnecting and then reconnecting the power cord and turning the projector on again, contact your product provider or our service center.
Action 2	The lamp cover protecting the lamp unit is not properly closed or the sensor system is not operating normally.	Check if the screws on the side of the projector are securely tightened. If they are and the indicators are still lit, contact your product distributor or a service center.
Action 3	The lens cover has not opened completely.	Open the lens cover completely.
Action 4	The projector has changed to the Cooling mode because the internal temperature of the projector has increased beyond the maintenance limit.	<p>If the internal temperature of the projector has increased beyond the maintenance limit, the projector changes to the Cooling mode before turning off automatically.</p> <p>* In Cooling mode, the fan speed is increased and the projector's lamp is changed to <ECO> mode.</p> <p>Check whether the ventilation hole of the projector is blocked.</p> <p>Check the air filter and clean if blocked.</p> <p>Check whether the surrounding temperature of the projector is higher than the standard temperature range of the projector.</p> <p>Cool the projector sufficiently and operate it again.</p>
Action 5	The internal temperature of the projector has risen higher than the limit, and the projector has turned off automatically.	<p>Check whether the ventilation hole of the projector is blocked.</p> <p>Check the air filter and clean if blocked.</p> <p>Check whether the surrounding temperature of the projector is higher than the standard temperature range of the projector.</p> <p>Cool the projector sufficiently and operate it again.</p> <p>If the same problem occurs continually, contact your product distributor or service center.</p>
Action 6	The lamp has malfunctioned after power turns off abnormally or after the projector is powered on right after turning off.	Turn the power off, wait for a sufficient amount of cooling time and then turn the power on to operate. If the same problem occurs continually, contact a Samsung service center.

 This Projector uses a cooling fan system to keep the unit from overheating. Operation of the cooling fan may produce noise, This does not affect product performance and is part of normal operation.

3-5 Using the Screen Adjustment Menu (OSD: On Screen Display)

The Screen Adjustment Menu (OSD: On Screen Display) Structure

To access the Menu, press the Menu button on the product or on the remote. To move in the menu, press the arrow buttons. Menu selections with an arrow on the far right have sub-menus. Press the right arrow button to access the sub-menu. Directions for navigating and selecting items in a menu are at the bottom of each menu screen.

MENU	SUB-MENU				
Input	Source List	Edit Name			
Picture	Mode	Size	Position	Digital NR	Black Level
	Overscan	Film Mode	PC	Zoom	
Setup	Install	Lamp Mode	Auto Keystone	V-Keystone	Background
	Test Pattern	Video Type	Caption	Reset	
Option	Language	Menu Option	Sound	Filter Check Time	Auto Power On
	Sleep Timer	Melody	Security	Panel Lock	Information

3-5-1. Input









MENU	DESCRIPTION
Source List	You can select a device connected to the projector to display. <ul style="list-style-type: none"> <PC>-<AV>-<HDMI>
Edit Name	You can edit the names of devices connected to the projector. <ul style="list-style-type: none"> <VCR>-<DVD>-<Cable STB>-<Satellite STB>-<PVR STB>-<AV Receiver>-<Game>-<Camcorder>-<PC>-<DVI Devices>-<TV>-<IPTV>-<Blu-ray>-<HD DVD>-<DMA>

3-5-2. Picture





MENU	DESCRIPTION
Mode	<p>Select a screen mode to match the environment, the kind of images you are projecting, or select a customized mode you have created based on your requirements.</p> <ul style="list-style-type: none"> • <Mode> <ul style="list-style-type: none"> • <Dynamic> : Selects the picture for increased definition in a bright room. • <Standard> : Selects the picture for the optimum display in a normal environment. • <Presentation> : This mode is suitable for presentations. • <Text> : This mode is suitable for text work. • <Movie> : This mode is suitable for viewing a movie. • <Game> : This picture mode is optimized for playing games. <ul style="list-style-type: none"> 🔒 In <Game> mode, the text in still pictures may appear unnatural. • <User> : This is a customized mode you create using the <Mode>→<Save> function. <ul style="list-style-type: none"> 🔒 <Presentation> and <Text> modes are only enabled if the input signal is a PC Timing (D-Sub/HDMI) signal. • <Contrast> : Used to adjust the contrast between the object and the background. • <Brightness> : Used to adjust the brightness of the entire picture. • <Sharpness> : Used to adjust the sharpness of the picture. <ul style="list-style-type: none"> 🔒 When the input signal is a PC Timing (D-Sub/HDMI) signal, the <Sharpness> cannot be adjusted. • <Color> : Used to adjust color lighter or darker. <ul style="list-style-type: none"> 🔒 When the input signal is a PC Timing (D-Sub/HDMI) signal, the <Color> cannot be adjusted. • <Tint> : Used to obtain more natural color by enhancing the amount of green or red in images. <ul style="list-style-type: none"> 🔒 When the input signal is a PC Timing (D-Sub/HDMI) signal or PAL and SECAM signal in the [AV] modes, the <Tint> cannot be adjusted. • <Color Tone> : The tone of the color can be changed. <ul style="list-style-type: none"> • Factory defaults: <COOL2>, <COOL1>, <WARM1>, <WARM2> • You can select the color temperature for the items below according to your preferences. <ul style="list-style-type: none"> <R-Gain>, <G-Gain>, <B-Gain> : Adjusts the color temperature of the White level. <R-Offset>, <G-Offset>, <B-Offset> : Adjusts the color temperature of the Black level. • <Color Tone>-<R-Gain>-<G-Gain>-<B-Gain>-<R-Offset>-<G-Offset>-<B-Offset> • <Gamma> : Changes the brightness characteristic for each color tone of an image. <ul style="list-style-type: none"> • The larger (+) the value, the greater the contrast of the bright and dark parts. • The smaller (-) the value, the darker the dark parts. • Adjustable range: -3 to +3 • <Save> : You can save the status of a screen you adjusted according to your preferences using the <Mode>→<User> OSD. • <Reset> : Restores the mode settings to the factory defaults.
Size	<p>Using this function, you select a screen size.</p> <ul style="list-style-type: none"> 🔒 When the input signal is a PC Timing (D-Sub/HDMI) signal, <Zoom1>/<Zoom2> is not supported. • <Normal>-<Zoom1>-<Zoom2>-<16 : 9>

MENU	DESCRIPTION
Position	<p>Using this function, you can adjust the screen position if it is not aligned.</p> <p>To adjust, select the direction you want to move the screen, and then press the arrow button pointing in that direction repeatedly.</p>
Digital NR	<p>If dotted lines appear in an image or the screen shakes, enabling Digital NR (Noise Reduction) can improve the quality of the picture.</p> <p> When the input signal is a PC Timing (D-Sub/HDMI) signal, <Digital NR> does not operate.</p>
Black Level	<p>If the black level is unsuitable for the input signal, the dark parts of an image may look unclear or dim. Using this function, you can select a black level that can improve the visibility of the dark parts.</p> <p> The <Black level> can only be set for the 480i and 576i RGB signals in the [AV], and AV Timing (D-Sub) modes.</p> <p>For [AV], and the 480i and 576i signals of AV Timing (D-Sub).</p> <ul style="list-style-type: none"> • <0 IRE> : Sets the black level to <0 IRE>. • <7.5 IRE> : Sets the black level to <7.5 IRE>. <p>For the RGB signal of <HDMI> mode.</p> <ul style="list-style-type: none"> • <Normal> : Used in a normal environment. • <Low> : Used when the dark parts of an image are too bright.
Overscan	<p>Using this function, you can cut off edge of the a picture when unnecessary information or images appear on the edge of the picture.</p> <p> • Overscan is not supported in [AV] modes.</p> <ul style="list-style-type: none"> • Overscan is supported only when the input signal is an AV Timing (D-Sub) or AV Timing (HDMI) signal. • If <Overscan> is turned off, unnecessary extra parts at the edges of an image may be shown. In this case, turn <Overscan> on.
Film Mode	<p>Using this function, you can set the display mode so that it is optimized for playing movies.</p> <ul style="list-style-type: none"> • <Off>-<Auto> <p> <Film Mode> is only be supported for the [AV], 480i, and 576i of AV Timing (D-Sub) signals.</p>
PC	<p>For PC signals, the four PC functions eliminate or reduce noise that causes unstable screen quality, such as screen shaking. If the noise is not removed using Fine Adjustment, adjust the frequency to the maximum and then perform Fine Adjustment again.</p> <p> • These functions are only enabled for the PC Timing (D-Sub/HDMI) input of the D-Sub terminal.</p> <ul style="list-style-type: none"> • Refer to PC Timing (D-Sub/HDMI). • <Auto Adjustment> : Used to adjust the frequency and phase of PC screen automatically. • <Coarse> : Used to adjust the frequency when vertical lines appear on the PC screen. • <Fine> : Used to fine tune the PC screen. • <Reset> : Using this function, you can reset the PC menu settings to the factory default settings.
Zoom	<p>You can magnify the screen to a size you want.</p> <ul style="list-style-type: none"> • <x1> - <x2> - <x4> - <x8> <p> This function is only enabled when the input signal is a PC Timing (D-Sub/HDMI) signal.</p>

3-5-3. Setup



MENU	DESCRIPTION
Install	<p>To tailor the picture to the installation location, (for example, behind a semi-transparent screen, hanging from the ceiling), you can invert the projected images vertically / horizontally.</p> <ul style="list-style-type: none"> • <Front-Floor> : Normal Image • <Front-Ceiling> : Horizontal/Vertical Reversed Image • <Rear-Floor> : Horizontally Reversed Image • <Rear-Ceiling> : Vertically Reversed Image
Lamp Mode	<p>Using this function, you can set the image brightness by adjusting the amount of light generated by the lamp.</p> <ul style="list-style-type: none"> • <Eco> : This mode is optimized for screens smaller than 100 inches. This mode decreases the lamp brightness and power consumption in order to extend the lamp lifetime and reduce noise and power consumption. • <Bright> : This mode maximizes lamp brightness. Use when the ambient lighting is bright. As the brightness of the lamp increases, the lamp lifetime can be reduced and the noise and power consumption may increase.
Auto Keystone	<p>If video scenes are distorted or tilted, you can compensate for this by setting the <Auto Keystone> function to <On> so that the <V-Keystone> function automatically starts.</p> <ul style="list-style-type: none"> • <Off>-<On>
V-Keystone	<p>If video scenes are distorted or tilted, you can compensate for this using the vertical Keystone function.</p> <ul style="list-style-type: none"> •  The sound output of your projector is temporarily stopped while the keystone is being changed. • Keystone does not compensate for distortion in the On Screen Display (OSD) menu.
Background	<p>You can select an image or screen which will appear when there is no signal from the external device connected to the projector.</p> <ul style="list-style-type: none"> • <Logo>-<Blue>-<Black>
Test Pattern	<p>A default test pattern built into the projector. You can use it as a reference picture to optimize the installation of the projector and to optimize images.</p> <ul style="list-style-type: none"> • <Crosshatch> : You can check whether the picture is distorted or not. • <Screen Size> : You can reference and display picture format sizes such as 1.33 : 1 or 1.78 : 1.

MENU	DESCRIPTION																																			
Video Type	<p>If the screen quality is abnormal as a result of the projector not identifying the input signal type automatically in <PC> or <HDMI> mode, Video Type lets you manually set the input signal.</p> <ul style="list-style-type: none"> In <PC> mode, the menu is only enabled for AV Timing (D-Sub) input signals. For separate H/V sync, it is only enabled for a 1280 x 720p 59.94Hz/60Hz signal. <ul style="list-style-type: none"> <Auto>-<RGB(PC)>-<RGB(AV)>-<YPbPr(AV)> In <HDMI> mode, <Video Type> is only enabled for the 640x480p 59.94Hz/60 Hz and 1280x720p 59.94Hz/60 Hz signals. <ul style="list-style-type: none"> <Auto>-<PC>-<AV> <table border="1" data-bbox="448 528 1414 1084"> <thead> <tr> <th colspan="2">Usage</th> <th>Color, Sharpness, Tint</th> <th>PC menu</th> <th>zoom</th> </tr> </thead> <tbody> <tr> <td>RGB(PC)</td> <td>When connecting the RGB output of a PC to the D-Sub terminal</td> <td>Disabled</td> <td>Enabled</td> <td>Enabled</td> </tr> <tr> <td>RGB(AV)</td> <td>When connecting the RGB output of an AV device (STB, DVD, etc...) to the D-Sub terminal</td> <td>Enabled</td> <td>Disabled</td> <td>Disabled</td> </tr> <tr> <td>YPbPr(AV)</td> <td>When connecting the YPbPr output of an AV device (STB, DVD, etc...) to the D-Sub terminal</td> <td>Enabled</td> <td>Disabled</td> <td>Disabled</td> </tr> <tr> <td>PC</td> <td>When connecting a PC to the HDMI terminal</td> <td>Disabled</td> <td>Disabled</td> <td>Enabled</td> </tr> <tr> <td>AV</td> <td>When connecting an AV device (STB, DVD, etc...) to the HDMI terminal</td> <td>Enabled</td> <td>Disabled</td> <td>Disabled</td> </tr> <tr> <td>Auto</td> <td>Auto settings</td> <td>-</td> <td>-</td> <td>-</td> </tr> </tbody> </table>	Usage		Color, Sharpness, Tint	PC menu	zoom	RGB(PC)	When connecting the RGB output of a PC to the D-Sub terminal	Disabled	Enabled	Enabled	RGB(AV)	When connecting the RGB output of an AV device (STB, DVD, etc...) to the D-Sub terminal	Enabled	Disabled	Disabled	YPbPr(AV)	When connecting the YPbPr output of an AV device (STB, DVD, etc...) to the D-Sub terminal	Enabled	Disabled	Disabled	PC	When connecting a PC to the HDMI terminal	Disabled	Disabled	Enabled	AV	When connecting an AV device (STB, DVD, etc...) to the HDMI terminal	Enabled	Disabled	Disabled	Auto	Auto settings	-	-	-
Usage		Color, Sharpness, Tint	PC menu	zoom																																
RGB(PC)	When connecting the RGB output of a PC to the D-Sub terminal	Disabled	Enabled	Enabled																																
RGB(AV)	When connecting the RGB output of an AV device (STB, DVD, etc...) to the D-Sub terminal	Enabled	Disabled	Disabled																																
YPbPr(AV)	When connecting the YPbPr output of an AV device (STB, DVD, etc...) to the D-Sub terminal	Enabled	Disabled	Disabled																																
PC	When connecting a PC to the HDMI terminal	Disabled	Disabled	Enabled																																
AV	When connecting an AV device (STB, DVD, etc...) to the HDMI terminal	Enabled	Disabled	Disabled																																
Auto	Auto settings	-	-	-																																
Caption	<p>The <Caption> function is supported when the external analog signal from the Video input contains subtitles.</p> <ul style="list-style-type: none"> <Caption> : <Off>-<On> <Mode> : <Caption>-<Text> <Channel> : <1>-<2> <Field> : <1>-<2> <ul style="list-style-type: none">  The <Caption> function will not operate in <PC> (including Component) or <HDMI> mode. Depending on the external signal, a change to the channel or <Field> settings may be required. Each <Channel> and <Field> contains different information. <Field><2> carries additional information to supplement information contained in <Field><1>. (e.g. If English subtitles are provided on <Channel><1>, Spanish subtitles will be provided on <Channel><2>.) 																																			
Reset	<p>Using this function, you can reset various settings to the factory default settings.</p> <ul style="list-style-type: none"> <Factory Default> : Changes the settings to the factory defaults. <Reset Filter Time> : Resets the filter time. 																																			

3-5-4. Option

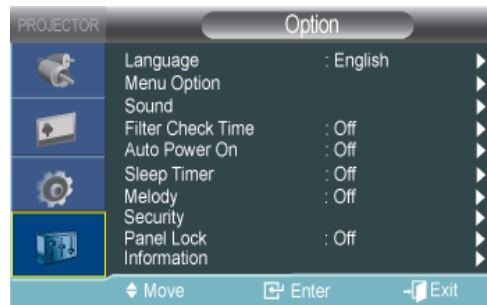

MENU	DESCRIPTION
Language	Using this function, you can select the language used for the menu screen.
Menu Option	<ul style="list-style-type: none"> <Position> : You can move Menu Position up/down/left/right. <Transparency> : You can set the translucency of the menu. <ul style="list-style-type: none"> <High>-<Medium>-<Low>-<Opaque> <Display Time> : You can set the display time of the menu. <ul style="list-style-type: none"> <5 sec>-<10 sec>-<30 sec>-<60 sec>-<90 sec>-<120 sec>-<Stay On>
Sound	The projector comes with an internal 7W (mono) speaker. Use the settings below to adjust the sound. <ul style="list-style-type: none"> <100Hz>-<300Hz>-<1kHz>-<3kHz>-<10kHz>
Filter Check Time	Sets the check period for the filter. (Unit: hours) <ul style="list-style-type: none"> <Off>-<100>-<200>-<400>-<800> <p> If the filter usage time is larger than the filter check period, the filter check message is displayed for 1 minute whenever the projector is turned on.</p> <p>Filter check message: "<Check the filter, and if necessary, clean or replace it.>".</p>
Auto Power On	With Auto Power On, if power is supplied to the projector, it turns on automatically without your pressing the Power button. <ul style="list-style-type: none"> <Off>-<On>
Sleep Timer	With Sleep Timer on, if there is no input signal for the specified time, the projector turns off automatically. <p>(There must be no button input from the remote control or the top of the projector for the specified time)</p> <ul style="list-style-type: none"> <Off>-<10 min>-<20 min>-<30 min>
Melody	Set so that a melody plays when the Projector is turned on or off. <ul style="list-style-type: none"> <Off> - <Low> - <Medium> - <High> <p> Only for SP-M270 / SP-M300</p>
Security	To deter theft, you can set a password that users must enter when the projector powers on. When you set a password, the projector will not work without it. <ul style="list-style-type: none"> <Power On Protection> <ul style="list-style-type: none"> <Off> : Enter your current password and set the protection function to off. <On> : Enter a new password and set the protection function to on. <Change Password> : Change your current password. <p> Use the displayed number keys to enter or change the password.</p>

MENU	DESCRIPTION
Panel Lock	You can disable the buttons on the projector body so that the projector can only be operated by the remote control. <ul style="list-style-type: none"><li data-bbox="395 264 576 293">• <Off> - <On>
Information	You can check external source signals, picture setup, and PC picture adjustment.

4 Troubleshooting

4-1 Before Requesting Service

🔍 Please check the following before requesting After-Sales service. If the problem continues, please contact your nearest Samsung Electronics Service Center.

	Symptoms	Troubleshooting
Installation and Connection	No Power.	Check the power cable connections.
	I want to install my projector on the ceiling.	The ceiling installation bracket is sold separately. Contact your local product distributor.
	External Source can not be selected.	Be sure that the video cable or cables are properly connected to the correct jack or jacks on both ends. If the device is not connected properly, it can not be selected.
Menu and Remote Control	Remote control does not work.	Be sure that the proper external source is selected. Check the battery in the remote. If there is something wrong with it, replace it with a new battery of the recommended size. Be sure to aim the remote at sensor on the back of the unit and at a distance of no more than approximately 32.8 feet(10 m). Remove any obstacles between your remote control and the product. Direct light from 3-way light bulbs or other lighting devices on the remote sensor of the projector may affect the sensitivity and cause the remote control to malfunction. Check if the remote control battery compartment is empty. Check whether the LED indicator on the top of the projector is turned on.
		I cannot select a menu.

	Symptoms	Troubleshooting
Screen and External Source	Cannot see picture images.	<p>Be sure that the power cord of the projector is connected.</p> <p>Be sure that the proper input source is selected.</p> <p>Check that the connectors are properly connected to the ports at the back of the projector.</p> <p>Check the Remote Control batteries.</p> <p>Be sure that the <Color> and<Brightness> settings are not at their lower limit.</p>
	Poor color.	Adjust the <Tint> and <Contrast>.
	Images are not clear.	<p>Adjust the focus.</p> <p>Check if the projector is too far from or too near to the screen.</p>
	Strange noise.	If a strange sound continues, contact your Service Center.
	An operating LED is lit.	Refer to the LED Indications section.
	Lines appear on screen.	On-screen noise may occur when using your PC. Adjust the frequency (refresh rate) of the screen.
	No external device screen is displayed.	Check the operating status for the external device and check whether the adjustable menu items, such as <Brightness> and <Contrast> have been changed correctly in the <Mode> command screen of the Projector menu.
	Only a blue screen appears.	Be sure to properly connect the external devices. Check the connection cables again.
Screen appears in black and white or in an odd color, or the screen is too dark or bright.	<p>As mentioned above, check the adjustable items such as <Brightness>, <Contrast>, or <Color> in the menu.</p> <p>If you want to restore various settings to their factory defaults, run <Factory Default> from the menu.</p>	

5 More Information

5-1 Specifications

5-1-1. SP-M200 / SP-M220 / SP-M250

MODEL		SP-M200	SP-M220	SP-M250
Panel	Size	0.63 inches 3P LCD		
	Resolution	XGA (1024 x 768)		
Aspect ratio		4:3		
Power	Power Consumption	240 W	240 W	260 W
	Voltage	100 ~ 240 V AC, 50/60 Hz		
Lamp	Power Consumption	180 W	180 W	200 W
	Life Time	3,000 Hours (Eco : 5,000 Hours)		
Dimension		279 x 229 x 79 mm / 10.98 x 9.02 x 3.11 inches		
Weight		2.5 Kg / 5.5 lbs		
Key Features	Brightness	2,000 ANSI	2,200 ANSI	2,500 ANSI
	Contrast	500:1		
	Projection Range	1 m ~ 14 m / 39.37 inches ~ 551.18 inches		
	Keystone	Vertical (± 20 °)		
	Zoom Adjustment ff	Manual		
	Focus Adjustment	Manual		
	Screen Size (Diagonal)	Diagonal 30 inches ~ 400 inches		
	Lens	F=1.7 ~ 1.87, f=19.2mm ~ 23 mm		
	Zoom Ratio	1:1.2		
Input signal	D-Sub 15p	Analog RGB, analog YPbPr		
	HDMI	Digital RGB, digital YPbPr		
	RCA x 1	Composite video		
Speaker		7 W (Mono)		
User Environ- ment	Temperature and Humidity	Operating : Temperature 41 °F ~ 95 °F (5 °C ~ 35 °C), Humidity 20 % ~ 80 % (Non-condensing)		
		Storage : Temperature 14 °F ~ 140 °F (-10 °C ~ 60 °C), Humidity 10 % ~ 90 % (Non-condensing)		
Noise		Eco : 31dB, Bright : 35dB		

5-1-2. SP-M270 / SP-M300

MODEL		SP-M270	SP-M300
Panel	Size	0.63 inches 3P LCD	
	Resolution	XGA (1024 x 768)	
Aspect ratio		4:3	
Power	Power Consumption	280 W	295 W
	Voltage	100 ~ 240 V AC, 50/60 Hz	
Lamp	Power Consumption	230 W	
	Life Time	3,000 Hours (Eco : 5,000 Hours)	
Dimension		279 x 229 x 79 mm / 10.98 x 9.02 x 3.11 inches	
Weight		2.74 Kg / 6.0 lbs	
Key Features	Brightness	2,700 ANSI	3,000 ANSI
	Contrast	2000:1 (Only in Dynamic of picture mode)	
	Projection Range	1 m ~ 14 m / 39.37 inches ~ 551.18 inches	
	Keystone	Vertical (± 20 °)	
	Zoom Adjustment	Manual	
	Focus Adjustment	Manual	
	Screen Size (Diagonal)	Diagonal 30 inches ~ 400 inches	
	Lens	F=1.7 ~ 1.87, f=19.2mm ~ 23 mm	
	Zoom Ratio	1:1.2	
Input signal	D-Sub 15p	Analog RGB, analog YPbPr	
	HDMI	Digital RGB, digital YPbPr	
	RCA x 1	Composite video	
Output signal	D-Sub 15p	Analog RGB, analog YPbPr	
Speaker		7 W (Mono)	
User Environment	Temperature and Humidity	Operating : Temperature 41 °F ~ 95 °F (5 °C ~ 35 °C), Humidity 20 % ~ 80 % (Non-condensing)	
		Storage : Temperature 14 °F ~ 140 °F (-10 °C ~ 60 °C), Humidity 10 % ~ 90 % (Non-condensing)	
Noise		Eco : 31dB, Bright : 35dB	

Class B (Information Communication equipment for residential use)

This device is registered for EMC requirements for home use (Class B). It can be used in all areas. (Class B equipment emits less electromagnetic waves than Class A equipment.)

-  The LCD panel used in the LCD projector consists of hundreds of thousands of fine pixels. Like other video display devices, the LCD panel may contain bad pixels which do not operate. When shipping a product, the conditions for identifying bad pixels and the number of bad pixels that a LCD panel is allowed to contain are strictly managed in accordance with the relevant specified standards by the LCD panel manufacturer and our company. Though a screen may have some dead pixels, this does not affect the overall screen quality and the lifetime of the product.

Communication Format (Complies with the RS232C Standard)

- Baud rate : 9,600 bps
- parity : None
- Data bits : 8, stop bit : 1
- Flow Control : None

Serial Communication Protocol

1. Command Packet Structure [7bytes]

0x08	0x22	cmd1	cmd2	cmd3	value	CS
------	------	------	------	------	-------	----

- A command packet consists of 7 bytes in total.
 - The two bytes 0x08 and 0x22 signify that the packet is for serial communication.
 - The following 4 bytes represent a pre-defined command that can be defined by the user.
 - The last byte is the checksum which checks the validity of the current packet.
-
- Header [2 Byte]: Pre-defined values fixed to 0x08 and 0x22.
 - Cmd1 [1 Byte]: The first value of the code defined in the command list (Hexadecimal)
 - Cmd2 [1 Byte]: The second value of the code defined in the command list (Hexadecimal)
 - Cmd3 [1 Byte]: The third value of the code defined in the command list (Hexadecimal)
 - Value [1 Byte]: Input parameter for the command (Default: 0) (Hexadecimal)
 - CS [1 Byte]: Checksum (the 2's complement of the sum of all the values except for the CS value.)
- #### 2. Response Packet Structure [3 Bytes]

1. Success

0x03	0x0C	0xF1
------	------	------

2. Fail

0x03	0x0C	0xFF
------	------	------

- When the received packet from an external device has a valid value, a Success packet is sent. Otherwise, a Fail packet is sent.
- A Fail packet is sent if:
 - The received packet length is not equal to 7 bytes.
 - The 2 byte packet header value is not equal to 0x08, 0x22.
 - The check sum is incorrect.
- Failure detection by an external device
 - An external device classifies the packet as Fail if it does not receive a Success packet within 100ms.

Command Table

CONTROL ITEM				CMD1	CMD2	CMD3	VALUE	
General	Power	Power	Display OSD / Power On	0x00	0x00	0x00	0	
			OK				1	
			Cancel				2	
			Direct Power Off				3	
	Volume	Direct Volume		0x01	0x00	0x00	(0~100)	
			Continuous				Up	0x01
		Down					0x02	0
	Mute		On	0x02	0x00	0x00	0	
			Off				1	
	Blank		On	0x03	0x00	0x00	0	
			Off				1	
	Still		On	0x04	0x00	0x00	0	
			Off				1	
	Power On Protection		(0~9)	0x05	0x00	0x00	(0~9)	
Input	Source List	AV	AV	0x0A	0x00	0x01	0	
		PC	PC			0x03	0	
		HDMI	HDMI			0x04	0	

CONTROL ITEM				CMD1	CMD2	CMD3	VALUE	
Picture	Mode	Dynamic		0x0B	0X00	0x00	0	
		Standard					1	
		Presentation					2	
		Text					3	
		Movie					4	
		Game					5	
		User					6	
	Contrast	0~100			0X02	0x00	(0~100)	
	Brightness	0~100			0X03	0x00	(0~100)	
	Sharpness	0~100			0X04	0x00	(0~100)	
	Color	0~100			0X05	0x00	(0~100)	
	Tint (G/R)	G50 / R50			0x06	0x00	(0~100)	
	Color Tone	Cool2			0x0A	0x00	1	
		Cool1					2	
		Warm1					3	
		Warm2					4	
	WB	R offset			0x0B	0x00	(0~100)	
		G offset					0x01	(0~100)
		B offset					0x02	(0~100)
		R gain					0x03	(0~100)
		G gain					0x04	(0~100)
B gain				0x05			(0~100)	

CONTROL ITEM				CMD1	CMD2	CMD3	VALUE
Picture	Gamma	-3~3		0x0B	0x0C	0x00	(0~6)
	Save	Display OSD			0x0D	0x00	0
		OK					1
		Cancel					2
		Direct Save					3
	Reset				0x0E	0x00	0
	Size	Normal			0x0F	0x00	0
		Zoom1					1
		Zoom2					2
		16:9					3
	Digital NR	Off			0x10	0x00	0
		On					1
	Black Level	0 IRE/NOR- MAL			0x11	0x00	0
		7.5 IRE/LOW					1
	Overscan	Off			0x12	0x00	0
		On					1
	Film Mode	Off			0x13	0x00	0
		Auto					1
	PC	Auto adjust- ment			0x14	0x00	0
		Coarse	UP		0x15	0x00	0
			DOWN				1
		fine	Up		0x16	0x00	0
			DOWN				1
		Reset	Display OSD		0x17	0x00	0
			OK				1
			Cancel				2
	Direct Reset		3				
	Zoom	x1			0x18	0x00	0
		x2					1
		x4					2
		x8					3
		LEFT			0x19	0x00	0
		RIGHT					1
		Up					2
		Down					3

CONTROL ITEM				CMD1	CMD2	CMD3	VALUE
Picture	Horizontal Position	Continuous	LEFT	0x0B	0x1A	0x00	0
			RIGHT				1
	Vertical Position	Continuous	DOWN		0x1B	0x00	0
			Up				1

CONTROL ITEM				CMD1	CMD2	CMD3	VALUE
Setup	Install	Front-Floor		0x0C	0x00	0x00	0
		Front-Ceiling					1
		Rear-Floor					2
		Rear-Ceiling					3
	Lamp Mode	ECO			0x01	0x00	0
		Bright					2
	Keystone	V-Keystone	-50~50		0x02	0x00	(0~100)
		Auto Key-stone	Off				0x02
			On			1	
	Background	Logo			0x03	0x00	0
		Blue					1
		Black					2
	Test Pattern	Crosshatch		0x04	0x00	0	
		Screen size				1	
		Pattern Off				2	
	Video Type	Auto		0x05	0x00	0	
		RGB(PC)				1	
		RGB(AV)				2	
		YPbPr(AV)				3	
		PC				4	
		AV				5	
	Reset	Factory Default	Display OSD	0x06	0x00	0	
			Ok			1	
			Cancel			2	
			Direct Factory Default			3	
		Reset Filter Time	Display OSD			0x01	0
			Ok				1
			Cancel				2
			Direct Reset Filter Time				3
	Caption	Caption	Off	0x07	0x00	0	
			On			1	
		Mode	Caption			0x01	0
Text			1				
Channel		1	0x02			0	
		2				1	
Field		1	0x03			0	
		2				1	

CONTROL ITEM				CMD1	CMD2	CMD3	VALUE
Option	Language	English		0x0D	0x00	0x00	0
		Deutsch					1
		Nederlands					2
		Español					3
		Français					4
		Italiano					5
		Svenska					6
		Português					7
		Русский					8
		中国語					9
		한국어					10
		Türkçe					11
	ไทย		12				
	Menu Option	Position	LEFT		0x01	0x00	0
			RIGHT				1
UP				2			
DOWN				3			
Transpar- ency		High		0x02	0x00	0	
		Medium				1	
		Low				2	
		Opaque				3	
Display Time		5 sec		0x03	0x00	0	
		10 sec				1	
		30 sec				2	
		60 sec				3	
		90 sec				4	
	120 sec		5				
	Stay On		6				

CONTROL ITEM				CMD1	CMD2	CMD3	VALUE	
Option	Sound	100Hz	Up	0x0D	0x04	0x01	0	
			Down				1	
		300Hz	Up			0x02	0	
			Down				1	
		1KHz	Up			0x03	0	
			Down				1	
		3KHz	Up			0x04	0	
			Down				1	
		10KHz	Up			0x05	0	
			Down				1	
		Filter Check Time	Off			0x05	0x00	0
			100					1
	200		2					
	400		3					
	800		4					
	Auto Power ON	Off	0x06		0x00	0		
		On				1		
	Sleep Timer	Off	0x07		0x00	0		
		10 min				1		
		20 min				2		
		30 min				3		
	Information		0x08		0x00	0		
	Panel Lock	Off	0x0A		0x00	0		
		On				1		
	Melody (Only for SP-M270 / SP-M300)	Off	0x0B		0x00	0		
		Low				1		
		Medium				2		
		High				3		

5-3 Contact SAMSUNG WORLDWIDE

 If you have any questions or comments relating to Samsung products, please contact the SAMSUNG customer care center.

NORTH AMERICA		
U.S.A	1-800-SAMSUNG(726-7864)	http://www.samsung.com
CANADA	1-800-SAMSUNG(726-7864)	http://www.samsung.com
MEXICO	01-800-SAMSUNG(726-7864)	http://www.samsung.com
LATIN AMERICA		
ARGENTINA	0800-333-3733	http://www.samsung.com
BRAZIL	0800-124-421 4004-0000	http://www.samsung.com
CHILE	800-SAMSUNG(726-7864)	http://www.samsung.com
COLOMBIA	01-8000112112	http://www.samsung.com
COSTA RICA	0-800-507-7267	http://www.samsung.com
ECUADOR	1-800-10-7267	http://www.samsung.com
EL SALVADOR	800-6225	http://www.samsung.com
GUATEMALA	1-800-299-0013	http://www.samsung.com
HONDURAS	800-7919267	http://www.samsung.com
JAMAICA	1-800-234-7267	http://www.samsung.com
NICARAGUA	00-1800-5077267	http://www.samsung.com
PANAMA	800-7267	http://www.samsung.com
PUERTO RICO	1-800-682-3180	http://www.samsung.com
REP. DOMINICA	1-800-751-2676	http://www.samsung.com
TRINIDAD & TOBAGO	1-800-SAMSUNG(726-7864)	http://www.samsung.com
VENEZUELA	0-800-100-5303	http://www.samsung.com
EUROPE		
AUSTRIA	0810 - SAMSUNG(7267864,€ 0.07/min)	http://www.samsung.com
BELGIUM	02-201-24-18	http://www.samsung.com/be (Dutch) http://www.samsung.com/be_fr (French)
CZECH	800 - SAMSUNG (800-726786)	http://www.samsung.com
	Distributor pro Českou republiku: Samsung Zrt., česká organizační složka, Oasis Florenc, Sokolovská394/17, 180 00, Praha 8	
DENMARK	70 70 19 70	http://www.samsung.com
EIRE	0818 717100	http://www.samsung.com
ESTONIA	800-7267	http://www.samsung.com
FINLAND	030 - 6227 515	http://www.samsung.com
FRANCE	01 48 63 00 00	http://www.samsung.com

EUROPE		
GERMANY	01805 - SAMSUNG (726-7864,€ 0,14/Min)	http://www.samsung.com
HUNGARY	06-80-SAMSUNG(726-7864)	http://www.samsung.com
ITALIA	800-SAMSUNG(726-7864)	http://www.samsung.com
LATVIA	8000-7267	http://www.samsung.com
LITHUANIA	8-800-77777	http://www.samsung.com
LUXEMBURG	261 03 710	http://www.samsung.com
NETHERLANDS	0900 - SAMSUNG (0900-7267864) (€ 0,10/Min)	http://www.samsung.com
NORWAY	815-56 480	http://www.samsung.com
POLAND	0 801 1SAMSUNG (172678) 022 - 607 - 93 - 33	http://www.samsung.com
PORTUGAL	80820 - SAMSUNG (726-7864)	http://www.samsung.com
SLOVAKIA	0800-SAMSUNG(726-7864)	http://www.samsung.com
SPAIN	902 - 1 - SAMSUNG (902 172 678)	http://www.samsung.com
SWEDEN	0771 726 7864 (SAMSUNG)	http://www.samsung.com
SWITZERLAND	0848-SAMSUNG(7267864, CHF 0.08/min)	http://www.samsung.com/ch http://www.samsung.com/ch_fr (French)
U.K	0845 SAMSUNG (7267864)	http://www.samsung.com
CIS		
ARMENIA	0-800-05-555	
AZERBAIJAN	088-55-55-555	
BELARUS	810-800-500-55-500	
GEORGIA	8-800-555-555	
KAZAKHSTAN	8-10-800-500-55-500	
KYRGYZSTAN	00-800-500-55-500	http://www.samsung.com
MOLDOVA	00-800-500-55-500	
RUSSIA	8-800-555-55-55	http://www.samsung.com
TADJIKISTAN	8-10-800-500-55-500	http://www.samsung.com
UKRAINE	0-800-502-000	http://www.samsung.com/ua http://www.samsung.com/ua_ru
UZBEKISTAN	8-10-800-500-55-500	http://www.samsung.com
ASIA PACIFIC		
AUSTRALIA	1300 362 603	http://www.samsung.com
CHINA	400-810-5858 010-6475 1880	http://www.samsung.com
HONG KONG	(852) 3698 - 4698	http://www.samsung.com/hk http://www.samsung.com/hk_en/

ASIA PACIFIC		
INDIA	3030 8282 1800 110011 1800 3000 8282 1800 266 8282	http://www.samsung.com
INDONESIA	0800-112-8888 021-5699-7777	http://www.samsung.com
JAPAN	0120-327-527	http://www.samsung.com
MALAYSIA	1800-88-9999	http://www.samsung.com
NEW ZEALAND	0800 SAMSUNG (0800 726 786)	http://www.samsung.com
PHILIPPINES	1-800-10-SAMSUNG(726-7864) 1-800-3-SAMSUNG(726-7864) 1-800-8-SAMSUNG(726-7864) 02-5805777	http://www.samsung.com
SINGAPORE	1800-SAMSUNG(726-7864)	http://www.samsung.com
TAIWAN	0800-329-999	http://www.samsung.com
THAILAND	1800-29-3232 02-689-3232	http://www.samsung.com
VIETNAM	1 800 588 889	http://www.samsung.com
MIDDLE EAST & AFRICA		
BAHRAIN	8000-4726	
JORDAN	800-22273	
SOUTH AFRICA	0860-SAMSUNG(726-7864)	http://www.samsung.com
TURKEY	444 77 11	http://www.samsung.com
U.A.E	800-SAMSUNG(726-7864)	http://www.samsung.com

Correct Disposal of This Product (Waste Electrical & Electronic Equipment) - Europe only



(Applicable in the European Union and other European countries with separate collection systems)

This marking on the product, accessories or literature indicates that the product and its electronic accessories (e.g. charger, headset, USB cable) should not be disposed of with other household waste at the end of their working life. To prevent possible harm to the environment or human health from uncontrolled waste disposal, please separate these items from other types of waste and recycle them responsibly to promote the sustainable reuse of material resources.

Household users should contact either the retailer where they purchased this product, or their local government office, for details of where and how they can take these items for environmentally safe recycling.

Business users should contact their supplier and check the terms and conditions of the purchase contract. This product and its electronic accessories should not be mixed with other commercial wastes for disposal.

Correct disposal of batteries in this product - Europe only



(Applicable in the European Union and other European countries with separate battery return systems.)

This marking on the battery, manual or packaging indicates that the batteries in this product should not be disposed of with other household waste at the end of their working life. Where marked, the chemical symbols Hg, Cd or Pb indicate that the battery contains mercury, cadmium or lead above the reference levels in EC Directive 2006/66. If batteries are not properly disposed of, these substances can cause harm to human health or the environment.

To protect natural resources and to promote material reuse, please separate batteries from other types of waste and recycle them through your local, free battery return system.