

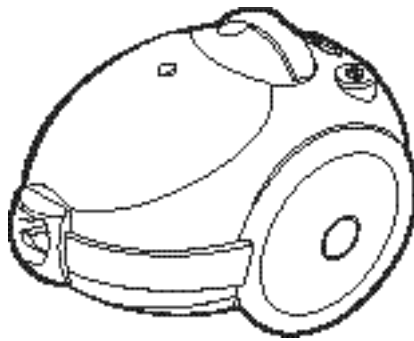

Operating Instructions

VACUUM CLEANER



h Before operating this unit, please read the instructions carefully.



FEATURES

Features include automatic cord rewind and dust indicator.

IMPORTANT SAFEGUARDS

1. Read all instructions carefully. Before switching on, make sure that the voltage of your electricity supply is the same as that indicated on the rating plate on the bottom of the cleaner.
2. **WARNING:** Do not use the vacuum cleaner when rug or floor is wet.
3. Close supervision is necessary when any appliance is used by or near children. Do not allow the vacuum cleaner to be used as a toy. Do not allow the vacuum cleaner to run unattended at any time. Use the vacuum cleaner only for its intended use as described in the instructions.
4. Do not use the vacuum cleaner without a dust bag. Change the dust bag before it is full in order to maintain best efficiency.
5. Do not use the vacuum cleaner to pick up matches, live ashes or cigarette butts. Keep the vacuum cleaner away from stoves and other heat sources. Heat can deform and discolour the plastic parts of the unit.
6. Avoid picking up hard, sharp object with the vacuum cleaner as they may damage the cleaner parts. Do not stand on the hose assembly. Do not put a weight on the hose. Do not block the suction or the exhaustion part.
7. Switch the vacuum cleaner off at the machine before unplugging from the electrical outlet. Grasp the plug to disconnect from power outlet to avoid damage to cord, plug, prongs or socket. Always disconnect cord from electrical outlet before changing the dust bag.
8. The use of an extension cord is not recommended.
9. If your vacuum cleaner is not operating correctly, switch off the power supply and consult an authorized service agent.
10. Do not attempt to replace a damaged power supply cord. Only the manufacturer or qualified service personnel can replace power cords. Serious injury may result.

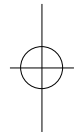
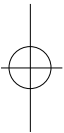

WARNING

1. Do not use to suck up water.
2. Do not immerse in water for cleaning.
3. The hose should be checked regularly and must not be used if damaged.

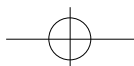

IDENTIFICATIONS OF PARTS

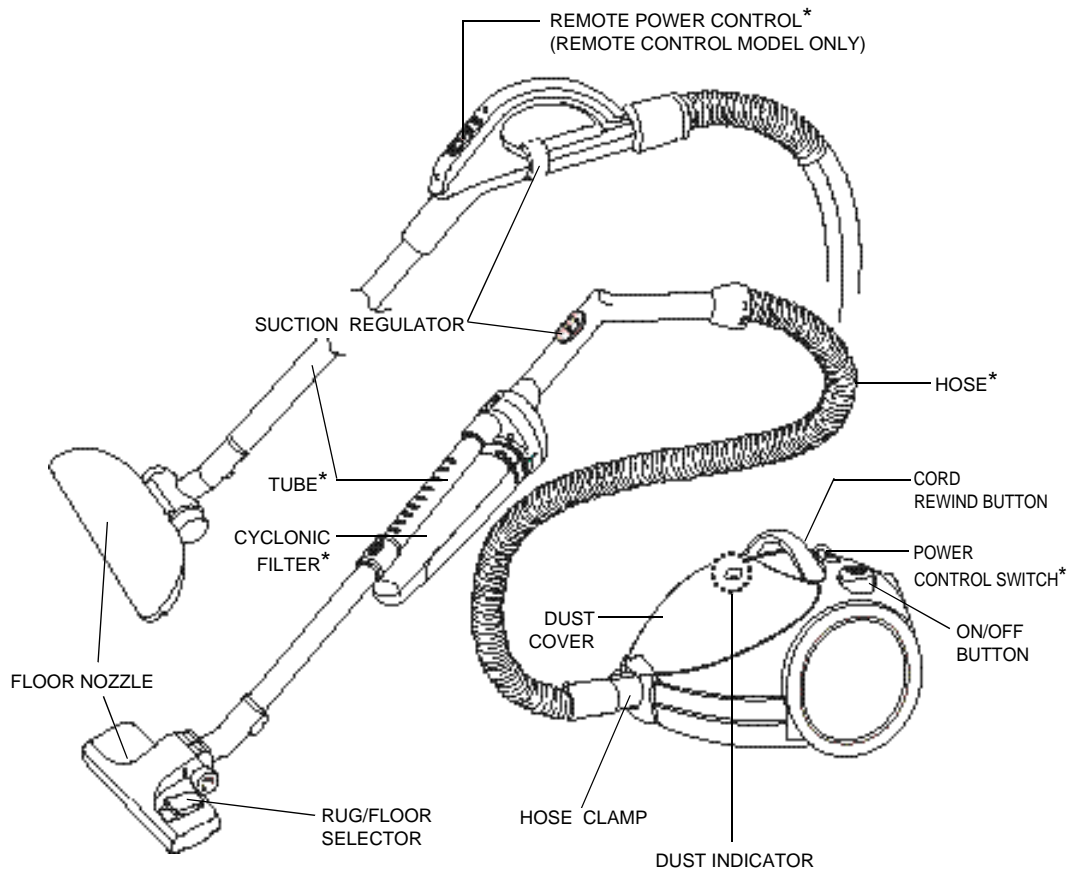

► Features marked * may vary according to model.

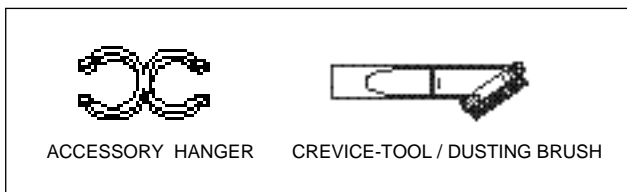

ASSEMBLING THE VACUUM-CLEANER SO THAT IT IS READY FOR USE

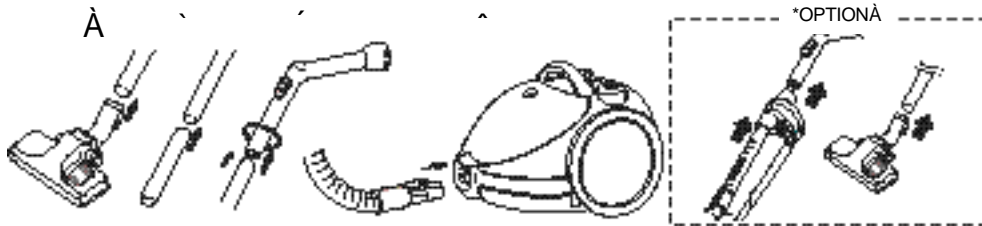

1. Slide the free end of the extension wand into the nozzle tube.
 2. Slide the narrow end of one extension wand into the other extension wand.
 3. Slide the extension wand into the handle end of the hose.
 4. Slide the hose clamp into the suction inlet of the unit.
- * **Option A** Assemble the CYCLONIC FILTER with the handle and extension wand (depending on model).
 Adjusting the telescopic tubes (depending on model).

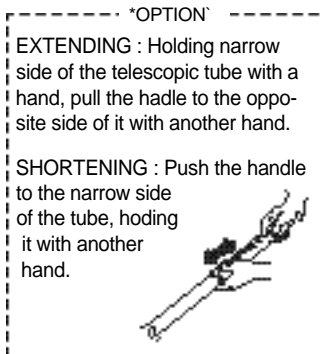

USAGE OF FLOOR NOZZLE

FOR RUG / FLOOR SELECTOR

Before use make sure that the position of the selector is in the right position for the type of surface to be cleaned.

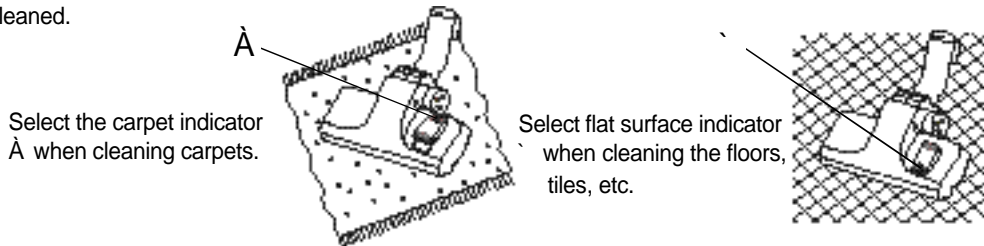

FOR UNIVERSAL BRUSH

Use the floor nozzle for all cleaning surfaces.

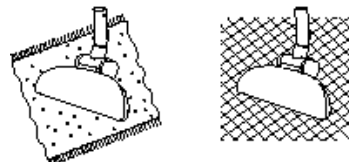

NOTE: For optimum efficiency, clean floor brush with crevice tool.



SUCTION POWER CONTROL(ONLY VARIABLE CONTROL TYPES)

Your cleaner has variable electronic suction control to give you greater versatility. Select the most suitable position according to cleaning needs. The suction capacity can be regulated steplessly by moving the slide to the desired position. Vacuum power can be adjusted to suit different situations using the power control.

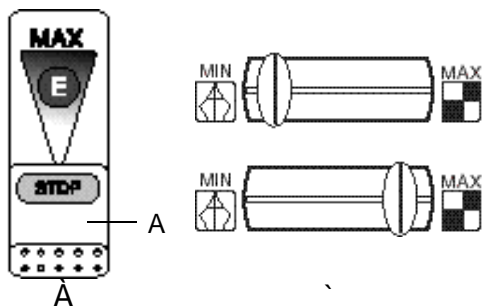

REMOTE CONTROL TYPE

SLIDE THE PART "A" IN THE STOP POSITION

Vacuum cleaner switches off (stand by mode)

SLIDE THE PART "A" TOWARDS MAX

Suction capacity increases steplessly up to MAX.

BODY CONTROL TYPE

MIN - For delicate fabrics, like curtains.

MAX - For hard floors and heavily soiled carpets.

DUST INDICATOR

You may continue cleaning until the dust indicator changes and displays red colour. This means the dust bag is full and needs to be replaced.

If the indicator suddenly displays red and the cleaner loses suction power while in use, turn your cleaner off and check whether the hose, pipe or nozzle is clogged.

When you check bag status by indicator, set motor power on maximum position.

REPLACING THE DUST BAG

NOTE : Hose must be disconnected before changing bag.

Replace the dust bag as soon as it is full.

1. To open the dust cover of the dust bag compartment, lift the front of cover upwards.
2. Remove the dust bag from the cleaner.
3. Dispose of the full bag. Insert the cardboard bag collar of the dust bag as far as it can go on the suction inlet along the slide guide. Position the dust bag so that no part of the bag is pinched.
4. Press the front of dust cover down lightly until it re-locks.

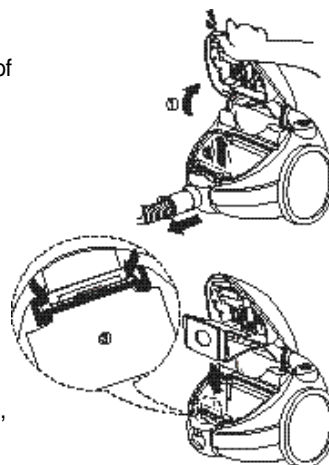

NOTE : In the absence of a dust bag, the cover cannot be closed, do not close forcibly.

IF YOU USE PAPER DUST BAG

After using, if the paper dust bag is full of dust, dispose the paper bag. It should not be used again.

IF YOU USE CLOTH FILTER BAG

After using, if the cloth filter bag is full of dust, clean the cloth filter bag and use it again. After washing, it should be dried thoroughly. Serious injury may result.

NOTE: There are two types of dust bag according to the model. One is paper dust bag type, the other is a cloth filter bag type.

CORD STORAGE

To extend the power cord for use, grasp the plug and gently pull out from the vacuum cleaner. When removing the power cord from the electrical outlet, switch off the power and grasp the plug. Your cleaner is equipped with an automatic rewind button. After cleaning, switch off power and disconnect the plug from the electrical outlet then press on the cord rewind button. The cord will be rewound automatically.

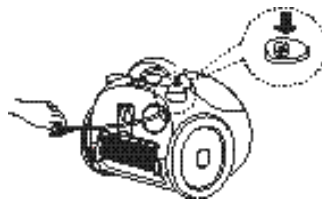

ON / OFF BUTTON

With the cord plugged into an electrical outlet, start or stop the vacuum cleaner by pushing lightly on the switch downwards.

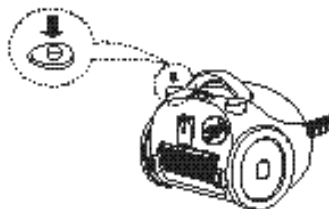

PARK POSITION

Located on the top rear side of the vacuum cleaner, there is a support for a convenient park position during pauses when using the nozzle.

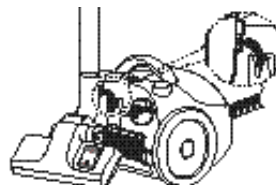

STANDS ON END

Your cleaner is designed to stand firmly upright for cleaning or storage. Use in this manner and it takes up minimum space, and allows you to work in the narrowest spaces.

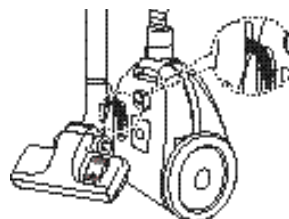

USING THE ACCESSORIES

CREVICE

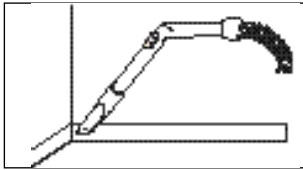

Crevice tool radiators, crevices, corners, between cushions.

DUSTING

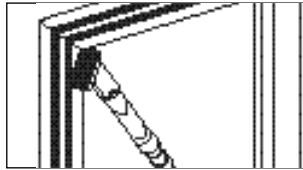

Dusting brush for furniture, shelves, books, etc.

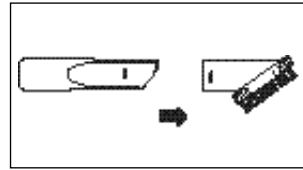

- Before use, assemble the dusting brush to the crevice tool

TOOL STORAGE

Your cleaner features an tool storage device. Assemble the accessory hanger on to the extension tube. It can be used to store the cleaning tool while they are not in use. This tool can be separated into two parts.

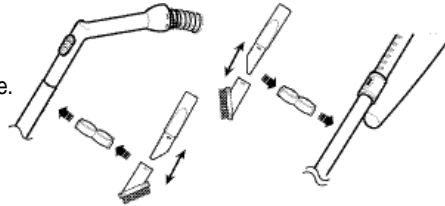

CARE OF FILTERS

► SECONDARY FILTER

To protect the motor, your cleaner features a secondary filter at the front of the motor in the dust compartment. Do not allow the filter to become clogged. Suction power reduction or motor damage may result. After cleaning the secondary filter attach it in place.

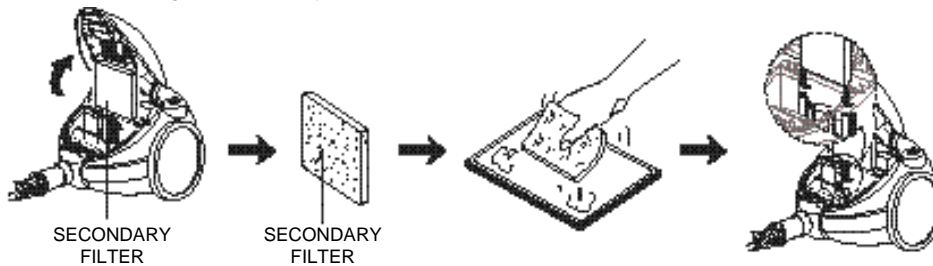

► OUTLET FILTER

1) Separate the exhaust filter.



2) Reassemble it after cleaning or replacing the filter in the reverse order.

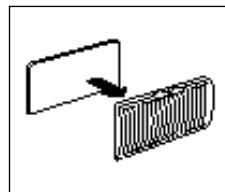

NOTE: The filters must be completely dried before being replaced in the dust compartment.

CYCLONIC FILTER(ONLY CYCLONIC FILTER TYPES)

You can use a dust bag in your cleaner for a long time thanks to the Cyclonic Filter system and it maintain the maximum cleaning efficiency.

The larger particle of dust filtered from Cyclonic Filter remain in Dust Barrel when suctioned air and dust revolves in the Cyclonic Filter. So the dust bag contains only smaller ones.

When the Dust Barrel is filled with dust up to the indicating line, it needs disposing and cleaning. Dust Barrel can be cleaned in water.

1. Turn the Dust Barrel to the left and pull it.
2. Disconnect the Cyclonic Filter from extension wand and handle.
3. Remove thread and hair tangled around the net.
4. After cleaning the Dust Barrel and Cyclonic Filter, connect the Cyclonic Filter with extension wand and handle (washed part should be dried in the shade thoroughly before assembling).
5. Push and turn the Dust Barrel to the right.

Adjust indicating marks each other carved on Dust Barrel and Cyclonic Filter.

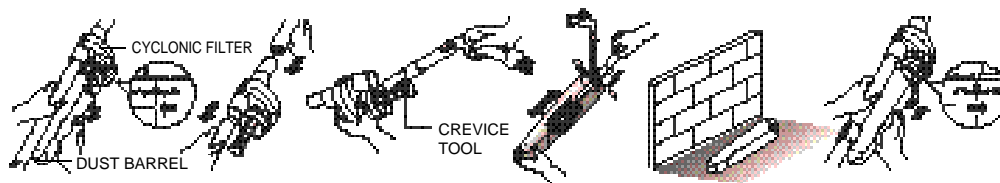

IF YOU HAVE A PROBLEM

This appliance was inspected thoroughly and was in good operating condition when it was shipped from the factory.

If a minor problem occurs, it can usually be solved quite easily when the cause is found. Therefore, this check list is provided for your convenience.

PROBLEM	POSSIBLE CAUSE	POSSIBLE SOLUTION
Cleaner will not run.	<ol style="list-style-type: none"> 1. Not firmly plugged in. 2. No voltage in wall plug. 	<ol style="list-style-type: none"> 1. Plug in firmly. 2. Check fuse or breaker.
Cleaner does not Pick up properly	<ol style="list-style-type: none"> 1. Dust bag is full. 2. Hose clogged with a large object. 	<ol style="list-style-type: none"> 1. Change dust bag. 2. Remove the substance.

CODE-NO:DJ68-00053P REV(0.0)