

Monitor

User Manual

The color and the appearance may differ depending on the product, and the specifications are subject to change without prior notice to improve the performance.



Table Of Contents

MAJOR SAFETY PRECAUTIONS

Before You Start	1-1
Custody and Maintenance	1-2
Cleaning the Monitor	1-3
Safety Precautions	1-4

INSTALLING THE PRODUCT

Package Contents	2-1
Installing the Stand	2-2
Installing the Stand for the Wall Mount	2-3
Connecting with a PC	2-4
Kensington Lock	2-5

USING THE PRODUCT

Setting the Optimal Resolution	3-1
Standard Signal Mode Table	3-2
Installing the Device Driver	3-3
Product Operating Buttons	3-4
Using the Screen Adjustment Menu (OSD: On Screen Display)	3-5

INSTALLING THE SOFTWARE

Natural Color	4-1
MagicTune	4-2
MultiScreen	4-3

TROUBLESHOOTING

Monitor Self-Diagnosis	5-1
Before Requesting Service	5-2
FAQ	5-3



MORE INFORMATION

Specifications	6-1
Power Saving Function	6-2
Contact SAMSUNG WORLDWIDE	6-3
Correct Disposal of This Product (Waste Electrical & Electronic Equipment)	6-4

1 Major Safety Precautions

1-1 Before You Start

Icons used in this manual

ICON	NAME	MEANING
	Caution	Indicates cases where the function may not work or the setting may be canceled.
	Note	Indicates a hint or tip to operate a function.

Using this Manual

- Make yourself fully aware of the safety precautions before using this product.
- If a problem occurs, refer to the 'Troubleshooting' section.

Copyright Notice

The contents of this manual are subject to change without prior notice for performance improvement.

Copyright © 2011 Samsung Electronics Co., Ltd. All Rights Reserved.

The copyright of this manual is reserved by Samsung Electronics, Co., Ltd.

The contents of this manual may not be partially or in whole reproduced, distributed or used in any form without the written permission of Samsung Electronics, Co., Ltd.

The SAMSUNG logo and SyncMaster are the registered trademarks of Samsung Electronics, Co., Ltd.

Microsoft, Windows and Windows NT are the registered trademarks of Microsoft Corporation.

VESA, DPM and DDC are the registered trademarks of the Video Electronics Standard Association.

The ENERGY STAR® logo is the registered trademark of the U.S. Environmental Protection Agency.

All other trademarks mentioned herein belong to their respective companies.

1-2 Custody and Maintenance

External Surface and Screen Maintenance

Clean the product with a soft dry cloth.

- Do not clean the product with an inflammable substance such as benzene or thinner or with a wet cloth. This may result in a problem with the product.
- Do not scratch the screen with your fingernails or a sharp object.
This may result in scratches or damage to the product.
- Do not clean the product directly by spraying water onto the product.
If water enters the product, it may result in fire, electric shock or a problem with the product.
- A white stain may be generated on the surface of the high-glossy model due to the inherent characteristics of the material, if a supersonic humidifier is used.

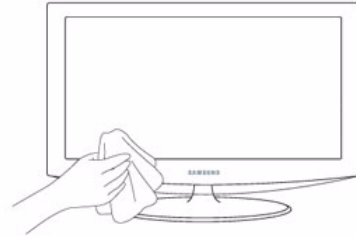

 The appearance and the color may differ depending on the model.

Securing the Installation Space

- Keep the required distances between the product and other objects (e.g. walls) to ensure proper ventilation. Failing to do so may result in fire or a problem with the product due to an increase in the internal temperature. Install the product so the required distances shown in the figure are kept.

 The appearance may differ depending on the product.

When installing the product with a stand

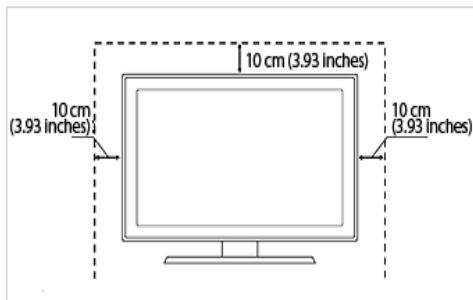

When installing the product with a wall-mount

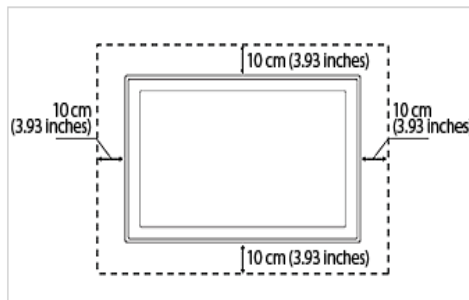

About persistent images

- Displaying a still image for a long time may create a persistent image or stain on the screen. If you do not use the product for a long time, set the power-saving mode or screen saver.
- Due to technological constraints of the panel manufacturer, the images generated by this product may appear either brighter or darker than normal for approximately 1 ppm (parts per million) pixels.

The number of sub-pixels by panel type: The number of Sub-Pixels = Max. Horizontal Resolution x Max. Vertical Resolution x 3

Example) If the maximum resolution is 1920 x 1080, the number of sub-pixels is 1920 x 1080 x 3 = 6,220,800.

1-3 Cleaning the Monitor

Cleaning the Monitor

- The panel and exterior of the cutting-edge monitor scratch easily and require careful attention. Clean the monitor according to the following steps.

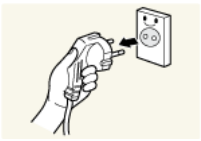

1. Power off the monitor and PC.
2. Disconnect the power cable from the monitor.

 To avoid electric shock, be sure you disconnect the cable by gripping the plug and do not touch the cable with wet hands.



3. Wipe the monitor using a soft, slightly damp cloth that has been squeezed .



- Do not use a cleaning agent that contains alcohol or solvents, or that is surface active. Otherwise, the exterior may discolor or crack or the panel coating may come off.



- Do not spray water or cleaning agent directly onto the monitor. Otherwise, the liquid may sink into the monitor and cause a fire, electric shock, or failure.

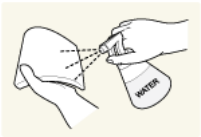

4. Clean the exterior of the monitor using a soft cloth dampened with a small amount of water.

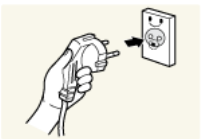

5. Connect the power cable to the monitor after you have finished cleaning.
6. Power on the monitor and PC.

Precautions for Storage

- Using an ultrasonic humidifier may cause white stains on a highly glossy product.

 Be sure you contact the nearest service center (paid service) for cleaning the inside of the monitor.

1-4 Safety Precautions

Icons used for safety precautions

ICON	NAME	MEANING
	Warning	Failing to follow the precautions marked with this sign, may result in a serious injury or even a fatality.
	Caution	Failing to follow the precautions marked with this sign, may result in a personal injury or property damage.

Meaning of Signs



Do not perform.



Must be followed.



Do not disassemble.



The power plug must be unplugged from the wall outlet.



Do not touch.



Must be grounded to prevent electric shock.

Power Related

The product image used in the following pictures for your reference may look different from the actual product.

Warning



Avoid using a damaged power cord or plug or a loose power outlet.

- Otherwise, it may result in electric shock or fire.

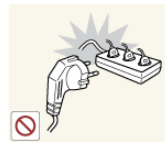

Avoid connecting multiple electric appliances to a single wall outlet.

- Otherwise, it may result in fire due to overheating of the wall outlet.



Avoid plugging in or unplugging the power supply with wet hands.

- Otherwise, it may result in electric shock.

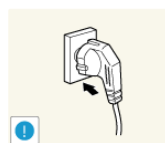

Plug the power plug in firmly.

- Otherwise, it may result in fire.

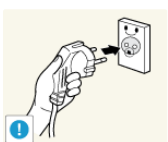

Make sure to connect the power cord to a grounded wall outlet (for insulation class 1 equipment only).

- Otherwise, it may result in electric shock or injury.



Avoid bending or twisting the power cord excessively and avoid placing heavy objects on the cord.

- Otherwise, it may result in electric shock or fire due to a damaged power cord.

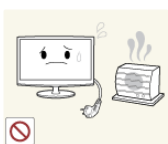

Keep the power cord and the product away from a heater.

- Otherwise, it may result in electric shock or fire.



If the pins of the power plug or the wall outlet are covered in dust, clean it using a dry cloth.

- Otherwise, it may result in fire.

Caution

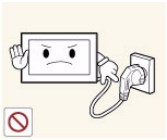

Avoid unplugging the power plug while the product is operating.

- Otherwise, it may damage the product due to electric shock.

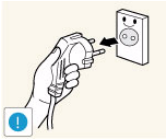

When unplugging the power plug from the wall outlet, make sure to hold it by the plug and not by the cord.

- Otherwise, it may result in electric shock or fire.

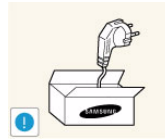

Make sure to use only the power cord supplied by our company. In addition, do not use the power cord of another electric appliance.

- Otherwise, it may result in electric shock or fire.

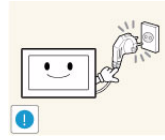

Connect the power plug to a wall outlet that can be easily reached.

- When a problem occurs with the product, you must unplug the power plug to cut the power off completely. You cannot cut the power off completely using only the power button on the product.

Installation Related

Warning



Avoid placing burning candles, mosquito-repellent or cigarettes on the product and installing the product near a heater.

- Otherwise, it may result in fire.



Avoid installing the product in a badly-ventilated location such as inside a bookshelf or closet.

- Otherwise, it may result in fire due to internal over-heating.



Keep the plastic bags used to pack the product away from children.

- If children place the plastic bags over their heads, they may suffocate.



Ask an installation engineer or relevant company to install the product onto the wall.

- Otherwise, it may result in injury.
- Make sure to use the specified wall mount.

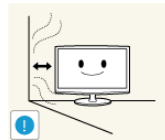

Keep a distance of at least 10 cm from the wall when installing the product for ventilation.

- Otherwise, it may result in fire due to internal over-heating.



Avoid installing the product in a location that is unstable or exposed to excessive vibrations such as on an unstable or slanted shelf.

- The product may fall and this may result in damage to the product or injury.
- If you use the product in a location exposed to excessive vibrations, it may result in a problem with the product or fire.



Avoid installing the product in a location exposed to dust, moisture (sauna), oil, smoke or water (rain drops) and installing it within a vehicle.

- This may result in electric shock or fire.

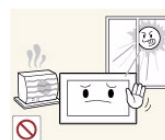

Avoid installing the product in a location exposed to direct sunlight and installing the product near a heat source such as a fire or heater.

- This may shorten the product life cycle or cause fire.



Avoid installing the product at an easily reachable height where children may reach it.

- If a child touches the product, the product may fall and this may result in injury.

- Since the front part is heavier, install the product on a flat and stable surface.

Caution



Do not let the product drop while moving it.

- This may result in a problem with the product or injury.



When installing the product on a console or shelf, make sure that the front of the product does not protrude out of the console or shelf.

- Otherwise, this may cause the product to fall off and result in a malfunction or injury.
- Make sure to use a cabinet or shelf suitable to the size of the product.



If the product is installed in a location where the operating conditions vary considerably, a serious quality problem may occur due to the surrounding environment. In this case, install the product only after consulting one of our service engineers about the matter.

- Places exposed to microscopic dust, chemicals, too high or low temperature, high humidity, such as airports or stations where the product is continuously used for a long time and so on.

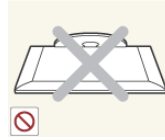

Do not place the product face down on the floor.

- This may damage the panel of the product.



When putting the product down, handle it gently.

- Otherwise, it may result in a problem with the product or injury.

Usage Related

Warning



Since a high voltage runs through the product, never disassemble, repair or modify the product yourself.

- Otherwise, it may result in fire or electric shock.
- If the product needs to be fixed, contact a service center.



When cleaning the product, do not spray water directly over the product parts.

- Make sure that water does not enter the product.
- Otherwise, it may result in fire, electric shock or a problem with the product.



If the product generates a strange noise, a burning smell, or smoke, unplug the power plug immediately and contact a service center.

- Otherwise, it may result in electric shock or fire.



Avoid letting children to hang or climb onto the product.

- Otherwise, it may result in the product falling and this may result in injury or death.



If you drop the product or the case is damaged, turn the power off and unplug the power cord. Contact a service center.

- Otherwise, it may result in fire or electric shock.



Avoid placing objects such as toys and cookies on top of the product.

- If a child hangs over the product to grab an object, the object or the product may fall and this may result in injury or even death.

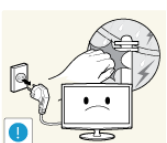

When thunder or lightning occurs, unplug the power cord and under no circumstance touch the antenna cable as this is dangerous.

- Otherwise, it may result in electric shock or fire.

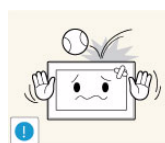

Avoid dropping an object over the product or cause impact to the product.

- Otherwise, it may result in electric shock or fire.



Avoid moving the product by pulling the power cord or antenna cable.

- Otherwise, it may result in electric shock, fire or a problem with the product due to damage to the cable.

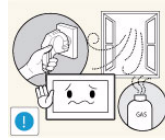

When a gas leak occurs, do not touch the product or the power plug and ventilate immediately.

- A spark may result in an explosion or fire.
- During a thunder or lightning storm, do not touch the power cord or antenna cable.

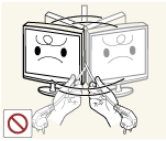

Avoid lifting up or move the product by holding only the power cord or signal cable.

- Otherwise, it may result in electric shock, fire or a problem with the product due to damage to the cable.

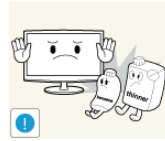

Avoid using or placing inflammable spray or objects near the product.

- This may result in an explosion or fire.



Take care not to block the vent by a table cloth or curtain.

- Otherwise, it may result in fire due to internal overheating.

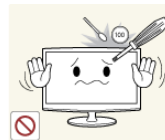

Avoid inserting metal objects such as a chopsticks, coins or hairpins, or inflammable objects into the product (the vents, ports, etc).

- If water or an alien substance enters the product, turn the power off, unplug the power cord and contact a service center.
- Otherwise, it may result in a problem with the product, electric shock or fire.



Avoid placing a liquid container such as a vase, flowerpot, beverage, cosmetics or drugs, or a metal object over the product.

- If water or an alien substance enters the product, turn the power off, unplug the power cord and contact a service center.
- Otherwise, it may result in a problem with the product, electric shock or fire.

Caution

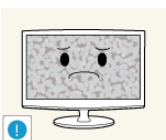

Displaying a still image for a long time may create a persistent image or stain on the screen.

- If you do not use the product for a long time, use the power-saving mode or set the screensaver to the moving picture mode.

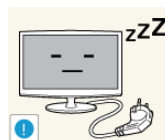

When not using the product for a long time such as leaving your home, unplug the power cord from the wall outlet.

- Otherwise, it may cause dust accumulation and result in fire caused by overheating or short circuit or result in an electric shock.



Set the appropriate resolution and frequency for the product.

- Otherwise, it may result in eye strain.

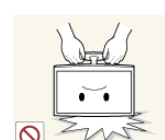

Avoid turning the product upside down or move the product holding only the stand.

- This may cause the product to fall resulting in damage to the product or injury.



Do not place the adapter on top of another adapter.

- Otherwise, it may result in fire.



Keep power adaptor away from any other heat source.

- Otherwise, it may result in fire.



Remove the vinyl cover of the adapter before using the adaptor.

- Otherwise, it may result in fire.

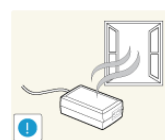

Always keep power adaptor in well-ventilated area.



Be careful that adaptor should not be in contact with water and therefore not be wet.

- This may cause a malfunction, electric shock or fire. Do not use adaptor by the waterside or outside particularly when it rains or snows. Be careful that adaptor should not be wet while cleaning floor with water.

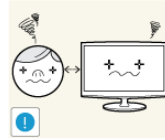

Watching the product from too close a distance continuously may damage your eyesight.



Avoid using a humidifier or cooker near the product.

- Otherwise, it may result in electric shock or fire.

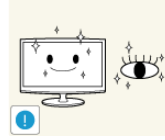

It is important to give your eyes some rest (5 minutes every hour) when viewing the product screen for long periods of time.

- This will alleviate any eye strain.

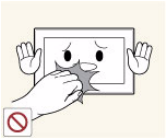

Since the display panel is hot after using it for a long time, do not touch the product.

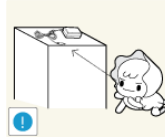

Keep small accessories away from the children.



Take care when adjusting the angle of the product or the height of the stand.

- If your hand or finger is caught, you may be injured.
- If the product is tilted excessively, the product may fall and this may result in injury.



Avoid placing a heavy object over the product.

- Otherwise, it may result in a problem with the product or injury.

Maintaining the Correct Posture when Using this Product

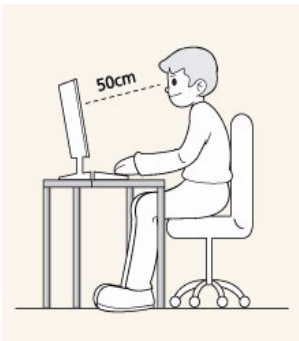

Maintain the correct posture when using this product.

- Straighten your back.
- Keep a distance of 45~50 cm from your eyes to the screen. Look down at the screen and face the screen forwards.
- Adjust the angle of the product so that light is not reflected onto the screen.
- Keep your elbow at a right angle and keep your arm level with the back of your hand.
- Keep your elbow at a right angle.
- Place your heels flat on the ground while keeping your knees at an angle of 90 degrees or higher and maintain the position of your arm so that your arm is below your heart.









2 Installing the Product

2-1 Package Contents

- Unpack the product and check if all of the following contents have been included.
- Store the packaging box in case you need to move the Product at a later stage.



Monitor

Contents			
			
Installation Manual	Product Warranty (Not available in all locations)	User Manual	DC-Adapter
			
Stand	Power Cord		
OPTION			
			
D-Sub Cable	DVI Cable		

- The cables provided may vary depending on the product you purchase.

2-2 Installing the Stand

Before assembling the product, place the product down on a flat and stable surface so that the screen is facing downwards.

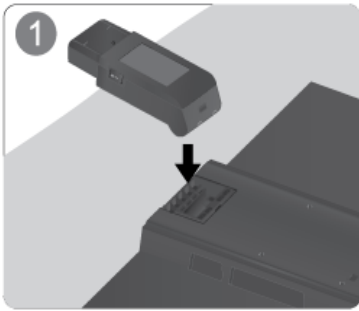

insert the adapter into the head of monitor,when you head a sound "click" then you had fixed the stand-body completely



when insert the ADAPTER,one hand hold it and another hand press the head as picture showing

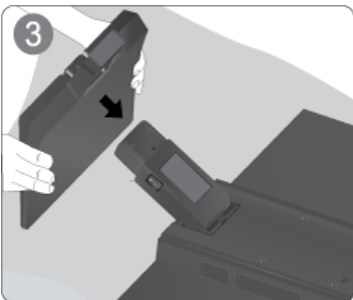

push the stand-base into the stand-body following the arrow as shown,when you head a sound "click" then you had fixed the stand-base completely

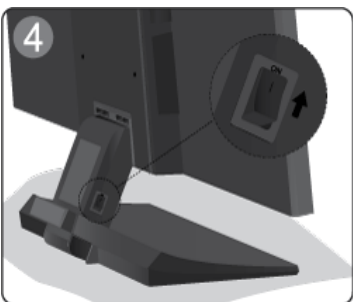

Verify that the connector switch is in "ON" position.

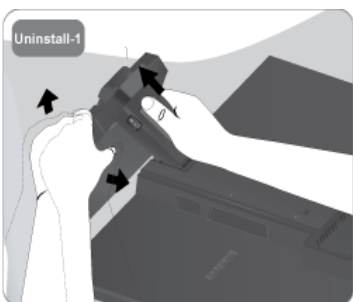

one hand hold the adapter and thumbs press the base following the direction as arrow showing, at the same time another hand shake the base to take it out

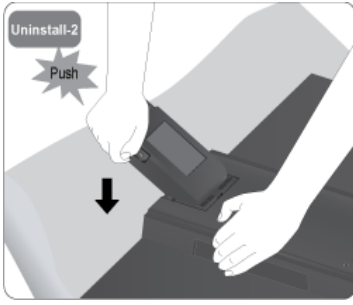

press the adapter hard following the arrow to take it out



please don't hold the monitor up down

 Disassembly is in the reverse order of the assembly.

2-3 Installing the Stand for the Wall Mount

This product provides a stand mount of 100 mm x 100 mm(3.9 inches x 3.9 inches) that complies with the VESA specifications.

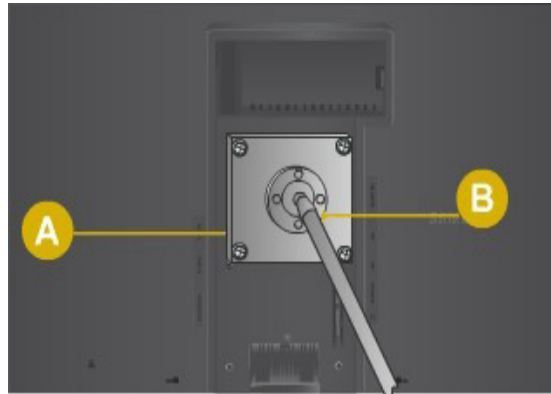

simple stand

A Stand Mount

B Stand (Optional)

1. Turn the product off and unplug the power cord from the wall outlet.
2. Place a soft cloth or cushion on a flat surface to protect the panel and place the product down on the cloth so that the front of the product faces downwards.
3. Separate the stand.
4. Align the groove of the part of the product that is to be connected to the stand with the groove in the stand (desk-top stand, wall mount stand or another stand) and firmly fix the stand by fastening the screw.

- ! If you use a screw that is longer than the standard specifications, the inside of the product may be damaged.
- For wall mounts that are not compatible with the standard VESA specifications, the length of the screw may differ depending on the corresponding specifications.
- Do not use screws that are incompatible with the standard VESA specifications and do not assemble them using excessive force.
- This may result in damage to the product or injury due to the product falling.
- The company shall not be held liable for any damage or injury.
- The company shall not be held liable for any damage to the product or injury caused by using a stand that is not compatible with the specified specifications or due to an installation not performed by an authorized installation engineer.
- When installing the product using a wall mount, purchase a wall mount that provides at least 10 cm of space from the wall.
- The company shall not be held liable for any problems caused by using a stand that is not compatible with the specified specifications.
- Use the wall mount according to the international specifications.

2-4 Connecting with a PC

 The connecting part may differ depending on the product model.

1. Connect the product to a PC depending on the video output supported by the PC.
 - When the graphics card provides D-Sub (<Analog>) output
 - Connect the [RGB IN] port of the product to the [D-Sub] port of the PC with the D-Sub cable.

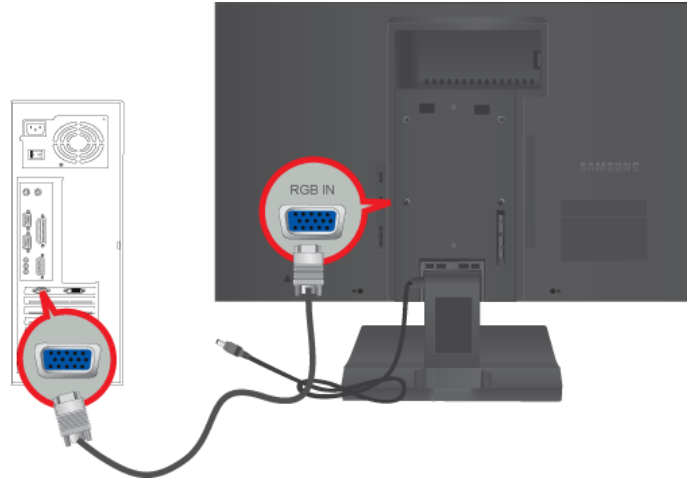

- When the graphics card provides DVI(<Digital>) output
- Connect the [DVI IN] port of the product to the [DVI] port of the PC with the DVI cable.

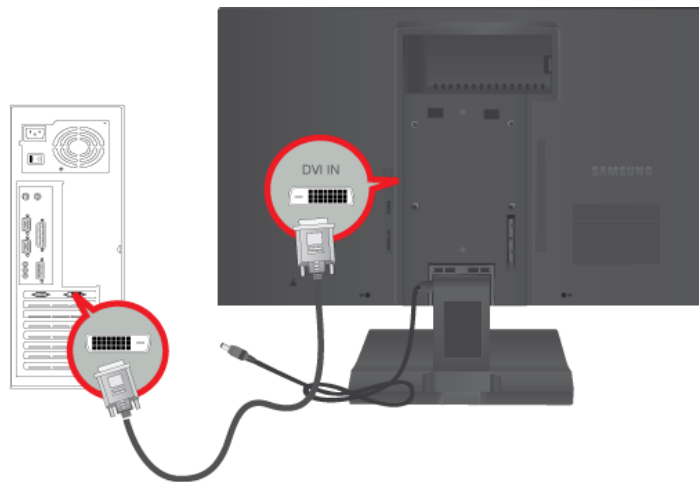

 The [DVI IN] terminal is supplied for the digital (DVI)-dedicated models only.

2. Connect the power adapter to [DC 14V] on the rear of the product. Connect the power cord to the adapter and wall socket.

(The input voltage is switched automatically.)

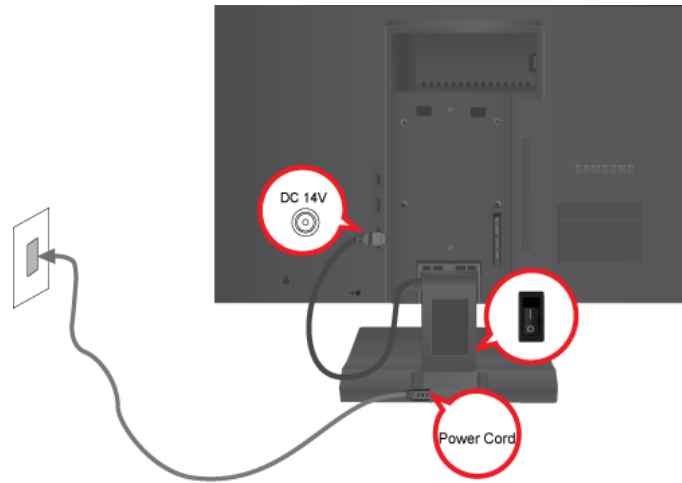

🔌 When the product is connected to a PC, you can turn the product on and use it.

3. Cables can be fixed as shown.



2-5 Kensington Lock

A Kensington Lock is an anti-theft device that enables users to lock the product so that they can safely use it in public locations. Since the shape and usage of the locking device may differ depending on the model and the manufacturer, for more information, refer to the User Manual supplied with the locking device for more information.

 You must purchase the Kensington Lock separately.

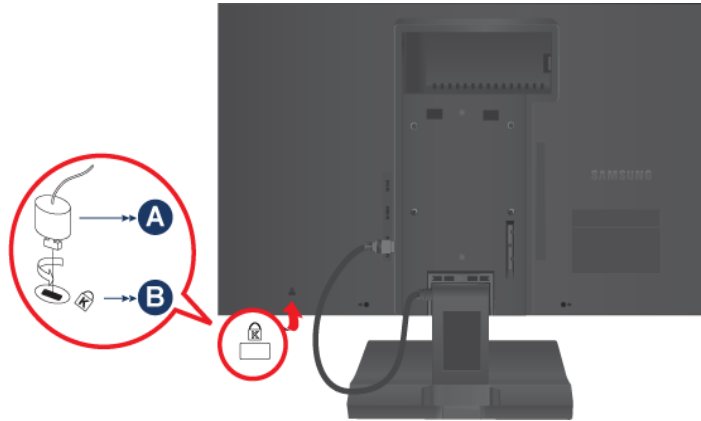

To lock the product, follow these steps:

1. Wrap the Kensington lock cable around a large, stationary object such as a desk or chair.
2. Slide the end of the cable with the lock attached through the looped end of the Kensington lock cable.
3. Insert the locking device into the Kensington slot on the Monitor (**B**).
4. Lock the lock (**A**).

-  • These are general instructions. For exact instructions, see the User Manual supplied with the locking device.
- You can purchase the locking device from an electronics store, an online shop, or our service center.

3 Using the product

3-1 Setting the Optimal Resolution

If you turn the power on after purchasing the product, a message regarding the optimal resolution setting appears on the screen. Select a language and the optimal resolution.

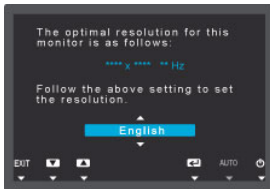

▲/▼ : You can select a language with these buttons.

MENU : If you press this button, the message disappears.

- The message appears up to 3 times if the resolution has not been set to the optimal resolution.
- To set the resolution to the optimal resolution
 - When the PC is turned off, connect the product and the PC and turn the power on.
 - Right-click over the Desktop and select 'Properties' from the pop-up menu.
 - In the 'Settings' tab, set the resolution to the optimal resolution.

3-2 Standard Signal Mode Table

 This product delivers the best picture quality when viewed under the optimal resolution setting. The optimal resolution is dependent on the screen size.

Therefore, the visual quality will be degraded if the optimal resolution is not set for the panel size. It is recommended setting the resolution to the optimal resolution of the product.

If the signal from the PC is one of the following standard signal modes, the screen is set automatically. However, if the signal from the PC is not one of the following signal modes, a blank screen may be displayed or only the Power LED may be turned on. Therefore, configure it as follows referring to the User Manual of the graphics card.

S19A200BW

DISPLAY MODE	HORIZONTAL FREQUENCY (KHZ)	VERTICAL FREQUENCY (HZ)	PIXEL CLOCK (MHZ)	SYNC POLARITY (H/V)
IBM, 640 x 350	31.469	70.086	25.175	+/-
IBM, 720 X 400	31.469	70.087	28.322	-/+
VESA, 640 x 480	31.469	59.940	25.175	-/-
MAC, 640 x 480	35.000	66.667	30.240	-/-
VESA, 640 x 480	37.861	72.809	31.500	-/-
VESA, 640 x 480	37.500	75.000	31.500	-/-
VESA, 800 x 600	35.156	56.250	36.000	+/+
VESA, 800 x 600	37.879	60.317	40.000	+/+
VESA, 800 x 600	48.077	72.188	50.000	+/+
VESA, 800 x 600	46.875	75.000	49.500	+/+
MAC, 832 x 624	49.726	74.551	57.284	-/-
VESA, 1024 x 768	48.363	60.004	65.000	-/-
VESA, 1024 x 768	56.476	70.069	75.000	-/-
VESA, 1024 x 768	60.023	75.029	78.750	+/+
VESA, 1152 x 864	67.500	75.000	108.000	+/+
MAC, 1152 x 870	68.681	75.062	100.000	-/-
VESA, 1280 x 800	49.702	59.810	83.500	-/+
VESA, 1280 x 800	62.795	74.934	106.500	-/+
VESA, 1280 x 960	60.000	60.000	108.000	+/+
VESA, 1280 x 1024	63.981	60.020	108.000	+/+
VESA, 1280 x 1024	79.976	75.025	135.000	+/+
VESA, 1440 x 900	55.935	59.887	106.500	-/+
VESA, 1440 x 900	70.635	74.984	136.750	-/+

Horizontal Frequency

The time taken to scan one line from the left-most position to the right-most position on the screen is called the horizontal cycle and the reciprocal of the horizontal cycle is called the horizontal frequency. The horizontal frequency is represented in kHz.

Vertical Frequency

A panel must display the same picture on the screen tens of times every second so that humans can see the picture. This frequency is called the vertical frequency. The vertical frequency is represented in Hz.

3-3 Installing the Device Driver

❏ If you install the device driver, you can set up the appropriate resolution and frequency for the product. The device driver is included on the CD-ROM supplied with the product. If the supplied drive file is corrupted, please visit a service center or Samsung Electronics website(<http://www.samsung.com/>), and download the driver.

1. Insert the driver installation CD-ROM into the CD-ROM drive.
2. Click on "Windows Driver".
3. Complete the remaining installation steps according to the instructions displayed on the screen.
4. Select the model of your product from the model list.

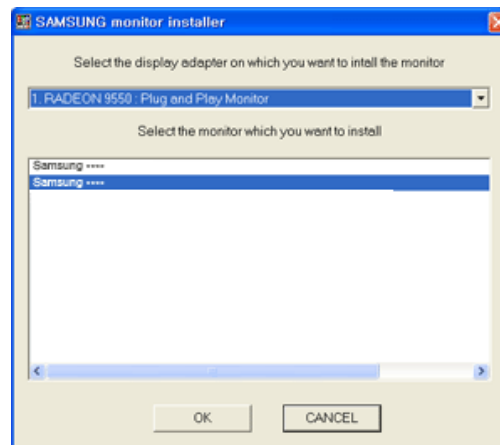







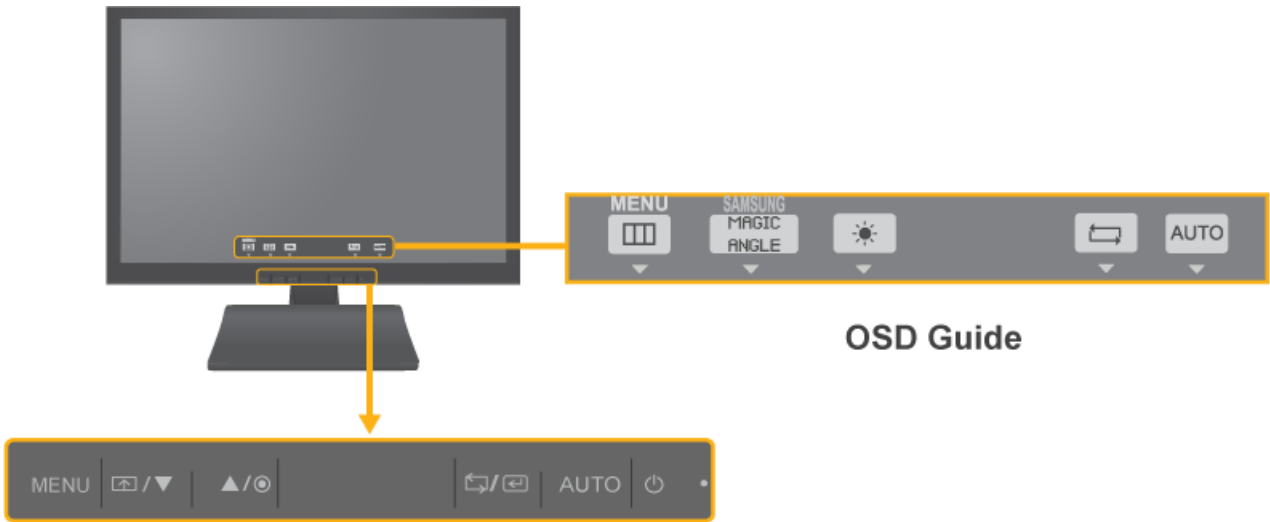

5. Check if the appropriate resolution and screen refresh rate are displayed in the Control Panel settings. For more information, refer to the document about the Windows operating system.







3-4 Product Operating Buttons

Product Operating Buttons



- Press one of the buttons on the monitor. OSD Guide will appear on the screen.
- If you press a button on the front of the monitor, an OSD Guide will display showing the function of the button before the menu for the pressed button appears.
- To go to the menu, press the button on the front of the monitor again.
- OSD Guide may vary according to functions and models. Please refer to actual product.

ICON	DESCRIPTION
<p>MENU</p>	<p>Press this button to view the On Screen Display (OSD).</p> <p>This button is also used to exit the OSD or to return to a higher-level OSD menu</p> <p>* OSD Adjustment Lock</p> <p>This function locks the OSD in order to maintain the current settings or to prevent the settings from being changed by another person</p> <p>On: If you press and hold the MENU button down for 5 seconds, the OSD Adjustment Lock function is activated.</p> <p>Off: If you press and hold the MENU button down for 5 seconds again, the OSD Adjustment Lock function is disabled.</p> <p> Even if the OSD Adjustment Lock function is activated, users can adjust the brightness and contrast and can set up the adjustment function assigned to the .</p>
<p></p>	<p>Users can set the <Customized Key> to one of the following functions. If the user presses the Customized Key  after setting it, the configured function will be performed</p> <ul style="list-style-type: none"> • <  Angle > - <  Bright > - <Eco Saving> - <Image Size> <p> You can set the function of the Customized Key by selecting <SETUP&RESET > -> <Customized Key> in the OSD.</p>
<p>▲/▼</p>	<p>Use these buttons to navigate the menu or to adjust a value in the OSD.</p>
<p></p>	<p>Use this button to control the brightness of the screen.</p>

ICON	DESCRIPTION
	<p>Use this button to select a function.</p> <p>If you press the [] button when there is no OSD, the input signal (Analog/Digital) is switched. When the input signal is switched by pressing [] button or the product is turned on, a message displaying the selected input signal appears at the top left of the screen.</p> <p> This function is not available for products with an Analog interface only.</p>
<p>AUTO</p>	<p>Press [AUTO] button to adjust the screen settings automatically</p> <p> This function is only available in Analog mode.</p> <p>If the resolution settings are changed in the Display Properties, the AUTO adjustment function is performed.</p>
	<p>Press this button to turn the product on or off</p> <p>Power LED</p> <p>This LED is turned on when the product works normally.</p> <p> For more information on the power-saving function, refer to the power saving function in More Information. When not using the product for a long time, unplugging the power cord is recommended to minimize power consumption.</p>

3-5 Using the Screen Adjustment Menu (OSD: On Screen Display)

The Screen Adjustment Menu (OSD: On Screen Display) Structure



Top Menu	Sub Menus				
PICTURE	Brightness	Contrast	Sharpness	SAMSUNG MAGIC Bright	SAMSUNG MAGIC Angle
	Coarse	Fine			
COLOR	SAMSUNG MAGIC Color	Red	Green	Blue	Color Tone
	Gamma				
SIZE & POSITION	H-Position	V-Position	Image Size	Menu H-Position	Menu V-Position
SETUP&RESET	Reset	Language	Eco Saving	Off Timer On/Off	Off Timer Setting
	PC/AV Mode	Key Repeat Time	Customized Key	Auto Source	Display Time
	Menu Transparency				
INFORMATION					













Monitor functions may vary according to models. Please refer to actual product.

PICTURE



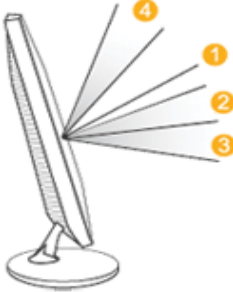
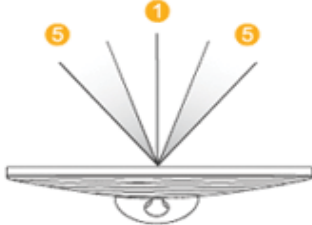





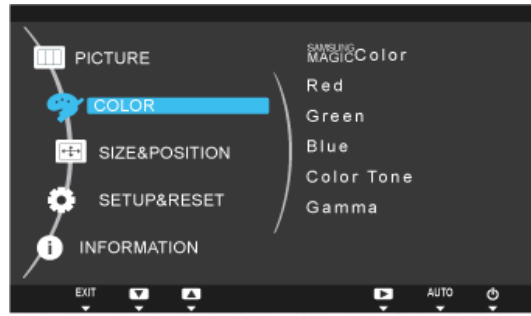

Menu	Description
Brightness	<p>Controls the screen brightness.</p> <ul style="list-style-type: none"> This menu is unavailable when <SAMSUNG MAGIC Bright> is set to <Dynamic Contrast> mode. This menu is unavailable when <Eco Saving> is set.
Contrast	<p>Controls the contrast of the pictures displayed on the screen</p> <ul style="list-style-type: none"> This menu is unavailable when <SAMSUNG MAGIC Bright> is set to <Dynamic Contrast> or <Cinema> mode. This menu is unavailable when <SAMSUNG MAGIC Color> is set to <Full> mode or <Intelligent> mode.

Menu	Description
Sharpness	<p>Controls the clarity of details of pictures displayed on the screen</p> <ul style="list-style-type: none">  <ul style="list-style-type: none"> • This menu is unavailable when <SAMSUNG MAGIC Bright> is set to <Dynamic Contrast> or <Cinema> mode. • This menu is unavailable when <SAMSUNG MAGIC Color> is set to <Full> mode or <Intelligent> mode.
SAMSUNG MAGIC Bright	<p>Provides preset picture settings optimized for various user environments such as editing a document, surfing the Internet, playing games, or movies and so on.</p> <ul style="list-style-type: none"> • <Custom> <p>If the preset picture modes are not sufficient, users can configure the <brightness> and <Contrast> directly using this mode.</p> <ul style="list-style-type: none"> • <Standard> <p>This mode provides the picture setting appropriate for editing a document and surfing the Internet (text + picture).</p> <ul style="list-style-type: none"> • <Game> <p>This mode provides the picture setting appropriate for playing games that include lots of graphics and that require a fast screen refresh rate.</p> <ul style="list-style-type: none"> • <Cinema> <p>This mode provides brightness and sharpness settings similar to those of a TV for the best entertainment environment (movie, DVD, etc.).</p> <ul style="list-style-type: none"> • <Dynamic Contrast> <p>Controls the picture contrast automatically so that bright and dark pictures are balanced overall.</p> <ul style="list-style-type: none">  <ul style="list-style-type: none"> • This menu is unavailable when <SAMSUNG MAGIC Angle> or <Eco Saving> is set.

Menu	Description
SAMSUNG MAGIC Angle	<p>This feature allows you to see optimal screen quality according to your viewing position.</p> <p>When viewing the screen at an angle from below, above or the side of the monitor, by setting the appropriate mode for each position you can obtain a similar picture quality as viewing the screen directly from the front.</p> <p> Set to <Off> when viewing directly in front of the screen.</p> <ul style="list-style-type: none"> • <Off>  - Select when viewing from the front position. • <Lean Back Mode1>  - Select when viewing from a slightly lower position. • <Lean Back Mode2>  - Select when viewing from the lower position. • <Standing Mode>  -Select when viewing from the upper position. • <Side Mode>  - Select when viewing from the left or right position. • <Group View> - Select when two or more persons view among , ,  position at the same time. • <Custom> -When <Custom> is selected, settings for <Lean Back Mode 1> is applied by default. Users can set suitable picture quality as needed. <div style="display: flex; justify-content: space-around; align-items: center;">   </div> <p> • This menu is unavailable when <SAMSUNG MAGIC Bright> is set to <Dynamic Contrast> or <Cinema> mode.</p> <p>• This menu is unavailable when <SAMSUNG MAGIC Color> is set.</p>
Coarse	<p>Removes vertical noise lines (line pattern) from the screen.</p> <p>The location of the screen may be changed after the adjustment. In this case, move the screen so that the screen is displayed at the center of the display panel using the <H-Position> menu.</p> <p> This function is only available in Analog mode.</p>
Fine	<p>Removes horizontal noise lines (line pattern) from the screen.</p> <p>If you cannot remove the noise completely with the <Fine> function, adjust the <Coarse> and then use the <Fine> function again.</p> <p> This function is only available in Analog mode.</p>







Menu	Description
SAMSUNG MAGIC Color	Expresses natural colors more clearly without changing the picture quality using proprietary digital picture quality improvement technology developed by Samsung Electronics. <ul style="list-style-type: none"> • <Off> - Turns the <SAMSUNG MAGICColor> function off. • <Demo> - You can compare the pictures processed by <SAMSUNG MAGICColor> with the original pictures. • <Full> - Provides a clearer picture including areas corresponding to skin color. • <Intelligent> - Improves the chroma of pictures except for areas corresponding to skin color. <p> This menu is unavailable when <SAMSUNG MAGICAngle> is set.</p>
Red	You can adjust the red color value of pictures according to your preference. <p> This menu is unavailable when <SAMSUNG MAGICColor> is set to <Full> mode or <Intelligent> mode.</p>
Green	You can adjust the green color value of pictures according to your preference. <p> This menu is unavailable when <SAMSUNG MAGICColor> is set to <Full> mode or <Intelligent> mode.</p>
Blue	You can adjust the blue color value of pictures according to your preference. <p> This menu is unavailable when <SAMSUNG MAGICColor> is set to <Full> mode or <Intelligent> mode.</p>
Color Tone	You can set the color temperature according to your preference. <ul style="list-style-type: none"> • <Cool 2> - Sets the color temperature of the screen to very cool. • <Cool 1>- Sets the color temperature of the screen to cool. • <Normal> - Sets the color temperature of the screen to the standard color temperature. • <Warm 1> - Sets the color temperature of the screen to warm. • <Warm 2> - Sets the color temperature of the screen to very warm. • <Custom> - Select this menu to set the color temperature manually. If you do not like the preset color temperatures, you can manually adjust the value of RGB. <p> • This menu is unavailable when <SAMSUNG MAGICColor> is set to <Full> mode or <Intelligent> mode.</p> <p> • This menu is unavailable when <SAMSUNG MAGICAngle> is set.</p>
Gamma	Using this menu, you can change the intensity of the colors of medium brightness. <ul style="list-style-type: none"> • <Mode1> - <Mode2> - <Mode3> <p> This menu is unavailable when <SAMSUNG MAGICAngle> is set.</p>

 (This is unavailable when <SAMSUNG MAGIC Bright> is set to <Dynamic Contrast> and <Cinema> mode.)





SIZE & POSITION

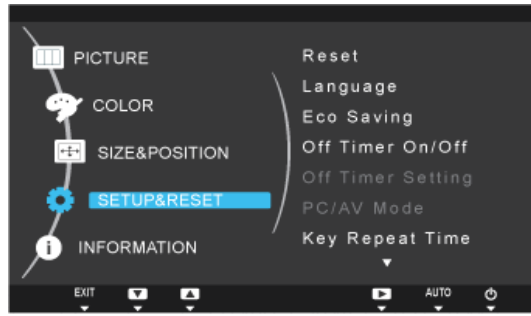

Menu	Description
H-Position	<p>Moves the position of the display area on the screen horizontally.</p> <ul style="list-style-type: none">  This function is only available in Analog mode. When a 720P, 1080i or 1080P signal is input in AV mode ,select <Screen Fit >to adjust horizontal position in 0-6 levels.
V-Position	<p>Moves the position of the display area on the screen vertically.</p> <ul style="list-style-type: none">  This function is only available in Analog mode. When a 720P, 1080i or 1080P signal is input in AV mode ,select <Screen Fit >to adjust vertical position in 0-6 levels.
Image Size	<ul style="list-style-type: none">  Supplied for the wide models only such as 16:9 or 16:10. <p>PC signals</p> <ul style="list-style-type: none"> <Auto> - The picture is displayed at the aspect ratio of the input signal. <Wide> - The picture is displayed in full screen regardless of the aspect ratio of the input signal. <ul style="list-style-type: none">  A signal not in the standard mode table is not supported. If the resolution is set to the optimal resolution, the aspect ratio does not change whether the <Image Size> is set to <Auto> or <Wide>. <p>AV signals</p> <ul style="list-style-type: none"> <4 : 3> - Displays pictures at the 4:3 aspect ratio. <16 : 9> - Displays pictures at the 16:9 aspect ratio. <Screen Fit> - If a 720P, 1080i or 1080P signal is input in DVI input mode, the picture is displayed as is without truncation. <ul style="list-style-type: none">  This can only be set when the external input is connected through DVI and <PC/AV Mode> is set to <AV>.
Menu H-Position	You can adjust the horizontal position of the OSD.
Menu V-Position	You can adjust the vertical position of the OSD.

⚙️ SETUP&RESET



Menu	Description
Reset	<p>Use this function to restore the visual quality and color settings to the factory defaults.</p> <ul style="list-style-type: none"> • <Yes> - <No> 
Language	<p>Select a language for the OSD.</p> <ul style="list-style-type: none"> • Deutsch, English, Español, Français, Italiano, Magyar, Polski, Português, Русский, Svenska, Türkçe, 日本語, 한국어, 汉语 <p> The selected language is only applied to the product OSD. This setting does not affect the other functions of the PC.</p>
Eco Saving	<p>This function provides user a low power mode which is realized by lowering the current of the display panel.</p> <ul style="list-style-type: none"> • <75%> When <75%> is selected, the power consumption is about 75% of default setting. • <50%> When <50%> is selected, the power consumption is about 50% of default setting. • <Off> When <Off> is selected, the function is turned Off . <p> This menu is unavailable when <SAMSUNG MAGIC Bright> is set to <Dynamic Contrast> mode.</p>
Off Timer On/Off	<p>You can turn the Off Timer on or off.</p> <ul style="list-style-type: none"> • <Off> - <On>
Off Timer Setting	<p>Turns the power off automatically when the configured time is reached.</p> <p> When <On> of <Off Timer On/Off> is selected, This function is available only.</p>

Menu	Description
PC/AV Mode	<p>Set to PC when connected to a PC. Set to AV when connected to an AV device.</p> <ul style="list-style-type: none"> • This function does not support Analog mode. • Supplied for the wide models only such as 16:9 or 16:10. • If the monitor (when set to Digital) is in power saving mode or is displaying the message <Check Signal Cable>, press the MENU button to display the On Screen Display (OSD). You can select <PC> or <AV>.
Key Repeat Time	<p>Controls the repeat delay of a button. You can set to <Acceleration>, <1 sec> or <2 sec>. If <No Repeat> is selected, the button only responds once.</p>
Customized Key	<p>You can set the function of the Customized Key to one of the following.</p> <ul style="list-style-type: none"> • <SAMSUNG MAGIC Angle> - <SAMSUNG MAGIC Bright> - <Eco Saving> - <Image Size>
Auto Source	<ul style="list-style-type: none"> • <Auto> - The monitor automatically selects an input signal. • <Manual> - Users have to manually select an input signal. <p>Not applicable to analog (D-SUB)-or-digital (DVI)-dedicated models.</p>
Display Time	<p>The OSD automatically disappears if no action is taken by the user. You can determine the time to wait before the OSD is hidden.</p> <ul style="list-style-type: none"> • <5 sec> - <10 sec> - <20 sec> - <200 sec>
Menu Transparency	<p>You can select the transparency of the OSD.</p> <ul style="list-style-type: none"> • <Off> - <On>

i INFORMATION



Menu	Description
INFORMATION	<p>Shows the frequency and resolution set on the PC.</p> <ul style="list-style-type: none"> • For models with an Analog interface only, <Analog/Digital> is not shown in the <Information>.

4 Installing the Software

4-1 Natural Color

What is Natural Color ?

This software works only for Samsung products and enables adjusting the displayed colors on the product and matches the colors on the product with the colors of the printed pictures. For more information, refer to the online help of the software (F1).

The Natural Color is provided online. You can download it from the website below and install;

http://www.samsung.com/us/consumer/learningresources/monitor/naturalcolorexpert/pop_download.html



What is MagicTune?



MagicTune is a software program that helps with monitor adjustments by providing comprehensive descriptions of monitor functions and easy-to-understand guidelines.

Users can adjust the product with the mouse and the keyboard without using the operating buttons of the product.

Installing the Software

1. Insert the installation CD into the CD-ROM drive.
2. Select the MagicTune setup program.
 -  If the pop-up screen for the software installation does not appear on the main screen, find and double-click the MagicTune setup file on the CD-ROM.
3. Select the installation language and click [Next].
4. Complete the remaining software installation steps according to the instructions displayed on the screen.
 - 
 - The software may not work properly if you do not restart the computer after the installation.
 - The MagicTune icon may not appear depending on the computer system and the product specifications.
 - If the shortcut icon does not appear, press the F5 key.

Restrictions and Problems with the Installation (MagicTune™)

The installation of MagicTune™ may be affected by the graphics card, motherboard and the networking environment.

System Requirements

OS

- Windows 2000
- Windows XP Home Edition
- Windows XP Professional
- Windows Vista 32Bit
- Windows 7 32Bit

 For MagicTune™, Windows 2000 or later is recommended.

Hardware

- At least 32MB of memory
- At least 60MB of free space on the hard disk drive

 For more information, refer to the website.

Removing the Software

You can only remove MagicTune™ through [Add or Remove Programs] in Windows.

To remove MagicTune™, complete the following steps.

1. Click [Start], select [Settings], and select [Control Panel] from the menu.
For Windows XP, click [Start], and select [Control Panel] from the menu.
2. Double-click the [Add or Remove Programs] icon in the Control Panel.



3. In the [Add/Remove] window, find and select MagicTune™ so that it is highlighted.
 4. Click [Change or Remove Programs] to remove the software.
 5. Select [Yes] to start removing MagicTune™.
 6. Wait until a message box appears informing you that the software has been removed completely.
- For technical support, the FAQ (frequently asked questions) or information about the software upgrade for MagicTune™, please visit our website.
 - MagicTune does not be compatible with all video cards. For better woking, Win7 OS is recommended.
 - Before using MagicTune, we suggest that video card driver should be updated as latest version.

What is MultiScreen ?



MultiScreen enables users to use the monitor by partitioning multiple sections.

Installing the Software

1. Insert the installation CD into the CD-ROM drive.
2. Select the MultiScreen setup program.
 -  If the pop-up screen for the software installation does not appear on the main screen, find and double-click the MultiScreen setup file on the CD-ROM.
3. When the Installation Wizard appears, click [Next].
4. Complete the remaining software installation steps according to the instructions displayed on the screen.
 - 
 - The software may not work properly if you do not restart the computer after the installation.
 - The MultiScreen icon may not appear depending on the computer system and the product specifications.
 - If the shortcut icon does not appear, press the F5 key.

Restrictions and Problems with the Installation (MultiScreen)

The MultiScreen installation may be affected by the graphics card, motherboard and the networking environment.

Operating System

OS

- Windows 2000
- Windows XP Home Edition
- Windows XP Professional
- Windows Vista 32Bit
- Windows 7 32Bit

 For MultiScreen, the operating systems Windows 2000 or later is recommended.

Hardware

- At least 32MB of memory
- At least 60MB of free space on the hard disk drive

Removing the Software

Click [Start], select [Settings]/[Control Panel], and then double-click [Add or Remove Programs].

Select MultiScreen from the program list and click the [Add/Delete] button.



5 Troubleshooting

5-1 Monitor Self-Diagnosis

- You can check if the product is working properly using the Self-Diagnosis function.
 - If a blank screen is displayed and the Power LED blinks even if the product and the PC are properly connected, perform the self-diagnosis function according to the procedures below.
1. Turn the product and the PC off.
 2. Separate the signal cable from the product .
 3. Turn the product on.
 4. If the product is working properly, the <Check Signal Cable> message appears.
In this case, if a blank screen is displayed again, make sure that there is no problem with the PC and the connection. The product is working properly.

5-2 Before Requesting Service

-  Please check the following before requesting After-Sales service. If the problem continues, please contact your nearest Samsung Electronics Service Center.

A blank screen appears / I cannot turn the product on	
Is the power cord connected properly?	Check the connection status of the power cord.
Is the <Check Signal Cable> message displayed on the screen?	(Connected using the D-sub cable) Check the cable connecting the PC and the product. (Connected using the DVI cable) If the message appears on the screen even if the cable is properly connected, recheck the input signal by pressing the [] button of the product.
Is the <Not Optimum Mode> message displayed on the screen?	This occurs when the signal from the graphics card exceeds the maximum resolution or the maximum frequency of the product. In this case, set up the appropriate resolution and the frequency for the product.
Is a blank screen displayed and does the power LED blink at a 1 second interval?	<ol style="list-style-type: none"> 1. This occurs when the power saving function is running. If you click the mouse or press any key, the screen will be turned on. 2. If the "Check Signal Cable" condition persists for more than five minutes, Lossless mode will be activated. In Lossless mode, the backlight of the monitor will turn off.
Did you connect with a DVI cable?	If you connect the DVI cable when the PC has booted up or if you reconnect the DVI cable after disconnecting the cable while using a PC, the screen may not be displayed because some graphics cards do not output the video signal. In this case, reboot the PC while the DVI cable is connected.
THE IMAGE IS TOO LIGHT OR TOO DARK.	
Adjust the <Brightness> and <Contrast>. (Refer to the <Brightness>, <Contrast>)	
The display brightness can differ according to the mode set for <  Angle >.	
If <  Bright > is set to <Dynamic Contrast>, the display brightness can differ according to the input signal.	
The on screen adjustment menu (OSD) does not appear.	
Did you cancel the screen adjustment?	Check if the OSD Adjustment Lock function is set to Off.
The color is weird / The picture is displayed in black and white	
Is the entire screen displayed in the same color as if viewing the screen through a cellophane paper?	Check the cable connection to the computer. Reinsert the graphics card into the computer completely.
Is the graphics card configured correctly?	Set up the graphics card referring to the user manual.
The display area suddenly moves to an edge or to the center.	
Did you change the graphics card or the driver?	Please press the [AUTO] button to run the auto adjustment function.

The display area suddenly moves to an edge or to the center.	
Did you change the resolution and frequency appropriate to the product?	Set the resolution and the frequency to the appropriate values in the graphics card refer to the (Standard Signal Mode Table)
Is the graphics card configured correctly?	Set up the graphics card referring to the user manual.
The pictures are out-of-focus.	
Did you change the resolution and the frequency appropriate to the product?	Set the resolution and the frequency to the appropriate values in the graphics card refer to the (Standard Signal Mode Table)
The color is displayed in 16 bit (16 colors). The color has been changed after changing the graphics card.	
Did you install the device driver for the product?	Windows XP : Set the color again by selecting Control Panel → Appearance and Themes → Display → Settings. Windows ME/2000 : Set the color again by selecting Control Panel → Display → Settings. Windows Vista : Change the color settings by selecting Control Panel → Appearance and Personalization → Personalization → Display settings. Windows 7 : Change the color settings by selecting Control Panel → Appearance and Personalization → Display → Adjust resolution → Advanced settings → Monitor. (For more information, refer to the Windows user manual for the computer.)
Is the graphics card configured correctly?	Configure the color again in accordance with the new graphics card driver.
When I connect the monitor, the 'Unknown monitor, Plug&Play (VESA DDC) monitor found' message is displayed.	
Did you install the device driver for the product?	Install the device driver referring to the descriptions about the driver installation.
Check if all the Plug&Play (VESA DDC) functions are supported referring to the User Manual of the graphics card.	Install the device driver referring to the descriptions about the driver installation.
When I look at the exterior edges of the product, small alien substances appear on it.	
Since this product is designed so that the color has a soft appearance by coating it with a transparent material over the black edges, such things may be seen. This is not a defect of the product.	
A “beep, beep” sound is heard when booting the computer.	
If the beep sound is generated 3 or more times when booting up the computer, please request service for the computer.	

FAQ!	PLEASE TRY THE FOLLOWING!
<p>How can I change the frequency (refresh rate) of the video signal?</p>	<p>You have to change the frequency of the graphics card.</p> <p>Windows XP : Change the frequency by selecting Control Panel → Appearance and Themes → Display → Settings → Advanced → Monitor, and then change the refresh rate under Monitor Settings.</p> <p>Windows ME/2000 : Change the frequency by selecting Control Panel → Display → Settings → Advanced → Monitor, and then change the refresh rate under Monitor Settings.</p> <p>Windows Vista : Change the frequency by selecting Control Panel → Appearance and Personalization → Personalization → Display settings → Advanced settings → Monitor, and then change the refresh rate under Monitor Settings.</p> <p>Windows 7 : Change the frequency by selecting Control Panel → Appearance and Personalization → Display → Adjust resolution → Advanced settings → Monitor, and then change the refresh rate under Monitor Settings.</p> <p>(For more information, refer to the User Manual of the computer or the graphics card.)</p>
<p>How can I change the resolution?</p>	<p>Windows XP : Change the resolution by selecting Control Panel → Appearance and Themes → Display → Settings.</p> <p>Windows ME/2000 : Change the resolution by selecting Control Panel → Display → Settings.</p> <p>Windows Vista : Change the resolution by selecting Control Panel → Appearance and Personalization → Personalization → Display settings.</p> <p>Windows 7 : Change the resolution by selecting Control Panel → Appearance and Personalization → Display → Adjust resolution.</p> <p>(For more information, refer to the User Manual of the computer or the graphics card.)</p>
<p>How can I use the power saving function?</p>	<p>Windows XP : Configure it by selecting Control Panel → Appearance and Themes → Display → Screen Saver Setting or configure it in the BIOS Setup of the computer.</p> <p>Windows ME/2000 : Configure it by selecting Control Panel → Display → Screen Saver Setting or Configure it in the BIOS Setup of the computer.</p> <p>Windows Vista : Change settings by selecting Control Panel → Appearance and Personalization → Personalization → Screen Saver. You can also use the BIOS SETUP menu on the PC.</p> <p>Windows 7 : Change settings by selecting Control Panel → Appearance and Personalization → Personalization → Screen Saver. You can also use the BIOS SETUP menu on the PC.</p> <p>(For more information, refer to the Windows user manual for the computer.)</p>

6 More Information

6-1 Specifications

MODEL NAME		S19A200BW
Panel	Size	19 inches (48 cm)
	Display area	408.24 mm(H) X 255.15 mm(V)
	Pixel Pitch	0.2835 mm (H) x 0.2835 mm (V)
Synchroniza- tion	Horizontal	30 ~ 81 kHz
	Vertical	56 ~ 75 Hz
Display Color		16.7M
Resolution	Optimum resolution	1440 x 900 @ 60Hz
	Maximum resolution	1440 x 900 @ 75Hz
Input Signal, Terminated		RGB Analog, DVI(Digital Visual Interface) Compliant Digital RGB 0.7 Vp-p ± 5% separate H/V sync, Composite, SOG TTL level (V high ≥ 2.0V, V low ≤ 0.8V)
Maximum Pixel Clock		137MHz (Analog,Digital)
Power Supply		This product supports 100-240 V. Since the standard voltage may differ from country to country, please check the label on the back of the product.
Signal Cable		15pin-to-15pin D-sub cable, Detachable DVI-D to DVI-D connector, Detachable
Dimensions (WxHxD) / Weight		443 x 302 x 50 mm (17.4 x 11.9 x 2.0 inches) (Without Stand) 443 x 395 x 201 mm (17.4 x 15.6 x 7.9 inches) (With Stand) / 5.05 kg (11.1 lbs)
VESA Mounting Interface		100 mm x 100 mm / 3.9 inches x 3.9 inches
Environmen- tal consider- ations	Operating	Operating Temperature : 50°F ~ 104°F (10°C ~ 40°C) Humidity : 10 % ~ 80 %, non-condensing
	Storage	Storage Temperature : -4°F ~ 140°F (-20°C ~ 60°C) Humidity : 5 % ~ 95 %, non-condensing
Tilt		-1°(±2°) ~ 21°(±2°)

 Design and specifications are subject to change without prior notice.

 Class B (Information Communication equipment for residential use)

This device is registered for EMC requirements for home use (Class B). It can be used in all areas.

(Class B equipment emits less electromagnetic waves than Class A equipment.)

(USA ONLY)

Dispose unwanted electronics through an approved recycler.

To find the nearest recycling location, go to our website,

www.samsung.com/recyclingdirect, or call (877) 278 - 0799

6-2 Power Saving Function

This monitor has a built-in power management system called PowerSaver. This system saves energy by switching your monitor to low-power mode when it has not been used for a certain amount of time. The monitor automatically returns to normal operation when you press a key on the keyboard. For energy conservation, turn your monitor OFF when it is not needed, or when leaving it unattended for long periods. The PowerSaver system operates with a VESA DPM compliant video card installed in your computer. Use the software utility installed on your computer to set up this feature.

STATE	NORMAL OPERATION	POWER SAVING MODE	POWER OFF
Power Indicator	On	Blinking	Off
Power Consumption	20 watts	Less than 0.3 watts	Less than 0.3 watts

 If there is no power cut-off switch, the power consumption is "0" only when the power cord is disconnected.

6-3 Contact SAMSUNG WORLDWIDE

- If you have any questions or comments relating to Samsung products, please contact the SAMSUNG customer care center.

NORTH AMERICA		
U.S.A	1-800-SAMSUNG (726-7864)	http://www.samsung.com
CANADA	1-800-SAMSUNG (726-7864)	http://www.samsung.com/ca http://www.samsung.com/ca_fr (French)
MEXICO	01-800-SAMSUNG (726-7864)	http://www.samsung.com
LATIN AMERICA		
ARGENTINA	0800-333-3733	http://www.samsung.com
BRAZIL	0800-124-421 4004-0000	http://www.samsung.com
BOLIVIA	800-10-7260	http://www.samsung.com
CHILE	800-SAMSUNG(726-7864) From mobile 02-482 82 00	http://www.samsung.com
COLOMBIA	01-8000112112	http://www.samsung.com
COSTA RICA	0-800-507-7267	http://www.samsung.com
DOMINICA	1-800-751-2676	http://www.samsung.com
ECUADOR	1-800-10-7267	http://www.samsung.com
EL SALVADOR	800-6225	http://www.samsung.com
GUATEMALA	1-800-299-0013	http://www.samsung.com
HONDURAS	800-27919267	http://www.samsung.com
JAMAICA	1-800-234-7267	http://www.samsung.com
NICARAGUA	00-1800-5077267	http://www.samsung.com
PANAMA	800-7267	http://www.samsung.com
PERU	0-800-777-08	http://www.samsung.com
PUERTO RICO	1-800-682-3180	http://www.samsung.com
TRINIDAD & TOBAGO	1-800-SAMSUNG(726-7864)	http://www.samsung.com
VENEZUELA	0-800-100-5303	http://www.samsung.com
EUROPE		
ALBANIA	42 27 5755	http://www.samsung.com
AUSTRIA	0810 - SAMSUNG (7267864, € 0.07/min)	http://www.samsung.com
BELGIUM	02-201-24-18	http://www.samsung.com/be (Dutch) http://www.samsung.com/be_fr (French)
BOSNIA	05 133 1999	http://www.samsung.com
BULGARIA	07001 33 11	http://www.samsung.com
CROATIA	062 SAMSUNG (062 726 7864)	http://www.samsung.com

EUROPE

CZECH	800 - SAMSUNG (800-726786)	http://www.samsung.com
	Samsung Electronics Czech and Slovak, s.r.o., Oasis Florenc, Sokolovská 394/17, 180 00, Praha 8	
DENMARK	70 70 19 70	http://www.samsung.com
FINLAND	030 - 6227 515	http://www.samsung.com
FRANCE	01 48 63 00 00	http://www.samsung.com
GERMANY	01805 - SAMSUNG (726-7864 € 0,14/Min)	http://www.samsung.com
CYPRUS	From landline : 8009 4000	http://www.samsung.com
GREECE	From landline : 80111-SAMSUNG (7267864) From landline & mobile : (+30) 210 6897691	http://www.samsung.com
HUNGARY	06-80-SAMSUNG(726-7864)	http://www.samsung.com
ITALIA	800-SAMSUNG(726-7864)	http://www.samsung.com
KOSOVO	+381 0113216899	http://www.samsung.com
LUXEMBURG	261 03 710	http://www.samsung.com
MACEDONIA	023 207 777	http://www.samsung.com
MONTENEGRO	020 405 888	http://www.samsung.com
NETHERLANDS	0900-SAMSUNG (0900-7267864) (€ 0,10/Min)	http://www.samsung.com
NORWAY	815-56 480	http://www.samsung.com
POLAND	0 801-1SAMSUNG(172-678) +48 22 607-93-33	http://www.samsung.com
PORTUGAL	808 20-SAMSUNG (808 20 7267)	http://www.samsung.com
RUMANIA	From landline : 08010-SAMSUNG (7267864) From landline & mobile : (+40) 21 206 01 10	http://www.samsung.com
SERBIA	0700 Samsung (0700 726 7864)	http://www.samsung.com
SLOVAKIA	0800 - SAMSUNG(0800-726 786)	http://www.samsung.com
SPAIN	902 - 1 - SAMSUNG (902 172 678)	http://www.samsung.com
SWEDEN	0771 726 7864 (SAMSUNG)	http://www.samsung.com
SWITZERLAND	0848 - SAMSUNG (7267864, CHF 0.08/min)	http://www.samsung.com/ch http://www.samsung.com/ch_fr/ (French)
U.K	0330 SAMSUNG (7267864)	http://www.samsung.com
EIRE	0818 717100	http://www.samsung.com
LITHUANIA	8-800-77777	http://www.samsung.com
LATVIA	8000-7267	http://www.samsung.com
ESTONIA	800-7267	http://www.samsung.com
Turkey	444 77 11	http://www.samsung.com

CIS		
RUSSIA	8-800-555-55-55	http://www.samsung.com
GEORGIA	8-800-555-555	http://www.samsung.com
ARMENIA	0-800-05-555	http://www.samsung.com
AZERBAIJAN	088-55-55-555	http://www.samsung.com
KAZAKHSTAN	8-10-800-500-55-500(GSM: 7799)	http://www.samsung.com
UZBEKISTAN	8-10-800-500-55-500	http://www.samsung.com
KYRGYZSTAN	00-800-500-55-500	http://www.samsung.com
TADJIKISTAN	8-10-800-500-55-500	http://www.samsung.com
MONGOLIA		http://www.samsung.com
UKRAINE	0-800-502-000	http://www.samsung.com/ua http://www.samsung.com/ua_ru
BELARUS	810-800-500-55-500	http://www.samsung.com
MOLDOVA	00-800-500-55-500	http://www.samsung.com
ASIA PACIFIC		
AUSTRALIA	1300 362 603	http://www.samsung.com
NEW ZEALAND	0800 SAMSUNG (0800 726 786)	http://www.samsung.com
CHINA	400-810-5858	http://www.samsung.com
HONG KONG	(852) 3698 4698	http://www.samsung.com/hk http://www.samsung.com/hk_en/
INDIA	1800 1100 11 3030 8282 1800 3000 8282 1800 266 8282	http://www.samsung.com
INDONESIA	0800-112-8888 021-5699-7777	http://www.samsung.com
JAPAN	0120-327-527	http://www.samsung.com
MALAYSIA	1800-88-9999	http://www.samsung.com
PHILIPPINES	1-800-10-SAMSUNG(726-7864) for PLDT 1-800-3-SAMSUNG(726-7864)for Digi-tel 1-800-8-SAMSUNG(726-7864) for Globe 02-5805777	http://www.samsung.com
SINGAPORE	1800-SAMSUNG(726-7864)	http://www.samsung.com
THAILAND	1800-29-3232 02-689-3232	http://www.samsung.com
TAIWAN	0800-329-999 0266-026-066	http://www.samsung.com
VIETNAM	1 800 588 889	http://www.samsung.com

MIDDLE EAST		
IRAN	021-8255	http://www.samsung.com
OMAN	800-SAMSUNG(726-7864)	http://www.samsung.com
KUWAIT	183-2255	http://www.samsung.com
BAHRAIN	8000-4726	http://www.samsung.com
EGYPT	08000-726786	http://www.samsung.com
JORDAN	800-22273	http://www.samsung.com
MOROCCO	080 100 2255	http://www.samsung.com
SAUDI ARABIA	9200-21230	http://www.samsung.com
U.A.E	800-SAMSUNG (726-7864)	http://www.samsung.com
AFRICA		
CAMEROON	7095- 0077	http://www.samsung.com
COTE D' IVOIRE	8000 0077	http://www.samsung.com
GHANA	0800-10077 0302-200077	http://www.samsung.com
KENYA	0800 724 000	http://www.samsung.com
NIGERIA	0800-726-7864	http://www.samsung.com
SENEGAL	800-00-0077	http://www.samsung.com
SOUTH AFRICA	0860-SAMSUNG(726-7864)	http://www.samsung.com
TANZANIA	0685 88 99 00	http://www.samsung.com
UGANDA	0800 300 300	http://www.samsung.com

6-4 Correct Disposal of This Product (Waste Electrical & Electronic Equipment)



(Applicable in the European Union and other European countries with separate collection systems)

This marking on the product, accessories or literature indicates that the product and its electronic accessories (e.g. charger, headset, USB cable) should not be disposed of with other household waste at the end of their working life. To prevent possible harm to the environment or human health from uncontrolled waste disposal, please separate these items from other types of waste and recycle them responsibly to promote the sustainable reuse of material resources.

Household users should contact either the retailer where they purchased this product, or their local government office, for details of where and how they can take these items for environmentally safe recycling.

Business users should contact their supplier and check the terms and conditions of the purchase contract. This product and its electronic accessories should not be mixed with other commercial wastes for disposal.