

SAMSUNG

DVD Player

DVD-P180

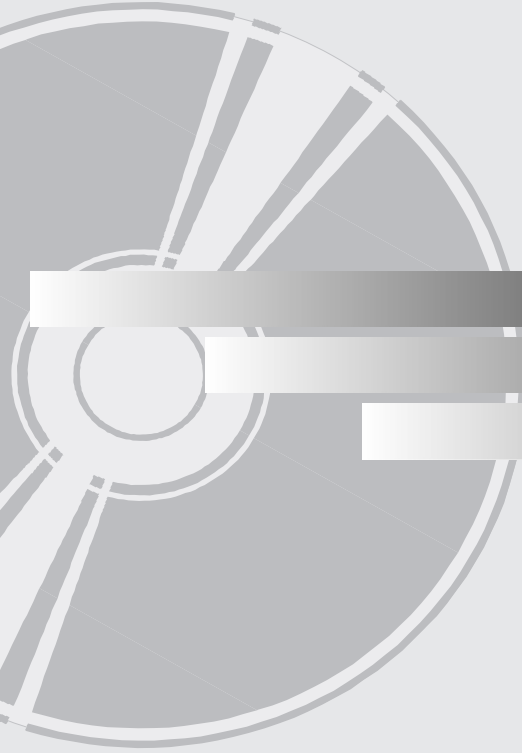

www.samsung.com/my

AK68-01640C

PRECAUTIONS

1. Setting up

- Refer to the identification label located on the rear of your player for its proper operating voltage.
- Install your player in a cabinet with adequate ventilation holes. (7~10cm) Do not block ventilation holes on any of the components for air circulation.
- Do not push the disc tray in by hand.
- Do not stack components.
- Be sure to turn all components off before moving the player.
- Before connecting other components to this player, be sure to turn them off.
- Be sure to remove the disc and turn off the player after use, especially if you don't use it for a long time.
- The mains plug is as a disconnect device and shall stay readily operable at any time.

2. For your safety

- This product utilizes a laser. Use of controls or adjustments or performance of procedures other than those specified herein may result in hazardous radiation exposure.
- Do not open covers and do not repair yourself. Refer servicing to qualified personal.

3. Caution

- Your player is not intended for industrial use but for domestic purposes. Use of this product is for personal use only.
- Apparatus shall not be exposed to dripping or splashing and no objects filled with liquids, such as vases, shall be placed on the apparatus.
- Exterior influences such as lightning and static electricity can affect normal operation of this player. If this occurs, turn the player off and on again with the POWER button, or disconnect and then reconnect the AC power cord to the AC power outlet. The player will operate normally.
- When condensation forms inside the player

due to sharp changes in temperature, the player may not operate correctly. If this occurs, leave the player at room temperature until the inside of the player becomes dry and operational.

4. Disc

- Do not clean record-cleaning sprays, benzene, thinner, or other volatile solvents that may cause damage to the disc surface.
- Do not touch the disc's signal surface. Hold by the edges or by one edge and the hole in the center.
- Wipe the dirt away gently; never wipe a cloth back and forth over the disc.

5. Environmental info

- The battery used in this product contains chemicals that are harmful to the environment.
- So, dispose of batteries in the proper manner, according to federal, state, and local regulations.

The product unit accompanying this user manual is licensed under certain intellectual property rights of certain third parties. This license is limited to private non-commercial use by end-user consumers for licensed contents. No rights are granted for commercial use. The license does not cover any product unit other than this product unit and the license does not extend to any unlicensed product unit or process conforming to ISO/OUR 11172-3 or ISO/OUR 13818-3 used or sold in combination with this product unit. The license only covers the use of this product unit to encode and/or decode audio files conforming to the ISO/OUR 11172-3 or ISO/OUR 13818-3. No rights are granted under this license for product features or functions that do not conform to the ISO/OUR 11172-3 or ISO/OUR 13818-3.

CAUTION: USE OF ANY CONTROLS, ADJUSTMENTS, OR PROCEDURES OTHER THAN SPECIFIED HEREIN MAY RESULT IN HAZARDOUS RADIATION EXPOSURE.

BEFORE YOU START



Remote Control

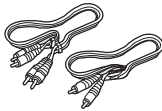

Video/Audio Cable

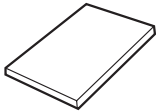

User's Manual

Install Batteries in the Remote control

1. Open the battery cover on the back of the remote control.
2. Insert two AAA batteries.
Make sure that the polarities (+ and -) are aligned correctly.
3. Replace the battery cover.

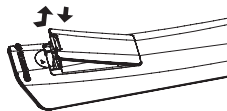

If remote control doesn't operate properly:

- Check the polarity + - of the batteries (Dry-Cell)
- Check if the batteries are drained.
- Check if remote control sensor is blocked by obstacles.
- Check if there is any fluorescent lighting nearby.

TABLE OF CONTENT

Precautions	2
Before you start	3
Setup	
General Features	4
Disc Type and Characteristics	5
Description	6
Tour of the Remote Control	8
Connections	
Choosing a Connection	9
Basic Functions	
Playing a Disc	12
Using the Search and Skip Functions	13
Using the Display Function	13
Using the Disc and Title Menu	14
Repeat Play	14
Slow Play	14
Advanced Functions	
Adjusting the Aspect Ratio (EZ View)	15
Selecting the Audio Language	15
Selecting the Subtitle Language.	16
Changing the Camera Angle	16
Using the Bookmark Function	16
Using the Zoom Function	17
Clips Menu for MP3/WMA/JPEG/ CD Audio	17
Folder Selection	17
MP3/WMA/CD Audio Playback.	17
Picture CD Playback.	18
Changing Setup Menu	
Using the Setup Menu	19
Setting Up the Language Features	20
Setting Up the Audio Options.	21
Setting Up the Display Options	21
Setting Up the Parental Control	22
Reference	
Firmware Upgrade	24
Troubleshooting	25
Specifications	26

SETUP

General Features

Excellent Sound

Dolby Digital, a technology developed by Dolby Laboratories, provides crystal clear sound reproduction.

Screen

Both regular and widescreen(16:9) pictures can be viewed.

Slow Motion

An important scene can be viewed in slow motion.

Parental Control (DVD)

The parental control allows users to set the level necessary to prohibit children from viewing harmful movies such as those with violence, adult subject matter, etc.

Various On-Screen Menu Functions

You can select various languages (Audio/Subtitle) and screen angles while enjoying movies.

EZ VIEW (DVD)

Easy View enables picture adjustment to match your TV's screen size (16:9 or 4:3).

Digital Photo Viewer (JPEG)

You can view Digital Photos on your TV.

Repeat

You can repeat a song or movie simply by pressing the REPEAT button.

MP3/WMA

This unit can play discs created from MP3/WMA files.

Note

- Discs which cannot be played with this player.
 - DVD-ROM
 - DVD-RAM
 - CD-ROM
 - CDV
 - CDI
 - CVD
 - CDGs play audio only, not graphics.
- Ability to play back may depend on recording conditions.
 - DVD-R, +R
 - CD-RW
 - DVD+RW, -RW (V mode)
- The unit may not play certain CD-R, CD-RW and DVD-R due to the disc type or recording conditions.



COPY PROTECTION

Many DVD discs are encoded with copy protection. Because of this, you should only connect your DVD player directly to your TV, not to a VCR. Connecting to a VCR results in a distorted picture from copy-protected DVD discs.







This product incorporates copyright protection technology that is protected by methods claims of certain U.S. patents and other intellectual property rights owned by Macrovision Corporation and other rights owners. Use of this copyright protection technology must be authorized by Macrovision Corporation, and is intended for home and other limited viewing uses only unless otherwise authorized by Macrovision Corporation. Reverse engineering or disassembly is prohibited.

Disc Type and Characteristics

This DVD player is capable of playing the following types of discs with the corresponding logos:

Disc Types (Logos)	Recording Types	Disc Size	Max. Playing Time	Characteristics
DVD 	Audio + Video	12 Cm	Single-sided 240 min. Double-sided 480 min.	<ul style="list-style-type: none"> - DVD contains excellent sound and video due to Dolby Digital and MPEG-2 system. - Various screen and audio functions can be easily selected through the on-screen menu.
		8 Cm	Single-sided 80 min. Double-sided 160 min.	
VIDEO-CD 	Audio + Video	12 Cm	74 min.	<ul style="list-style-type: none"> - Video with CD sound, VHS quality & MPEG-1 compression technology.
		8 Cm	20 min.	
AUDIO-CD 	Audio	12 Cm	74 min.	<ul style="list-style-type: none"> - CD is recorded as a Digital Signal with better audio quality, less distortion and less deterioration of audio quality over time.
		8 Cm	20 min.	

Disc Markings

	Play Region Number
	PAL broadcast system in U.K, France, Germany, etc.
	Dolby Digital disc
	Stereo disc
	Digital Audio disc
	DTS disc
	MP3 disc

You must only insert one DVD disc at a time. Inserting two or more discs will not allow to play them back and it may cause damage to the DVD player.

Region Number

Both the DVD player and the discs are coded by region. These regional codes must match in order for the disc to play. If the codes do not match, the disc will not play.

The Region Number for this player is described on the rear panel of the player.

Description

Front Panel Controls



1. STANDBY/ON (⏻)

When STANDBY/ON is pressed on, the indicator goes out and the player is turned on.

2. STANDBY indicator

When the unit is first plugged in, this indicator lights.

3. DISC TRAY

Place the disc here.

4. REMOTE SENSOR

5. OPEN/CLOSE /STOP (■)

Stops disc play.

Press to open and close the disc tray.

6. PLAY/PAUSE (⏮)

Begin or pause disc play.

Rear Panel

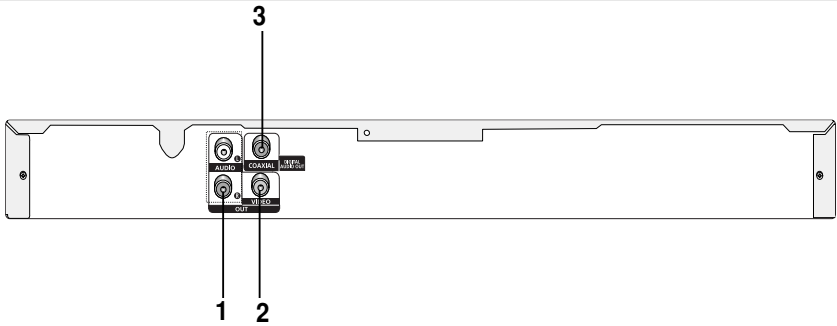

1. AUDIO OUT JACKS

- Connect to the Audio input jacks of your television or audio/video receiver.

2. VIDEO OUT JACK

- Use a video cable to connect to the Video input jack on your television.

3. DIGITAL AUDIO OUT JACKS

- Use either coaxial digital cable to connect to a compatible Dolby Digital receiver.
- Use either coaxial digital cable to connect to an A/V Amplifier that contains a Dolby Digital, MPEG2 or DTS decoder.

Note

- See pages 21-22 to get more information on how to use the setup menu.

Tour of the Remote Control

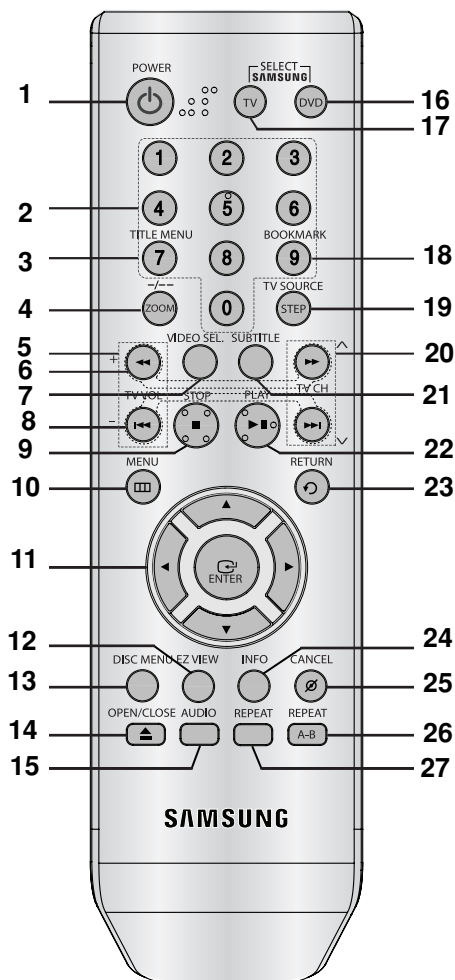

1. **DVD Power Button**
Turns the power on or standby.
2. **NUMBER Buttons**
3. **TITLE MENU (number 7) Button**
Brings up the Title menu.
4. **ZOOM/- /-- Button**
Enlarge DVD Picture
Use this button to select the channel of TV program by inserted the channel number (TV mode).
5. **TV VOLUME**
TV VOL(+,-) button

6. **SEARCH Buttons (◀◀ / ▶▶)**
Allow you to search forward/backward through a disc.
7. **VIDEO SEL.Button**
(Only for DVD-P181/DVD-P181K)
8. **SKIP Buttons (◀◀ / ▶▶)**
Use to skip the title, chapter or track.
9. **STOP Button (■)**
10. **MENU Button**
Brings up the DVD player's menu.
11. **ENTER/▲/▼,◀/▶ Buttons**
This button functions as a toggle switch.
12. **EZ VIEW Button**
The aspect ratio of a picture can easily be adjusted according to the screen size of your TV (16:9 or 4:3)
13. **DISC MENU Button**
Brings up the Disc menu.
14. **OPEN/CLOSE (▲) Button**
To open and close the disc tray
15. **AUDIO Button**
Use this button to access various audio functions on a disc.
16. **DVD Button**
Use to operate DVD
17. **TV Button**
Use to operate TV.
18. **BOOKMARK (Number 9 Button)**
Quickly find bookmark sections of a DVD
19. **STEP /TV SOURCE Button**
Advances play one frame at a time.
20. **TV CH Buttons**
Use to change channel.
21. **SUBTITLE Button**
22. **PLAY/PAUSE Button (▶||)**
Begin/Pause disc play.
23. **RETURN Button**
Returns to a previous menu.
24. **INFO Button**
Displays the current disc mode.
25. **CANCEL Button**
Use to remove menus or status displays from the screen.
26. **REPEAT A-B Button**
Allows you to repeat A-B disc.
27. **REPEAT Button**
Allows you to repeat play a title, chapter, track, or disc.

CONNECTIONS

Choosing a Connection

The following shows examples of connections commonly used to connect the DVD player with a TV and other components.

Before Connecting the DVD Player

- Always turn off the DVD player, TV, and other components before you connect or disconnect any cables.
- Refer to the user's manual of the additional components you are connecting for more information on those particular components.

Connection to a TV (For Video)

1

Using video/audio cable, connect the **VIDEO (yellow)/Audio (red and white)** terminals on the rear of the DVD player to the **VIDEO (yellow)/Audio (red and white) IN** terminals of TV.

2

Turn on the DVD player and TV.

3

Press the **TV/VIDEO** button on the TV's remote control to select **Video**.

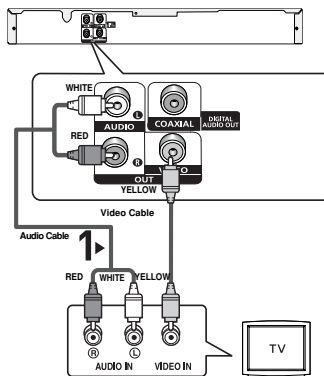

Note

- **Noise may be generated if the audio cable is too close to the power cable.**
- If you want to connect to an Amplifier, please refer to the Amplifier connection page. (See pages 10 to 11)
- The number and position of terminals can vary depending on your TV set. Please refer to the user's manual of the TV.

Connection to an Audio System (2 Channel Amplifier)

1

Using the audio cables, connect the **AUDIO (red and white) OUT** on the rear of the DVD player to the **AUDIO (red and white) IN** terminals of the Amplifier.

2

Using the video signal cable, connect the **VIDEO** terminals on the rear of the DVD player to the **VIDEO** terminal of your TV.

3

Turn on the DVD player, TV, and Amplifier.

4

Press the input select button of the Amplifier to select **external input** in order to hear sound from the DVD player.

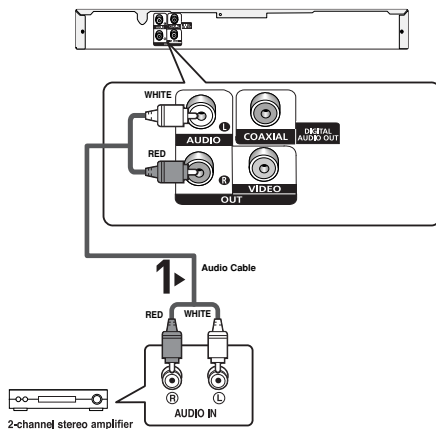

Note

- **Please turn the volume down when you turn on the Amplifier. Sudden loud sound may cause damage to the speakers and your ears.**
- Please set the audio in the menu screen according to the Amplifier. (See pages 21)
- The position of terminals can vary depending on the Amplifier. Please refer to the user's manual of the Amplifier.

Connection to an Audio System (Dolby digital, MPEG2 or DTS Amplifier)

1

If using a coaxial cable (not included), connect the **DIGITAL AUDIO OUT (COAXIAL)** terminal on the rear of the DVD player to the **DIGITAL AUDIO IN (COAXIAL)** terminal of the Amplifier.

2

Using the video signal cable, connect the **VIDEO** terminals on the rear of the DVD player to the **VIDEO** terminal of TV.

3

Turn on the DVD player, TV, and Amplifier.

4

Press the input select button of the Amplifier to select **external input** in order to hear sound from the DVD player.

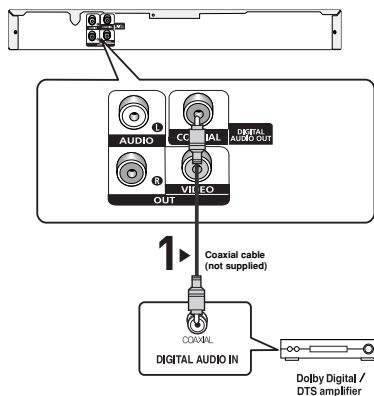

Note

- **Please turn the volume down when you turn on the Amplifier. Sudden loud sound may cause damage to the speakers and your ears.**
- Please set the audio in the menu screen according to the Amplifier. (See pages 21)
- The position of terminals can vary depending on the Amplifier. Please refer to the user's manual of the Amplifier.

BASIC FUNCTIONS

Playing a Disc

Before Play





- Turn on your TV and set it to the correct Video Input by pressing TV/VIDEO button on the TV remote control.
- If you connected an external Audio System, turn on your Audio System and set it to the correct Audio Input.

After plugging in the player, the first time you press the DVD **POWER** button, this screen comes up: If you want to select a language, press a **NUMBER** button. (This screen will only appear when you plug in the player for the first time.) If the language for the startup screen is not set, the settings may change whenever you turn the power on or off. Therefore, make sure that you select the language you want to use.

Once you select a menu language, you can change it by pressing the  button on the front panel of the unit for more than 5 seconds with no disc in the unit. Then the **SELECT MENU LANGUAGE** window appears again where you can reset your preferred language.

SELECT MENU LANGUAGE		
Press	1	for English
Touche	2	pour Français
Drücken Sie	3	für Deutsch
Pulsar	4	para Español
Premere	5	per Italiano
Druk op	6	voor Nederlands

Playback

1. Press the **OPEN/CLOSE** () button. The **STANDBY** indicator light goes out and the tray opens.
2. Place a disc gently into the tray with the disc's label facing up.
 - You must only insert one DVD disc at a time. Inserting two or more discs will not allow to play them back and it may cause damage to the DVD player.
3. Press the **PLAY/PAUSE** () button or **OPEN/ CLOSE** () button to close the disc tray.
 - When you stop disc play, the player remembers where you stopped, so when you press **PLAY/PAUSE** () button again, it will pick up where you left off. (unless the disc is removed or the player is unplugged, or if you press the **STOP** () button twice.)

4. Stopping Play

Press the **STOP** () button during play.

5. Removing Disc

Press the **OPEN/CLOSE** () button.

6. Pausing Play

Press the **PLAY/PAUSE** () or **STEP** button on the remote control during play.

- Screen stops, no sound.

To resume, press the **PLAY/PAUSE** () button once again.

7. Step Motion Play (Except CD)

Press the **STEP** button on the remote control during play.

- Each time the button is pressed, a new frame will appear.

- No sound is heard during STEP mode.

- Press the **PLAY/PAUSE** () button to resume normal play.

- You can only perform step motion play in the forward direction.

8. Slow Motion Play

Press **SEARCH** () button to choose



the play speed between 1/2, 1/4, 1/8 and 1/16 of normal during PAUSE mode.

- No sound is heard during slow mode.

- Press the **PLAY/PAUSE** () button to resume normal play.

- Reverse slow motion play will not work.

Note

- If the player is left in the stop mode for more than one minute without any user interaction, a screen saver will be activated. Press the **PLAY/PAUSE** () button to resume normal play.
- If the player is left in the stop mode for more than about 30 minutes, the power will automatically shut off. (Automatic Power-Off Function)
- If the player is left for about 5 minutes in pause mode, it will stop.
- This () icon indicates an invalid button press.

Using the Search and Skip Functions

During play, you can search quickly through a chapter or track, and use the skip function to jump to the next selection.

Searching through a Chapter or Track.

During play, press the **SEARCH** (◀▶) button on the remote control.

DVD	2X, 4X, 64X, 128X
VCD	4X, 8X
CD	2X, 4X, 8X

Note

- The speed marked in this function may be different from the actual speed of playback.
- No sound is hearing during search mode (Except CD).

Skipping Tracks

During play, press the **SKIP** (◀◀ or ▶▶) button.







- When playing a DVD, if you press the SKIP (▶▶) button, it moves to the next chapter. If you press the SKIP (◀◀) button, it moves to the beginning of the chapter. One more press makes it move to the beginning of the previous chapter.
- When playing a CD, in Menu Off mode, if you press the SKIP (▶▶) button, it moves to the next track. If you press the SKIP (◀◀) button, it moves to the beginning of the track. One more press makes it move to the beginning of the previous track.

Using the Display Function

When Playing a DVD/VCD

1. During play, press the **INFO** button on the remote control.
2. Press the ▲/▼ buttons to select the desired item.
3. Press the ◀/▶ buttons to make the desired setup and then press the **ENTER** button.
 - You may use the number buttons of the remote control to directly access a title, chapter or to start the playback from the desired time.
4. To make the screen disappear, press the **RETURN** button again.

Note

	To access the desired title when there is more than one in the disc. For example, if there is more than one movie on a DVD, each movie will be identified.
	Most DVD discs are recorded in chapters so that you can quickly find a specific passage
	Allows playback of the film from a desired time. You must enter the starting time as a reference. The time search function does not operate on some disc.
	Refers to the language of the film soundtrack. In the example, the soundtrack is played in English 5.1CH. A DVD disc can have up to eight different soundtracks.
	Refers to the subtitle languages available in the disc. You will be able to choose the subtitle languages or, if you prefer, turn them off from the screen. A DVD disc can have up to 32 different subtitles.
	To access the desired Bookmark or Angle function. Some DVD discs can have more angle function from any picture. Bookmark function make you easily and quickly to find a track or chapter from DVD.

Using the Disc and Title Menu

Using the Disc Menu

1. Press the **MENU** button on the remote control.
2. Press the ▲/▼ buttons to select **Disc Menu**, then press the ▶ or **ENTER** button.

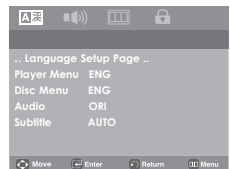

Note

- Depending on a disc, the Disc Menu may not work.
- You can also use the Disc Menu, using the DISC MENU button on the remote control.

Repeat Play

Press the REPEAT button to change playback mode.

When playing a DVD/VCD

- DVD repeat play by chapter, title, disc repeat play by disc or track.
- Chapter : repeats the chapter that is playing.
- Title : repeats the title that is playing.
- Disc : repeats the disc that is playing.
- Track : repeats the track that is playing.
- Off

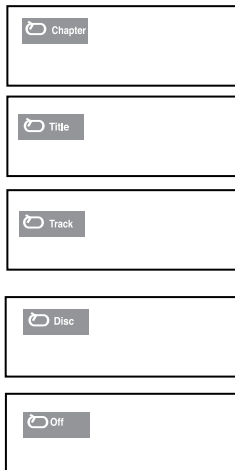

Using the A-B Repeat function

1. Press the **REPEAT A-B** button on the remote at the point where you want repeat play to start (A).
2. Press the **REPEAT A-B** button on the remote at the point where you want the repeat play to stop (B).
3. To return to normal play, press REPEAT A-B button again.

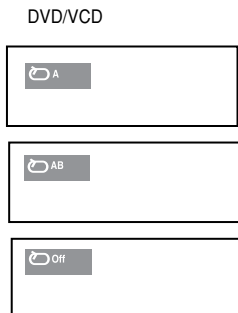

Not

- A-B REPEAT allows you to set point(B) directly after point (A) has been set.
- Depending on a disc, the Repeat function may not work.

Slow Play

This feature allows you slowly to repeat scenes containing sports, dancing, musical instruments being played etc., so you can study them more closely.

When playing a DVD

1. During play, press the **PLAY/PAUSE** (▶||) button.
2. Press the **SEARCH** (▶▶) button repeatedly to choose the play speed between 1/2, 1/4, 1/8, 1/16 of normal during **PAUSE** mode.

ADVANCED FUNCTIONS

Adjusting the Aspect Ratio (EZ View)

To play back using aspect ratio (DVD)

Press the **EZ VIEW** button.

- The screen size changes when the button is pressed repeatedly.
- The screen zoom mode operates differently depending on the screen setting in the Display Setup menu.
- To ensure correct operation of the **EZ VIEW** button, you should set the correct aspect ratio in the Display Setup menu. (See pages 21 to 22).



If you are using a 16:9 TV

For 16:9 aspect ratio discs

- **WIDE SCREEN**
Displays the content of the DVD title in 16:9 aspect ratio.
- **SCREEN FIT**
The top and bottom portions of the screen are cut off. When playing a 2.35:1 aspect ratio disc, the black bars at the top and bottom of the screen will disappear. The picture will look vertically stretched. (Depending on a type of disc, the black bars may not disappear completely.)
- **ZOOM FIT**
The top, bottom, left and right of the screen are cut off and the central portion of the screen is enlarge

For 4:3 aspect ratio discs

- **Normal Wide**
Displays the content of the DVD title in 16:9 aspect ratio. The picture will look horizontally stretched.
- **SCREEN FIT**
The top and bottom portions of the screen are cut off and the full screen appears. The picture will look vertically stretched.
- **ZOOM FIT**
The top, bottom, left and right portions of the screen are cut off and the central portion of the screen is enlarged.
- **Vertical Fit**
When a 4:3 DVD is viewed on a 16:9 TV, black bars will appear at the left and right of the screen in order to prevent the picture from looking horizontally stretched.

If you are using a 4:3 TV

For 16:9 aspect ratio discs

- **4:3 Letter Box**
Displays the content of the DVD title in 16:9 aspect ratio. The black bars will appear at the top and bottom of the screen.
- **4:3 Pan&Scan**
The left and right portions of the screen are cut off and the central portion of the 16:9 screen is displayed.
- **SCREEN FIT**
The top and bottom portions of the screen are cut off and a full screen appears. The picture will look vertically stretched.
- **ZOOM FIT**
The top, bottom, left and right of the screen are cut off and the central portion of the screen is enlarged.

For 4:3 aspect ratio discs

- **Normal Screen**
Displays the content of the DVD title in 4:3 aspect ratio.
- **SCREEN FIT**
The top and bottom portions of the screen are cut off and the full screen appears. The picture will look vertically stretched.
- **ZOOM FIT**
The top, bottom, left and right portions of the screen are cut off and the central portion of the screen is enlarged.

Note

This function may behave differently depending on the type of disc.

Selecting the Audio Language

You can select a desired audio language quickly and easily with the **AUDIO** button.

Using the **AUDIO** button

1. Press the Audio button. The Audio changes when the audio button is press repeatedly.
The audio languages are represented by abbreviations.

DVD

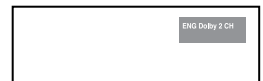

2. To remove the **AUDIO** icon, press the **CANCEL** or **RETURN** button.

Note

- This function depends on audio languages are encoded on the disc and may not work.
- A DVD disc can contain up to 8 audio languages.
- To have the same audio language come up whenever you play a DVD; Refer to "Using the Audio Language" on page 20.



Selecting the Subtitle Language

You can select a desired subtitle quickly and easily with the SUBTITLE button.

Using the SUBTITLE button (DVD)

1. Press the **SUBTITLE** button. The subtitle languages are represented by abbreviations. The subtitle changes when the button is pressed repeatedly.

DVD

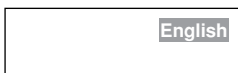

Note

- You have to change the desired subtitle in the Disc Menu, according to discs. Press the **INFO MENU** button.
- This function depends on what subtitles are encoded on the disc and may not work on all DVDs.
- A DVD disc can contain up to 32 subtitle languages.
- To have the same subtitle language come up whenever you play a DVD; Refer to "Using the Subtitle Language" on page 20.

Changing the Camera Angle

When a DVD contains multiple angles of a particular scene, you can use the ANGLE function.

Using the ANGLE Function (DVD).

If the disc contains multiple angles, the ANGLE appears on the screen.

1. During play, press the **INFO** button on the remote control.
2. Press the **▲/▼** buttons to select **ANGLE**.
3. Press the **◀/▶** buttons or you can use the number buttons on the remote control to select the desired angle **Angle**.

Using the Bookmark Function

This feature lets you bookmark sections of a DVD so you can quickly find them at a later time.

Using the Bookmark Function (DVD)

1. During play, press the **Bookmark** button on the remote control.

DVD



2. When you reach the scene you want to mark, press the **ENTER** button. Up to 12 scenes may be marked at a time.



Note

- Depending on a disc, the Bookmark function may not work.

Recalling a Marked Scene

1. During play, press the bookmark button on the remote control.
2. Press the **▲/▼/◀/▶** buttons to select a marked scene.



3. Press the **PLAY/PAUSE (▶||)** button to skip to the marked scene.

Clearing a Bookmark

1. During play, press the **Bookmark** button on the remote control.
2. Press the **▲/▼/◀/▶** buttons to select the bookmark number you want to delete.
3. Press the **CANCEL** button to delete a bookmark number.

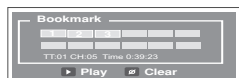

Using the Zoom Function

Using the Zoom Function (DVD)

- During DVD play or pause mode, press **ZOOM** button on the remote control repeatedly to zoom in 2X/3X/4X

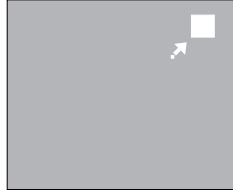









Clips Menu for MP3/WMA/JPEG/CD Audio

CD Audio or discs with MP3/WMA/JPEG contain individual songs and/or pictures that can be organized into folders as shown below. They are similar to how you use your computer to put files into different folders.

- Open the disc tray.
- Place the disc on the tray.
- Close the tray.
- The tray closes and this screen displays.



-  : Current Playback Mode : There are four modes. They can be selected in order by pressing the **REPEAT** button.
 - Off: Normal Playback
 - Track: Repeats the current track.
 - Folder: Repeats the current folder.
 - Random: Files in the disc will be played in random order.

-  : STOP file icon.
-  : PLAY file icon
-  : WMA file icon
-  : MP3 file icon.
-  : JPG file icon.
-  : CD file icon.
-  : Folder file icon
-  : current file icon

Folder Selection

- To select the Parent Folder

Press the **RETURN** button to go to parent folder, or press the **▲/▼** buttons to select “..” and press **ENTER** to go to the parent folder.

MP3/WMA/CD Audio Playback

1. Open the disc tray. Place the disc on the tray. Close the tray.
 - Only one kind of file is played back when a disc or a folder contains both MP3 and WMA files.
2. Press the **▲/▼** buttons to select a song file. Press **ENTER** to begin playback of the song file.



Repeat/Random playback

Press the **REPEAT** button to change the playback mode. There are four modes, such as **Off**, **Track**, **Folder** and **Random**.

- Off: Normal Playback
- Track: Repeats the current song file.
- Folder: Repeats the song files which have the same extension in the current folder.
- Random: Song files which have the same extension will be played in random order.

CD-R MP3/WMA file

When you record MP3 or WMA files on CD-R, please refer to the following.

- Your MP3 or WMA files should be ISO 9660 or JOLIET format.

ISO 9660 format and Joliet MP3 or WMA files are compatible with Microsoft's DOS and Windows, and with Apple's Mac. This format is the most widely used.

- When naming your MP3 or WMA files, do not exceed 8 characters, and enter ".mp3, .wma" as the file extension.

General name format : Title.mp3. or Title.wma. When composing your title, make sure that you use 8 characters or less, have no spaces in the name, and avoid the use of special characters including: (,.,\,=,+).

- Use a decompression transfer rate of at least 128 Kbps when recording MP3 files.

Sound quality with MP3 files basically depends on the rate of compression/decompression you choose. Getting CD audio sound requires an analog/digital sampling rate, that is conversion to MP3 format, of at least 128 Kbps and up to 160 Kbps. However, choosing higher rates, like 192 Kbps or more, only rarely give better sound quality. Conversely, files with decompression rates below 128 Kbps will not be played properly.

- Use a decompression transfer rate of at least 64Kbps when recording WMA files.

Sound quality with WMA files basically depends on the rate of compression/decompression you choose.

Getting CD audio sound requires an analog/digital sampling rate, that is conversion to WMA format, of at least 64Kbps and up to 192Kbps. Conversely, files with decompression rates below 64Kbps or over 192Kbps will not be played properly.

- Do not try recording copyright protected MP3 files.

Certain "secured" files are encrypted and code protected to prevent illegal copying. These files are of the following types: Windows Media™ (registered trade mark of Microsoft Inc) and SDMI™ (registered trade mark of The SDMI Foundation). You cannot copy such files.

- **Important:**

The above recommendations cannot be taken as a guarantee that the DVD player will play MP3 recordings, or as an assurance of sound quality. You should note that certain technologies and methods for MP3 file recording on CD-Rs prevent optimal playback of these files on your DVD player (degraded sound quality and in some cases, inability of the player to read the files).

- This unit can play a maximum of 500 files and 500 folders per disc.

Picture CD Playback

1. Select the desired folder.
2. Press the ▲/▼ buttons to select a Picture file in the clips menu and then press the ENTER button.

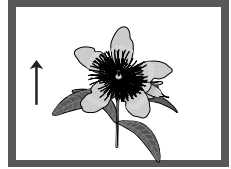

Rotation

- Each time the ◀/▶ button is pressed, the picture rotates 90 degree clockwise.

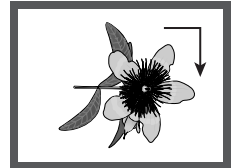

- Each time the ▲ button is pressed, the picture rotate 180 degree.

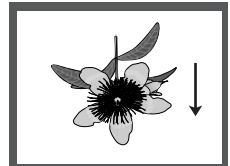

- Each time the ▼ button is pressed, the picture go to mirror appearance.

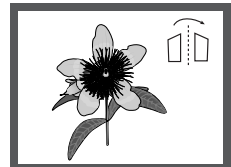

Zoom

- Each time number 7 is pressed, the picture is enlarged.
zoom mode : 100% -125%-150%-200%-100% .

Slide show

- When you press the ENTER/PLAY at JPEG file, it will go to full screen mode and automatically slide show.

Note

- Depending on a file size, the amount of time between each picture may be different from the manual.
- If you don't press any button, the slide show will start automatically in about 8 seconds by default.

CD-R JPEG Discs

- Only files with the ".jpg" and ".JPG" extensions can be played.
- If the disc is not closed, it will take longer to start playing and not all of the recorded files may be played.
- Only CD-R discs with JPEG files in ISO 9660 or Joliet format can be played.
- The name of the JPEG file may not be longer than 8 characters and should contain no blank spaces or special characters (. / = +).
- Only a consecutively written multi-session disc can be played. If there is a blank segment in the multi-session disc, the disc can be played only up to the blank segment.
- A maximum of 500 images can be stored on a single CD.
- Kodak Picture CDs are recommended.
- When playing a Kodak Picture CD, only the JPEG files in the pictures folder can be played.
- When playing a Kodak Picture CD, only the JPEG files in the pictures folder can be played.
- Kodak Picture CD: The JPEG files in the pictures folder can be played automatically.
- Konica Picture CD: If you want to see the Picture, select the JPEG files in the clips menu.
- Fuji Picture CD: If you want to see the Picture, select the JPEG files in the clips menu.
- QSS Picture CD: The unit may not play QSS Picture CD.
- If the number of files in 1 Disc is over 500, only 500 JPEG files can be played.
- If the number of folders in 1 Disc is over 500, only JPEG files in 500 folders can be played

CHANGING SETUP MENU

Using the Setup Menu

The Setup menu lets you customize your DVD player by allowing you to select various language preferences, set up a parental level, even adjust the player to the type of television screen you have.

1. Press the **MENU** button on the remote control. Use the ◀▶ buttons to select Setup, then press the ▼ or **ENTER** button.

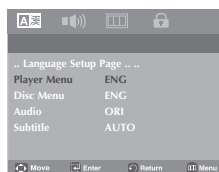

- 1 Language Setup page: Setup of the Language.
 - 2 Audio Setup page: Setup of the Audio Options.
 - 3 Display Setup page: Setup of the Display Options. Use to select which type of screen you want to watch and several display options.
 - 4 Parental Setup page: Setup of the Parental Level. Allows users to set the level necessary to prevent children from viewing unsuitable movies such as those with violence, adult subject matter, etc.
2. Press the ◀▶ buttons to access the different features. Press the ▼ or **ENTER** button to access the sub features.
 3. To make the setup screen disappear after setting up, press the **MENU** button again.

Note

Depending on the disc, some Setup Menu selections may not work.

Setting Up the Language Features

If you set the player menu, disc menu, audio and subtitle language in advance, they will come up automatically every time you watch a movie.

Using the Player Menu Language

1. Press the **MENU** button.
2. Press the ◀/▶ buttons to select **Language Setup**, then press the ▼ or **ENTER** button.
3. Press the ▲/▼ buttons to select **Player Menu**, then press the ▶ or **ENTER** button.
4. Press the ▲/▼ buttons to select the desired language, then press **ENTER** button.
 - The language is selected and the screen returns to Language Setup page.
 - To make the setup menu disappear, press the MENU button.

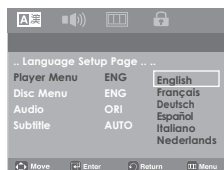

Using the Disc Menu Language

This function changes the text language only on the disc menu screens.

1. Press the **MENU** button.
2. Press the ◀/▶ buttons to select **Language Setup page**, then press the ▼ or **ENTER** button.
3. Press the ▲/▼ buttons to select **Disc Menu**, then press the **ENTER** button.
4. Press the ▲/▼ buttons to select the desired language, then press the **ENTER** button.
 - The language is selected and the screen returns to Language Setup page
 - To make the setup menu disappear, press the MENU button.

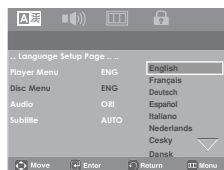

Using the Audio Language

1. Press the **MENU** button.
2. Press the ◀/▶ buttons to select **Language Setup page**, then press the ▼ or **ENTER** button.
3. Press the ▲/▼ buttons to select **Audio**, then press **ENTER** button.
4. Press the ▲/▼ buttons to select the desired language, then press **ENTER** button.
 - Select "Original" if you want the default soundtrack language to be the original language the disc is recorded in.
 - If the selected language is not recorded on the disc, the original pre-recorded language is selected.
 - The language is selected and the screen returns to Language Setup menu.
 - To make the setup menu disappear, press the MENU button.

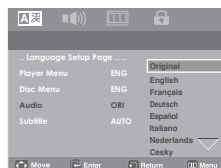

Using the Subtitle Language

1. Press the **MENU** button.
2. Press the ◀/▶ buttons to select **Language Setup**, then press the ▼ or **ENTER** button.
3. Press the ▲/▼ buttons to select **Subtitle**, then press the ▶ or **ENTER** button.
4. Press the ▲/▼ buttons to select the desired language, then press the **ENTER** button.
 - Select "Automatic" if you want the subtitle language to be the same as the language selected as the audio language.
 - Some discs may not contain the language you select as your initial language; in that case the disc will use its original language setting.
 - The language is selected and the screen returns to setup menu.
 - To make the setup menu disappear, press the MENU button.

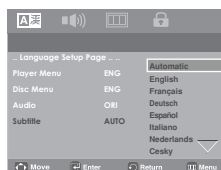

Setting Up the Audio Options

Audio Options allows you to setup the audio device and sound status settings depending on the audio system in use.

1. Press the **MENU** button.
2. Press the ◀/▶ buttons to select **Audio Setup**, then press the ▼ or **ENTER** button.
3. Press the ▲/▼ buttons to select the desired item, then press the ▶ or **ENTER** button.

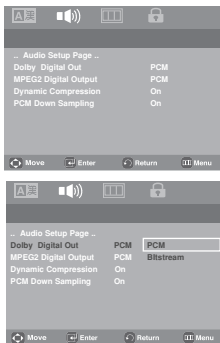

1 Dolby Digital Out

- PCM : Converts to PCM(2CH) audio.
- Bitstream : Outputs Dolby Digital via the digital output. Select Bitstream when connecting to a Dolby Digital Decoder.

2 MPEG-2 Digital Output

- PCM : Converts to PCM(2CH) audio.
- Bitstream : Converts to MPEG-2 Digital Bitstream

(5.1CH or 8CH). Select Bitstream when using the Digital Audio Output.

3 Dynamic Compression

- On : To select dynamic compression.
- Off : To select the standard range.

4 PCM Down Sampling

- On : Select this when the Amplifier connected to the player is not 96KHz compatible. In this case, the 96KHz signals will be down converted to 48KHz.
- Off : Select this when the Amplifier connected to the player is 96KHz compatible. In this case, all signals will be output without any changes.

Note

Even when PCM Down sampling is Off

- Some discs will only output down sampled audio through the digital outputs.
- To make the Setup menu disappear, press the **MENU** button.

Manufactured under license from Dolby Laboratories. "Dolby" and the double-D symbol are trademarks of Dolby Laboratories.

"DTS" and "DTS Digital Out" are trademarks of Digital Theater Systems, Inc.

Setting Up the Display Options

Display options enable you to set various video functions of the player.

1. Press the **MENU** button.
2. Press the ◀/▶ buttons to select **Display Setup page** then press the ▼ or **ENTER** button.
3. Press the ▲/▼ buttons to select the desired item, then press the ▶ or **ENTER** button.

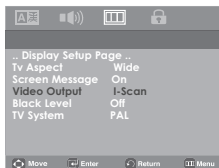

1 TV Aspect

Depending on a type of television you have, you may want to adjust the screen setting (aspect ratio).

- 4:3 Pan&Scan : Select this for conventional size TVs when you want to see the central portion of the 16:9 screen. (Extreme left and right side of movie picture will be cut off.)
- 4:3 Letter Box : Select when you want to see the total 16:9 ratio screen DVD supplies, even though you have a TV with a 4:3 ratio screen. Black bars will appear at the top and bottom of the screen.
- 16:9 Wide : You can view the full 16:9 picture on your wide screen TV.

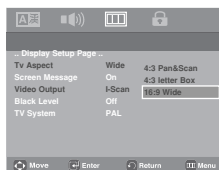

2 Screen Message

Use to turn on-screen messages On or Off.

3 Video Output

(Only for model DVD-P181/DVD-P181K)

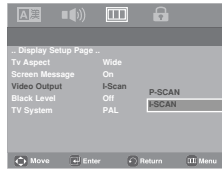

4 Black Level

Adjusts the brightness of the screen.

5 TV System

- NTSC : In case of using NTSC disc

- If your TV system only has PAL-Video input, you must choose "PAL". When you choose "PAL", Interlace output format is PAL 60 Hz output.

- If your TV system only has NTSC, input you must choose "NTSC".

- If you set up the NTSC TV system

- PAL : In case of using PAL disc

- If your TV system only has NTSC-Video input, you must choose "NTSC".

- If your TV system only has PAL input, you must choose "PAL".

- If you set up the PAL TV system.

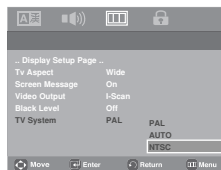

Setting Up the Parental Control

The Parental Control function works in conjunction with DVDs that have been assigned a rating, which helps you control the types of DVDs that your family watches. There are up to 8 rating levels on a disc.

Setting Up the Rating Level

1. Press the **MENU** button.
2. Press the ◀/▶ buttons to select **parental setup page**, then press the ▼ or **ENTER** button.

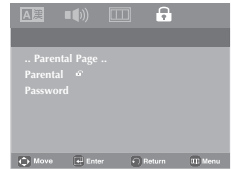

3. Press the ▲/▼ buttons to select **Parental**, then press the ▶ or **ENTER** button.

4. Press the ▲/▼ buttons to select the Rating Level you want, then press the **ENTER** button.
e.g) Setting up in **KID SAFE**



5. Enter your password.
 - By default, password is set to 0000.

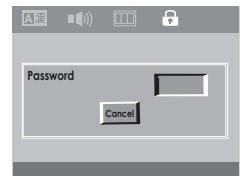

Note

① KID SAFE

② **G**(General Audiences) : All Ages Admitted

③ **PG**(Parental Guidance suggested): Some material may not be suitable for young children.

④ **PG-13** (PG-13-Parents strongly cautioned) : Some material may be inappropriate for children under 13

⑤ **PGR** (parental guidance Recommended): These are not necessarily unsuitable for children, but viewer discretion is advised, and parents and guardians are encouraged to supervise younger viewers.

⑥ **R**(Restricted): Under 17 requires accompanying adult

⑦ **NC17 (NC-17)** : No one 17 and under admitted

⑧ **Adult**



Note

If you have forgotten your password, see “Forgot Password” in the Troubleshooting Guide.

Note

- To make the setup menu disappear, press the MENU button. For example, if you select up to level R, discs that contain NC17, Adult will not play.

Changing the Password

- Press the **MENU** button.
- Press the ◀▶ buttons to select **parental setup page**, then press the ▼ or **ENTER** button.



- Press the ▲/▼ buttons to select **PASSWORD**, then press the ▶ or **ENTER** button.

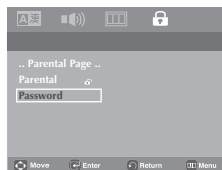

- The Enter password screen appear. Enter your password (default password), Enter the new password again

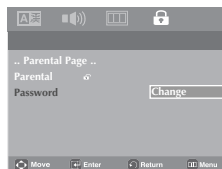

REFERENCE

Firmware upgrade

Introduction

Samsung will often support the software upgrade to improve the performance of this unit to the latest status, through Samsung Internet Site (www.samsung.com)

What improvements are made depends on the upgrade software you are using as well as the software that your DVD-player contained before the upgrade.

How to make an upgrade disc

Write the downloaded file onto a blank CD-R or CD-RW disc, using the following settings:

1. You have to download a new file through Download center of Samsung Internet Site (<http://www.samsung.com>).
2. Write the file to disc using CD-RW driver of your computer.

Note

- File system CD-ROM
- Character set ISO 9660
- Finalized, single session
- Write speed low

Update procedure

1. Open the disc tray. Place disc in the tray, close the tray. The Firmware Upgrade screen appears.

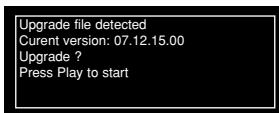

Firmware upgrade appears on the display

2. Press enter or play to start upgrade.
 - Other key to cancel upgrade back to Samsung logo and eject the disc.



Firmware upgrade starts

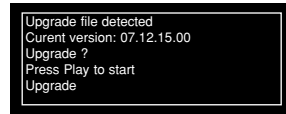

Firmware upgrade starts

- In the middle of the writing, the tray will open automatically. After taking out the disc, please wait for about 2 minutes.
- If the unit was successfully updated, the unit will turn off and on after closing the tray automatically. When the unit turns on, this screen will display.

3. Press the number buttons to select the desired language



SELECT MENU LANGUAGE		
Press	1	for English
Touche	2	pour Français
Drücken Sie	3	für Deutsch
Pulsar	4	para Español
Premere	5	per Italiano
Druk op	6	voor Nederlands

Note

- If the "Select Menu Language" doesn't appear, please contact to "Samsung Service Center". If the unit was successfully updated, the unit will turn off and on after closing the tray automatically.
- Do not press any button and plug the power cord during upgrade.
- The upgrade procedure may change, refer to the web site (www.samsung.com)

Troubleshooting

Before requesting service (troubleshooting), please check the following.

Problem	Action	Page
No operations can be performed with the remote control.	<ul style="list-style-type: none"> • Check the batteries in the remote control. They may need replacing. • Operate the remote control at a distance of no more than 20 feet. • Remove batteries and hold down one or more buttons for several minutes to drain the microprocessor inside the remote control to reset it. Reinstall batteries and try to operate the remote control again. 	P3
Disc does not play.	<ul style="list-style-type: none"> • Ensure that the disc is installed with the label side facing up. • Check the region number of the DVD. 	P5
5.1 channel sound is not being reproduced.	<ul style="list-style-type: none"> • 5.1 channel sound is reproduced only when the following conditions are met. : <ol style="list-style-type: none"> 1) The DVD player is connected with the proper Amplifier 2) The disc is recorded with 5.1 channel sound. • Check whether the disc being played has the "5.1 ch" mark on the outside. • Check if your audio system is connected and working properly. • In a SETUP Menu, is the Audio Output set to Bitstream? 	P10-11 P21
The  icon appears on screen.	<ul style="list-style-type: none"> • The features or action cannot be completed at this time because: <ol style="list-style-type: none"> 1. The DVD's software restricts it. 2. The DVD's software doesn't support the feature (e.g., angles). 3. The feature is not available at the moment. 4. You've requested a title or chapter number or search time that is out of range. 	
Disc Menu doesn't appear.	<ul style="list-style-type: none"> • Check if the disc has a Menu. 	
Play mode differs from the Setup Menu selection.	<ul style="list-style-type: none"> • Some of the functions selected in the Setup Menu may not work properly if the disc is not encoded with the corresponding function. 	P19-23
The screen ratio cannot be changed.	<ul style="list-style-type: none"> • The Screen Ratio is fixed on your DVDs. 	P21-22
No audio.	<ul style="list-style-type: none"> • Make sure you have selected the correct Digital Output in the Audio Options Menu. 	P21
The screen is blocked	<ul style="list-style-type: none"> • Press the  button (in front panel) for more than 5 seconds under no disc inside. All settings will revert to the factory settings. 	P12
Forgot password	<ul style="list-style-type: none"> • Press the  button (in front panel) for more than 5 seconds under no disc inside. All settings including the password will revert to the factory settings. Don't use this unless absolutely necessary. 	P22
If you experience other problems.	<ul style="list-style-type: none"> • Go to the contents and find the section of the instruction book that contains the explanations regarding the current problem, and follow the procedure once again. • If the problem still cannot be solved, please contact your nearest authorized service center. 	
The picture is noisy or distorted	<ul style="list-style-type: none"> • Make sure that the disc is not dirty or scratched. • Clean the disc. 	P2

Specifications

General	Power Requirements	AC 110-240 V, 50/60 Hz
	Power Consumption	9 W
	Weight	1.3 Kg
	Dimensions	360mm (W) X 200mm (D) X 37mm (H)
	Operating Temperature Range	+5°C to +35°C
	Operating Humidity Range	10 % to 75 %
Disc	DVD (DIGITAL VERSATILE DISC)	Reading Speed : 3.49 ~ 4.06 m/sec. Approx. Play Time (Single Sided, Single Layer Disc) : 135 min.
	CD : 12Cm (COMPACT DISC)	Reading Speed : 4.8 ~ 5.6 m/sec. Maximum Play Time : 74 min.
	CD : 8Cm (COMPACT DISC)	Reading Speed : 4.8 ~ 5.6 m/sec. Maximum Play Time : 20 min.o)
	VCD : 12Cm	Reading Speed : 4.8 ~ 5.6 m/sec. Maximum Play Time : 74 min. (Video + Audio)
Video Output	Composite Video	1 channel : 1.0 Vp-p (75 Ω load)
Audio Output	*Frequency Response	48 kHz Sampling : 4 Hz to 22 kHz
	*S/N Ratio	96 kHz Sampling : 4 Hz to 44 kHz
	*Dynamic Range	110 dB
	*Total Harmonic Distortion	100 dB
		0.004 %

*: Nominal specification

- Samsung Electronics Co., Ltd reserves the right to change the specifications without notice.
- Weight and dimensions are approximate.

Contact SAMSUNG WORLD WIDE

If you have any questions or comments relating to Samsung products, please contact the SAMSUNG customer care center.

Region	Country	Customer Care Center ☎	Web Site
North America	CANADA	1-800-SAMSUNG(726-7864)	www.samsung.com/ca
	MEXICO	01-800-SAMSUNG(726-7864)	www.samsung.com
	U.S.A	1-800-SAMSUNG(726-7864)	www.samsung.com
Latin America	ARGENTINE	0800-333-3733	www.samsung.com/ar
	BRAZIL	0800-124-421 , 4004-0000	www.samsung.com
	CHILE	800-SAMSUNG(726-7864)	www.samsung.com/cl
	NICARAGUA	00-1800-5077267	
	HONDURAS	800-7919267	
	COSTA RICA	0-800-507-7267	www.samsung.com/latin
	EQUADOR	1-800-10-7267	www.samsung.com/latin
	EL SALVADOR	800-6225	www.samsung.com/latin
	GUATEMALA	1-800-299-0013	www.samsung.com/latin
	JAMAICA	1-800-234-7267	www.samsung.com/latin
	PANAMA	800-7267	www.samsung.com/latin
	PUERTO RICO	1-800-682-3180	www.samsung.com/latin
	REP. DOMINICA	1-800-751-2676	www.samsung.com/latin
	TRINIDAD & TOBAGO	1-800-SAMSUNG(726-7864)	www.samsung.com/latin
VENEZUELA	0-800-100-5303	www.samsung.com/latin	
COLOMBIA	01-8000112112	www.samsung.com.co	
Europe	BELGIUM	0032 (0)2 201 24 18	www.samsung.com/be
	CZECH REPUBLIC	844 000 844 Distributor pro Českou republiku: Samsung Zrt., česká organizační složka Vyskočilova 4, 14000 Praha 4	www.samsung.com/cz
	DENMARK	70 70 19 70	www.samsung.com/dk
	FINLAND	030-6227 515	www.samsung.com/fi
	FRANCE	3260 SAMSUNG (€ 0,15/Min), 08 25 08 65 65 (€ 0,15/Min)	www.samsung.com
	GERMANY	01805 - SAMSUNG(726-7864) (€ 0,14/Min)	www.samsung.com
	HUNGARY	06-80-SAMSUNG(726-7864)	www.samsung.com
	ITALIA	800-SAMSUNG(726-7864)	www.samsung.com
	LUXEMBURG	0035 (0)2 261 03 710	www.samsung.com/be
	NETHERLANDS	0900-SAMSUNG(726-7864) (€ 0,10/Min)	www.samsung.com/nl
	NORWAY	815-56 480	www.samsung.com/no
	POLAND	0 801 801 881 , 022-607-93-33	www.samsung.com/pl
	PORTUGAL	80820-SAMSUNG(726-7864)	www.samsung.com/pt
	SLOVAKIA	0800-SAMSUNG(726-7864)	www.samsung.com/sk
	SPAIN	902 10 11 30	www.samsung.com
	SWEDEN	0771-400 200	www.samsung.com/se
	U.K	0845 SAMSUNG (7267864)	www.samsung.com
EIRE	0818 717 100	www.samsung.com/ie	
AUSTRIA	0800-SAMSUNG(726-7864)	www.samsung.com/at	
SWITZERLAND	0800-SAMSUNG(726-7864)	www.samsung.com/ch	
CIS	RUSSIA	8-800-555-55-55	www.samsung.com
	KAZAHSTAN	8-10-800-500-55-500	www.samsung.kz
	UZBEKISTAN	8-10-800-500-55-500	www.samsung.uz
	KYRGYZSTAN	00-800-500-55-500	
	TADJIKISTAN	8-10-800-500-55-500	
	UKRAINE	8-800-502-0000	www.samsung.com
	LITHUANIA	8-800-77777	www.samsung.lt
	LATVIA	800-7267	www.samsung.com/lv
Asia Pacific	ESTONIA	800-7267	www.samsung.ee
	AUSTRALIA	1300 362 603	www.samsung.com
	NEW ZEALAND	0800SAMSUNG(726-7864)	www.samsung.com/nz
	CHINA	800-810-5858 , 010-6475 1880	www.samsung.com
	HONG KONG	3698-4698	www.samsung.com/hk
	INDIA	3030 8282 , 1800 110011	www.samsung.com
	INDONESIA	0800-112-8888	www.samsung.com
	JAPAN	0120-327-527	www.samsung.com/jp
	MALAYSIA	1800-88-9999	www.samsung.com/my
	PHILIPPINES	1800-10-SAMSUNG(726-7864)	www.samsung.com/ph
	SINGAPORE	1800-SAMSUNG(726-7864)	www.samsung.com
	THAILAND	1800-29-3232 , 02-689-3232	www.samsung.com
TAIWAN	0800-329-999	www.samsung.com/tw	
VIETNAM	1 800 588 889	www.samsung.com	
Middle East & Africa	TURKEY	444 77 11	www.samsung.com
	SOUTH AFRICA	0860-SAMSUNG(726-7864)	www.samsung.com
	U.A.E	800-SAMSUNG (726-7864), 8000-4726	www.samsung.com



Contact SAMSUNG WORLD WIDE

If you have any questions or comments relating to Samsung products,
please contact the SAMSUNG customer care centre.

☎ 1800-88-9999/ www.samsung.com/my