

**SAMSUNG**

# OWNER'S INSTRUCTIONS

**INDOOR UNIT**

**FH18ETA1**

**FH24ETA1**

**OUTDOOR UNIT**

**FH18ETX1**

**FH24ETX1**

**System Air Conditioner (Cooling and Heating)**

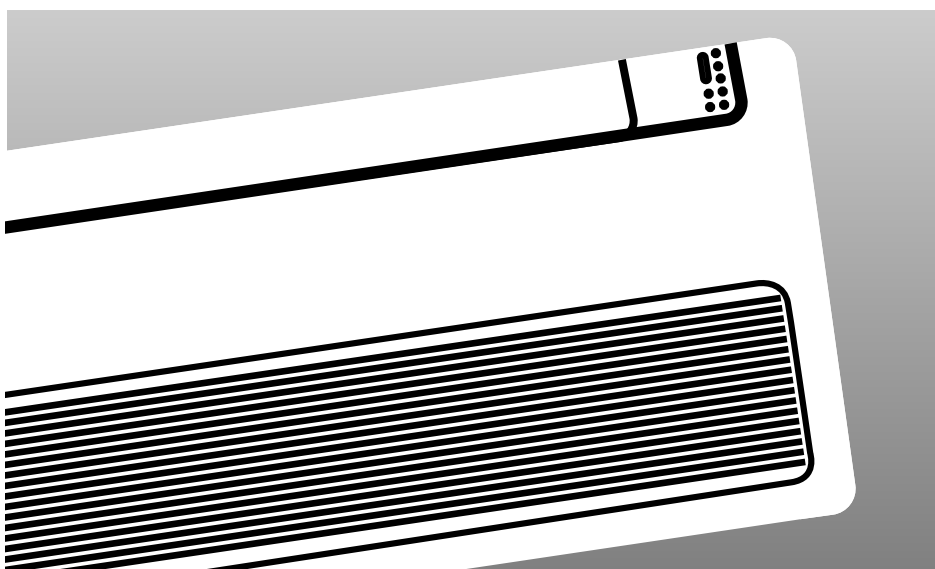

Register your product at [www.samsung.com/global/register](http://www.samsung.com/global/register)

## Safety Precautions

The following safety precautions must be taken when using your air conditioner.



### WARNING

Risk of electric shock. • Can cause injury or death. • Disconnect all remote electric power supplies before servicing, installing or cleaning. • This must be done by the manufacturer or its service agent or a similar qualified person in order to avoid a hazard.

#### DURING OPERATION

- ◆ Users of this product are cautioned not to attempt repair of this product at their own discretion. Instead, they are requested to directly contact a designated service center or the outlet at which the product was purchased.
- ◆ Never spill any kind of liquid into the unit. Should this happen, unplug or main switch off the unit and contact an authorized service center.
- ◆ Do not insert anything between the air outlet blades because the inner fan may be damaged and could cause injury. Keep children away from the unit.
- ◆ Do not place any obstacles in front of the unit.
- ◆ Do not spray liquid of any kind into the indoor unit. Should this happen, switch off the breaker used for your air conditioner and contact your installation specialist.
- ◆ Make sure that the unit is correctly ventilated at all times: Do not place clothing or other materials over it.
- ◆ If the wireless remote control will not be used for a long time, remove the batteries. (If applicable)
- ◆ When using a wireless remote control, the distance should not be more than 7 meters from the air conditioner. (If applicable)

#### DISPOSING OF THE UNIT

- ◆ Before throwing out the device, it is necessary to pull back the battery cells and get rid of them safely for recycling reasons.
- ◆ When you need to dispose of the unit, consult your dealer. If pipes are removed incorrectly, refrigerant may blow out and come into contact with your skin, causing injury. Releasing refrigerant into the atmosphere also damages the environments.
- ◆ Please recycle or dispose of the packaging material for this product in an environmentally responsible manner.

#### OTHERS

- ◆ Never store or ship the air conditioner upside down or sideways to avoid damage to the compressor.
- ◆ The appliance is not intended for use by young children or infirm persons without supervision: Young children should be supervised to ensure that they do not play with the appliance.
- ◆ Max current is measured according to IEC standard for safety and current is measured according to ISO standard for energy efficiency.

# Contents

---

- ◆ **PREPARING YOUR AIR CONDITIONER**
  - Safety Precautions ..... 2
  - View of the Unit ..... 4
  - Wireless Remote Controller-Buttons and Display ..... 6
  - Wired Remote Controller-Buttons and Display ..... 7
  - Centralized Controller ..... 8
  - Function Controller ..... 9
  
- ◆ **RECOMMENDATIONS FOR USE**
  - Adjusting the Air Flow Direction ..... 10
  - Operating Recommendations ..... 11
  - Temperature and Humidity Ranges ..... 12
  - Cleaning Your Air Conditioner ..... 13
  - Solving Common Problems ..... 14
  
- ◆ **TECHNICAL SPECIFICATIONS**

## View of the Unit

The figures are shown in this instruction may differ from yours depending on the model.

### Indoor Unit

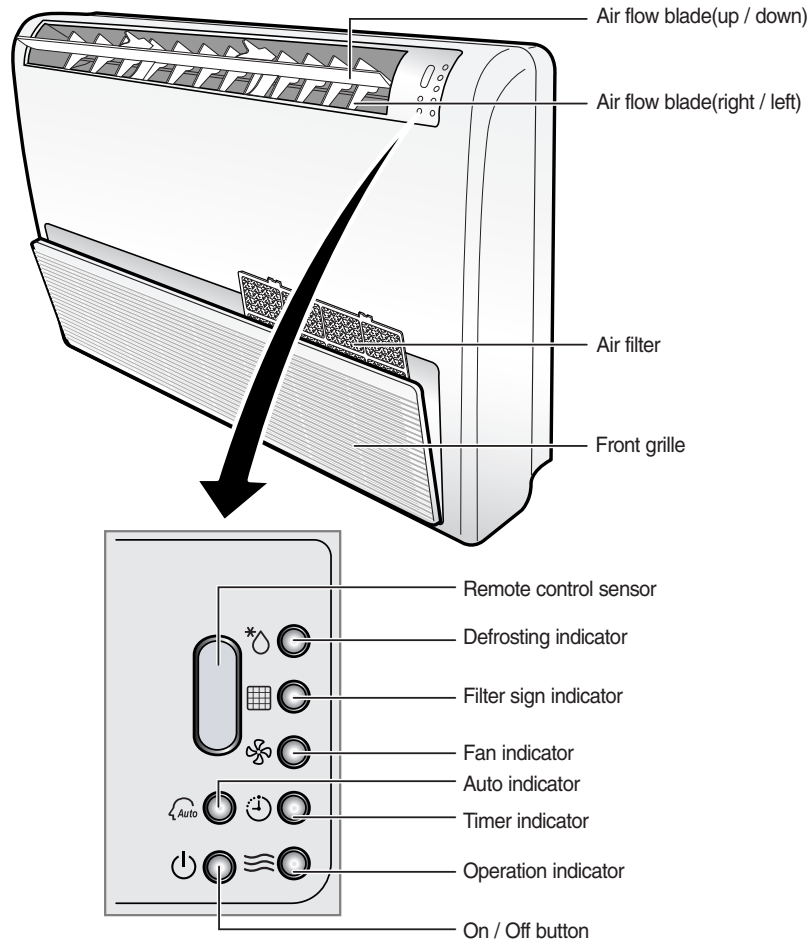

## Outdoor Unit

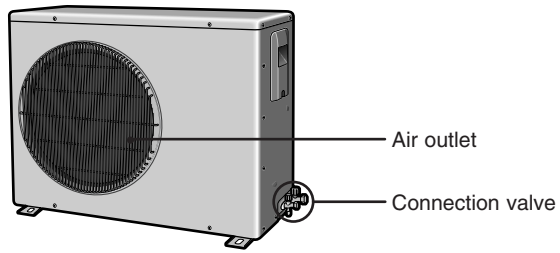

- Note** ◆ If the heat exchanger in the outdoor unit gets dusty, cooling efficiency may fall.  
So clean the heat exchanger with water when it becomes dirty. However, be careful when you wash the surface of the heat exchanger because it is very sharp.

## Wireless Remote Controller-Buttons and Display

To use the wireless remote controller, refer to an appropriate manual.

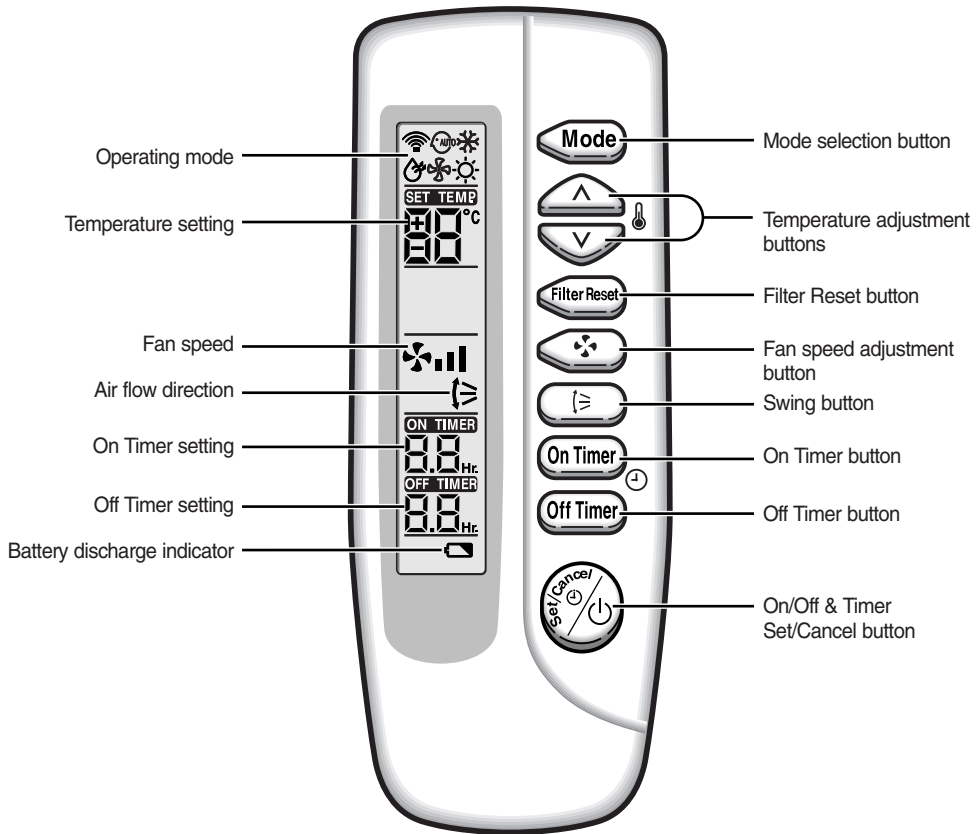

**Note** ◆ After cleaning the air filter, press the  button.

## Wired Remote Controller-Buttons and Display

The wired remote controller is an optional accessory and it is installed on the wall.  
To use the wired remote controller, refer to an appropriate manual.

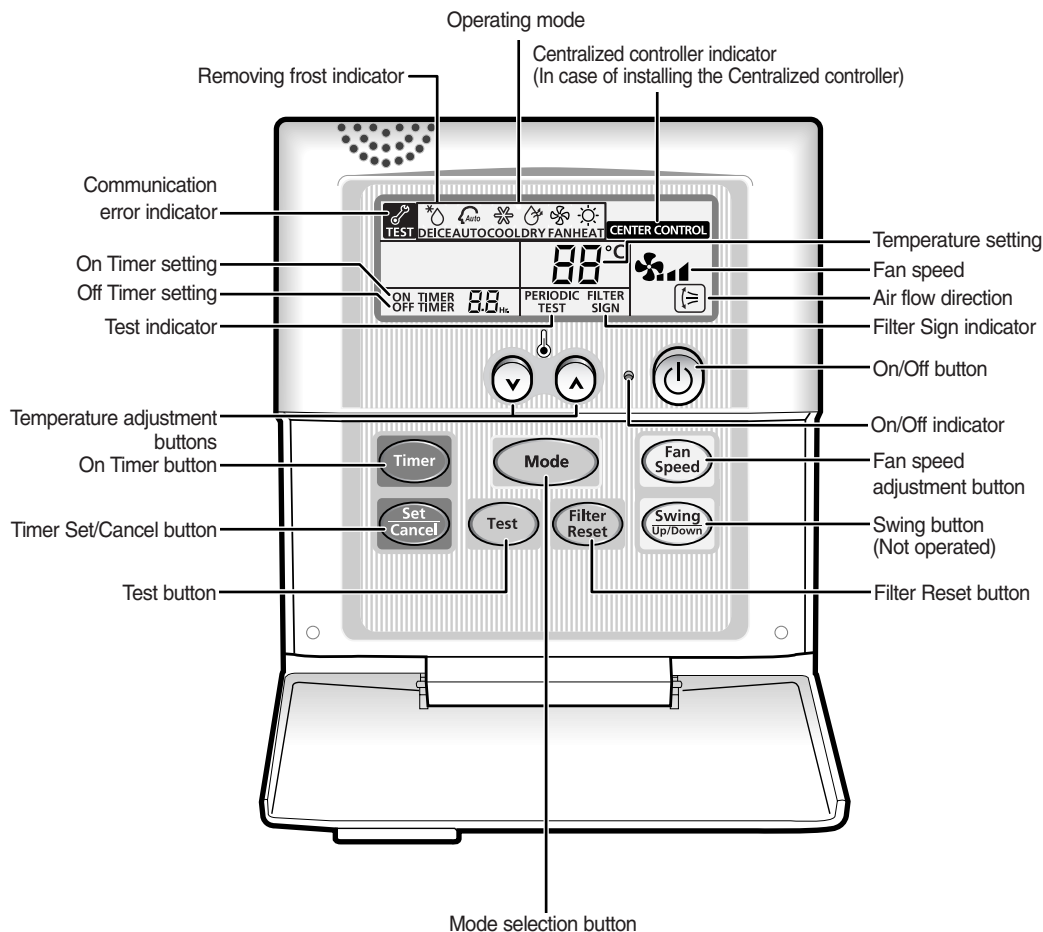

- Note**
- ◆ The **Test** button is for your installation specialist. You must NOT press it.
  - ◆ After cleaning the air filter, press the **Filter Reset** button. Then the wired remote controller will display the FILTER SIGN indicator when the time to clean the air filter; refer to page 13.

## Centralized Controller

The centralized controller is an optional accessory and it is installed on the wall.  
To use the centralized controller, refer to an appropriate manual.

### Front View

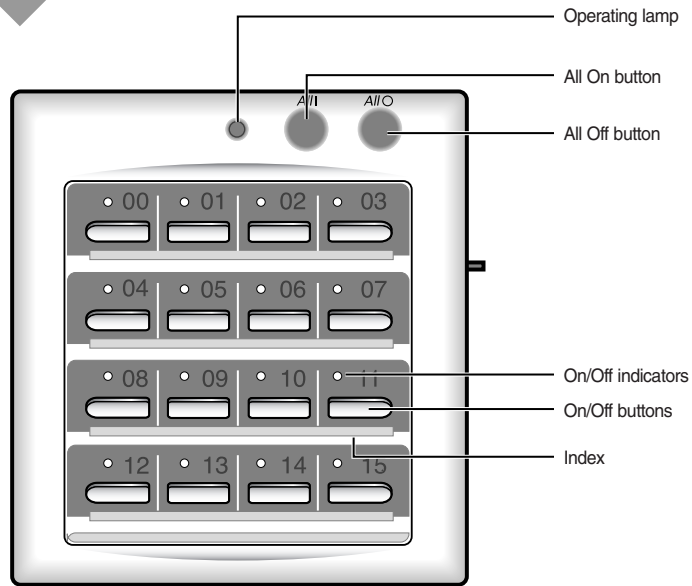

**Note** ♦ The operating lamp comes on even when only one air conditioner connected to the centralized controller is operating.

### Side View

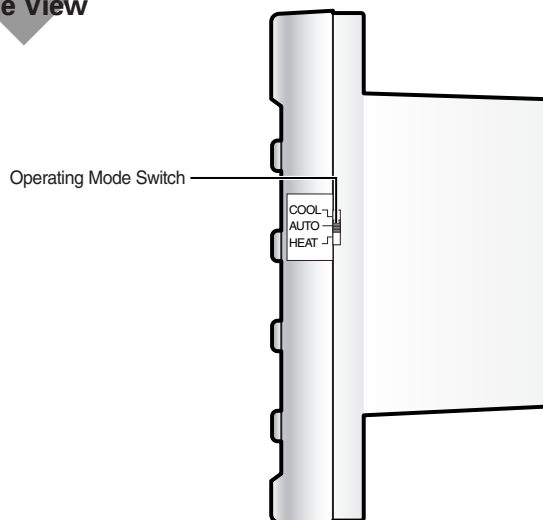

**Note** ♦ Choose the appropriate operating mode with the Operating Mode Switch that enables the user to choose between the Cool/Auto/Heat mode.



## Function Controller

The function controller is an optional accessory and it is installed on the wall.  
 The function controller is an additional controller which is used with the centralized controller.  
 To use the function controller, refer to an appropriate manual.

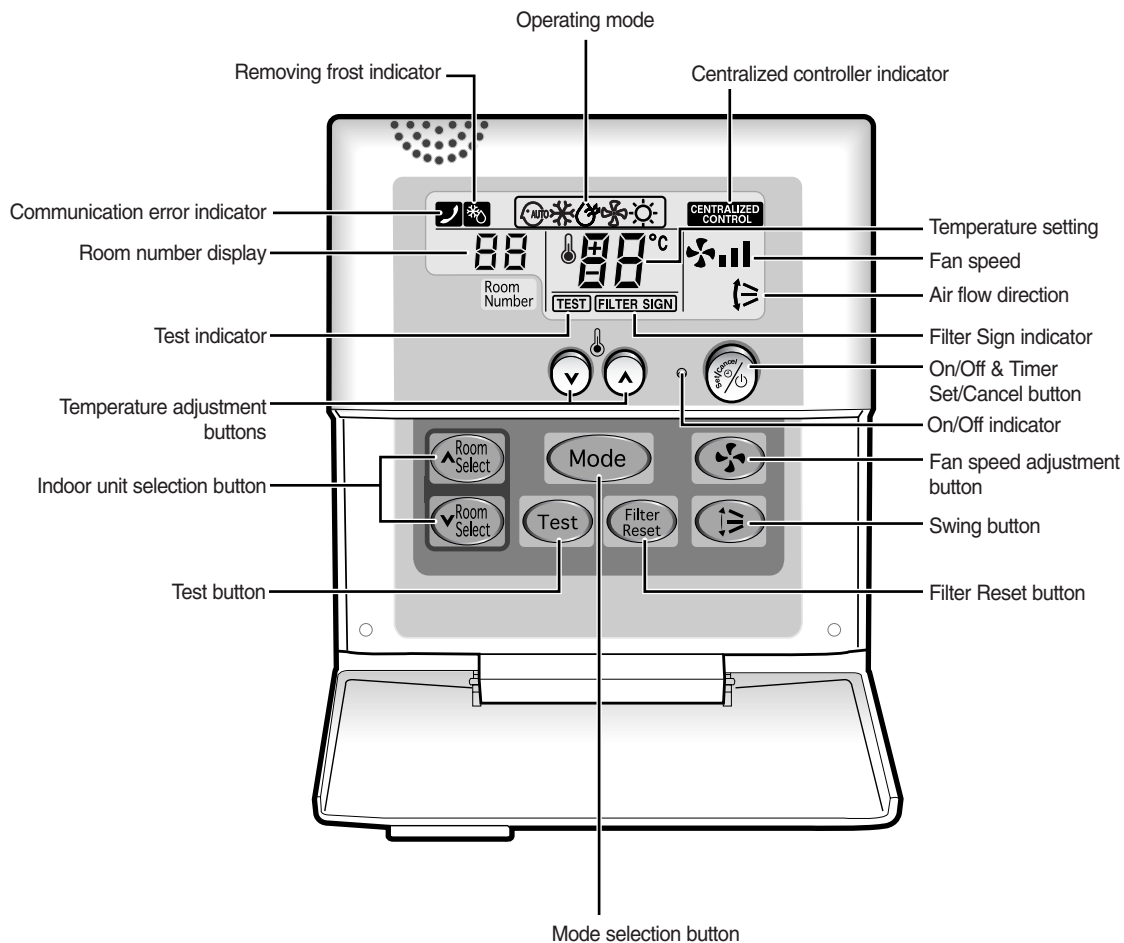

- Note**
- ◆ The **Test** button is for your installation specialist. You must NOT press it.
  - ◆ After cleaning the air filter, press the **Filter Reset** button. Then the wired remote controller will display the FILTER SIGN indicator when the time to clean the air filter.

## Adjusting the Air Flow Direction

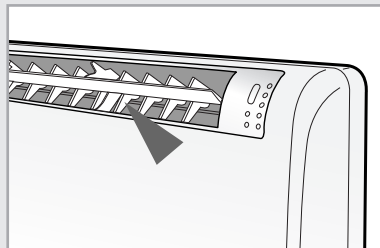

**There are two sets of inner air flow blades. Just as the outer air flow blade can be adjusted vertically, the inner blades can be adjusted horizontally.**

---

Adjust each set of inner blades to the required position, by pushing or pulling them sideways.

---

## Operating Recommendations

Here are a few recommendations that you should follow when operating your air conditioner.

Topic	Recommendation
Heating performances	The heat pump function of the air conditioner absorbs heat from outside air and brings it indoors. As the temperature of the outside air drops, the heating performance of air conditioner will decrease. If you find that the room is not warm enough, using an additional heating appliance is recommended.
Frost	<p>When outside temperature is low but humidity is high, frost may form on the outdoor unit at HEAT mode.</p> <p>If this happens:</p> <ul style="list-style-type: none"><li>◆ The heating operation stops.</li><li>◆ The defrost mode will be triggered automatically for about 10 minutes.</li></ul> <p>No intervention is required ; after about 10 minutes, the air conditioner operates again normally.</p>
High indoor and outdoor temperatures	<p>If both indoor and outdoor temperatures are high and the air conditioner is running at HEAT mode, the outdoor unit's fan and compressor may stop at times.</p> <p>This is normal ; simply wait until the air conditioner switches on again.</p>
Power failure	If a power failure occurs while the air conditioner is operating, the unit will be switched off. When the power returns, the air conditioner starts up again automatically.

## Temperature and Humidity Ranges

The following table indicates the temperature and humidity ranges, within which the air conditioner can be used.

If the air conditioner is used at...	Then...
High temperature	The automatic protection feature may be triggered and the air conditioner stopped.
Low temperature	A water leakage or some other malfunction may happen if the heat exchanger freezes.
High humidity levels	Water may condense on and drip from the surface of the indoor unit if it is used for a long periods.

Mode	Outdoor Temperature	Indoor Temperature	Indoor Humidity
Heating	-5°C to 24°C approx.	27°C or less	-
Cooling	-5°C to 54°C approx.	21°C to 32°C approx.	80% or less
Drying	-5°C to 54°C approx.	21°C to 32°C approx.	-

※ The standardized temperature for heating is 7°C.  
If the outdoor temperature drops to 0°C or below, the heating capacity can be reduced depending on the temperature condition.

If the cooling operation is used at over 32°C(indoor temperature), it does not cool at its full capacity.

## Cleaning Your Air Conditioner

To get the best possible use out of your air conditioner, you must to clean it to remove the dust that accumulates on the air filters.

**IMPORTANT** Before cleaning your air conditioner, ensure that you have switched off the breaker used for the unit.

- 1 Open the front grille by pushing on both sides and center.
- 2 Pull the air filters in upward direction to remove them. Remove all dust from the air filters by vacuum cleaner, brush or by washing them with a detergent and warm water below 40°C. After washing, allow them to dry thoroughly in an area protected from sunlight.
- 3 Insert the air filters to the front grille.
- 4 Close the front grille by pushing both sides and center.

- Note**
- ◆ If you have not used the air conditioner for a long period of time, set the fan going for three or four hours to dry the inside of the air conditioner thoroughly.
  - ◆ If you don't clean the air filter at least every two weeks, its performance may be reduced and noise may increase.
  - ◆ After cleaning the air conditioner, press the Filter Reset button.

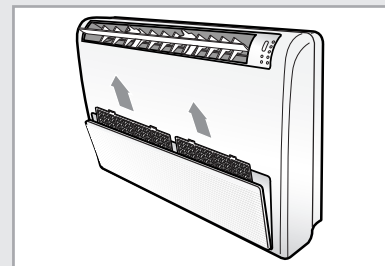

Wired Remote Controller

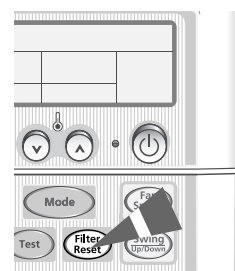

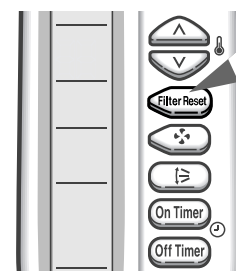

Wireless Remote Controller



## Solving Common Problems

**Before contacting the after-sales service, perform the following simple checks. They may save your time and expense of an unnecessary call.**

Problem	Explanation/Solution
The air conditioner does not operate at all	<ul style="list-style-type: none"> <li>◆ Check that the breaker used for the air conditioner is switched on.</li> </ul>
<b>Wired Remote Controller</b>	
The air conditioner does not operate with the remote controller	<ul style="list-style-type: none"> <li>◆  is displayed on the wired remote controller. In this case, turn the air conditioner off and contact your dealer.</li> </ul>
<b>Wired Remote Controller</b>	
When turning on/off the air conditioner, it is not turned on/off immediately.	<ul style="list-style-type: none"> <li>◆ In case of using the wired remote controller for a group, the air conditioners connected to the remote controller are turned on/off in order. Thus, it takes some time (up to 32 seconds).</li> </ul>
<b>Wireless Remote Controller</b>	
The air conditioner does not operate with the remote controller	<ul style="list-style-type: none"> <li>◆ Check that there are no obstacles between you and the remote control sensor.</li> <li>◆ Check the wireless remote controller batteries.</li> <li>◆ Check that you are close enough to the remote control sensor. (7 metres/yards or less).</li> </ul>
<b>Wireless Remote Controller</b>	
No beep is heard when you press  (On/Off) on the remote controller	<ul style="list-style-type: none"> <li>◆ Check that you are pointing the remote controller at the remote control sensor on the indoor unit.</li> <li>◆ Replace the remote controller batteries if necessary.</li> <li>◆ If there is a strong light around the air conditioner, a three-wavelength light, a neon sign, etc., for example, the air conditioner may not be operated with a remote controller. If this happens, use the remote controller close by the remote control sensor.</li> </ul>
The air conditioner does not cool or heat	<ul style="list-style-type: none"> <li>◆ Check that the correct operating mode has been selected.</li> <li>◆ The room temperature may be too low or too high.</li> <li>◆ Dust may be blocking the air filter guard; refer to page 13 for cleaning instructions.</li> <li>◆ Check that there is no obstacle in front of the outdoor unit.</li> </ul>
When heating, the required room temperature is never reached and the air conditioner frequently stops	<ul style="list-style-type: none"> <li>◆ Check that the required temperature has been set correctly.</li> <li>◆ Increase the fan speed.</li> </ul>

## Technical Specifications

Model	Power Supply
FH18ETA1 FH24ETA1	1Ø, 220-240V~, 50Hz



### Contact SAMSUNG WORLD WIDE

If you have any comments or questions regarding a Samsung products, contact the SAMSUNG customer care center.

<b>COUNTRY</b>	<b>Customer Care Center</b> 📞	<b>Web Site</b>
TURKEY	444 77 11	<a href="http://www.samsung.com">www.samsung.com</a>
SOUTH AFRICA	0860-SAMSUNG(726-7864 )	<a href="http://www.samsung.com">www.samsung.com</a>
U.A.E	800-SAMSUNG (726-7864) 8000-4726	<a href="http://www.samsung.com">www.samsung.com</a>

© Samsung Electronics Co., Ltd. All Rights Reserved.