



features of your new air conditioner

- **Cool Summer Offer**

On those hot sweltering summer days and long restless nights, there is no better escape from the heat than the cool comforts of home. Your new air conditioner brings an end to exhausting hot summer days and lets you rest. This summer, beat the heat with your own air conditioner.

- **A Look for Everywhere**

The elegant and harmonious design gives priority to the esthetics of your space and complements any of your existing interior décor. With its soft color and rounded-edge shape, the new air conditioner adds class to any room. Enjoy what your air conditioner offers both functionally and esthetically.

- **Compact and easy-to-use Cassette type**

Designed to be installed into most types of suspended ceiling, the cassette type air conditioner is ideal for business and commercial accommodations. Fresh cool/warm air can be provided through the controllable 1, 2 or 4 sides of the unit. All functions of the air conditioner will be controlled easily via a remote control.



For easy future reference write the model and serial number down. You will find your model number on the right side of the air conditioner.

Model # _____

Serial # _____

safety information











To prevent electric shock, disconnect the power before servicing, cleaning, and installing the air conditioner.

SAFETY INFORMATION

Before using your new air conditioner, please read this manual thoroughly to ensure that you know how to safely and efficiently operate the extensive features and functions of your new appliance.

Because the following operating instructions cover various models, the characteristics of your air conditioner may differ slightly from those described in this manual. If you have any questions, call your nearest contact center or find help and information online at www.samsung.com.

Important safety symbols and precautions:

 WARNING	Hazards or unsafe practices that may result in severe personal injury or death.
 CAUTION	Hazards or unsafe practices that may result in minor personal injury or property damage.
 CAUTION	To reduce the risk of fire, explosion, electric shock, or personal injury when using your air conditioner, follow these basic safety precautions:
	Do NOT attempt.
	Do NOT disassemble.
	Do NOT touch.
	Follow directions carefully.
	Unplug the power plug from the wall socket.
	Make sure the machine is grounded to prevent electric shock.
	Call the contact center for help.
	Note.

These warning signs are here to prevent injury to you and others.

Please follow them carefully.

After reading this section, keep it in a safe place for future reference.

safety information

SEVERE WARNING SIGNS

 **Do not place the air conditioner near hazardous substances or equipment that releases free flames to avoid fire, explosions or injuries.**

- Potential risk of fire hazard or explosion.

Do not install the outdoor unit at an unstable place or elevated surface where there is potential risk of falling.

- If the outdoor unit falls, it may cause personal injury or loss of property.

Failure or damage may occur if any changes or modification that is not stated in the installation manual was performed. In this case, user will be responsible for the repair expenses.

Install the air conditioner away from direct exposure to sunlight, heating apparatus, and humid places.

- Hang curtains on windows to boost cooling efficiency and to avoid the risk of electric shock.

Do not cut the power plug and connect to a different power cable.

Do not yank the power cable and touch the power plug with hands.

- Potential risk of fire or electric shock.

Never use a damaged or dusted power plug, power cable, or loosened power receptacle.

- Potential risk of fire or electric shock.

Install an exclusive circuit breaker and short-circuit breaker for the air conditioner.

- Potential risk of electric shock or fire.

Do not insert anything such as fingers or branches into the air conditioner vents while the air conditioner is running.

- Keep the children away from the air conditioner to prevent them from putting their finger on the air conditioner. Potential risk of personal injury.

Ensure no water gets into the air conditioner.

- Potential risk or electric shock.
- If the water gets into the air conditioner, stop and unplug the power source immediately.

Turn off the air conditioner using the provided remote control or control accessory (if provided). Do not unplug to turn off the unit (unless there is an immediate danger).

Do not run the air conditioner for an extended period of time in a room with the door closed or with babies, elderly or disabled people.

- Open the door or windows to ventilate your room at least once an hour to prevent oxygen shortage.

The air conditioner is composed of moving parts. Keep children away from the unit to avoid physical injury.

-  **Make sure that children take precautions against access to the air conditioner and they do not play with the unit.**

Do not clean the interior of air conditioner on your own.

- You may damage the parts which can cause electric shock or fire.
- Consult contact center for cleaning the interior of the air conditioner.

-  **Do not connect the air conditioner with heating apparatus or attempt to disassemble, remodel or repair it yourself.**

- Potential risk of malfunction, electric shock or fire. If repairs are needed, consult the contact center.

-  **Consult the place of purchase or contact center to install, reinstall or disassemble the air conditioner.**

- Improper installation carries a risk of unit malfunction, water leakage, electric shock or fire.
- If installing in specialty areas, such as a factory complex or saline coastal area, consult the place of purchase or contact center for specific installation details.
- The units must be installed according to distances declared, in order to permit accessibility from each side, either to guarantee correct operation of maintenance or repairing products. The unit's parts must be reachable and removable completely under safety condition (for people or things).

Consult a dealer regarding the appropriate measures to prevent the allowable concentration from being exceeded.

- If the refrigerant leaks, and cause the concentration limit to be exceeded, hazards due to lack of oxygen in the room may result.

If the indoor unit gets wet, turn the power off immediately and call your nearest contact center.

- Potential risk of fire or electric shock.

Always make sure that the power supply is compliant with current safety standards. Always install the air conditioner in compliance with current local safety standards.

Verify that the voltage and frequency of the power supply comply with the specifications and that the installed power is sufficient to ensure the operation of any other domestic appliance connected to the same electric lines.

Use a rated circuit breaker only.

- Never use steel wires or copper wires as a circuit breaker. It may cause fire or unit malfunctions.

Do not put undue stress or place heavy object on the power cable.

Do not bend the power cable excessively.

- Potential risk of fire or electric shock.

To protect the product from water and possible shock, you should keep the power cable and the connection cord of the indoor and outdoor units in the protection tube.

When opening or closing the front panel, use a stable stool and watch your steps carefully.

-  **Disconnect the air conditioner from power supply before it is repaired or disassembled.**

Clean the air conditioner after the inner fan stops operating.

- Potential risk of injury or electric shock.

safety information

SEVERE WARNING SIGNS (CONT'D)

 **Use a receptacle that has a ground terminal. The receptacle must be used exclusively for the air conditioner.**

- Improper electrical grounding may cause electric shock or fire.

Be sure to ground the unit. Do not connect the ground wire to gas or water pipes, lighting rods, or telephone grounding lines.

- If the unit is not properly grounded, electric shock may result.

 **If you smell burning plastic, hear strange sounds, or see smoke coming from the unit, unplug the air conditioner immediately and call a contact center.**

- Potential risk of fire or electric shock.

CAUTION SIGNS

 **Do not block or place items in front of the air conditioner. Do not step, hang onto, or place heavy items on the air conditioner.**

- Potential risk of personal injury.

If failure or damage occurs on the conditions of improper use not followed by the installation manual, there will be an extra labor charge for installing and construction.

- Potential risk of malfunction, electric shock or fire if repairs or installations are attempted by a non-qualified service technician.

Do not spray flammable gases such as insecticide near the air conditioner.

- Potential risk of electric shock, fire or unit malfunction.

Do not open the front grille during operation.

- Potential risk of electric shock or unit malfunction.

Cool air should not flow directly towards people, pets, and plants.

- It is harmful to your health, pets, and plants.

Do not drink drain water coming out of the air conditioner.

- Potential risk of health hazard.

Do not allow children to climb on the air conditioner.

Do not use the air conditioner as a cooling precision instrument for food, pets, plants, cosmetics or machinery.

Do not pull or give excessive shock to the air conditioner.

- Potential risk of fire, or unit malfunction and there are risk of personal injury because unit may fall down.

Do not spray water directly on the air conditioner or use benzene, thinner or alcohol to clean the surface of the unit.

- Potential risk of electric shock or fire.
- Potential risk of damage to the air conditioner.

Do not place any objects, especially containers with liquid.



Do not touch the pipe connected to the air conditioner.



Install the indoor unit away from lighting apparatus using the ballast.

- If you use the wireless remote control, reception error may occur due to the ballast of the lighting apparatus.

Install the outdoor unit where operating noise and vibration will not disturb your neighbor and in a well-ventilated area with no obstacle.

- Potential risk of malfunction.
- Operating noise may disturb your neighbor.

Make sure that there are no obstacles or covers that block the air conditioner.

Allow sufficient space for air circulation.

- Insufficient ventilation may result in poor performance.

If the power cable is damaged, the manufacturer or a qualified service technician must replace it.

If a power outage occurs while the air conditioner is working, turn off the power source immediately.

Max current is measured according to IEC standard for safety and current is measured according to ISO standard for energy efficiency.

Check for damage on delivery. If damaged, do not install the air conditioner and call the place of purchase immediately.

Keep indoor temperatures stable and not extremely cold, especially where there are children, elderly or disabled people.

The packaging material and used batteries of the remote controller (optional) must be disposed of in accordance with the national standards.

The refrigerant used in the air conditioner must be treated as chemical waste. Dispose the refrigerant following national standards.

Have a qualified service technician install the air conditioner and perform a trial operation.

Firmly connect the drain hose to the air conditioner for proper water drainage.

Check for damages on the outdoor unit installation pad at least once a year.

- Potential risk of personal injury or property loss.

When using a wireless remote control, the distance should not be more than 7 meters from the air conditioner.

If the remote control is not used for a long period of time, remove the batteries to prevent leakage of electrolyte.

When cleaning the outdoor unit, touch the heat exchanger radiator fins with extreme care.

- Wearing thick gloves can protect your hands.

Make sure that the condensed water dripping from the drain hose runs out properly and safely.

The appliance is not intended for use by persons (including children) with reduced physical, sensory or mental capabilities, or lack of experience and knowledge, unless they have been given supervision or instruction concerning use of the appliance by a person responsible for their safety: Young children should be supervised to ensure that they do not play with the appliance.

safety information

CAUTION SIGNS (CONT'D)

-  Inspect the condition, electric connections, pipes and external case of the air conditioner regularly by a qualified service technician.

Do not open doors and windows in the room being cooled during operation unless necessary.

Do not block the air conditioner vents. If objects block the air flow, it may cause unit malfunction or poor performance.

Make sure there are no obstacles under the indoor unit.

- Potential risk of fire or loss of property.

The air conditioner should be used only for the applications for which it has been designed: the indoor unit is not suitable to be installed in areas used for laundry.

Our units must be installed in compliance with the spaces indicated in the installation manual to ensure either accessibility from both sides or ability to perform routine maintenance and repairs. The units' components must be accessible and that can be disassembled in conditions of complete safety either for people or things.

For this reason, where it is not observed as indicated into the Installation Manual, the cost necessary to reach and repair the unit (in safety, as required by current regulations in force) with slings, trucks, scaffolding or any other means of elevation won't be considered in-warranty and charged to end user.

-  Ensure the off-on and protection switches are properly installed.

Do not use the air conditioner if damaged. If problems occur, immediately stop operation and disconnect the plug from the power supply.

If the air conditioner will not be used for an extended period of time (for example, over several months), unplug the power from the wall.

-  Call the place of purchase or a contact center if repairs are needed.

- Potential risk of fire or electric shock if disassembly or repairs are attempted by a non-qualified service technician.

contents

VIEWING YOUR AIR CONDITIONER 10 4 way cassette

10

USING YOUR AIR CONDITIONER 11 Tips on using your air conditioner

11

**CLEANING AND MAINTAINING
THE AIR CONDITIONER** 12 Cleaning the exterior
13 Cleaning the grille
14 Cleaning the filter
15 Maintaining your air conditioner
15 Periodical checks
16 Internal protections via the unit control
system

12

APPENDIX 17 Troubleshooting
18 Operation ranges

17

viewing your air conditioner

Congratulations on the purchase of the air conditioner. We hope you enjoy the features of your air conditioner and stay cool or warm with optimal efficiency.

Please read the user manual to get started and to make the best use of the air conditioner.

4 WAY CASSETTE

Main parts

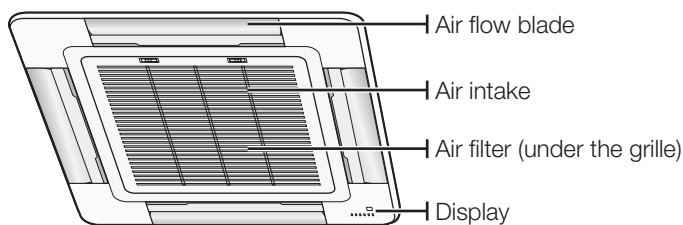

Display

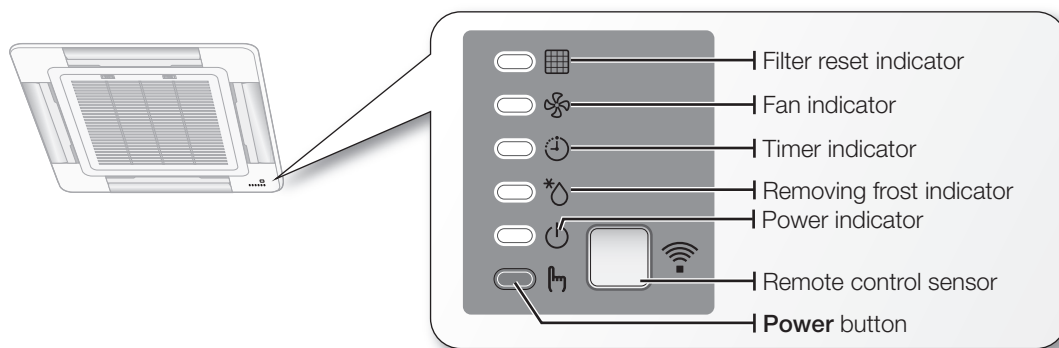

 Your air conditioner and display may look slightly different from the illustration shown above depending on your model.

using your air conditioner

TIPS ON USING AIR CONDITIONER

Here are some tips that you would follow when using your air conditioner.

TOPIC	RECOMMENDATION
Cooling	<ul style="list-style-type: none">• If current outside temperatures are much higher than the selected indoor temperature, it may take time to bring the inner temperature to the desired coolness.• Avoid drastically turning down the temperature. Energy is wasted and the room does not cool faster.
Power failure	<ul style="list-style-type: none">• If a power failure occurs during the operation of the air conditioner, the operating immediately stops and unit will be off. When power returns, the air conditioner will run automatically.
Protection mechanism	<ul style="list-style-type: none">• If the air conditioner has just been turned on after operation stops or being plugged in, cool/warm air does not come out for 3 minutes to protect the compressor of the outdoor unit.

cleaning and maintaining the air conditioner

For the best performance from your air conditioner, clean it periodically. When cleaning, make sure to unplug from the unit for user's safety.

CLEANING THE EXTERIOR

- When cleaning the exterior, make sure to unplug the power from the unit. No special tools are needed to clean it.
- Wipe the surface of the unit with a slightly wet or dry cloth when needed. Wipe off dirt of odd-shaped area by using a soft brush.

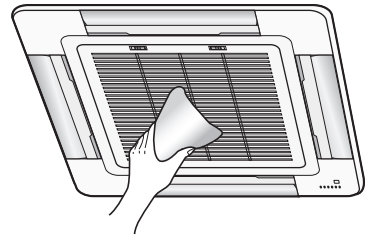

Do not use Benzene or Thinner. They may damage the surface of the air conditioner and can create a risk of fire.

CLEANING THE GRILLE

When cleaning the grille, make sure to unplug the power from the unit. No special tools are needed to clean it.

1. Open the front grille.

Push both of the tabs outwards to unlock the hook on the front grille. The grille automatically drops. Two safety clips are mounted to the inside front grille to prevent dropping downward.

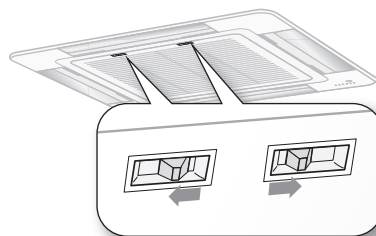

2. Unhook the safety clips by holding the front grille.

3. Detach the front grille.

Hold the front grille at a 45° angle, lift it up slightly and then pull the grille forward.

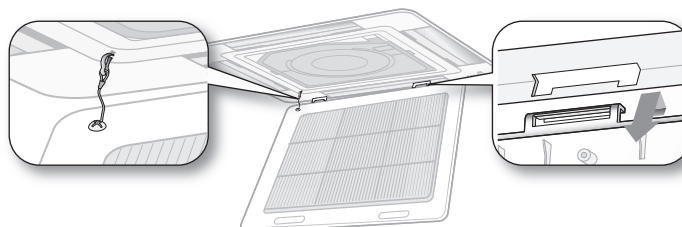

 **CAUTION** Hold the grille to prevent dropping outside from the opening of the front grille. If not, it may cause a potential risk of personal injury.

 Cleaning the grille is also available while being attached to the panel.

4. Pull out the Air filter.

Grab the Air filter and lift it upwards while pushing slightly, and then pull the Air filter forward.

5. Clean the grille with a vacuum cleaner or soft brush. If dust is too heavy, then rinse it with running water and dry it in a ventilated area.

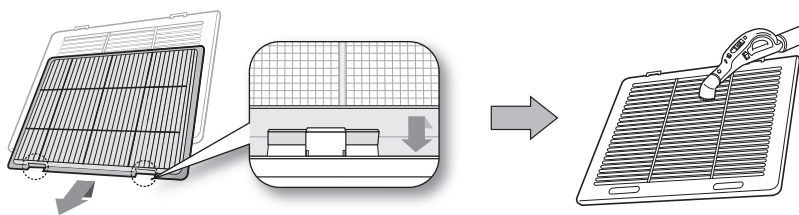

6. Insert the Air filter back in its original position.

You will hear a click sound when the Air filter is properly placed.

7. Reattach the front grille.

Place the hook on the unit to the right place then push the front grille upward. Mount the safety clips to its original position.

 The illustration shown above may differ from yours depending on your model.

cleaning and maintaining the air conditioner

CLEANING THE FILTER

When cleaning the filter, make sure to unplug the power from the unit. Washable foam based Air filter captures large particles from the air. The filter is cleaned with a vacuum or by hand washing.

1. Push both of the tabs outwards to unlock the hook on the front grille.

The grille automatically drops. Two safety clips are mounted to the inside front grille to prevent dropping downward.

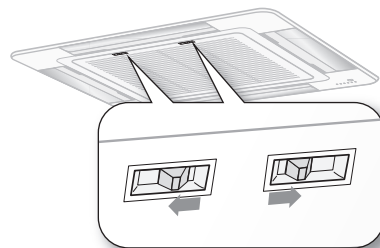

2. Pull out the Air filter.

Grab the Air filter and lift it upwards while pushing slightly, and then pull the Air filter forward.

-  When cleaning the filter you do not need to detach the grille at all times. If you want to detach the front grille, see step 2 and 3 on page 16 for instructions.

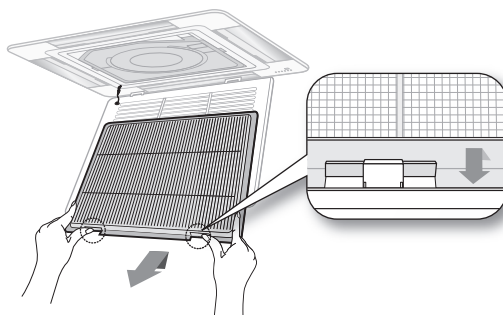

3. Clean the Air filter with a vacuum cleaner or soft brush. If dust is too heavy, then rinse it with running water and dry it in a ventilated area.

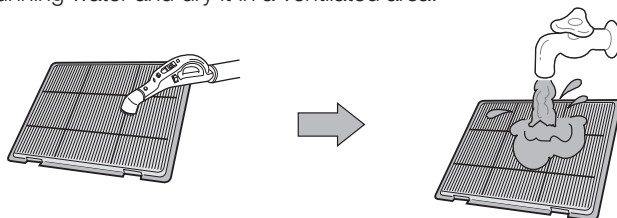

-  • For best conditions, repeat every two weeks.
• If the Air filter dries in a confined (or humid) area, odors may generate. If it occurs, re-clean and dry it in a well-ventilated area.

4. Insert the Air filter back in its original position.

You will hear a click sound when the Air filter is properly placed.

5. Close the front grille by pushing it upward.

-  • The illustration shown above may differ from yours depending on your model.
• After cleaning the filter, press the **Filter Reset** button on the remote control for 2 seconds to reset the filter schedule. Filter sign indicator will be on for cleaning time.

cleaning and maintaining the air conditioner

MAINTAINING YOUR AIR CONDITIONER

If the air conditioner will not be used for an extended period of time, dry the air conditioner to maintain it in best condition.

1. Dry the air conditioner thoroughly by operating in Fan mode for 3 to 4 hours and disconnect the power plug. There may be internal damage if moisture is left in components.
2. Before using the air conditioner again, dry the inner components of the air conditioner again by running in Fan mode for 3 to 4 hours. This helps remove odors which may have generated from dampness.

Periodical checks

Refer to the following chart to maintain the air conditioner properly.

Type	Description	Monthly	Every 4 months	Once a year
Indoor unit	Clean the air filter (1)	●		
	Clean the condensate drain pan (2)			●
	Thoroughly clean the heat exchanger (2)			●
	Clean the condensate drain pipe (2)		●	
	Replace the remote control batteries (1)			●
Outdoor unit	Clean the heat exchanger on the outside of the unit (2)		●	
	Clean the heat exchanger on the inside of the unit (2)			●
	Clean the electric components with jets of air (2)			●
	Verify that all the electric components are firmly tightened (2)			●
	Clean the fan (2)			●
	Verify that all the fan assembly is firmly tightened (2)			●
	Clean the condensate drain pan (2)			●

 The checks and maintenance operations described are essential to guarantee the efficiency of the air conditioner. The frequency of these operations varies according to the characteristics of the area, the amount of dust, etc.

- (1) The described operations should be performed more frequently if the area of installation is very dusty.
- (2) These operations must always be performed by qualified personnel. For more detailed information, see the Installation Manual.

cleaning and maintaining the air conditioner

MAINTAINING YOUR AIR CONDITIONER

Internal protections via the unit control system

This internal protection operates if an internal fault occurs in the air conditioner.

Type	Description
Anti-protection of internal battery	The compressor will be off to protect internal battery when the air conditioner operates in Cool mode.
Protect compressor	The air conditioner does not start operating immediately to protect the compressor of the outdoor unit after it has been started.

appendix

TROUBLESHOOTING

Refer to the following chart if the air conditioner operates abnormally. This may save time and unnecessary expenses.

PROBLEM	SOLUTION
The air conditioner does not operate immediately after it has been restarted.	<ul style="list-style-type: none"> Because of the protective mechanism, the appliance does not start operating immediately to keep the unit from overloading. The air conditioner will start in 3 minutes.
The air conditioner does not work at all.	<ul style="list-style-type: none"> Check that the power plug is properly connected. Insert the power plug into the wall socket correctly. Check if the circuit breaker is switched off. Check if there is a power failure. Check your fuse. Make sure it is not blown out.
The temperature does not change.	<ul style="list-style-type: none"> Check if you selected Fan mode. Press the Mode button on the remote control to select another mode.
The cool air does not come out of the air conditioner.	<ul style="list-style-type: none"> Check if the set temperature is higher (lower) than the current temperature. Press the Temperature button on the remote control to change the set temperature. Press the Temperature button to decrease or increase the temperature. Check if the air filter is blocked by dirt. Clean the air filter every two weeks. Check if the air conditioner has just been turned on. If so, wait 3 minutes. Cool air does not come out to protect the compressor of the outdoor unit. Check if the air conditioner is installed in a place with a direct exposure to sunlight. Hang curtains on windows to boost cooling efficiency. Check if the cover or any obstacle is not near the outdoor unit. Check if the refrigerant pipe is too long. Check if the air conditioner is only available in Cool mode. Check if the remote control is only available for cooling model.
The fan speed does not change.	<ul style="list-style-type: none"> Check if you selected Auto or Dry mode. The air conditioner automatically adjusts the fan speed to Auto in Auto/Dry mode.
Timer function does not set.	<ul style="list-style-type: none"> Check if you press the Power button on the remote control after you have set the time.
Odors permeate in the room during operation.	<ul style="list-style-type: none"> Check if the appliance is running in a smoky area or if there is a smell entering from outside. Operate the air conditioner in Fan mode or open the windows to air out the room.
The air conditioner makes a bubbling sound.	<ul style="list-style-type: none"> A bubbling sound may be heard when the refrigerant is circulating through the compressor. Let the air conditioner operate in a selected mode. When you press the Power button on the remote control, noise may be heard from the drain pump inside the air conditioner.
Water is dripping from the air flow blades.	<ul style="list-style-type: none"> Check if the air conditioner has been cooling for an extended period of time with the air flow blades pointed downwards. Condensation may generate due to the difference in temperature.
Remote control is not working.	<ul style="list-style-type: none"> Check if your batteries are depleted. Make sure batteries are correctly installed. Make sure nothing is blocking your remote control sensor. Check that there are strong lighting apparatus near the air conditioner. Strong light which comes from fluorescent bulbs or neon signs may interrupt the electric waves.
The air conditioner does not turn on or off with the wired remote control.	<ul style="list-style-type: none"> Check if you set the wired remote control for group control.
The wired remote control does not operate.	<ul style="list-style-type: none"> Check if TEST indicator is displayed on the wired remote control. If so, turn off the unit and switch off the circuit breaker. Call your nearest contact center.
The indicators of the digital display flashes.	<ul style="list-style-type: none"> Press the Power button on the remote control to turn the unit off and switch the circuit breaker off. Then, switch it on again.

appendix

OPERATION RANGES

The table below indicates the temperature and humidity ranges the air conditioner can be operated within. Refer to the table for efficient use.

MODE	OPERATIONAL TEMPERATURE		INDOOR HUMIDITY	IF OUT OF CONDITIONS
	INDOOR	OUTDOOR		
COOLING	21°C to 32°C	21°C to 54°C	80% or less	Condensation may occur on the indoor unit with risk to have either water blow off or drops on the floor.
DRYING	21°C to 32°C	21°C to 54°C	-	Condensation may occur on the indoor unit with risk to have either water blow off or drops on the floor.

 If the cooling operation is used at over 32°C (indoor temperature), it does not cool at its full capacity.

Memo

ENGLISH



This product is not manufactured for Iran.
SVC Warranty will not be applicable and the user
will be responsible for service expenses when the product is used in Iran.

QUESTIONS OR COMMENTS?

COUNTRY	CALL	OR VISIT US ONLINE AT
IRAN	021-8255	www.samsung.com www.samservice.com
KUWAIT	183-2255	www.samsung.com
BAHRAIN	8000-4726	www.samsung.com
EGYPT	08000-726786	www.samsung.com
JORDAN	800-22273	www.samsung.com
MOROCCO	080 100 2255	www.samsung.com
OMAN	800-SAMSUNG (726-7864)	www.samsung.com
SAUDI ARABIA	9200-21230	www.samsung.com
TURKEY	444 77 11	www.samsung.com
U.A.E	800-SAMSUNG (726-7864)	www.samsung.com
SOUTH AFRICA	0860-SAMSUNG(726-7864)	www.samsung.com

Cassette Type Series
4 Way cassette

Air Conditioner user manual



This manual is made with 100% recycled paper.

imagine the possibilities

Thank you for purchasing this Samsung product.
To receive more complete service, please
register your product at

www.samsung.com/register