

CS21Z43/21Z45/21Z47/21Z50/21Z57
/21Z58/21AE0/21AF0/21AJ0/21AD0/
21BA0/21AS0/21BF0

Owner's Instructions

Before operating, please read this manual thoroughly,
and retain it for future reference.

Register your product at
www.samsung.com/global/register

Control Panel (depending on the model)

➤ The actual configuration of your TV may be different,
depending on your model.

Front (or Side) Panel

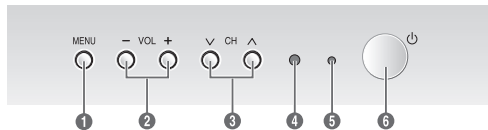

- ❶ On-screen menu display
- ❷ Volume adjustment
- ❸ Channel selection
- ❹ Remote control sensor
- ❺ Standby indicator
- ❻ Power on/off

- ◆ You can use the ❸ buttons to switch the TV on when it is in standby mode depending on the model.
- ◆ The ❷ and ❸ buttons also have the same function as the ◀/▶/▲/▼ buttons on the remote control.
- ◆ If the remote control no longer works or you have misplaced it, you can use the controls on the panel of the television.

Connection Panel (depending on the model)

➤ The actual configuration of your TV may be different,
depending on your model.

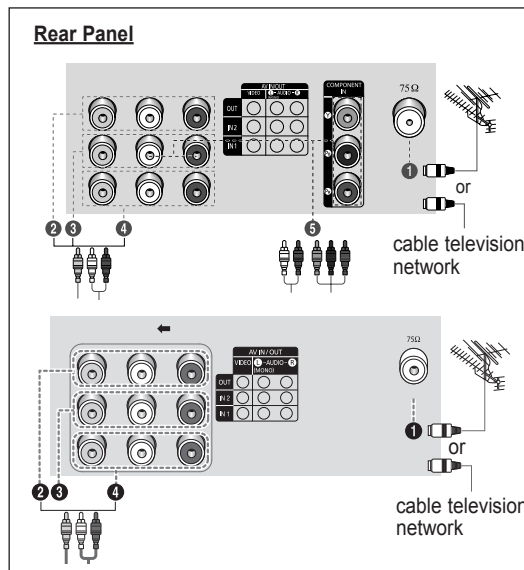

☛ Whenever you connect an audio or video system to your television, ensure that all elements are switched off. Please be sure to match the color coded input terminals and cable jacks.

Connecting to an Aerial or Cable Television Network

Connect the aerial or network input cable to the ❶ (75 Ω coaxial socket).

To view television channels correctly, a signal must be received by the set from one of the sources: an outdoor aerial, cable television network, or satellite network.

If you are using an indoor aerial, you may need to adjust it when tuning your television until you obtain a picture that is both sharp and clear.

Connecting to the RCA Output

The RCA ❷ connectors are used for equipment, such as a recording VCR or audio system.

Connecting to the RCA Input

The RCA ❸ and RCA ❹ connectors are used for equipment, such as a VCR, DVD, decoder, satellite receiver, video game device, or video disc player. (When using the mono equipment, connect to the AUDIO-L input connector.)

The RCA ❺ connectors are used for equipment such as a DVD with component output.

Front (or Side) Panel

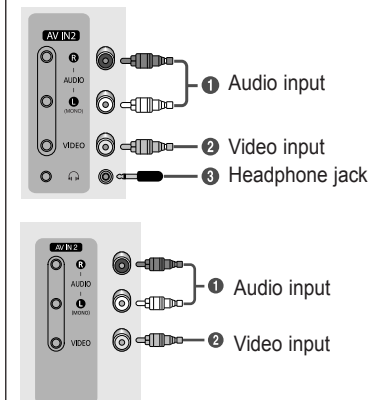

☛ Please be sure to match the colour coded input terminals and cable jacks.

Connecting to the RCA Input

The ❶ (AUDIO-L/R) and ❷ (VIDEO) connectors are used for equipment, such as a camcorder, video disc player, or video game device.

Connecting Headphones

The ❸ (headphone) jack is used for watching a television programme without disturbing the other people in the room. Prolonged use of headphones at a high volume may damage your hearing.

➤ When both the front (or side) AV and rear connectors are connected to external equipment, the front (or side) AV receives priority.

continued...



Remote Control (depending on the model)

- Operation of remote control may be affected by bright artificial light near to the TV.

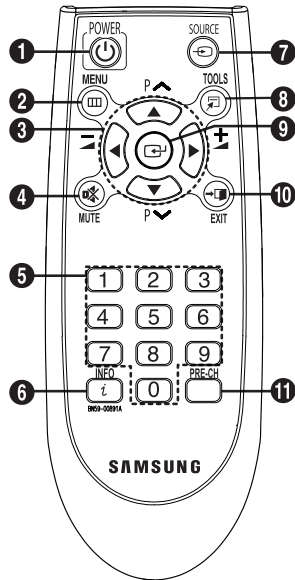

- 1 POWER**
Used to switch the TV on and off.
- 2 MENU**
Used to display the on-screen menu or return to the previous menu.

- 3 ▲/▼/◀/▶**
Used to control the cursor in the menu.
- P ▲ / ▼**
Used to display the next or previous stored channel
- ▲ + / -**
Used to increase or decrease the volume.

- 4 MUTE**
Used to switch the sound off temporarily. To turn the sound back on, press the **MUTE**, **▲ +** or **▲ -** button.
- 5 Numeric buttons**
Used to select channels directly.
- 6 INFO**
Used to view the channel information and setting status you selected.
- 7 SOURCE**
Used to display all of the available video sources.
- 8 TOOLS (depending on the model)**
You can check the following selection by pressing Tools button.
- 1. Sleep Timer**(Used to select a preset time interval for automatic turn off.)
 - 2. Picture Mode**(Used to select the picture effect.)
 - 3. Sound Mode**(Used to select sound effect.)
- 4. Dual I-ii**(Used to select sound mode.)
- 5. Turbo Plus**(Used to select the Turbo Plus option.)
- 6. Equalizer** (Used to display the Equalizer menu)
- 7. Easy View**
Used to display Channel Grouping, Channel Minimizer, Channel Scheduler, Music Mode, Half Mute menu.
- 9 ENTER**
While using the on-screen menus, press the **ENTER** button to activate (or change) a particular item.
- 10 EXIT**
Used to exit from any display or return to normal viewing.
- 11 PRE-CH**
Used to switch repeatedly between the last two channels displayed.

Installing Batteries

Remove the cover. Install two AAA size batteries, then replace the cover. When the remote control does not operate normally, check that the “+” and “-” ends of the batteries are inserted correctly or the batteries are drained.

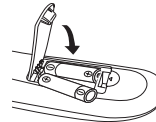

- Do not mix battery types, i.e. alkaline and manganese.

Turning the TV On and Off

Press the “ POWER ” button, or **P ▲ / ▼** button, or **Numeric** button on the remote control. You can also use the “ **⏻** ” button on the TV.

- Caution: One pole switch is totally not off (one line still live) if power cord is not unplugged.

Viewing the Menus

- 1 Press the **MENU** button.
The main menu is displayed on the screen. Its left side has five icons: **Input**, **Picture**, **Sound**, **Channel**, and **Setup**.
- 2 Press the **▲** or **▼** button to select one of the icons. Press the **ENTER** button to access the icon's sub-menu.
- 3 Press the **▲** or **▼** button to move to items in the menu. Press the **ENTER** button to enter items in the menu.
- 4 Press the **▲/▼/◀/▶** button to change the selected items. Press the **MENU** button to return to the previous menu.
- 5 Press the **EXIT** button to exit from the menu.

Setup - Plug & Play

When the television is initially powered on, several basic customer settings proceed automatically and subsequently. The following settings are available.

- 1 If the television is in standby mode, press the **POWER** button on the remote control. The **Start Plug & Play** is displayed. To start Plug & Play, press the **ENTER** button. The **Language** menu is displayed.



- The **Language** menu will automatically appear after several seconds, even if the **ENTER** button is not pressed.

- 2 Select the appropriated language by pressing the **▲** or **▼** button. Press the **ENTER** button. The **Check antenna input.** is displayed.
- If any language is not selected, the language menu will disappear about 30 seconds later.



continued...

- 3 Make sure that the antenna is connected to the television (refer to page 1). Press the **ENTER** button. The **Area** menu is displayed.
- 4 Press the **▲** or **▼** button to select your area. Press the **ENTER** button.
- 5 To search the channels, press the **ENTER** button. To stop the search, press the **ENTER** button.
When the channel searching has finished, the **Clock Set** menu is displayed.
- 6 Press the **◀** or **▶** button to move to the hour or minute. Set the hour or minute by pressing the **▲** or **▼** button.
- 7 When you have finished, press the **MENU** button. The **Enjoy your watching.** is displayed, and then the channel which has been stored will be activated.

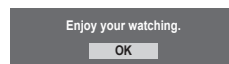
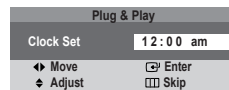
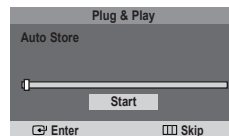
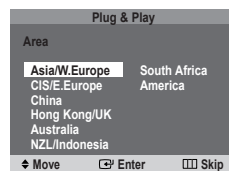
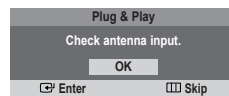

Re-setting the Plug & Play Method:
MENU → **▲/▼ (Setup)** → **ENTER** → **▲/▼ (Plug & Play)** → **ENTER**

Input Source List

- ◆ **Source List**
You can switch between viewing signal from connected equipment, such as a VCR, DVD, set-top box, and the TV source (broadcast or cable).

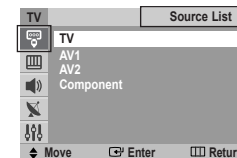

- You can change the required source simply by pressing the **SOURCE** button on the remote control. It might take a short period of time for pictures to be switched.

Channel - Auto Store

You can scan for the frequency ranges available to you (and availability depends on your country). Automatically allocated programme numbers may not correspond to actual or desired programme numbers. However you can sort numbers manually and clear any channels you do not wish to watch.

Channels are sorted and stored in the order which reflects their position in the frequency range (with lowest first and highest last). The programme originally selected is then displayed.

- To stop the search before it has finished, press the **ENTER** button.

When finished, the **Sort** menu is displayed. To sort the stored channels into the desired numerical order, refer to "**Channel - Sort**". To exit without sorting, press the **EXIT** button.

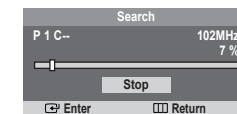

Channel - Sort

This operation allows you to change the programme numbers of stored channels. This operation may be necessary after using auto store.

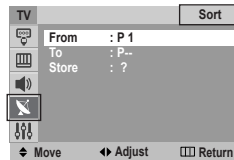

- ◆ **From:** Channel number to be changed.
- ◆ **To:** New channel number to be identified.
- ◆ **Store:** Confirmation the exchange of channel numbers.

Channel - Manual Store

You can store channels, including those received via cable networks. When storing channels manually, you can choose:

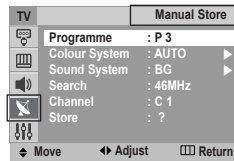

- Whether or not to store each of the channels found
- The programme number of each stored channel which you wish to identify
- ◆ **Programme** (Programme number to be assigned to a channel)
- ◆ **Colour System:** AUTO/PAL/SECAM/NTSC4.43/NTSC3.58
- ◆ **Sound System:** BG/DK/I/M
- ◆ Search (When you do not know the channel numbers): The tuner scans the frequency range until the first channel or the channel that you selected is received on the screen.
- ◆ Channel (When you know the number of the channel to be stored)
 - You can also select the channel number directly by pressing the numeric buttons (0~9).
- ◆ **Store** (When you store the channel and associated programme number)
 - If there is no sound or abnormal sound, re-select the sound standard required.

continued...

Channel mode

- ◆ **P** (Programme mode): When completing tuning, the broadcasting stations in your area have been assigned to position numbers from P00 to P99. You can select a channel by entering the position number in this mode.
- ◆ **C** (Real channel mode): You can select a channel by entering the assigned number for each air broadcasting station in this mode.
- ◆ **S** (Cable channel mode): You can select a channel by entering the assigned number for each cable channel in this mode.

Channel - Add/Delete

You can exclude channels you have chosen from the channels you scanned. When you scan through the stored channels, those you have chosen to skip are not displayed. All of the channels that you did not specifically choose to skip are displayed during scanning.

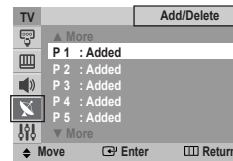

Method:

ENTER : Select **Added** or **Deleted**.

Channel - Fine Tune

If the reception is clear, you do not have to fine-tune the channel, as this is done automatically during the search and store operation. If however the signal is weak or distorted, you may have to fine-tune the channel manually.

Method:

- ◀/▶ : You can obtain a sharp and clear picture and good sound quality.
- ▲/▼ → **ENTER** : You can reset the setting.

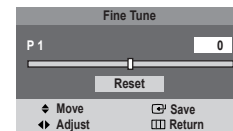

ENTER : You can memorise adjusted picture or sound.

Channel - Channel Grouping

You can choose your category and find your desired channel in a few seconds. You can save a channel under the following categories-Movie, Music, News, Sport, and User.

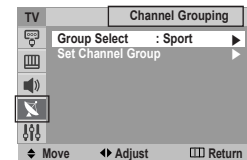

Method:

- ▲/▼ : Used to select a Programme.
- ◀/▶ : Used to select the desired channel group.
- ▲/▼ : Used to confirm the new choice.

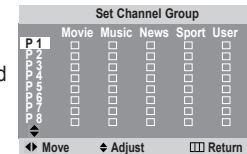

- You can press **TOOLS** button and enter **Easy View** to use this function.

Channel - LNA (depending on the model)

When a weak broadcast signal causes an unclear, noisy picture, the "LNA" feature improves the picture quality by setting to "On". If you experience noise on a certain noise on a certain channel, set the "LNA" to "On" or "Off" for this channel, to obtain the optimum picture.

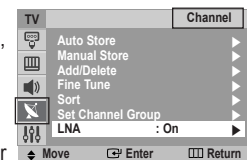

Method:

ENTER : On/Off

Setup - Time

◆ Clock

You can set the television clock so that the current time is displayed when pressing the **INFO** button on the remote control. You must also set the time if you wish to use the automatic on or off timers.

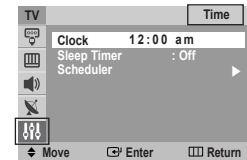

continued...

◆ Sleep Timer

You can select a time period of between 30 and 180 minutes after which the TV automatically switches to standby mode.

- You can also press the **TOOLS** button to enter **Sleep Timer**.

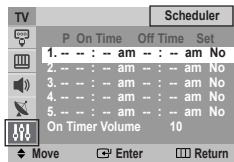

◆ Scheduler

You can set the scheduler to make the TV return to a particular channel at a pre-set time.

- Upto 5 Programmes can be scheduled at a time.
- If the Clock is not set in the Time menu, a pop-up warning will flash if user tries to enter Scheduler.
- You can also use the **TOOLS** button and enter **Easy View** to use this function.

◆ On Timer Volume

The preferred volume can be set for when the timer automatically turns on the TV.

Method:

- ◀/▶ : Move to the hour, minute or am/pm.
- ▲/▼ : Used to set hour, minute or am/pm.
- ▲/▼ → **ENTER** : Set option of YES/NO to activate/deactivate the operation.

- ☞ You must set the clock first.

☞ Auto Power Off

When you set the timer "On", the TV will eventually turn off, if no controls are operated for 3 hours after the TV was turned on by timer. This function is only available in timer "On" mode and prevents overheating, which may occur if a TV is on for too long.

Setup - Child Lock

This feature allows you to prevent unauthorized users, such as children, from watching unsuitable programmes by muting out video and audio. Child Lock cannot be released using front (or side) panel buttons. Only remote control can release the Child Lock setting, so keep the remote control away from children.

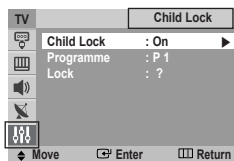

◆ Child Lock: On/Off

If you want to unlock a channel, set to Off.

- ◆ **Programme:** Channel number to be locked.
- ◆ **Lock:** When press the **ENTER** button, the **Locked** is displayed.

- If any channel is locked, you can not access to the Channel and Child Lock menu by using the control buttons on the TV panel (the Not available is displayed in the Child Lock menu). You can access by using the remote control only.

Setup - Language / Blue Screen / Melody / Music Mode

◆ Language

It is variable depending on the model. When you start using the television for the first time, you must select the language which will be used for displaying menus and indications.

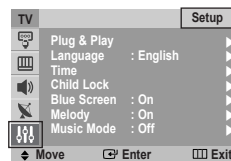

◆ Blue Screen

If no signal is being received or the signal is very weak, a blue screen automatically replaces the noisy picture background. If you wish to continue viewing the poor picture, you must set the **Blue Screen** to **Off**.

◆ Melody

You can hear melody sound when the television is powered on or off.

◆ Music Mode

You can listen to the music/audio with no video or visual distraction.

- When Music Mode is selected, only music is audible and no picture is visible and seen the music mode  on screen.
- You can also press **TOOLS** button and enter **Easy View** to use this function.

Picture - Mode

◆ Mode: Dynamic/ Standard/ Movie/Custom

You can select the type of picture which best corresponds to your viewing requirements.

- You can select these options simply by pressing the **TOOLS** button on the remote control and enter **Picture Mode**.

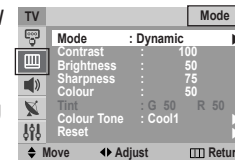

◆ Contrast/Brightness/Sharpness/Colour/Tint(NTSC only)

The television has several settings which allow you to control the picture quality.

◆ Colour Tone: Cool2/Cool1/Normal/Warm1/ Warm2

◆ Reset

You can return to the factory defaults. The reset function is set for each mode (**Dynamic, Standard, Movie, or Custom**).

Picture - Digital NR / DNle Jr

◆ Digital NR

If the signal received by the television is weak, you can activate this feature to reduce any static and ghosting that may appear on the screen.

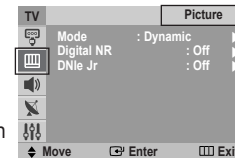

◆ DNle Jr

This feature bring you more detailed image with detail enhancement, contrast enhancement and white enhancement. New image compensation algorithm gives brighter, clearer, much detailed image to you. DNle Jr technology will fit every signals into your eyes.

Sound -

Mode / Equalizer / Auto Volume/ Pseudo Stereo / Turbo Plus / Half Mute

◆ Mode: Standard/Music /Movie/Speech/Custom

You can select the type of special sound effect to be used when watching a given broadcast.

- You can select these options simply by pressing the **TOOLS** button on the remote control and enter **Sound Mode**.

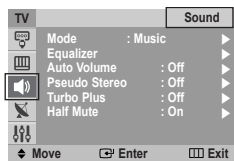

◆ Equalizer

The television has several settings which allow you to control the sound quality.

- If you make any changes to these settings, the sound mode is automatically switched to **Custom**.
- You can also simply press the **TOOLS** button to enter **Equalizer**.

◆ Auto Volume

Each broadcasting station has its own signal conditions, and so it is not easy to adjust the volume every time the channel is changed. This feature lets you automatically adjust the volume of the desired channel by lowering the sound output when the modulation signal is high or by raising the sound output when the modulation signal is low.

◆ Pseudo Stereo

This feature converts a monaural sound signal into two identical left and right channels. Once the Pseudo Stereo is set to On or Off, these settings apply to the sound effects such as **Standard**, **Music**, **Movie**, and **Speech**.

◆ Turbo Plus

This feature suitably emphasizes both higher and lower bands of sound (and includes other effects). You can enjoy more magnificent and dynamic sound when watching music, movie, or other channels.

- You can change the options simply by pressing the **TOOLS** button and enter **Turbo Plus**.

◆ Half Mute

You can reduce volume to half and control volume even in the mute mode.

- When you click the "mute" button once to activate Half Mute see half mute (⌵) on screen, twice for Full Mute see full mute icon (⌵) on screen.
- You can also press **TOOLS** button and enter **Easy View** to use this function.

Selecting the Sound Mode

(depending on the model)

Pressing **TOOLS** button to enter **DUAL I-II** controls the processing and output of the audio signal. When power is switched on, the mode is automatically preset to either "Dual-I" or "Stereo", depending on the current transmission.

Easy View - Channel Minimizer

Easy view is a combination of Video&Audio features that make TV viewing much easier. You can press **TOOLS** button and enter **Easy View**.

Channel minimizer is a feature that offers freedom in the number of channels that you can watch at any time!

To add a Channel.

You can go to your favorite channel you wish to add to Channel Minimizer.

Method:

- ▲ : Add the present channel to Channel Minimizer.
- Repeat the process to add upto six channels.

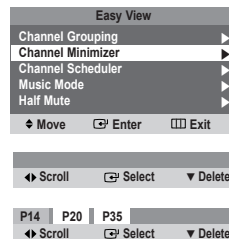

To delete a Channel

You can delete the channel in Channel Minimizer by pressing ▼ button.

◆ NICAM Stereo

Type of broadcast	On-screen indication
Regular broadcast (Standard audio)	Mono (Normal use)
Regular + NICAM Mono	Mono NICAM ↔ Mono (Normal)
NICAM Stereo	Stereo NICAM ↔ Mono (Normal)
NICAM Dual-I/II	Dual-I NICAM ↔ Dual-II NICAM ↔ Mono (Normal)

◆ A2 Stereo

Type of broadcast	On-screen indication
Regular broadcast (Standard audio)	Mono (Normal)
Bilingual or Dual-I/II	Dual-I ↔ Dual-II
Stereo	Stereo ↔ Mono (Forced mono)

- ◆ If the receiving conditions deteriorate, listening will be easier if the mode is set to the **Mono**.
- ◆ If the stereo signal is weak and an automatic switching occurs, then switch to the **Mono**.
- ◆ When receiving a mono sound in the AV mode, connect to the "AUDIO-L" input connector on the panel (front or side). If the mono sound comes out only from left speaker, press the **TOOLS** button and enter **DUAL I-II**.

continued...

continued...

Teletext Feature (depending on the model)

Most television stations provide written information services via teletext. The index page of the teletext service gives you information on how to use the service. In addition, you can select various options to suit your requirements by using the remote control buttons.

For teletext information to be displayed correctly, channel reception must be stable. Otherwise, information may be missing or some pages may not be displayed.

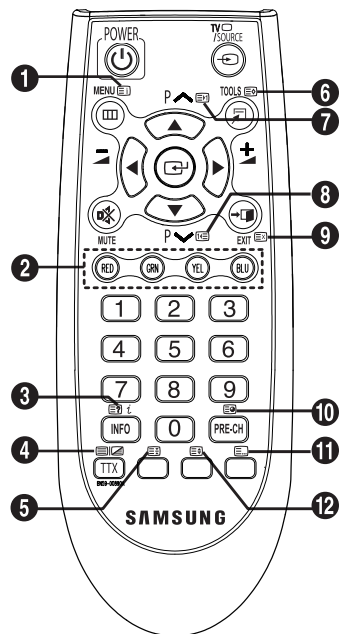

1 (index)

Used to display the index (contents) page at any time while you are viewing teletext.

2 (red/green/yellow/blue)

If the FASTEXT system is used by a broadcasting company, the different topics covered on a teletext page are colour-coded and can be selected by pressing the coloured buttons. Press one of them corresponding to the required. The page is displayed with other coloured information that can be selected in the same way. To display the previous or next page, press the corresponding coloured button.

3 (reveal)

Used to display the hidden text (answers to quiz games, for example). To display normal screen, press it again.

4 (teletext on/mix)

Press to activate teletext mode after selecting the channel providing the teletext service. Press it again to overlap the teletext with the current broadcasting screen.

5 (hold)

Used to hold the display on a given page if the selected page is linked with several secondary pages which follow on automatically. To resume, press it again.

6 (store)

Used to store the teletext pages.

7 (page up)

Used to display the next teletext page.

8 (page down)

Used to display the previous teletext page.

9 (cancel)

Used to display the broadcast when searching for a page.

10 (sub-page)

Used to display the available sub-page.

11 (mode)

Press to select the teletext mode (LIST/FLOF). If you press it in the LIST mode, it switches into the List save mode. In the List save mode, you can save teletext page into list using the (store) button.

12 (size)

Press to display the double-size letters in the upper half of the screen. For lower half of the screen, press it again. To display normal screen, press it once again.

Troubleshooting

Before contacting the Samsung after-sales service, perform using the instructions below, note the model and serial number of the television and contact your local dealer.

No sound or picture

- ◆ Check that the mains lead has been connected to a wall socket.
- ◆ Check that you have pressed the "⏻" button (On/Off) and the **POWER** button.
- ◆ Check the picture contrast and brightness settings.
- ◆ Check the volume.

Normal picture but no sound

- ◆ Check the volume.
- ◆ Check whether the volume **MUTE** button on the remote control has been pressed.

No picture or black and white picture

- ◆ Adjust the colour settings.
- ◆ Check that the broadcast system selected is correct.

Sound and picture interference

- ◆ Try to identify the electrical appliance that is affecting the television, then move it further away.
- ◆ Plug the television into a different mains socket.

Blurred or snowy picture, distorted sound

- ◆ Check the direction, location and connections of your aerial. This interference often occurs due to the use of an indoor aerial.

Remote control malfunctions





- ◆ Replace the remote control batteries.
- ◆ Clean the upper edge of the remote control (transmission window).
- ◆ Check that the "+" and "-" ends of the batteries are inserted correctly.
- ◆ Check that the batteries are drained.

A still image may cause color distortion, but with normal sound(white or highlight image).

- ◆ Switch to other channels with moving image, and check if the color turns normal after 5 minutes.
- ◆ Turn off the TV, and turn it on after 30 minutes to check the color.

OSD Map

* : It is variable depending on the model.

	Input	- Source List	- TV / AV1 / AV2 / Component
	Picture	- Mode	- Dynamic / Standard / Movie / Custom Contrast Brightness Sharpness Colour Tint (NTSC only) Colour Tone - Cool2 / Cool1 / Normal / Warm1 / Warm2 Reset
		- Digital NR	- Off / On
		- DNle Jr	- Off / On
	Sound	- Mode	- Standard / Music / Movie / Speech / Custom
		- Equalizer	
		- Auto Volume	- Off / On
		- Pseudo Stereo	- Off / On
		- Turbo Plus	- Off / On
		- Half Mute	- Off / On
	Channel	- Auto Store	- Area * - Asia/W.Europe / CIS/E.Europe / China / Hong Kong/UK / Australia / NZL/Indonesia / South Africa / America
		- Manual Store	- Search - Programme - Colour System * - AUTO / PAL / SECAM / NTSC4.43 / NTSC3.58 - Sound System * - BG / DK / I / M - Search - Channel - Store
		- Add/Delete	
		- Fine Tune	
		- Sort	
		- Channel Grouping	- Group Select - Set Channel Group
		- LNA *	- Off / On
	Setup	- Plug & Play	
		- Language *	
		- Time	- Clock - Sleep Timer - Scheduler
		- Child Lock	- Child Lock - Programme - Lock
		- Blue Screen	- Off / On
		- Melody	- Off / On
		- Music Mode	- Off / On

Important Warranty Information Regarding Television Format Viewing

Standard screen format televisions (4:3, the aspect ratio of the screen width to height) are primarily designed to view standard format full-motion video. The images displayed on them should primarily be in the standard 4:3 ratio format and constantly moving. Displaying stationary graphics and images on screen, such as the dark top and bottom letterbox bars (wide screen pictures), should be limited to no more than 15% of the total television viewing per week.

Wide screen format televisions (16:9, the aspect ratio of the screen width to height) are primarily designed to view wide screen format full-motion video. The images displayed on them should primarily be in the wide screen 16:9 ratio format, or expanded to fill the screen if your model offers this feature, and constantly moving. Displaying stationary graphics and images on screen, such as the dark side-bars on non-expanded standard format television video and programming, should be limited to no more than 15% of the total television viewing per week.

Additionally, viewing other stationary images and text such as stock market reports, video game displays, station logos, web sites or computer graphics and patterns, should be limited as described above for all televisions. Displaying any stationary images that exceed the above guidelines can cause uneven aging of picture tubes (CRTs) that leave subtle, but permanent burned-in ghost images in the television picture. To avoid this, vary the programming and images, and primarily display full screen moving images, not stationary patterns or dark bars. On television models that offer picture sizing features, use these controls to view the different formats as a full screen picture.

Be careful in the selection and duration of television formats used for viewing. Uneven CRT aging as a result of format selection and use, as well as other burned-in images, is not covered by your Samsung limited warranty.