

WF7754N4(W/V/S/C/R) WF7658N4(W/V/S/C/R)  
WF7752N4(W/V/S/C/R) WF7522N4(W/V/S/C/R)  
WF7750N4(W/V/S/C/R) WF7520N4(W/V/S/C/R)  
WF7758N4(W/V/S/C/R) WF7528N4(W/V/S/C/R)  
WF7654N4(W/V/S/C/R) WF7452N4(W/V/S/C/R)  
WF7652N4(W/V/S/C/R) WF7450N4(W/V/S/C/R)  
WF7650N4(W/V/S/C/R) WF7458N4(W/V/S/C/R)

# Washing Machine user manual

imagine the possibilities

Thank you for purchasing a Samsung product.  
To receive a more complete service,  
please register your product at  
[www.samsung.com/global/register](http://www.samsung.com/global/register)



# features

---

- **Child Lock**

The Child Lock function keeps curious little hands out of the washer. This safety feature ensures, that children do not toy with the operation of the washer. It also alerts you when it is activated.

- **Handwash**

Clothes susceptible to damage, such as those made of linen or silk, can be washed just as if they were being washed by hand.

- **Delay Start**

This function enables users to delay the washing machine's starting time for up to 24 hours.

- **Heavy Soil**

This Program is for stained or heavily soiled cottons, bed linen, table linen, underwear, towels, shirts, jeans, etc

# safety information

---

Throughout this manual, you'll see Warning and Caution notes.



These warnings, cautions, and the important safety instructions that follow do not cover all possible conditions and situations that may occur.

It's your responsibility to use common sense, caution, and care when installing, maintaining, and operation your washer. Samsung is not liable for damages resulting from improper use.

## IMPORTANT SAFETY SYMBOLS AND PRECAUTIONS

---

What the icons and signs in this user manual means:

 <b>WARNING</b>	Hazards or unsafe practices that may result in <b>severe personal injury or death</b> .
 <b>CAUTION</b>	Hazards or unsafe practices that may result in <b>minor personal injury or property damage</b> .
 <b>CAUTION</b>	To reduce the risk of fire, explosion, electric shock, or personal injury when using your washer, follow these basic safety precautions:

## BEFORE USING THE APPLIANCE

---

 Packing materials can be dangerous to children; keep all packing material (plastic bags, polystyrene, etc.) well out of the reach of children.

The appliance is designed for home use only.



Make sure that water and electrical connections are made by qualified technicians, observing the manufacturer's instructions (see "Installing the Washing Machine") and local safety regulations.

All packaging and shipping bolts must be removed before the appliance is used. Serious damage may occur if they are not removed. See "Removing the shipping bolts".

Before washing clothes for the first time, you must run a complete cycle without clothes. See "Washing for the first time".

## SAFETY INSTRUCTIONS

---

 Before cleaning or carrying out maintenance, unplug the appliance from the electrical outlet or set the  (On/Off) button to Off.

Make sure that the pockets of all clothing to be washed are empty.

Hard, sharp objects, such as coins, safety pins, nails, screws, or stones can cause extensive damage to the appliance.

Always unplug the appliance and turn off the water after use.

Before you open the door of the appliance, check that the water has drained. Do not open the door if you can still see water.

# safety information

---

Pets and small children may climb into the appliance. Check the appliance before each use.

The glass door becomes very hot during the washing cycle. Keep children away from the appliance while it is in use.

Do not attempt to repair the appliance yourself. Repairs made by inexperienced or unqualified persons may cause injury and/or make more serious repairs to the appliance necessary.

If the plug (power supply cord) is damaged, it must be replaced by the manufacturer or its service agent or a similar qualified person in order to avoid a hazard.

This appliance should only be serviced by an authorized service center, and only genuine spare parts should be used.

This appliance is not intended for use by young children or infirm persons unless they have been adequately supervised by a responsible person to ensure that they can use the appliance safely. Young children should be supervised to ensure that they do not play with the appliance.

This appliance has to be connected to the plug endurable to proper power consumption.

This appliance has to be positioned so that the plug is accessible after installation.

Do not use processed water containing oil, cream or lotion, which is usually found in skin-care shops or massage clinics.

- Otherwise this will cause the packing to be deformed, which causes a malfunction or water leak.

A stainless washing tube does not usually rust. However if some metal such as a hair pin is left in the tube for an extended time, the tube could rust.

- Do not leave water or bleach containing chlorine in the tube for an extended period of time.
- Do not regularly use or leave water containing iron in the tube for an extended period of time.
- If rust starts appearing on the surface of the tube, apply a cleansing agent (neutral) to the surface and use a sponge or soft cloth to clean it. (Under no circumstances use a metal brush)

For washing machines with ventilation openings in the base, that a carpet must not obstruct the openings.

Use the new hose-sets and old hose-sets should not be reused.

# contents

---

## **INSTALLING THE WASHING MACHINE**

6

- 6 Unpacking the Washing Machine
- 6 Overview of the washing machine
- 7 Selecting a location
- 7 Adjusting the leveling feet
- 7 Removing the shipping bolts
- 8 Connecting the water supply hose
- 8 Positioning the drain hose
- 9 Connecting the water supply hose (Option)
- 10 Plugging in the machine

## **WASHING A LOAD OF LAUNDRY**

11

- 11 Washing for the first time
- 11 Putting detergent in the washing machine
- 12 Overview of the control panel
- 14 Washing clothes using Fuzzy Logic
- 14 Using delay start
- 15 Washing clothes manually
- 15 Washing tips and hints

## **MAINTAINING THE WASHING MACHINE**

16

- 16 Draining the washing machine in an emergency
- 16 Repairing a frozen washing machine
- 16 Cleaning the exterior
- 17 Cleaning the detergent drawer and recess
- 17 Cleaning the debris filter
- 18 Cleaning the water hose mesh filter

## **TROUBLESHOOTING**

19

- 19 Problems and solutions
- 19 Understanding error messages

## **PROGRAMME CHART**

20

- 20 Programme chart

## **APPENDIX**

21

- 21 Fabric care chart
- 21 Electrical warnings
- 21 Protecting the environment
- 22 Declaration of conformity
- 22 Specification

# installing the washing machine

## UNPACKING THE WASHING MACHINE

Unpack your washing machine and inspect it for shipping damage. Also make sure that you have received all of the items shown below. If the washing machine was damaged during shipping or you do not have all of the items, contact your Samsung dealer immediately.

## OVERVIEW OF THE WASHING MACHINE

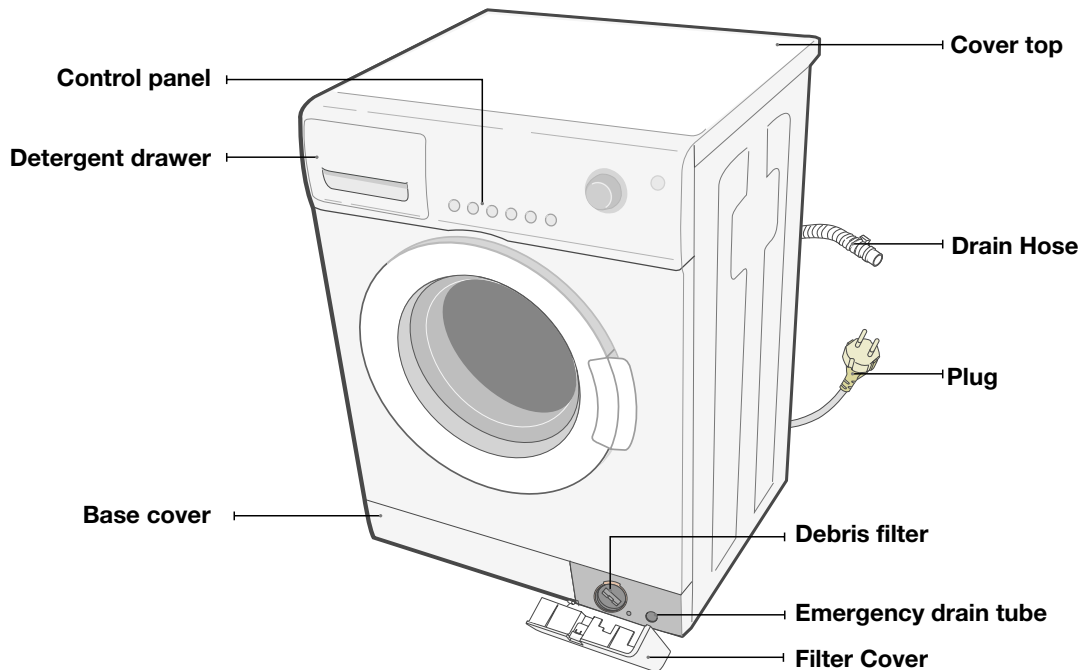

Wrench

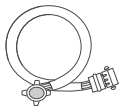

Water supply hose



Hose guide

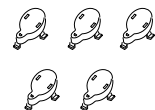

Bolt hole covers

## SELECTING A LOCATION

Before you install the washing machine, select a location with the following characteristics:

- A hard, level surface (if the surface is uneven, see “Adjusting the leveling feet,” below)
- Away from direct sunlight.
- Adequate ventilation
- Room temperature that will not fall below 0 °C
- Away from sources of heat such as coal or gas

Make sure that the washing machine does not stand on its power cord.

Ventilation openings must not be obstructed by carpeting when the washing machine is installed on a carpeted floor.

## ADJUSTING THE LEVELING FEET

If the floor is uneven, adjust the feet (do not insert pieces of wood or any other objects under the feet):

1. Loosen the leg bolt by turning it with your hand until it is at the desired height.
2. Tighten the locking nut by turning it with the wrench.
  - Place the washer on a sturdy, flat surface.

If the washer is placed on an uneven or weak surface, noise or vibration occurs. (Only a 1 degrees angle is allowed.)

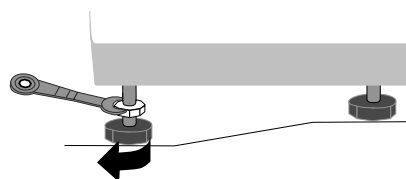

## REMOVING THE SHIPPING BOLTS

Before using the washing machine, you must remove all of the shipping bolts from the back of the unit. To remove the bolts:

1. Loosen all bolts with the wrench before removing them.
2. Take each bolt head and pull it through the wide part of the hole. Repeat for each bolt.
3. Fill the holes with the supplied plastic covers.
4. Keep the shipping bolts for future use.

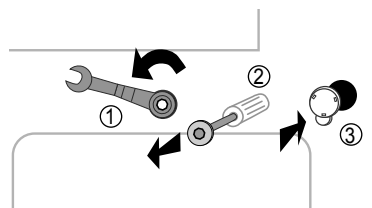

# installing the washing machine

## CONNECTING THE WATER SUPPLY HOSE

The water supply hose must be connected to the washing machine at one end and to the water faucet at the other. Do not stretch the water supply hose. If the hose is too short and you do not wish to move the water faucet, replace the hose with a longer, high pressure hose.

### To connect the water supply hose:

1. Take the L-shaped arm fitting for the cold water supply hose and connect to the cold water supply intake on the back of the machine. Tighten by hand.

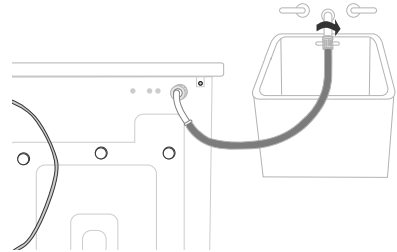

2. Connect the other end of the cold water supply hose to your sink's cold water faucet and tighten it by hand. If necessary, you can reposition the water supply hose at the washing machine end by loosening the fitting, rotating the hose, and retightening the fitting.

### Option:

1. Take the red L-shaped arm fitting for the hot water supply hose and connect to the red hot water supply intake on the back of the machine. Tighten by hand.
2. Connect the other end of the hot water supply hose to your sink's hot water faucet and tighten it by hand.
3. Use a Y-piece if you only want to use cold water.

## POSITIONING THE DRAIN HOSE

The end of the drain hose may be positioned in three ways:

### Over the edge of a sink

The drain hose must be placed at a height of between 60 and 90 cm. To keep the drain hose spout bent, use the supplied plastic hose guide. Secure the guide to the wall with a hook or to the faucet with a piece of string to prevent the drain hose from moving.

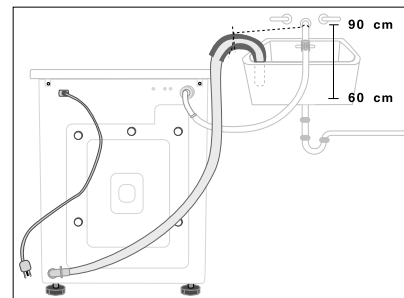

### In a sink drain pipe branch

The drain pipe branch must be above the sink siphon so that the end of the hose is at least 60 cm above the ground.

### In a drain pipe

Samsung recommends that you use a 65 cm high vertical pipe; it must be no shorter than 60 cm and no longer than 90 cm.



## CONNECTING THE WATER SUPPLY HOSE (OPTION)

1. Remove the adaptor from the water supply hose.



2. First, using a '+' type screw driver, loosen the four screws on the adaptor. Next, take the adaptor and turn part(b) following the arrow until there is a 5mm gap.



3. Connect adaptor to the water tap by tightening the screws firmly. Then, turn part (b) following the arrow and put(a) and (b) together.

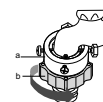

4. Connect the water supply hose to the adaptor. Pull down part (c) of the water supply hose. When you release part (c) the hose automatically connects to the adaptor making a 'click' sound.

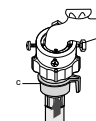

5. Connect the other end of the water supply hose to the inlet water valve at the rear of the washer. Screw the hose clockwise all the way in.



- If the water tap has a screw type faucet, connect the water supply hose to the tap as shown.

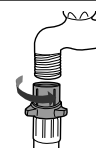

-  After completing connection, if water leaks from the hose, then repeat the same steps. Use the most conventional type of faucet for water supply. In case the faucet is square or too big, remove the spacing ring before inserting the faucet into the adaptor.

# installing the washing machine

---

## PLUGGING IN THE MACHINE

---

### Wiring Instructions

---

**- WARNING THIS APPLIANCE MUST BE EARTHED.**

This appliance must be earthed. In the event of an electrical short circuit, earthing reduces the risk of electric shock providing an escape wire for the electric current.

The appliance is equipped with a mains lead which includes an earth wire for connecting to the earth terminal of your mains plug.

The plug must be plugged into a socket that is properly installed and earthed.

- \* Consult a qualified electrician or service technician if in doubt about any of these instructions. The manufacturer of this washing machine will not accept any liability for damage to persons or material for non observance of these requirements.

There are no user serviceable parts inside the washing machine and if the mains lead of this appliance is damaged, it must only be replaced by qualified service personnel approved by the manufacturer because special tools are required.

# washing a load of laundry

## WASHING FOR THE FIRST TIME

Before washing clothes for the first time, you must run a complete cycle without clothes.

### To do this:

1. Press the ⏻ (On/Off) button.
2. Pour a little detergent into compartment (II) in the detergent drawer.
3. Turn on the water supply to the washing machine.
4. Press the Temperature button repeatedly until 40 °C is displayed.
5. Press the Start/Pause button.
  - This will remove any water from the manufacturer's test run remaining in the machine.

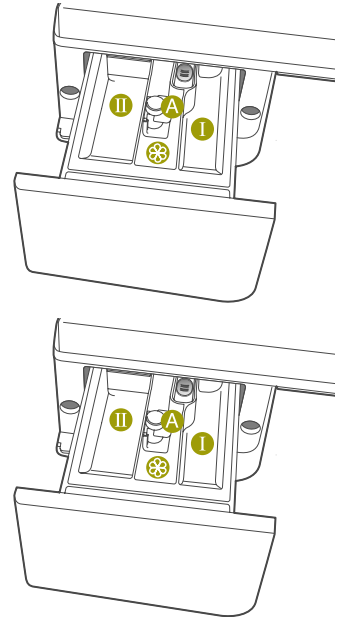

**Dispenser ①:** Detergent for prewash or starch.

**Dispenser ②:** Detergent for main wash, water softener, pre-soaking agent, bleach and stain removal product.

**Dispenser ③:** Additives, e.g. fabric softener or former (fill no higher than lower edge of insert "A")

## PUTTING DETERGENT IN THE WASHING MACHINE

1. Pull out the detergent drawer.
2. Add laundry detergent into compartment (II).
3. Add softener into compartment (③) (if you desire).
4. Add prewash detergent into compartment (I) (if you desire).



Concentrated or thick fabric softener and conditioner must be diluted with a little water before being poured into the dispenser (prevents the overflow from becoming blocked).

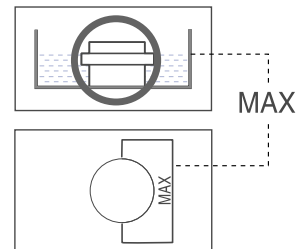





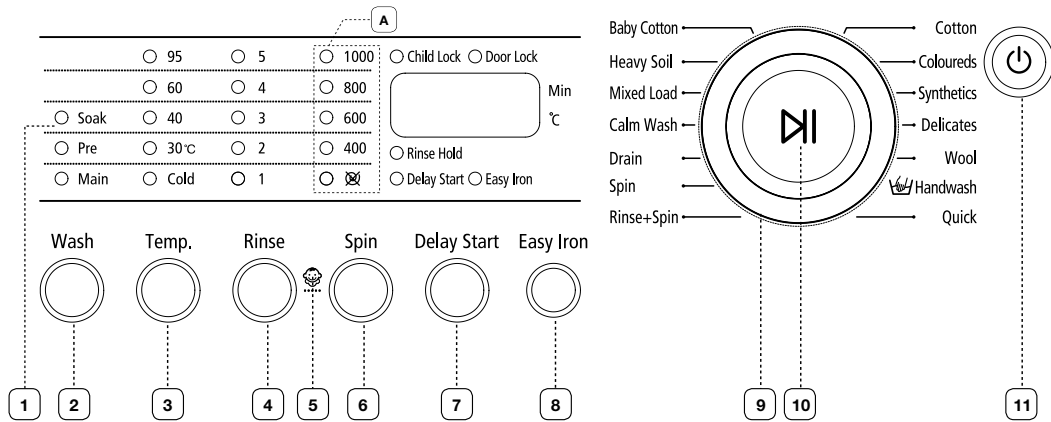



# washing a load of laundry

## OVERVIEW OF THE CONTROL PANEL



※ This is a general manual. The INLAY system may be different from that of the product you purchased. For (A), see item 6 below to select the right specifications that match your product.

<p><b>1</b> Digital graphic display</p>	<p>Displays the remaining wash cycle time, all of washing information and error messages.</p>
<p><b>2</b> Wash selection button</p>	<p>Press the button to select wash. Wash is available only with Daily Wash, Baby Cotton, Heavy Soil, Bed Linen, Cotton, Coloureds, Synthetics, Delicates.</p>
<p><b>3</b> Temperature selection button</p>	<p>Press the button repeatedly to cycle through the available water temperature options (cold water(氷), 30 °C, 40 °C, 60 °C and 95 °C).</p>
<p><b>4</b> Rinse selection button</p>	<p>Press the <b>Rinse</b> button to add rinse cycles. Maximum number of rinse cycles is five.</p>
<p><b>5</b> Child Lock selection button</p>	<p>This is a button for preventing children from manipulating the washing machine.</p> <p><b>On/Off</b> - To set the program on: Press the <b>Start/Pause</b> button to turn on the washing machine.</p> <p>Press and hold down the “<b>Rinse</b>” + “<b>Spin</b>” button for 2-3 seconds. It can only be activated when the machine is turned on. Once you set the Child Lock on while in washing, no button is activated until you set it off. Only the <b>POWER</b> button can activate. The Child Lock lamp lights on. To set the program off: Press and hold down the “<b>Rinse</b>” + “<b>Spin</b>” button again for 2-3 seconds, then the lamp lights off and is set off.</p> <p> Check out the <b>Child Lock</b> button first when no button is activated while the washing machine is working.</p>



<p><b>6 Spin selection button</b></p>	Press the button repeatedly to cycle through the available spin speed options.	
	WF7754N4/WF7654N4	Rinse Hold,  , 400, 800, 1200, 1400 rpm
	WF7752N4/WF7652N4/ WF7522N4/WF7452N4	Rinse Hold,  , 400, 800, 1000, 1200 rpm
	WF7750N4/WF7650N4/ WF7520N4/WF7450N4	Rinse Hold,  , 400, 600, 800, 1000 rpm
	WF7758N4/WF7658N4/ WF7528N4/WF7458N4	Rinse Hold,  , 400, 600, 800, 800+ rpm
<p><b>No spin</b>  : The laundry remains in the drum without being spun after the final drain</p> <p><b>Rinse Hold:</b> The laundry remains soaking in the final rinse water. Before the laundry can be unloaded, either “<b>Drain</b>” or the “<b>Spin</b>” program must be run.</p>		
<p><b>7 Delay Start selection button</b></p>	Press the button repeatedly to cycle through the available delayed start options (from 4 hour to 24 hours in one hour increments). Displayed hours means the time of finished washing-cycle.	
<p><b>8 Easy Iron selection button</b></p>	Easy Iron programme eased ironing the laundry. (Cotton, Coloureds, Quick, Baby Cotton, Heavy Soil, Mixed Load)	
<p><b>9 Fuzzy Control dial</b></p>	Turn the dial to select one of the 14 available wash programs: Cotton, Coloureds, Synthetics, Delicates, Wool, Hand Wash, Quick, Rinse+Spin, Spin, Drain, Daily Wash, Baby Cotton, Heavy Soil, Bed Linen	
<p><b>10  Start/Pause selection button</b></p>	Press to pause and restart programs.	
<p><b>11  (On/Off) selection button</b></p>	Press once to turn the washing machine on, press again to turn the washing machine off. If the washing machine power is left on for longer than 10 minutes without any buttons being touched, the power automatically turns off.	

# washing a load of laundry

## WASHING CLOTHES USING FUZZY LOGIC

Your new washing machine makes washing clothes easy, using Samsung's "Fuzzy Logic" automatic control system. When you select a wash programme, the machine will set the correct temperature, washing time, and washing speed.

### To wash clothes using the Fuzzy Logic programs:

1. Turn on your sink's water faucet.
  2. Press the  (On/Off) button.
  3. Press the **Door Open** button and open the door.
  4. Load the articles one at a time loosely into the drum, without overfilling.
  5. Close the door.
  6. Add the detergent, softener, and prewash detergent (if necessary) into the appropriate compartment.
-  Wash is only available when washing Duvet, Bedding, Towel, Curtain, Cotton, Coloureds, Synthetics and Delicates programs. It is only necessary if your clothing is heavily soiled.
7. Turn the Fuzzy Control dial to select the appropriate program for the type of clothes Cotton, Coloureds, Synthetics, Delicates, Wool, Hand wash, Quick, Rinse+Spin, Spin, Drain, Baby Cotton, Heavy Soil, Mixed Load, Heavy Soil, Mixed Load, Calm Wash. You will see the indicators light up on the control panel.

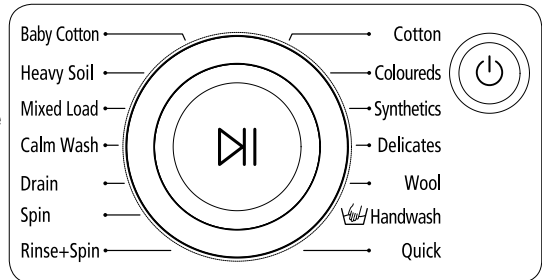

8. At this time, you can control the wash temperature, rinsing times, spin speed, delay time by pressing the appropriate option button.
9. Press the **Start/Pause** button on the Fuzzy Control dial and the wash cycle will begin. The process indicator will light up and the remaining time for the cycle will appear in the display.

### When the cycle is finished:

After the total cycle has finished, the power will turn off automatically.

1. Press the **Door Open** button and open the door.
-  You cannot open the door if the power turns off.
2. Remove laundry.

## USING DELAY START

You can set the washing machine to finish your wash automatically at a later time, choosing from 4 to 24 hour delay (in 1 hour increments). Displayed hours means the time of finished washing-cycle.



### To do this:

1. Manually or automatically set your washing machine for the type of clothes you are washing.
2. Press the **Delay Start** button repeatedly until the delay time is set.
3. Press the **Start/Pause** button. The Delay Start indicator will light, and the clock will begin counting down until it reaches your finish time.
4. To cancel "**Delay Start**", press the , then turn the washing machine on again.

## WASHING CLOTHES MANUALLY

You can wash clothes manually without using the Fuzzy Logic feature.

### To do so:

1. Turn the water supply on.
2. Press the  (On/Off) button on the washing machine.
3. Press the **Door Open** button and open the door.
4. Load the articles one at a time loosely into the drum, without overfilling.
5. Close the door.
6. Put the detergent and, if necessary, softener or prewash detergent, in the appropriate compartments.
7. Press the **Temperature** button to select the temperature. (cold water, 30°C, 40°C, 60°C, 95°C)
8. Press to **Rinse** button to select the required number of rinse cycles.  
Maximum number of rinse cycles is five. The washing duration will be prolonged accordingly.
9. Press the **Spin** button to select the spin speed. ( : No Spin)

The rinse hold program allows you to take clothes that are dripping wet out of the washing machine.



Press the button repeatedly to cycle through the available delayed start options (from 4 hour to 24 hours in one hour increments). Displayed hours means the time of finished washing-cycle.

11. Press the **Start/Pause** button and the machine will begin the cycle.

## WASHING TIPS AND HINTS

**Sorting your laundry:** Sort your laundry according to the following characteristics:

- **Type of fabric care label symbol:** Sort laundry into cottons, mixed fibres, synthetics, silks, wools and rayon.
- **Colour:** Divide whites and colours. Wash new, coloured items separately.
- **Size:** Placing items of different sizes in the same load will improve the washing action.
- **Sensitivity:** Wash delicate items separately, using the Delicate wash programme for pure new wool, curtains and silk articles. Check the labels on the items you are washing or refer to the fabric care chart in the appendix.

**Emptying pockets:** Coins, safety pins and similar items can damage linen, the washing machine drum, and the water tank.

**Securing fasteners:** Close zippers and fasten buttons or hooks; loose belts or ribbons should be tied together.

**Prewashing cotton:** Your new washing machine, combined with modern detergents, will give perfect washing results, thus saving energy, time, water and detergent. However, if your cotton is particularly dirty, use a prewash with a protein-based detergent.

Fabric Type	Load Capacity			
	WF7754N4/ WF7752N4/ WF7750N4/ WF7758N4	WF7654N4/ WF7652N4/ WF7650N4/ WF7658N4	WF7522N4/ WF7520N4/ WF7528N4	WF7452N4/ WF7450N4/ WF7458N4
<b>Coloured/cotton</b>				
-average/lightly soiled	7.5 kg	6.5 kg	5.2 kg	4.5 kg
-heavily soiled	7.5 kg	6.5 kg	5.2 kg	4.5 kg
<b>Synthetics</b>	3.0 kg	3.0 kg	2.5 kg	2.5 kg
<b>Delicates</b>	2.5 kg	2.5 kg	2.0 kg	2.0 kg
<b>Wools</b>	2.0 kg	2.0 kg	1.5 kg	1.5 kg

**Detergent tips:** The type of detergent you should use is based on the type of fabric (cotton, synthetic, delicate items, wool), colour, wash temperature, degree and type of soiling. Always use “low suds” laundry soap, which is designed for automatic washing machines.

Follow the detergent manufacturer’s recommendations based upon the weight of the laundry, the degree of soiling, and the hardness of the water in your area. If you do not know how hard your water is, ask your water authority.



Keep detergents and additives in a safe, dry place out of the reach of children.

# maintaining the washing machine

## DRAINING THE WASHING MACHINE IN AN EMERGENCY

WF7754N4/7752N4/7750N4/7758N4/7654N4/7652N4/7650N4/7658N4

1. Unplug the washing machine from the power supply.
2. Open the filter-cover by using a coin or a key.

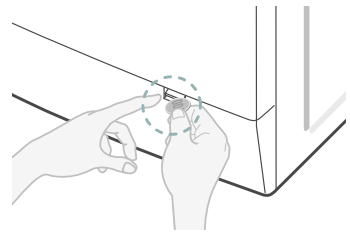

3. Unscrew the emergency drain cap by turning left. Grip the cap on the end of the emergency drain tube and slowly pull it out about 15 cm.
4. Allow all the water to flow into a bowl.
5. Reinsert the drain tube and screw the cap back on.
6. Replace the filter-cover.

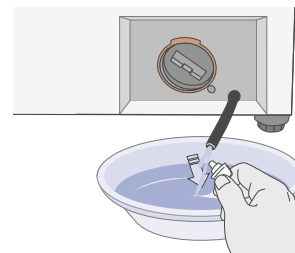

## REPAIRING A FROZEN WASHING MACHINE

If the temperature drops below freezing and your washing machine is frozen:

1. Unplug the washing machine.
2. Pour warm water on the source faucet to loosen the water supply hose.
3. Remove the water supply hose and soak it in warm water.
4. Pour warm water into the washing machine drum and let it sit for 10 minutes.
5. Reconnect the water supply hose to the water faucet and check if the water supply and drain operations are normal.

## CLEANING THE EXTERIOR

1. Wipe the washing machine surfaces, including the control panel, with a soft cloth and nonabrasive household detergents.
2. Use a soft cloth to dry the surfaces.
3. Do not pour water on the washing machine.



## CLEANING THE DETERGENT DRAWER AND RECESS

1. Press the release lever on the inside of the detergent drawer and pull it out.
2. Remove the cap from compartment (⊗).
3. Wash all of the parts under running water.
4. Clean the drawer recess with an old toothbrush.
5. Reinsert the cap (Pushing it firmly into place) and replace the liquid detergent divider into the drawer.
6. Push the drawer back into place.
7. Run a rinse programme without any laundry in the drum.

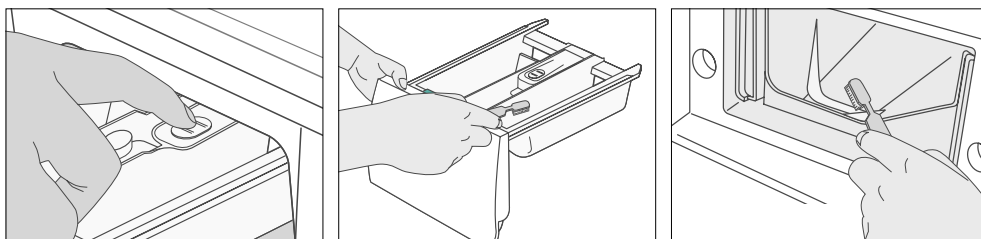

## CLEANING THE DEBRIS FILTER

Clean the debris filter 5 or 6 times a year, or when you see the following error message on the display:

5E

1. Open the filter-cover, See “Draining the washing machine in an emergency” on page 16.
2. Unscrew emergency drain cap by turning left and drain off all the water.  
See “Draining the washing machine in an emergency” on page 16.
3. Unscrew the filter cap and take it out.
4. Wash any dirt or other material from the filter. Make sure the drain pump propeller behind the filter is not blocked.  
Replace the filter cap.
5. Replace the filter-cover.

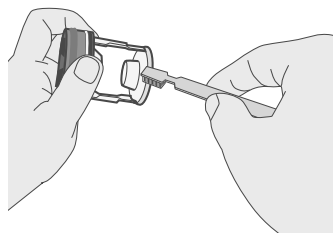

# maintaining the washing machine

## CLEANING THE WATER HOSE MESH FILTER

You should clean the water hose mesh filter at least one time per year, or when you see the following error message on the display:

4E

**To do this:**

1. Turn off the water source to the washing machine.
2. Unscrew the hose from the back of the washing machine.
3. With a pair of pliers, gently pull out the mesh filter from the end of the hose and rinse it under water until clean. Also clean the inside and outside of the threaded connector.
4. Push the filter back into place.
5. Screw the hose back onto the washing machine.
6. Turn on the faucet and make sure the connections are watertight.

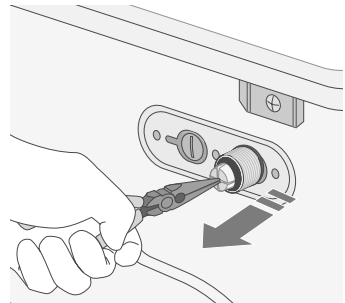
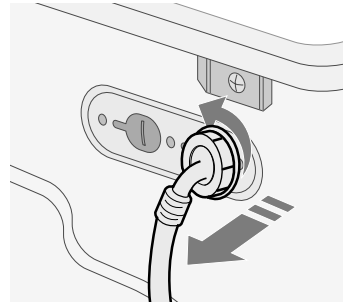

# troubleshooting

## PROBLEMS AND SOLUTIONS

PROBLEM	SOLUTION
The washing machine will not start	<ul style="list-style-type: none"><li>• Make sure the door is firmly closed.</li><li>• Make sure the washing machine is plugged in.</li><li>• Make sure the water source faucet is turned on.</li><li>• Make sure to press the Start/Pause button.</li></ul>
No water or insufficient water supply	<ul style="list-style-type: none"><li>• Make sure the water source faucet is turned on.</li><li>• Make sure the water source hose is not frozen.</li><li>• Make sure the water intake hose is not bent.</li><li>• Make sure the filter on the water intake hose is not clogged.</li></ul>
Detergent remains in the detergent drawer after the wash program is complete	<ul style="list-style-type: none"><li>• Make sure the washing machine is running with sufficient water pressure.</li><li>• Put the detergents in the inner parts of the detergent drawer(away from the outside edges).</li></ul>
Washing machine vibrates or is too noisy	<ul style="list-style-type: none"><li>• Make sure the washing machine is set on a level surface. If the surface is not level, adjust the washing machine feet to level the appliance.</li><li>• Make sure that the shipping bolts are removed.</li><li>• Make sure the washing machine is not touching any other object.</li><li>• Make sure the laundry load is balanced.</li></ul>
The washing machine does not drain and/or spin	<ul style="list-style-type: none"><li>• Make sure the drain hose is not squashed or bent.</li><li>• Make sure the water hose mesh filter is not clogged.</li></ul>
The Door does not open	<ul style="list-style-type: none"><li>• The door will not open until 3 minutes after the machine stops or the power turns off.</li></ul>

## UNDERSTANDING ERROR MESSAGES

ERROR CODE	SOLUTION
dE	<ul style="list-style-type: none"><li>• Close the door.</li></ul>
4E	<ul style="list-style-type: none"><li>• Make sure the source water faucet is turned on.</li><li>• Check the water pressure.</li></ul>
5E	<ul style="list-style-type: none"><li>• Clean the debris filter.</li><li>• Make sure the drainage hose is installed correctly.</li></ul>
UE	<ul style="list-style-type: none"><li>• Laundry load is unbalanced; loosen any tangled laundry. If only one item of clothing needs washing, such as a bathrobe or jeans, the final spin result might be unsatisfactory and an "UE" error message will be shown in the display window.</li></ul>
cE/3E	<ul style="list-style-type: none"><li>• Call after-sales service.</li></ul>

### Before contacting After-Sales service:

1. Try to remedy the problem (See "Troubleshooting" on this page).
2. Restart the programme to see if the fault is repeated.
3. If the malfunction persists, call after-sales service and describe the problem.

# programme chart

## PROGRAMME CHART

(● user option)





























Program	Max load(kg)				Detergent and additives			Temp (MAX) °C	Spin speed (MAX) rpm				Delay start	Cycle time (min)
	WF 7754N4/7752N4/7750N4/7758N4	WF 7654N4/7652N4/7650N4/7658N4	WF 7522N4/7520N4/7528N4	WF 7452N4/7450N4/7458N4	Prewash	Wash	Softener		WF 7754N4/7654N4	WF 7752N4/7652N4/7522N4/7452N4	WF 7750N4/7650N4/7520N4/7450N4	WF 7758N4/7658N4/7528N4/7458N4		
Cotton	7.5	6.5	5.2	4.5	●	yes	●	95	1400	1200	1000	800+	●	126
Coloureds	7.5	6.5	5.2	4.5	●	yes	●	60	1400	1200	1000	800+	●	99
Synthetics	3.0	3.0	2.5	2.5	●	yes	●	60	800	800	800	800	●	72
Delicates	2.5	2.5	2.0	2.0	●	yes	●	40	800	800	600	600	●	55
Wool	2.0	2.0	1.5	1.5	-	yes	●	40	400	400	400	400	●	40
Handwash	2.0	2.0	1.5	1.5	-	yes	●	40	400	400	400	400	●	35
Quick	3.0	3.0	2.0	2.0	-	yes	●	60	1400	1200	1000	800+	●	47
Baby Cotton	7.5	6.5	5.2	4.5	●	yes	●	95	1400	1200	1000	800+	●	122
Heavy Soil	7.5	6.5	5.2	4.5	●	yes	●	60	1400	1200	1000	800+	●	109
Mixed Load	2.5	2.5	2.0	2.0	●	yes	●	60	800	800	800	800	●	77
Calm Wash	3.0	3.0	2.0	2.0	●	yes	●	40	No Spin				●	98

Program	Type of wash
Cotton	Averagely or lightly soiled cottons, bed linen, table linen, underwear, towels, shirts, etc.
Coloureds	Averagely or lightly soiled cottons, bed linen, table linen, underwear, towels, shirts, etc.
Synthetics	Averagely or lightly soiled blouses, shirts, etc., Made of polyester (diolen, trevira), polyamide (perlon, nylon) or other similar blends.
Delicates	Delicate curtains, dresses, skirts, shirts and blouses.
Wool	Only machine washable woolens with pure new wool label.
Handwash	Very light wash course like hand wash.
Quick	Lightly soiled cottons or linen blouses, shirts, dark coloured terry cloth, coloured linen articles, jeans, etc.
Baby Cotton	Averagely or lightly soiled baby cottons, bed linen, table linen, underwear, towels, shirts, etc.
Heavy Soil	Stained or heavy soiled cottons, bed linen, table linen, underwear, towels, shirts, jeans, etc.
Mixed Load	A mix of lightly soiled cottons and synthetic fabrics.
Calm Wash	Extremely low noise level during the entire cycle and finish rinse hold. Cottons, bed linen, table linen, underwear, towels, shirts.

1. Programme with prewash lasts approx.15 minutes longer.
2. The programme duration data has been measured under the conditions specified in Standard IEC 456.
3. Consumption in individual homes may differ from the values given in the table due to variations in the pressure and temperature of the water supply, the load and the type of laundry.

# appendix

## FABRIC CARE CHART

 Resistant material	 Can be ironed at 100°C max
 Delicate fabric	 Do not iron
  Item may be washed at 95°C	 Can be dry cleaned using any solvent
  Item may be washed at 60°C	 Dry clean with perchloride, lighter fuel, pure alcohol or R113 only
  Item may be washed at 40°C	 Dry clean with aviation fuel, pure alcohol or R113 only
  Item may be washed at 30°C	 Do not dry clean
 Item may be hand washed	 Dry flat
 Dry clean only	 Can be hung to dry
 Can be bleached in cold water	 Dry on clothes hanger
 Do not bleach	 Tumble dry, normal heat
 Can be ironed at 200°C max	 Tumble dry, reduced heat
 Can be ironed at 150°C max	 Do not tumble dry

## ELECTRICAL WARNINGS

To reduce the risk of fire, electrical shock, and other injuries, keep these safety precautions in mind:

- Operate the appliance only from the type of power source indicated on the marking label. If you are not sure of the type of power supplied to your home, consult your appliance dealer or local power company.
- Use only a grounded or polarized outlet. This plug will fit into the power outlet only one way. If you are unable to insert the plug fully into the outlet, try reversing the plug. If the plug still doesn't fit, contact your electrician to replace your outlet.
- Protect the power cord. Power supply cords should be routed so that they are unlikely to be walked on or pinched by items placed on or against them. Pay particular attention to cords at plugs, convenience receptacles, and the point where they exit from the unit.
- Do not overload the wall outlet or extension cords. Overloading can result in fire or electric shock.

## PROTECTING THE ENVIRONMENT

- This appliance is manufactured from recyclable materials. If you decide to dispose of this appliance, please observe local waste disposal regulations. Cut off the power cord so that the appliance cannot be connected to a power source. Remove the door so that animals and small children cannot get trapped inside the appliance.
- Do not exceed the detergent quantities recommended in the detergent manufacturers' instructions.
- Use stain removal products and bleaches before the wash cycle only when strictly necessary.
- Save water and electricity by only washing full loads (the exact amount depends upon the program used).

# appendix

## DECLARATION OF CONFORMITY

This appliance complies with European safety standards, EC directive 93/68 and EN Standard 60335.

## SPECIFICATION

TYPE		FRONT LOADING WASHER								
DIMENSION	WF7754N4/WF7752N4/ WF7750N4/WF7758N4				WF7654N4/WF7652N4/WF7650N4/ WF7658N4					
	W598mm × D600mm × H844mm				W598mm × D550mm × H844mm					
WATER PRESSURE		50 kPa ~ 800 kPa								
WATER VOLUME		60 ℓ				54 ℓ				
NET WEIGHT	WF7754N4/ WF7752N4		WF7750N4/ WF7758N4		WF7654N4/ WF7652N4		WF7650N4/ WF7658N4			
	71 kg		70 kg		71 kg		70 kg			
WASH and SPIN CAPACITY		7.5 kg (DRY LAUNDRY)				6.5 kg (DRY LAUNDRY)				
POWER CONSUMPTION	MODEL		WF7754N4/WF7752N4/ WF7750N4/WF7758N4				WF7654N4/WF7652N4/WF7650N4/ WF7658N4			
	WASHING AND HEATING		220 V		2000 W		220 V		2000 W	
			240 V		2400 W		240 V		2400 W	
	SPIN	MODEL	WF7754N4	WF7752N4	WF7750N4	WF7758N4	WF7654N4	WF7652N4	WF7650N4	WF7658N4
		230 V	700 W	360 W	320 W	270 W	580 W	530 W	500 W	430 W
PUMPING		34 W								
PACKAGE Wt	MODEL		WF7754N4/WF7752N4/WF7750N4/ WF7758N4				WF7604N4/WF7602N4/WF7600N4/ WF7608N4			
	PAPER		2.5 kg				2.5 kg			
	PLASTIC		1.0 kg				1.0 kg			
SPIN REVOLUTION	MODEL		WF7754N4/WF7654N4				WF7752N4/WF7652N4/ WF7522N4/WF7452N4			
	rpm		1400				1200			

TYPE		FRONT LOADING WASHER						
DIMENSION	WF7522N4/WF7520N4/ WF7528N4			WF7452N4/WF7450N4/ WF7458N4				
	W598mm × D450mm × H844mm			W598mm × D404mm × H844mm				
WATER PRESSURE		50 kPa ~ 800 kPa						
WATER VOLUME		49 ℓ			48 ℓ			
NET WEIGHT	WF7522N4	WF7520N4/WF7528N4		WF7452N4/WF7450N4/WF7458N4				
	67 kg	66 kg		62kg				
WASH and SPIN CAPACITY		5.2 kg (DRY LAUNDRY)			4.5 kg (DRY LAUNDRY)			
POWER CONSUMPTION	MODEL	WF7522N4/WF7520N4/ WF7528N4			WF7452N4/WF7450N4/ WF7458N4			
	WASHING AND HEATING	220 V	1900 W		220 V	1800 W		
		240 V	2200 W		240 V	2100 W		
	SPIN	MODEL	WF7522N4	WF7520N4	WF7528N4	WF7452N4	WF7450N4	WF7458N4
		230 V	550 W	500 W	430 W	270 W	230 W	180 W
PUMPING		34 W						
PACKAGE Wt	MODEL	WF7522N4/WF7520N4/ WF7528N4			WF7452N4/WF7450N4/ WF7458N4			
	PAPER	2.1 kg			1.9 kg			
	PLASTIC	0.9 kg			0.8 kg			
SPIN REVOLUTION	MODEL	WF7700N4/WF7600N4/WF7520N4/ WF7450N4			WF7708N4/WF7608N4/WF7528N4/ WF7458N4			
	rpm	1000			800			



QUESTIONS OR COMMENTS?

<b>Country</b>	<b>CALL</b>	<b>OR VISIT US ONLINE AT</b>
THAILAND	1800-29-3232 02-689-3232	<a href="http://www.samsung.com/th">www.samsung.com/th</a>