

JVC

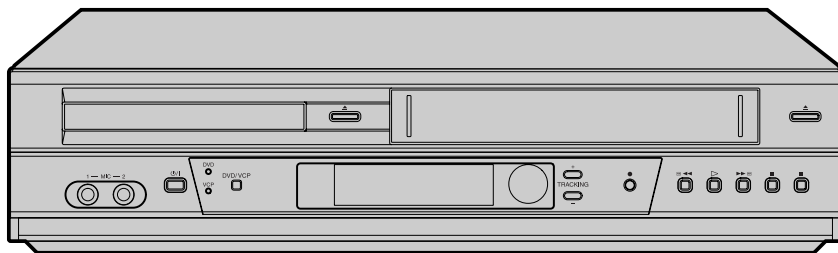

**DVD PLAYER/Hi-Fi STEREO
KARAOKE VIDEO CASSETTE PLAYER**

HR-XV10AG



INSTRUCTIONS

LPT0777-001C

EN

Safety Precautions

The rating plate and the safety caution are on the rear of the unit.

WARNING: DANGEROUS VOLTAGE INSIDE
WARNING: TO PREVENT FIRE OR SHOCK HAZARD, DO NOT EXPOSE THIS UNIT TO RAIN OR MOISTURE.

The STANDBY/ON \cup/I button does not completely shut off mains power from the unit, but switches operating current on and off.

This unit is produced to comply with Standard IEC 60065.

When the equipment is installed in a cabinet or a shelf, make sure that it has sufficient space on all sides to allow for ventilation (10 cm or more on both sides, on top and at the rear).

When discarding batteries, environmental problems must be considered and the local rules or laws governing the disposal of these batteries must be followed strictly.

Failure to heed the following precautions may result in damage to the player, remote control or video cassette.

1. **DO NOT** place the player ...
 - ...in an environment prone to extreme temperatures or humidity.
 - ...in direct sunlight.
 - ...in a dusty environment.
 - ...in an environment where strong magnetic fields are generated.
 - ...on a surface that is unstable or subject to vibration.
2. **DO NOT** block the player's ventilation openings or holes.
(If the ventilation openings or holes are blocked by a newspaper or cloth, etc., the heat may not be able to get out.)
3. **DO NOT** place heavy objects on the player or remote control.
4. **DO NOT** place anything which might spill on top of the player or remote control.
(If water or liquid is allowed to enter this equipment, fire or electric shock may be caused.)
5. **DO NOT** expose the apparatus to dripping or splashing.
6. **DO NOT** use this equipment in a bathroom or places with water. Also **DO NOT** place any containers filled with water or liquids (such as cosmetics or medicines, flower vases, potted plants, cups, etc.) on top of this unit.
7. **DO NOT** place any naked flame sources, such as lighted candles, on the apparatus.
8. **AVOID** violent shocks to the player during transport.

Beware of moisture condensation

Moisture in the air will condense on the player when you move it from a cold place to a warm place, or under extremely humid conditions—just as water droplets form on the surface of a glass filled with cold liquid. Moisture condensation on the head drum will cause damage to the tape. In conditions where condensation may occur, keep the player's power turned on for a few hours to let the moisture dry.

When transporting

- Be sure to remove cassette from player before packing.
- Avoid violent shocks to the player during packing and transport.

Video heads cleaning

Accumulation of dirt and other particles on the video heads may cause the playback picture to become blurred or interrupted. Clean the video heads using a dry cleaning cassette or be sure to contact your nearest JVC dealer if such troubles occur.

You can check the video head status by using the Video Doctor function. See page 24.

Usable cassettes

- Compact VHS camcorder recordings can be played on this player. Simply place the recorded cassette into a VHS Cassette Adapter and it can be used just like any full-sized VHS cassette.
- This player can record on regular VHS and Super VHS cassettes. However, it will record and play back regular VHS signals only. It is not possible to play back a recorded Super VHS cassette.

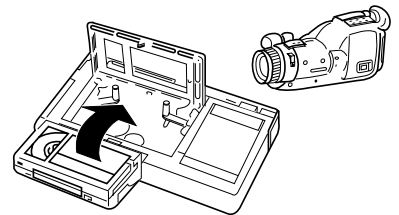

ATTENTION:

To mobile phone users:

Using a mobile phone in the vicinity of the player may cause picture vibration on the screen or change the screen to a blue back display.

On placing the player:

Some TVs or other appliances generates strong magnetic fields. Do not place such appliance on top of the player as it may cause picture disturbance.

CAUTION:

A DVD/VCP IS A CLASS 1 LASER PRODUCT. HOWEVER THIS DVD/VCP USES A VISIBLE LASER BEAM WHICH COULD CAUSE HAZARDOUS RADIATION EXPOSURE IF DIRECTED. BE SURE TO OPERATE THE PLAYER CORRECTLY AS INSTRUCTED.

THE FOLLOWING CAUTION LABEL IS LOCATED ON THE REAR PANEL OF THE DVD/VCP.

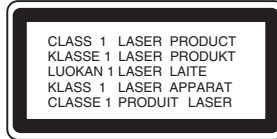

WHEN THIS DVD/VCP IS PLUGGED INTO THE WALL OUTLET, DO NOT PLACE YOUR EYES CLOSE TO THE OPENING OF THE DISC TRAY AND OTHER OPENINGS TO LOOK INTO THE INSIDE OF THIS DVD/VCP.

USE OF CONTROLS OR ADJUSTMENTS OR PERFORMANCE OF PROCEDURES OTHER THAN THOSE SPECIFIED HEREIN MAY RESULT IN HAZARDOUS RADIATION EXPOSURE.

DO NOT OPEN COVERS AND DO NOT REPAIR YOURSELF. REFER SERVICING TO QUALIFIED PERSONNEL.

Contents

Introduction

Safety Precautions	2
Table of Contents	4
Before Use	5-6
Playable Discs	5
Precautions	6
Notes on Discs	6
About Symbols	6
Front Panel and Display Window	7
Remote Control	8-9
Rear Panel	10

Preparation

Connections	11-12
Connecting to a TV	11
Connecting to Optional Equipment	12
Before Operation - VCP part	13
How to using the main menu	13
Before Operation - DVD part	14-17
General Explanation	14
On-Screen Display	14
Initial Settings	15-17
• Initial Settings General Operation	15
• Language	15
• Picture	15
• Sound	16
• Others (DRC/Vocal/PBC)	16
• Parental Control	17

Operation

Operation with tape	18
Playing a tape	18
• CM (Commercial Message) Skip	18
• OPR (Optimum Picture Response)	18
Operation with DVD and Video CD	19-21
Playing a DVD and Video CD	19
General Features	19
• Moving to another TITLE	19
• Moving to another CHAPTER/TRACK	19
• Slow Motion	19
• Still Picture and Frame-by-frame playback	20
• Search	20
• Random	20
• Repeat	20
• Repeat A-B	20
• Time Search	20
• 3D Surround	20
• Zoom	21
• Marker Search	21
Special DVD Features	21
• Title Menu	21
• Disc Menu	21
• Camera Angle	21
• Changing the Audio Language	21
• Subtitles	21

Operation with Audio CD and MP3 Discs	22
Playing an Audio CD and MP3 Discs	22
• Pause	22
• Moving to another Track	22
• Repeat Track/All/Off	22
• Search	22
• Random	22
• Repeat A-B	22
• 3D Surround	22
• Changing the Audio Channel	22
Programmed Playback	23
Programmed Playback with Audio CD and MP3 Discs	23
Programmed Playback with Video CD	23
• Repeat Programmed Tracks	23
• Erasing a Track from Program List	23
• Erasing the Complete Program List	23
Additional Operation - VCP part	24
On Screen Display	24
Tape Counter Memory Stop	24
Video Doctor (Self-Diagnosis)	24
Hi-Fi Stereo Sound System	24
Additional Operation - DVD part	25
Last Condition Memory	25
Screen Saver	25
Video Mode Setting	25
Notes on MP3 Discs	25
Special Operation - Karaoke function	26
Before you start karaoke	26
Karaoke sing-along	26
Grading your singing	26
Special Recording	27
Copying from DVD to VCP	27
Recording from another video player	27

Reference

Troubleshooting	28
Language Code List	29
Country Code List	30
Specification	31



About the symbols for instructions

 Indicates hazards likely to cause harm to the unit itself or other material damage.

 Indicates special operating features of this unit.

 Indicates tips and hints for making the task easier.

Playable Discs

	DVD (8 cm / 12 cm disc)
	Video CD (VCD) (8 cm / 12 cm disc)
	Audio CD (8 cm / 12 cm disc)

In addition, this unit can play a CD-R or CD-RW that contains audio titles or MP3 files.

Notes

- Depending on the conditions of the recording equipment or the CD-R/RW disc itself, some CD-R/RW discs cannot be played on the unit.
- The unit cannot play the CD-R/RW discs that contain no data, or contain different kinds of formatted data other than MP3 and CD-DA data.
- Do not attach any seal or label to either side (the labeled side or the recorded side) of a disc.
- Do not use irregular shaped CDs (e.g., heart-shaped or octagonal). It may result in malfunctions.

Notes on DVDs and Video CDs

Some playback operations of DVDs and Video CDs may be intentionally fixed by software manufacturers. As this unit plays DVDs and Video CDs according to disc content designed by the software manufacturer, some playback features of the unit may not be available, or other functions may be added. Refer also to the instructions applied with the DVDs and Video CDs. Some DVDs made for business purposes may not be played on the unit.

Regional code of the DVD player and DVDs

This DVD player is designed and manufactured for playback of region “2” encoded DVD software. The region code on the labels of some DVD discs indicates which type of player can play those discs. This unit can play only DVD discs labeled “2” or “ALL”. If you try to play any other discs, the message “Check Regional Code” will appear on the TV screen. Some DVD discs may not have a region code label even though their playback is prohibited by area limits.



Disc-related terms

Title (DVD only)

The main film content or accompanying feature content or additional feature content, or music album. Each title is assigned a title reference number enabling you to locate it easily.

Chapter (DVD only)

Sections of a picture or a musical piece that are smaller than titles.

A title is composed of one or several chapters. Each chapter is assigned a chapter number, enable you to locate the chapter you want. Depending on the disc, no chapters may be recorded.

Track (Video CD and audio CD only)

Sections of a picture or a musical piece on a video CD or an audio CD. Each track is assigned a track number, enabling you to locate the track you want.

Scene

On a video CD with PBC (Playback control) functions, moving pictures and still pictures are divided into sections called “Scenes”. Each scene is displayed in the menu screen and assigned a scene number, enabling you to locate the scene you want. A scene is composed of one or several tracks.

Types of video CDs

There are two types of video CDs:

Video CDs equipped with PBC (Version 2.0)

PBC (Playback control) functions allow you to interact with the system via menus, search functions, or other typical computer-like operations. Moreover, still pictures of high resolution can be played if they are included in the disc.

Video CDs not equipped with PBC (Version 1.1)

Operated in the same way as audio CDs, these discs allow playback of video pictures as well as sound, but they are not equipped with PBC.

Before Use (Cont'd)

Precautions

Handling the unit

When shipping the unit

The original shipping carton and packing materials come in handy. For maximum protection, re-pack the unit as it was originally packed at the factory.

When setting the unit

The picture and sound of a nearby TV or radio may be distorted during playback. In this case, position the unit away from the TV or radio, or turn off the unit after removing the disc.

To keep the surface clean

Do not use volatile liquids, such as insecticide spray, near the unit. Do not leave rubber or plastic products in contact with the unit for a long period of time. They will leave marks on the surface.

Cleaning the unit

To clean the cabinet

Use a soft, dry cloth. If the surfaces are extremely dirty, use a soft cloth lightly moistened with a mild detergent solution. Do not use strong solvents, such as alcohol, benzene, or thinner, as these might damage the surface of the unit.

To obtain a clear picture

The DVD player is a high-tech, precision device. If the optical pick-up lens and disc drive parts are dirty or worn down, the picture quality will be poor. Regular inspection and maintenance are recommended after every 1,000 hours of use. (This depends on the operating environment.)
For details, please contact your nearest dealer.

Notes on Discs

Handling discs

Do not touch the playback side of the disc.
Hold the disc by the edges so that fingerprints will not get on the surface.
Do not stick paper or tape on the disc.

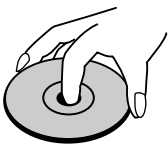

Storing discs

After playing, store the disc in its case.
Do not expose the disc to direct sunlight or sources of heat, or leave it in a parked car exposed to direct sunlight, as there may be a considerable temperature increase inside the car.

Cleaning discs

Fingerprints and dust on the disc can cause poor picture quality and sound distortion. Before playing, clean the disc with a clean cloth. Wipe the disc from the center out.

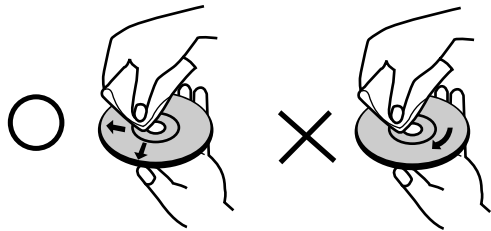

Do not use strong solvents such as alcohol, benzene, thinner, commercially available cleaners, or anti-static spray intended for older vinyl records.

About Symbols

About the symbol display

“” may appear on the TV screen during operation. This icon means the function explained in this owner's manual is not available on that specific DVD video disc.

About the disc symbols for instructions

A section whose title has one of the following symbol is applicable only to the disc represented by the symbol.

 DVD

 Video CDs with the PBC (playback control) function.

 Video CDs without the PBC (playback control) function.

 Audio CDs.

 MP3 disc.

Front Panel and Display Window

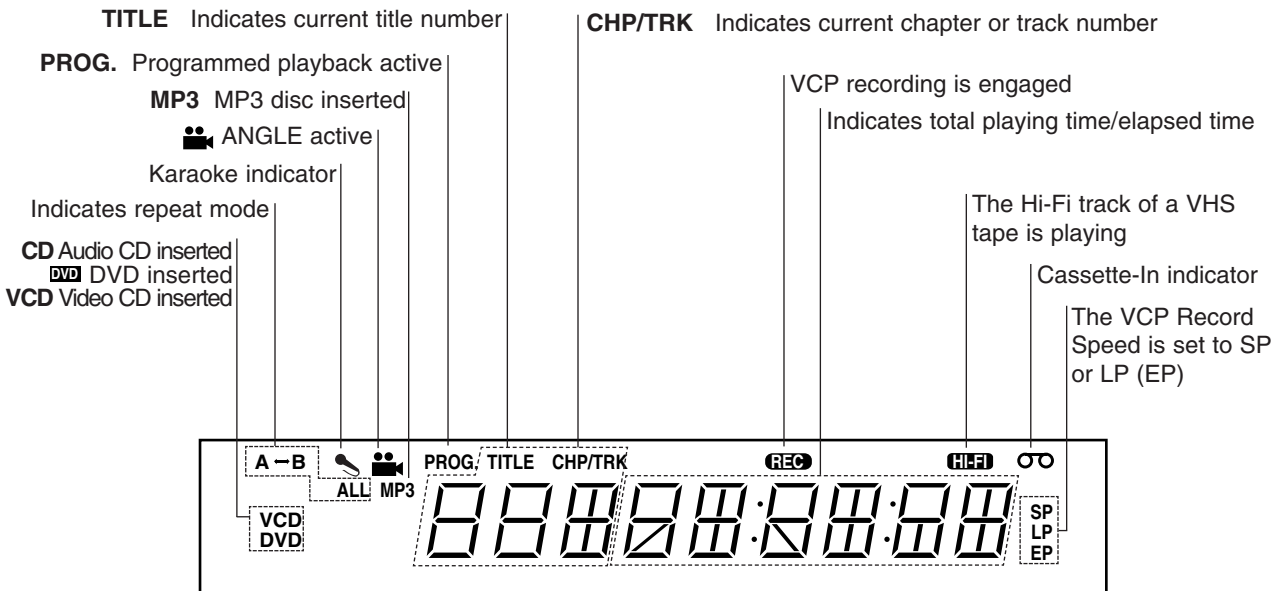
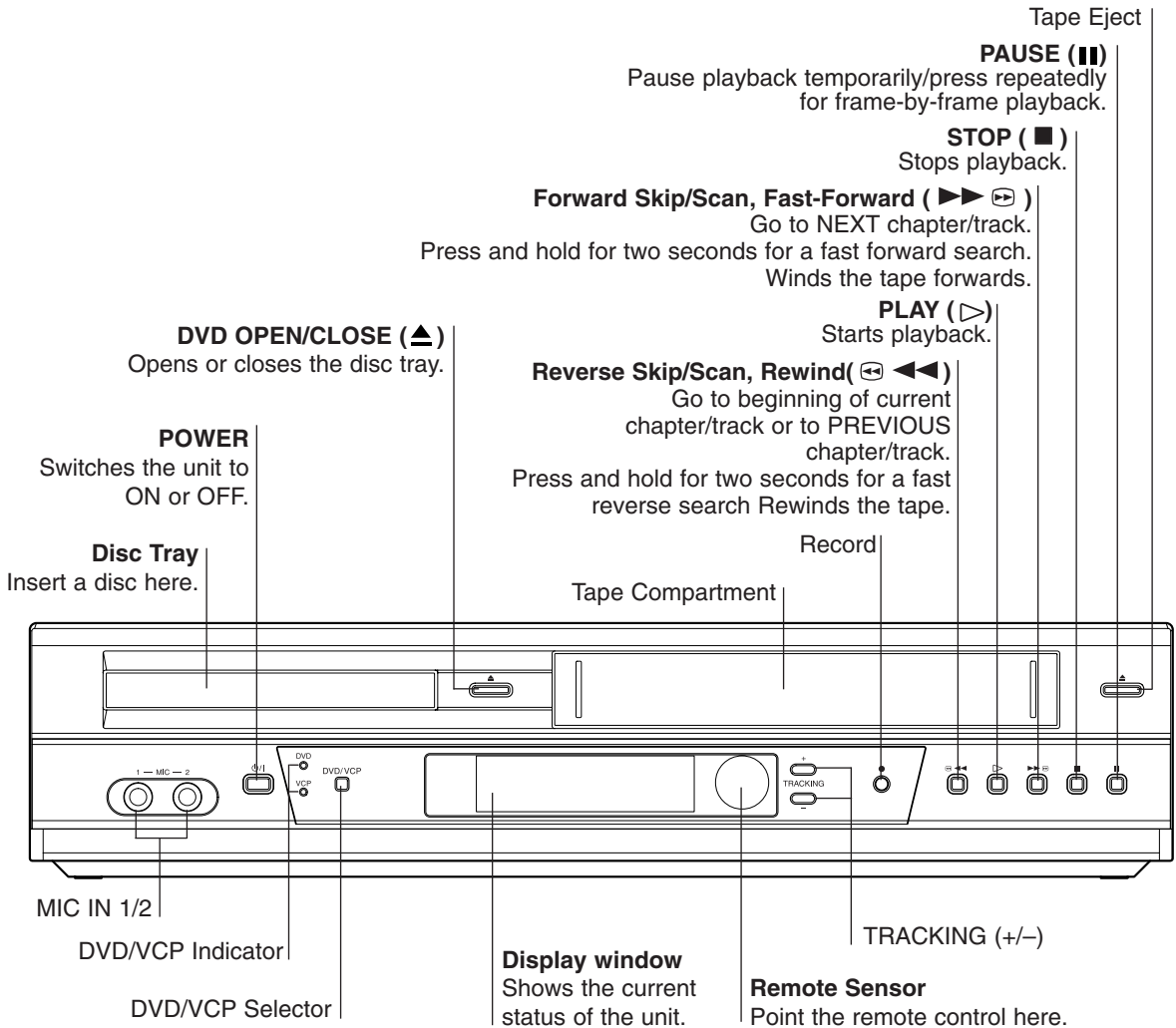

Remote Control

DVD/VCP select button
Selects operational mode of remote control.

POWER
Switch this unit ON or OFF.

DISPLAY COUNT
Access the On-Screen Display.
Shows you the counter.

◀ ▶ ▲ ▼ (left/right/up/down)
- Select an item in the menu
- Perform the Karaoke Search.

SETUP/ MENU
Access or remove setup menu.

TITLE •
Display the title menu of the disc if available.

PAUSE/STEP (II) •
Pause playback temporarily / press repeatedly for frame-by-frame playback.

STOP (■) •
Stops playback.

0-9 numerical buttons
Select numbered items in a menu.

A. MONITOR •
Select an audio language (DVD) or an audio channel (CD).

SUBTITLE •
Select a subtitle language.

MARKER •
Mark any point during playback.

SEARCH •
Display MEMORY SEARCH menu.

MIC/ECHO •
To select the MIC/ECHO mode

RETURN •
- Remove the setup menu.
- Displays the menu of a video CD with PBC.

KARAOKE
Switch Karaoke on and off.

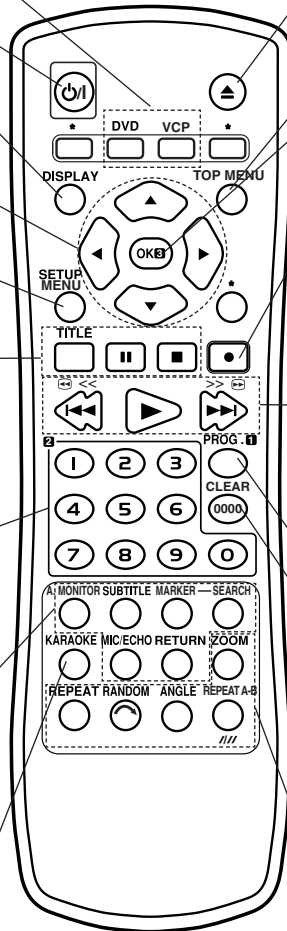

OPEN/CLOSE EJECT
- Open or close the disc tray.
- Tape Eject.

TOP MENU
Access menu of a DVD disc.

SELECT/ENTER/OK
Acknowledge menu selection.

REC
Record your input sources into tape.

• Forward SKIP/SCAN (▶▶I) / Fast - Forward
- Search forward* / go to next chapter or track.
- Winds the tape forwards.

❖ Press and hold button for about two seconds.

• PLAY (▶)
Starts playback.

• Reverse SKIP/SCAN (I◀◀) / Rewind
- Search backward* / go to beginning of current chapter or track or go to previous chapter or track.
- Rewinds the tape.

❖ Press and hold button for about two seconds.

PROGRAM
Access or remove program menu.

CLEAR
- Clear a track number on the program menu or a mark on the MARKER SEARCH menu.
- Reset tape counter to zero.

• REPEAT
- Repeat chapter, track, title, all.

• RANDOM
- Play tracks in random order.
- CM Skip

• ANGLE
Select DVD camera angle if available

• REPEAT A-B/LP
- Repeat sequence.
- Select the recording speed of the tape.

• ZOOM
Enlarge video image.

* Feature is not available.

Remote Control (Cont'd)

Remote Control Operation Range

Point the remote control at the remote sensor and press the buttons.

- **Distance:** About 7 m from the front of the remote sensor
- **Angle:** About 30° in each direction of the front of the remote sensor

Remote control battery installation

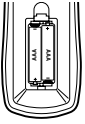

Detach the battery cover on the rear of the remote control, and insert two R03 (size AAA) batteries with \oplus and \ominus aligned correctly.

Caution

Do not mix old and new batteries. Never mix different types of batteries (standard, alkaline, etc.).

Remote A/B Code Switching

The remote control is capable of controlling two JVC units independently; one set to respond to the remote control's A code control signals and another set to respond to B code control signals. The remote control is preset to send A code signals because your unit is initially set to respond to A code signals. You can easily change your unit to respond to B code signals.

- 1** Press and hold **VCP** on the remote control for over 2 seconds, press the **number key "2"** and then press **OK**. The remote control now can transmit B code signals.
- 2** Press and hold **PLAY ►** on the unit for more than 5 seconds while the unit is turned off. The code currently set appears on the display window.
- 3** Press any key on the remote control. The unit will now only respond to B code signals.

Notes

- To set the unit back to respond to A code signals, repeat the same procedure as shown above, but in step **1**, press the **number key "1"** instead of "2".
- The code for the unit will be back to respond A code signals once you disconnect the AC power cord.

Rear Panel

AUDIO OUT (Left/Right)

Connect to an amplifier, receiver or stereo system.

COAXIAL (Digital audio out jack)

Connect to digital (coaxial) audio equipment.

AUDIO OUT L/R (Both DVD and VHS out)

Connect to an amplifier, receiver or stereo system.

AUDIO IN L/R (VHS IN)

Receive the audio signals from an external source to VCP.

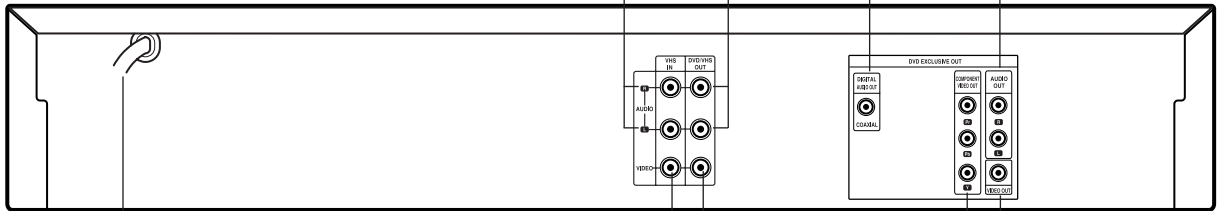

AC Power Cord

Connect to a power source.

VIDEO IN (VHS IN)

Receive the video signals from an external source to VCP.

VIDEO OUT (Both DVD and VHS out)

Connect to a TV with video inputs.

COMPONENT VIDEO OUT (Y Pb Pr) (DVD OUT)

Connect to a TV with Y Pb Pr inputs.

VIDEO OUT

Connect to a TV with video inputs.



Do not touch the inner pins of the jacks on the rear panel. Electrostatic discharge may cause permanent damage to the unit.

Connections

Tips

- Depending on your TV and other equipment you wish to connect, there are various ways you could connect the unit.
- Please refer to the manuals of your TV, Stereo System or other devices as necessary to make the best connections.
- For better sound reproduction, connect this unit's AUDIO OUT jacks to the audio in jacks of your amplifier, receiver, stereo or audio/video equipment. See "Connecting to optional equipment" on page 12.

Caution

- Make sure this unit is connected directly to the TV. Set the TV to the correct video input channel.
- Do not connect this unit's AUDIO OUT jack to the phono in jack (record deck) of your audio system.

Connecting to a TV

- Make one of the following connections, depending on the capabilities of your existing equipment.
- When using the COMPONENT VIDEO OUT jacks, set TV's INPUT to COMPONENT VIDEO.

Basic connection (AV)

- 1 Connect the VIDEO OUT jack on this unit's DVD/VHS OUT to the video in jack on the TV using the video cable supplied.
- 2 Connect the Left and Right AUDIO OUT jacks of this unit's DVD/VHS OUT to the audio left/right in jacks on the TV using the supplied audio cables.

Component Video (Color Stream®) connection (for DVD)

- 1 Connect the COMPONENT VIDEO OUT jacks on the unit to the corresponding in jacks on the TV using an optional Y Pb Pr cable.
- 2 Connect the Left and Right AUDIO OUT jacks of the unit to the audio left/right in jacks on the TV using the audio cables.

DVD exclusive out connection

- You can only watch the DVD playback.

- 1 Connect the VIDEO OUT jack on this unit's DVD EXCLUSIVE OUT to the video in jack on the TV using the video cable.
- 2 Connect the Left and Right AUDIO OUT jacks of this unit's DVD EXCLUSIVE OUT to the audio left/right in jacks on the TV using the audio cables.

Rear of this unit (DVD exclusive out connection)

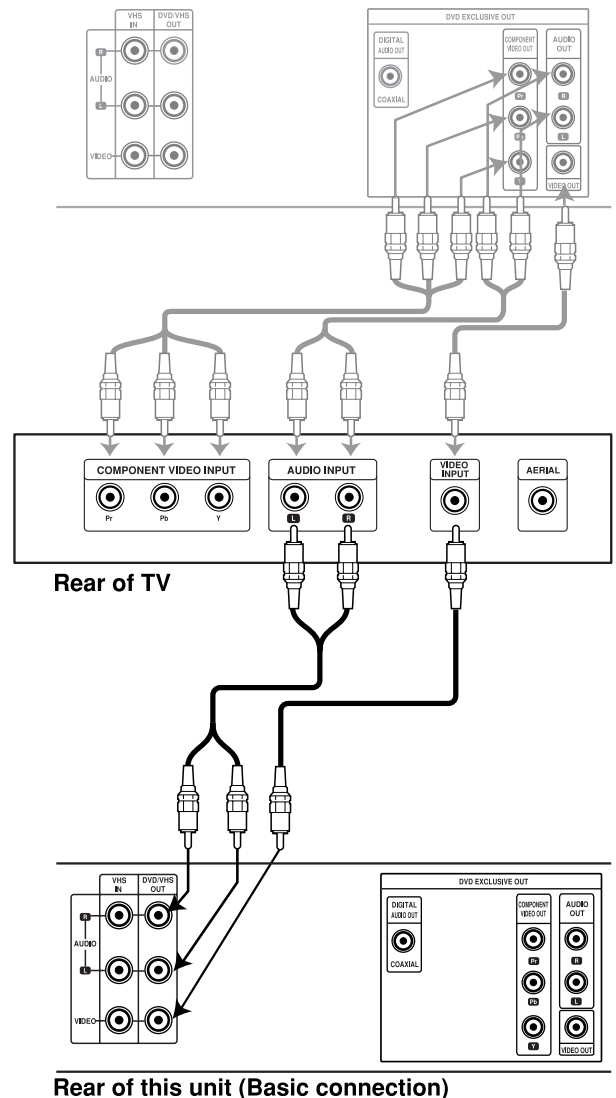

Connecting to Optional Equipment

Connecting to an amplifier equipped with two channel analog stereo or Dolby Surround

Connect the Left and Right AUDIO OUT jacks on this unit to the audio left and right in jacks on your amplifier, receiver or stereo system, using the audio cables.

Connecting to an amplifier equipped with two channel digital stereo (PCM) or to an Audio/Video receiver equipped with a multi-channel decoder (Dolby Digital™, MPEG 2 or DTS)

- 1 Connect this unit's DIGITAL AUDIO OUT jack (COAXIAL) to the corresponding in jack on your amplifier. Use an optional coaxial audio cable.
- 2 You will need to activate this unit's digital output. (See "Digital Audio Output" on page 16).

Digital Multi-channel sound

A digital multi-channel connection provides the best sound quality. For this you need a multi-channel Audio/Video receiver that supports one or more of the audio formats supported by your unit (MPEG 2, Dolby Digital and DTS). Check the receiver manual and the logos on the front of the receiver.

Warning:

Due to the DTS Licensing agreement, the digital output will be in DTS digital out when DTS audio stream is selected.

Notes

- If the audio format of the digital output does not match the capabilities of your receiver, the receiver will produce a strong, distorted sound or no sound at all.
- To see the audio format of the current DVD in the On-Screen Display, press **A. MONITOR**.

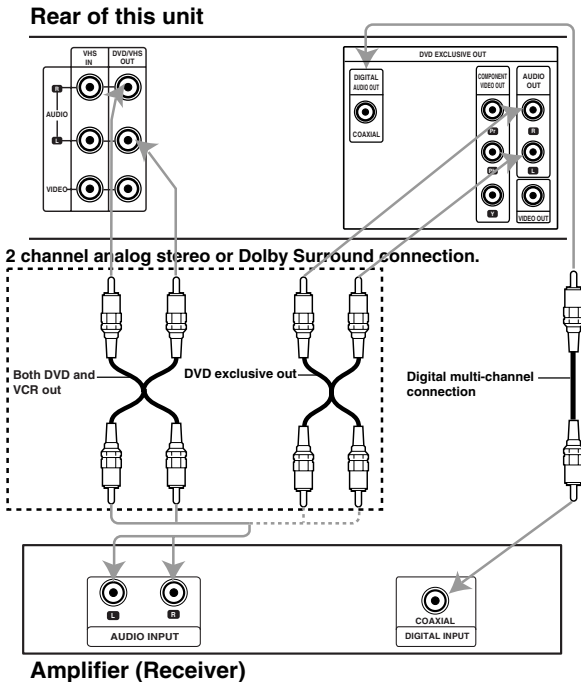

Before Operation - VCP part

How to using the main menu

This VCP can easily be programmed by using the menus displayed on screen.

The menus are controlled from the Remote Control Handset.

- 1** Switch on your TV set and video player by pressing ψ/I .
- 2** Press **VCP**.
- 3** Press **MENU**.
The main menu will appear on the TV screen.

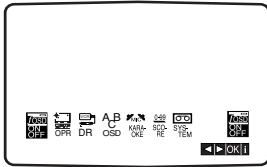

- **F.OSD ON/OFF** - To switch the display of operational mode of your VCP ON or OFF (see p 24).
- **OPR** - To improve the playback picture (see p 18).
- **DR** - To check a problem with your VCP (see p 24).
- **ABC OSD** - To change the language setting for OSD.
You can select the language between English and Russian.
- **KARAOKE** - To switch on or off Karaoke & Karaoke Search (see p 26).
- **SCORE** - To display the score your song when you Karaoke (see p 26).
- **SYSTEM** - Select the colour system used for playback and recording.
The system is changed as shown below. (Refer to the right for more information.)
*If you want to record NTSC signals, press **OK** and select between NTSC 3.58 and NTSC 4.43.

Source	Mode	System Change
PAL/ MESECAM	Recording	AUTO → PAL → MESECAM
	Playback	AUTO → PAL → MESECAM
NTSC	Recording	NTSC3.58 → NTSC4.43*
	Playback	NTSC-PB → NTSC3.58 → NTSC4.43

- 4** Press \blacktriangleleft and \blacktriangleright to select the option to change, then Press **OK** to change the setting and press \blacktriangleleft and \blacktriangleright to select the sub menu.
- 5** Press **MENU** to remove the menu screen.

To set the colour system

If streaks appear during playback, set colour system manually to conform to the system that the tape was recorded in. (Normally set the switch to AUTO.)

If your tape was recorded in	Set colour system to	If your TV is
PAL	PAL	
NTSC3.58	NTSC3.58	MULTI-SYSTEM TV
	NTSC-PB	PAL TV
NTSC4.43	NTSC4.43	MULTI-SYSTEM TV
	NTSC-PB	PAL TV
MESECAM	MESECAM	MULTI-SYSTEM TV

Before Operation - DVD part

General Explanation

This manual gives the basic instructions for operating this unit. Some DVDs require specific operation or allow only limited operation during playback. When this occurs, the symbol  appears on the TV screen, indicating that the operation is not permitted by this unit or is not available on the disc.









On-Screen Display

The general playback status can be displayed on the TV screen. Some items can be changed on the menu.

On-screen display operation

- 1** Press **DISPLAY** during playback.
- 2** Press **▲** or **▼** to select an item.
The selected item will be highlighted.
- 3** Press **◀** or **▶** to change the setting of an item.
The number buttons can be also be used for setting numbers (e.g., title number). For some functions, press **OK** to execute the setting.







Temporary Feedback Field Icons

-  TITLE Repeat Title
-  CHAPT Repeat Chapter
-  TRACK Repeat Track (non-PBC Video CDs only)
-  ALL Repeat All Tracks (non-PBC Video CDs only)
-  A B Repeat A-B
-  OFF Repeat Off
-  Resume play from this point
-  Action prohibited or not available





Notes

- Some discs may not provide all of the below On-Screen Display.
- If no button is pressed for 10 seconds, the On-Screen Display disappears.

DVD

Items		Function (Press ▲/▼ to select desired item)	Selection Method
Title Number	 1/3	Shows the current title number and total number of titles, and skips to the desired title number.	◀ / ▶, or Numbers, OK
Chapter Number	 1/12	Shows the current chapter number and total number of chapters, and skips to the desired chapter number.	◀ / ▶, or Numbers, OK
Time search	 0:16:57	Shows the elapsed playing time, and searches the point by the elapsed time directly.	Numbers, OK
Audio language and Digital Audio Output mode	 1 ENG □□□ 5.1 CH	Shows the current audio soundtrack language, encoding method, and channel number, and changes the setting.	◀ / ▶
Subtitle language	 OFF	Shows the current subtitles language, and changes the setting.	◀ / ▶
Angle	 1/1	Shows the current angle number and total number of angles, and changes the angle number.	◀ / ▶
Sound	 NORM.	Shows the current sound mode, and changes the setting.	◀ / ▶

VCD2.0 VCD1.1

Items		Function (Press ▲/▼ to select desired item)	Selection Method
Track Number	 1/4	Shows the current track number, total number of tracks and PBC On mode, and skip to the desired track number.	◀ / ▶, or Numeric, OK
Time	 0:16:57	Shows the elapsed playing time (Display only)	–
Audio Channel	 STER.	Shows the audio channel, and changes the audio channel.	◀ / ▶
Sound	 NORM.	Shows the current sound mode, and changes the setting.	◀ / ▶

Before Operation - DVD part (Cont'd)

Initial Settings

You can set your own Personal Preferences on this unit.

Initial Settings General Operation

- 1 Press SETUP.**
The setup menu appears.



- 2 Press ▲/▼ to select the desired item.**
The screen will show the current setting for the selected item, as well as alternate setting(s).
- 3 While the desired item is selected, press ►, then ▲/▼ to select the desired setting.**
- 4 Press OK to confirm your selection.**
Some items require additional steps.
- 5 Press SETUP, RETURN or PLAY ► to exit the setup menu.**

Language

Disc Language **DVD**

Select a language for the disc's Menu, Audio and Subtitle.

Original : The original language set for the disc is selected.

Other : To select another language, press number buttons to enter the corresponding 4-digit number according to the language code list on page 29. If you enter the wrong language code, press **CLEAR**.



Menu Language

Select a language for the setup menu. This is the menu you see when you press **SETUP**.



Picture

TV Aspect **DVD**

4:3 Letterbox: Select when a standard 4:3 TV is connected. Displays theatrical images with masking bars above and below the picture.

4:3 Panscan: Select when a standard 4:3 TV is connected. Displays pictures cropped to fill your TV screen. Either sides of the picture are cut off.

16:9 Wide: Select when a 16:9 wide TV is connected.

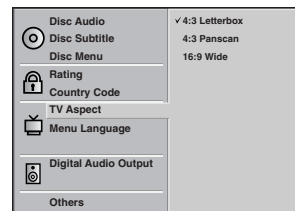

Before Operation - DVD part (Cont'd)

Sound

Digital Audio Output

Each DVD disc has a variety of audio output options. Set this unit's Digital Audio Output according to the type of audio system you use.

DOLBY DIGITAL/PCM: Select "DOLBY DIGITAL/PCM" if you connected this unit's DIGITAL OUT jack to a Dolby Digital decoder (or an amplifier or other equipment with a Dolby Digital decoder).

Stream/PCM: Select "Stream/PCM" if you connected this unit's DIGITAL OUT jack to an amplifier or other equipment with a DTS decoder, Dolby Digital decoder or MPEG decoder.

PCM: Select when connected to a 2 channel digital stereo amplifier. This unit outputs sounds in the PCM 2ch format when you play a DVD video disc recorded on the Dolby Digital, MPEG1 or MPEG2 recording system.

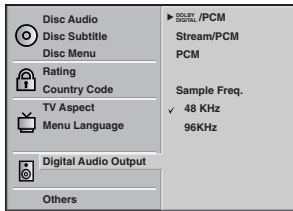

Sample Frequency

To change the Sample Frequency setting, first select the desired Digital Audio Output as indicated as above. If your receiver or amplifier is NOT capable of handling 96KHz signals, select 48KHz. When this choice is made, this unit will automatically convert any 96KHz signals to 48KHz so your system can decode them. If your receiver or amplifier is capable of handling 96KHz signals, select 96KHz. When this choice is made, this unit will pass each type of signal through without any further processing.

Others

The DRC, Vocal, and PBC settings can be changed.

- Press ▲/▼ to select the desired item and press **OK**. The setting of the selected item is changed between On and Off.

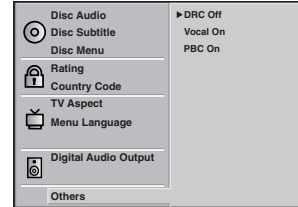

Dynamic Range Control (DRC)

With the DVD format, you can hear a program's soundtrack in the most accurate and realistic presentation possible, thanks to digital audio technology. However, you may wish to compress the dynamic range of the audio output (the difference between the loudest sounds and the quietest ones). Then, you may listen to a movie at a lower volume without losing clarity of sound. Set DRC to On for this effect.

Vocal

Set Vocal to On only when a multi-channel karaoke DVD is playing. The karaoke channels on the disc will mix into a normal stereo sound.

PBC

Set Playback Control (PBC) to On or Off.

- On:** Video CDs with PBC are played according to the PBC.
- Off:** Video CDs with PBC are played the same way as Audio CDs.

Before Operation - DVD part (Cont'd)

Parental Control

Rating **DVD**

Movies on DVDs may contain scenes not suitable for children. Therefore, discs may contain Parental Control information that applies to the complete disc or to certain scenes on the disc. These scenes are rated from 1 to 8, and alternatively, more suitable scenes are available for selection on some discs. Ratings are country-dependent. The Parental Control feature allows you to prevent discs from being played by your children or to have certain discs played with alternative scenes.

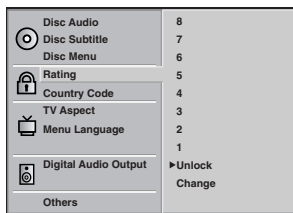

- 1** Select "Rating" on the Setup menu using the ▲ and ▼ buttons.
- 2** While "Rating" is selected, press ►.
- 3** When you have not entered a password yet. Enter a 4-digit password using the numbered buttons to create a personal 4-digit security password, then press **OK**. Enter the 4-digit password again and press **OK** to verify.
When you have already entered a password; Enter a 4-digit password using the numbered buttons to confirm the personal 4-digit security password, then press **OK**.
If you make a mistake before pressing **OK**, press **CLEAR** and enter 4-digit security password again.
- 4** Select a rating from 1 to 8 using the ▲/▼ buttons. **One (1) has the least playback restrictions. Eight (8) has the most playback restrictions.**
Unlock: If you select **Unlock**, Parental Control is not active. The disc will play in full.
Ratings 1 to 8: Some discs contain scenes not suitable for children. If you set a rating for the player, all disc scenes with the same rating or lower will be played. Higher rated scenes will not be played unless an alternative scene is available on the disc. The alternative must have the same rating or a lower one. If no suitable alternative is found, playback will stop. You must enter the 4-digit password or change the rating level in order to play the disc.
- 5** Press **OK** to confirm your rating selection, then press **SETUP** to exit the menu.

Country Code **DVD**

Enter the code of a country/area whose standards were used to rate the DVD video disc, referring to the list (See "Country Code List", page 30).

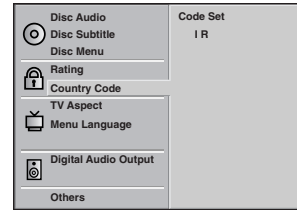

- 1** Select Country Code using the ▲/▼ buttons on the setup menu.
- 2** While Country Code is selected, press ►.
- 3** Follow step 3 of "Rating" on left.
- 4** Select the first character using the ▲/▼ buttons.
- 5** Shift the cursor using ◀▶ buttons and select the second character using ▲/▼ buttons.
- 6** Press **OK** to confirm your country code selection, then press **SETUP** to exit the menu.

Note

Confirmation of the 4-digit password is necessary when the code is changed (See "Changing the 4-digit code" below).

Changing the 4-digit code

- Follow Steps 1-2 as shown above to the left (Rating).
- Enter the old code, then press **OK**.
- Select **Change** using the ▲/▼ buttons then press **OK**.
- Enter the new 4-digit code, then press **OK**.
- Enter exactly the same code a second time and verify by pressing **OK**.
- Press **SETUP** to exit the menu.

If you forget your 4-digit code

If you forget your password, to clear the current password, follow the procedure below.

- Press **SETUP** to display the setup menu.
- Use the Number buttons to enter the 6-digit number "210499".
The 4-digit password is cleared.
- Enter a new code as shown above to the left (Rating).

Operation with tape

Playing a tape

You will only be able to load and eject video cassettes when your VCP is plugged into the mains. Your VCP may also playback recordings from NTSC tapes (on PAL TV).

Getting a better picture

When a cassette is inserted and playback started, the automatic tracking function works to get the best possible picture automatically. If the quality of the recording is poor, repeatedly press ▲ or ▼ on the remote control to manually adjust the tracking until any distortions have been removed. Press numbered 0 on the remote control to switch automatic tracking back on again.

- 1 Make sure that you have correctly connected your VCP as described earlier in this book. Turn on your TV. Press $\psi/1$ to turn on your VCP. Insert the video cassette into your VCP. The video cassette should have the window side facing up and the arrow facing away from you.

- 2 Press **PLAY** ► to start playing your tape. If you load a video cassette which has had its record protection tab removed, playback of the cassette will start automatically.

AUTO TRACKING

Your VCP will automatically adjust the tracking to give the best picture quality.

- 3 Press **II** to still a picture. Press **II** repeatedly to advance the tape frame by frame.

If you hold down **►►I**, the picture will be slowed down at about 1/19 times the normal playback. Tapes can be paused for up to 5 minutes. After 5 minutes your VCP will stop the tape to prevent damaging the tape or your VCP. Still picture quality can be improved slightly by pressing ▲ or ▼.

- 4 Press **PLAY** ► to continue playing your tape.
Picture search: During playing back press either **►►I** or **I◄◄** to this will enable you to rapidly wind the tape (7 times normal playback) see where you are on the tape.

Logic search:

During fast forwarding or rewinding press and hold **►►I** or **I◄◄** the picture will be played back at 7 times normal playback speed.

- 5 Press **■** to end playback. Press **▲**. If the end of the tape is reached, your VCP will stop playback automatically, rewind, stop, eject the tape.

CM (Commercial Message) Skip

This feature enables you during playback of a tape to skip a commercial break in a few seconds, then resume normal playback.

While tape is playing press \odot on the remote control to skip commercial (or another programme material).

Repeatedly press \odot to skip :

- 1 press : 30 seconds
- 2 press : 60 seconds
- 3 press : 90 seconds
- 4 press : 120 seconds
- 5 press : 150 seconds
- 6 press : 180 seconds

OPR (Optimum Picture Response)

This feature automatically improves playback picture quality by adjusting your VCP to the condition of the tape.

Please note you may only set OPR when playing a tape.

- 1 Press **MENU**.
- 2 Press **◀** or **▶** to select OPR.
- 3 Press **OK**.

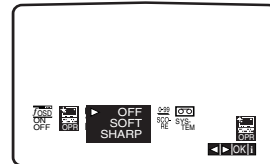

- 4 Press **◀** or **▶** repeatedly to select: **OFF**, **SOFT** or **SHARP**.
- 5 Press **OK**.
- 6 Press **MENU** to remove the menus.

Playing a DVD and Video CD

Playback Setup **DVD** **VCD2.0** **VCD1.1**

- Turn on the TV and select the video input source connected to the DVD player.
- Audio system: Turn on the audio system and select the input source connected to the DVD player.

1 Press **▲** to open the disc tray.

2 Load your chosen disc in the tray, with the label facing up.

When a double-sided DVD is inserted, make sure the side you want to play is facing up.

3 Press **▲** to close the tray.

READING appears on the TV screen, and playback starts automatically. If playback does not start, press **PLAY** **▶**.

In some cases, the disc menu might appear instead.

If a menu screen is displayed

The menu screen may be displayed first after loading a DVD or Video CD which contains a menu.

DVD

Use the **◀ ▶ ▲ ▼** buttons to select the title/chapter you want to view, then press **OK** to start playback. Press **TITLE** or **TOP MENU** to return to the menu screen.

VCD2.0

- Use the number buttons to select the track you want to view.
Press **RETURN** to return to the menu screen.
- Menu setting and the exact operating procedures for using the menu may differ depending on the disc. Follow the instructions on the each menu screen. You also may set PBC to Off under setup. See page 16.

Notes

- If Parental Control is set and the disc is not within the Rating settings (not authorized), the 4-digit code must be entered and/or the disc must be authorized (see “Parental Control”, on page 17).
- DVDs may have a region code.
- Your player will not play discs that have a region code different from your player. The region code for this player is 2 (two).
- If you load a video cassette which has had its record protection tab removed during playing the DVD, the mode will be switched to VCP automatically.

General Features

Note

Unless stated otherwise, all operations described use the remote control. Some features may also be available on the Setup menu.

Moving to another TITLE **DVD**



When a disc has more than one title, you can move to another title as follows:

- Press **DISPLAY** when playback is stopped, then press the appropriate numbered button (0-9) to select a title number.

Moving to another CHAPTER/TRACK



When a title on a disc has more than one chapter or a disc has more than one track, you can move to another chapter/track as follows:

- Press **◀◀** or **▶▶** briefly during playback to select the next chapter/track or to return to the beginning of the current chapter/track.
- Press **◀◀** twice briefly to step back to the previous chapter/track.
- To go directly to any chapter during DVD playback, press **DISPLAY**. Then, press **▲▼** to select C (chapter) (or for a Video CD, select T for track). Then, enter the chapter/track number using the numbered buttons (0-9).

Note

For two-digit numbers, press the buttons in rapid succession.

Slow Motion **DVD** **VCD2.0** **VCD1.1**

- 1 Press **◀◀** or **▶▶** during pause.
The player will enter SLOW mode.
- 2 Use the **◀◀** or **▶▶** to select the required speed:
◀◀ 1/16, **◀** 1/8, **◀◀** 1/4 or **◀◀** 1/2 (backward), or **▶▶** 1/16, **▶▶** 1/8, **▶▶** 1/4 or **▶▶** 1/2 (forward).
- 3 To exit slow motion mode, press **PLAY** **▶**.

Note

Slow motion playback in reverse is not applicable for Video CD.

General Features (continued)

Still Picture and Frame-by-frame playback

DVD VCD2.0 VCD1.1

- 1 Press **II** during playback.
The player will now go into PAUSE mode.
- 2 You can advance the picture frame-by-frame by pressing **II** repeatedly on the remote control.

Search **DVD VCD2.0 VCD1.1**

- 1 Press and hold **◀◀** or **▶▶** for about two seconds during playback.
The player will now go into SEARCH mode.
- 2 Press and hold **◀◀** or **▶▶** repeatedly to select the required speed: **◀◀X2**, **◀◀X4**, **◀◀X16**, **◀◀X100** (backward) or **▶▶X2**, **▶▶X4**, **▶▶X16**, **▶▶X100** (forward).
With a Video CD, the Search speed changes: **◀◀X2**, **◀◀X4**, **◀◀X8** (backward) or **▶▶X2**, **▶▶X4**, **▶▶X8** (forward).
- 3 To exit SEARCH mode, press **▶**.

Random **Karaoke DVD VCD1.1**

- 1 Press **RANDOM** during playback or in stop mode.
The unit automatically begins Random Playback and "RANDOM" appears on the TV screen.
- 2 To return to normal playback, press **RANDOM** again until "NORMAL" appears on the TV screen.

Tips

By pressing **◀◀** or **▶▶** during Random playback, the unit selects another title (track) and resumes Random playback.

Note

This function only works with DVD Karaoke discs and video CD without PBC.

Repeat **DVD VCD2.0 VCD1.1**



DVD Video Discs - Repeat Chapter/Title/Off

- 1 To repeat the currently playing chapter, press **REPEAT**.
The Repeat Chapter icon appears on the TV screen.
- 2 To repeat the title currently playing, press **REPEAT** a second time.
The Repeat Title icon appears on the TV screen.
- 3 To exit Repeat mode, press **REPEAT** a third time.
The Repeat Off icon appears on the TV screen.

Video CDs - Repeat Track/All/Off

- 1 To repeat the track currently playing, press **REPEAT**.
The Repeat Track icon appears on the TV screen.
- 2 To repeat the disc currently playing, press **REPEAT** a second time.
The Repeat All icon appears on the TV screen.
- 3 To exit Repeat mode, press **REPEAT** a third time.
The Repeat Off icon appears on the TV screen.

Note

On a Video CD with PBC, you must set PBC to Off on the setup menu to use the Repeat function. See page 16.

Repeat A-B **DVD VCD2.0 VCD1.1**



To repeat a sequence in a title:

- 1 Press **REPEAT A-B** at your chosen starting point.
A- appears briefly on the TV screen.
- 2 Press **REPEAT A-B** again at your chosen end point.
A-B appears briefly on the TV screen, and the repeat sequence begins (a-b repeat appears on the player's display).
- 3 To cancel the sequence, press **REPEAT A-B**.

Time Search **DVD**



The Time Search function allows you to start playing at any chosen time on the disc.

- 1 Press **DISPLAY** during playback. The on-screen display appears on the screen.
The Time Search box shows the elapsed playing time of the current disc.
- 2 Within 10 seconds, press **▲/▼** to select the Time Search icon in the on-screen display.
The ":-:--:" appears in the Time Search box.
- 3 Within 10 seconds, use the number buttons to enter the required start time. Enter hours, minutes, and seconds from left to right in the box.
If you enter the wrong numbers, press **CLEAR** to remove the numbers you entered. Then enter the correct numbers.
- 4 Within 10 seconds, press **OK** to confirm the start time.
Playback starts from the selected time on the disc. If you enter an invalid time, playback will continue from the current point.

3D Surround **DVD VCD2.0 VCD1.1**



This unit can produce a 3D Surround effect, which simulates multi-channel audio playback from two conventional stereo speakers, instead of the five or more speakers normally required to listen to multi-channel audio from a home theater system.

- 1 Press **DISPLAY** during playback.
- 2 Press **▲/▼** to select "NORM." or "3D SUR".
- 3 Press **◀▶** repeatedly until the desired sound is selected.

General Features (continued)

Zoom

The Zoom function allows you to enlarge the video image and to move through the enlarged image.

- 1 Press **ZOOM** during playback or still playback to activate the Zoom function.
If you press **ZOOM** repeatedly, the magnification level increases up to six times.
- 2 Use the ◀▶ ▲ ▼ buttons to move through the zoomed picture.
- 3 Press **CLEAR** to resume normal playback or return to the paused image.

Notes

- The zoom function may not work for some DVDs.
- The zoom function may not work on multi-angle scenes.

Marker Search



You can start playback from a memorized point. Up to nine points can be memorized.

To enter a mark, follow these steps.

- 1 During disc playback, press **MARKER** when playback reaches the spot that you want to memorize.
The Marker icon will appear on the TV screen briefly.
- 2 Repeat step 1 to enter up to nine Marker points on a disc.

To Recall a Marked Scene

- 1 During disc playback, press **SEARCH**.
The MARKER SEARCH menu will appear on the screen.
- 2 Within 10 seconds, press ◀▶ to select a Marker number that you want to recall.
- 3 Press **OK**.
Playback will start from the Marked scene.
- 4 To remove the MARKER SEARCH menu, press **SEARCH**.

To clear a Marked Scene

- 1 During disc playback, press **SEARCH**.
The MARKER SEARCH menu will appear on the screen.
- 2 Press ◀▶ to select the Marker number that you want to erase.
- 3 Press **CLEAR**.
The Marker number will be erased from the list.
- 4 Repeat steps 2 and 3 to erase additional Marker numbers.
- 5 To remove the MARKER SEARCH menu, press **SEARCH**.

Special DVD Features

Checking the contents of DVD Video discs: Menus

DVDs may contain menus that allow you to access special features. To use the disc menu, press **TOP MENU**. Then, press the appropriate number button to select an option. Or, use the ◀▶/▲/▼ buttons to highlight your selection, then press **OK**.

Title Menu

- 1 Press **TITLE**.
If the current title has a menu, the menu will appear on the screen. Otherwise, the disc menu may appear.
- 2 The menu can list camera angles, spoken language and subtitle options, and chapters for the title.
- 3 To remove the title menu, press **TITLE** again.

Disc Menu

- 1 Press **TOP MENU**.
The disc menu is displayed.
- 2 To remove the disc menu, press **TOP MENU** again.

Camera Angle

If the disc contains scenes recorded at different camera angles, you can change to a different camera angle during playback.

- Press **ANGLE** repeatedly during playback to select a desired angle.
The number of the current angle appears on the display.

Changing the Audio Language



Press **A. MONITOR** repeatedly during playback to hear a different audio language or audio track.

Subtitles

Press **SUBTITLE** repeatedly during playback to see the different subtitle languages.

Note

If  appears, the feature is not available on the disc.

Operation with Audio CD and MP3 Discs

Playing an Audio CD and MP3 discs

The DVD Player can play MP3 formatted recordings on CD-ROM, CD-R, or CD-RW discs.

Before playing MP3 recordings, read the notes on MP3 Recordings on page 25.

- 1 Insert a disc and close the tray.**
The menu appears on the TV screen.

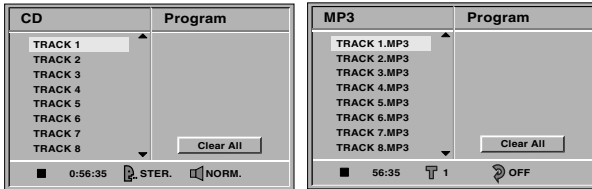

Audio CD menu

MP3 menu

- 2 Press ▲/▼ to select a track then press PLAY ►.**
Playback starts.
During playback, the current track's elapsed playing time will appear on the display.
Playback will stop at the end of the disc.

- 3 To stop playback at any other time, press ■.**

Pause **CD** **MP3**

- 1 Press **II** during playback.
- 2 To return to playback, press **PLAY ►** or press **II** again.

Moving to another Track **CD** **MP3**

- Press **I◀◀** or **▶▶I** briefly during playback to go to the next track or to return to the beginning of the current track.
- Press **I◀◀** twice briefly to step back to the previous track.
- In case of audio CD, to go directly to any track, enter the track number using the numbered buttons (0-9) during playback.

Repeat Track/All/Off **CD** **MP3**

- 1 To repeat the track currently playing, press **REPEAT**.
The Repeat Track icon appears on the menu screen.
- 2 To repeat all tracks on a disc, press **REPEAT** a second time.
The Repeat ALL icon appears on the menu screen.
- 3 To cancel Repeat mode, press **REPEAT** a third time.
The Repeat OFF icon appears on the menu screen.

Search **CD**

- 1 Press and hold **I◀◀** or **▶▶I** for about two seconds during playback.
The player will now go into SEARCH mode.
- 2 Press and hold **I◀◀** or **▶▶I** repeatedly to select the required speed: **◀◀X2**, **◀◀X4**, **◀◀X8** (backward) or **▶▶X2**, **▶▶X4**, **▶▶X8** (forward).
- 3 Search speed and direction are indicated on the menu screen.
- 4 To exit SEARCH mode, press **PLAY ►**.

Random **CD**

- 1 Press **RANDOM** during playback or when playback is stopped.
The unit automatically begins Random Playback and "RAND." appears on the menu screen.
- 2 To return to normal playback, press **RANDOM** repeatedly until "RAND." disappears on the menu screen.

Repeat A-B **CD**

To repeat a sequence.

- 1 During disc playback, press **REPEAT A-B** at your chosen starting point.
The Repeat icon and "A -" appears on the menu screen.
- 2 Press **REPEAT A-B** again at your chosen end point.
The Repeat icon and "A B" appears on the menu screen, and the sequence begins to play repeatedly.
- 3 To exit the sequence and return to normal play, press **REPEAT A-B** again.
The Repeat icon and "OFF" appear on the menu screen.

3D Surround **CD**

This unit can produce a 3D Surround effect, which simulates multi-channel audio playback from two conventional stereo speakers, instead of the five or more speakers normally required to listen to multi-channel audio from a home theater system.

- 1 Press **DISPLAY** or **A. MONITOR** during playback.
- 2 Press **◀▶** to select "NORM." or "3D SUR".
- 3 Press **▲/▼** repeatedly until the desired sound is selected.

Changing the Audio Channel **CD**

Press **A. MONITOR** repeatedly during playback to hear a different audio channel (STEREO, LEFT, or RIGHT).

Programmed Playback with Audio CD and MP3 Discs

Program allows you to store your favorite tracks for a particular disc in the player memory.

Program can contain 32 tracks (Audio CD) or 60 tracks (MP3 disc).

1 Insert the disc and close the tray.

The menu is displayed on the TV screen.

2 Press PROG. during playback or in the stop mode to enter the Program Edit mode.

The  mark will appear to the right of the word Program on the right side of the menu screen.

Note

Press **PROG.** to exit the Program Edit mode; the  mark will disappear.

3 Press ▲/▼ to select a track, then press OK to place the selected track on the Program list.

4 Repeat step 3 to place additional tracks on the Program list.

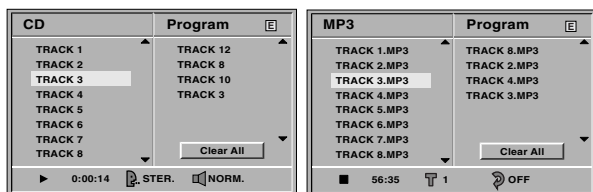

Audio CD menu

MP3 menu

5 Press ►.

The programmed track you selected last is highlighted on the program list.

6 Press ▲/▼ to select the track you want to start playing.

Press **TITLE** to move to the next page.

Press **TOP MENU** to move to the previous page.

7 Press PLAY ► to start.

Playback begins in the order in which you programmed the tracks and "PROG." appears on the display window. Playback stops after all of the tracks on the Program list have played once.

Programmed Playback with Video CD

Note

On a Video CD with PBC, you must set PBC to Off on the setup menu to use the Program function. See page 16.

1 Insert Video CD and close the tray.

2 Press PROG. while playback is stopped.

The VCD Program menu will appear.

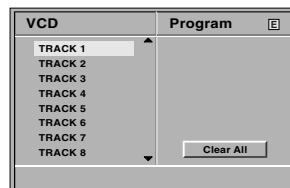

Note

Press **RETURN** or **PROG.** to exit the Program menu.

3 Follow steps 3-7 of "Programmed Playback with Audio CD and MP3 Disc" on left.

Repeat Programmed Tracks

- To repeat the track currently playing, press **REPEAT**. The Repeat Track icon appears on the menu screen.
- To repeat all tracks on the program list, press **REPEAT** a second time. The Repeat All icon appears on the menu screen.
- To cancel Repeat mode, press **REPEAT** a third time. The Repeat Off icon appears on the menu screen.

Erasing a Track from Program List

1 Press PROG. during playback or in the stop mode to enter the Program Edit mode.

The  mark will appear.

2 Press ► to move to the Program list.

3 Use ▲/▼ to select the track that you wish to erase from the Program list.

4 Press CLEAR.

The track will be erased from the Program list.

Erasing the Complete Program List

1 Follow steps 1-2 of "Erasing a Track from Program List" as above.

2 Use ▲/▼ to select "Clear All", then press OK.

The complete Program for the disc will be erased.

The programs are also cleared when the disc is removed.

To resume normal playback from programmed playback

Press and hold **PROG.** for 3 seconds until "PROG." indicator disappears in the display window.

Additional Operation - VCP part

On Screen Display

You may easily display the operating mode, tape speed, colour system, audio output channel and tape counter of your VCP on the TV screen. If a recording is taking place these On Screen Displays will not be recorded onto the tape.

Be sure to set OSD to ON.

1 Press **DISPLAY** to display.
The tape counter does not appear if there is no tape loaded.

2 After 3 seconds the majority of the On Screen Displays will clear leaving only the tape counter on the screen.
Press **DISPLAY** again to remove all displays from the TV screen.

Tape Counter Memory Stop

The **Digital Tape Counter** is displayed on the display window if there is a tape loaded. The Digital Tape Counter indicates the relative positions of recordings on the tape.

Be sure to set OSD to ON.

The counter is automatically reset to 0:00:00 and "M" appears on the TV screen.

1 Press **DISPLAY**.
Press **CLEAR** to set the counter to 0:00:00.
Press **PLAY** ► or start recording.
The tape counter will display the actual play time in hours, minutes and seconds.

2 Press ■ when playback or recording is complete.
Press ◀◀.
The tape will rewind and automatically stop when the counter returns to 0:00:00.

Video Doctor (Self-Diagnosis)

This feature informs you that there is a problem with your VCP. These error messages will appear on the TV screen.

1 Press **MENU**.
Press ◀ or ▶ to select **DR**.
Press **OK**.

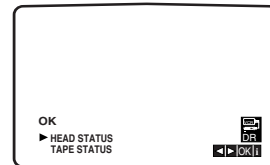

2 Press ◀ or ▶ to check a problem.
HEAD STATUS
● **OK**
● **PLEASE CLEAN:**
Clean your video heads.

TAPE STATUS

- **RECORDABLE**
- **NOT RECORDABLE:**
Insert a tape with its protection tab in place.

3 Press **OK**.

4 Press **MENU** to remove menus from the TV screen.

Hi-Fi Stereo Sound System

Press **A. MONITOR** repeatedly until the desired audio mode appears.

The choice is **HI-FI (STEREO)**, **LEFT**, **RIGHT** and **MONO**.

Last Condition Memory

DVD **CD** **VCD1.1**

This player memorizes the last condition for the last disc you have watched. Settings remain in memory even if you remove the disc from the player or switch off the player. If you load a disc that has its settings memorized, the latest stop position is automatically recalled.

Notes

- Settings are stored in memory for use any time.
- This player does not memorize settings of a disc if you switch off the player before commencing to play it.

Screen Saver

The screen saver picture appears when you leave the DVD Player in stop mode for about five minutes.

Video Mode Setting **DVD** **VCD2.0** **VCD1.1**

- With certain discs, the playback picture may be flickering or Dot Crawl is shown on straight lines. That means Vertical interpolation or De-interlace is not perfectly matched with the disc. In this case, the picture quality may be improved by changing the video mode.
- To change the video mode, press and hold **DISPLAY** about 3 seconds during disc playback. The new video mode number selected is displayed on the TV screen. Check whether the video quality has improved. If not, repeat the above procedure until picture quality is improved.
- Video mode change sequence:
MODE1 → MODE2 → MODE3 → MODE4 → MODE5 → MODE1
- If you turn off the the power, the video mode will be back to initial state (MODE1).

Notes on MP3 Discs

About MP3

- An MP3 file is audio data compressed by using MPEG1, the audio layer-3 file-coding scheme. We call files that have the “.mp3” file extension “MP3 files”.
- The player can not read an MP3 file that has a file extension other than “.mp3”.
- The player can not read a fake MP3 file that has a file extension “.mp3”.

MP3 Disc compatibility with this player is limited as follows:

1. Sampling Frequency / only at 44.1kHz
2. Bit rate/ within 32 - 320kbps
3. CD-R physical format should be “ISO 9660”
4. If you record MP3 files using the software which cannot create a FILE SYSTEM, for example “Direct-CD” etc., it is impossible to playback MP3 files. We therefore recommend that you use “Easy-CD Creator”, which creates an ISO9660 file system.
5. A single session disc requires MP3 files in the first track. If there is no MP3 file in the 1st track, it cannot playback MP3 files. If you wish to playback MP3 files, format all the data in the disc or use a new one.
6. We do not recommend using CD-RW discs. Please use finished CD-R discs only.
7. File names should be named using 8 letters or less and must incorporate the “.mp3” extension e.g. “*****.MP3”.
8. Do not use special characters such as “_?!><+*}{[@] ; ; V . , ” etc.
9. Total number of files on the disc should be less than 200.
10. Use 74 minute CD-R discs (650M), do not use 80 minute CD-R (700M) software.

This DVD player requires discs/recordings to meet certain technical standards in order to achieve optimal playback quality. Pre-recorded DVDs are automatically set to these standards. There are many different types of recordable disc formats (including CD-R containing MP3 files).

Customers should also note that permission is required in order to download MP3 files and music from the Internet. Our company has no right to grant such permission. Permission should always be sought from the copyright owner.

Special Operation - Karaoke function

Before you start karaoke

Note

You cannot enjoy Karaoke from DVD exclusive out.

You can sing along with a karaoke source (video tape, VCD, audio CD, Karaoke DVD). You can sing duets if you use an extra microphone.

1 Turn on your TV and set it to the AV. When using an amplifier, turn on the amplifier and select this player position.

2 Connect a microphone to the MIC 1 jack. To sing duets, connect another microphone to MIC 2 jack.

Karaoke sing-along

Singing along with karaoke video tapes

1 Insert a karaoke video tape. The player turns on and starts playing automatically if you insert a tape with its safety tab removed.

2 Press **PLAY ▶**. If you want to play back a specific song, perform the Karaoke search.

- Karaoke search will be operated only when a microphone has been plugged in.

Karaoke search

Press ◀ or ▶ on the remote control.

Press ◀ or ▶ again to play a desired song.

3 Now you can enjoy playing karaoke.

Singing along with karaoke VIDEO CD or DVD

1 Press ▲, and place the disc on the disc tray.

2 Press **PLAY ▶**. The disc tray closes and starts.

3 Now you can enjoy playing karaoke.

To adjust the microphone volume

Press **MIC/ECHO** to select the MIC control mode.

Press ▲/▼ for the microphone connected to MIC 1/2. Setting the microphone volume to the centre position provides the best microphone volume.

“MIC : _ _ _” appears on the TV screen.

To control the echo effect

Press **MIC/ECHO** to select the ECHO control mode.

Press ▲/▼. This controls both microphones' echo effect in the same way.

To get the best effect, adjust the microphone volume to a level slightly higher than the music volume.

“ECHO : _ _ _” appears on the TV screen.

Note

The microphone volume and the echo effect will be reset to the default setting once you disconnect the AC power cord.

Grading your singing

As an extra challenge, this player can grade your singing.

When you have finished singing, your score appears on the TV screen.

Notes

- The unit cannot grade your singing if there is no blank portion between the tracks.
- If the sound is reproduced through a stereo amplifier, turn down the volume of amplifier before operation.
- If streaks appear during playback, select the colour system that the tape was recorded in (see “To set the colour system” on page 13).
- If feedback occurs, turn down the microphone or TV volume, or move the microphone away from the speakers.

Copying from DVD to VCP

This unit allows you to copy the contents of a DVD to a VHS tape with a press of the ● button.

Note

If the DVD you are attempting to copy is copy protected, you may not be able to copy the disc.

1 Insert Disc

Insert the disc you wish to copy in the DVD deck and close the disc tray.

2 Insert VHS Tape

Insert a blank VHS video tape into the VCP deck.

3 Press DVD so that the DVD indicator lights up.

4 Copy the DVD to VHS tape

Press ●.

- The DVD will go into Play mode and the VCP will go into Record mode.
- If the DVD disc menu appears, you may need to press **PLAY ►** manually to begin copying.
- If you try to record the copy protected programme, "COPY PROTECTED DISC" appears on the TV screen and "LOCK" appears on the display window.
- Press **II** to still a picture.

5 Stop the Copy Process

Press ■.

Recording from another video player

With this video player you can make recordings from an external source, such as copying from another video player or a camcorder.

Note

In the following description, this video player will be one used for recording and will be referred to as VCP B. The other appliance will be used for playback and will be referred to as VCP A.

1 VCP A should be connected to the AUDIO L/R (VHS IN)/VIDEO (VHS IN) jack on the rear panel of your VCP.

2 Insert the recorded tape into VCP A and a blank tape into VCP B.

3 To start recording, press ● on VCP B and **PLAY ►** on VCP A.

4 When you want to finish copying, press **STOP** on both video players.

Troubleshooting

Check the following guide for the possible cause of a problem before contacting service.

Symptom	Cause	Correction
DVD or VCP do not work properly.	<ul style="list-style-type: none"> DVD or VCP button is not switched properly. 	<ul style="list-style-type: none"> Press DVD or VCP on the remote control, or DVD/VCP on the front panel to switch the control.
No power.	<ul style="list-style-type: none"> The power cord is disconnected. 	<ul style="list-style-type: none"> Plug the power cord into the wall outlet securely.
The power is on, but the DVD player does not work.	<ul style="list-style-type: none"> No disc is inserted. 	<ul style="list-style-type: none"> Insert a disc. (Check that the DVD or, audio CD indicator in the display window is lit.)
No picture.	<ul style="list-style-type: none"> The TV is not set to receive DVD signal output. 	<ul style="list-style-type: none"> Select the appropriate video input mode on the TV so the picture from the DVD player appears on the TV screen.
No sound.	<ul style="list-style-type: none"> The equipment connected with the audio cable is not set to receive DVD signal output. 	<ul style="list-style-type: none"> Select the correct input mode of the audio receiver so you can listen to the sound from the DVD player.
	<ul style="list-style-type: none"> The audio cables are not connected securely. 	<ul style="list-style-type: none"> Connect the audio cable into the jacks securely.
	<ul style="list-style-type: none"> The power of the equipment connected with the audio cable is turned off. 	<ul style="list-style-type: none"> Turn on the equipment connected with the audio cable.
	<ul style="list-style-type: none"> The Digital Audio Output is set to the wrong position. 	<ul style="list-style-type: none"> Set the Digital Audio Output to the correct position, then turn on the DVD player again by pressing POWER.
The picture is poor.	<ul style="list-style-type: none"> The disc is dirty. 	<ul style="list-style-type: none"> Clean the disc.
The DVD player does not start playback.	<ul style="list-style-type: none"> An unplayable disc is inserted. 	<ul style="list-style-type: none"> Insert a playable disc. (Check the disc type, color system and Regional code.)
	<ul style="list-style-type: none"> The disc is placed upside down. 	<ul style="list-style-type: none"> Place the disc with the playback side down.
	<ul style="list-style-type: none"> The disc is not placed within the guide. 	<ul style="list-style-type: none"> Place the disc on the disc tray correctly inside the guide.
	<ul style="list-style-type: none"> The disc is dirty. 	<ul style="list-style-type: none"> Clean the disc.
	<ul style="list-style-type: none"> The Rating level is set. 	<ul style="list-style-type: none"> Cancel the Rating function or change the rating level.
The remote control does not work properly.	<ul style="list-style-type: none"> There is an obstacle in the path of the remote control and this unit. 	<ul style="list-style-type: none"> Remove the obstacle.
	<ul style="list-style-type: none"> The batteries in the remote control are exhausted. 	<ul style="list-style-type: none"> Replace the batteries with new ones.
Video tape cannot be inserted.	<ul style="list-style-type: none"> Is the cassette compartment empty? 	<ul style="list-style-type: none"> Eject the tape in.
No Hi-Fi sound	<ul style="list-style-type: none"> Audio mode is not set properly. 	<ul style="list-style-type: none"> Select "HI-FI" by repeatedly pressing A. MONITOR on the remote control.

Video Head Cleaning

Whenever a video cassette is inserted into or ejected from your VCP, the video head is automatically cleaned. This should mean that additional head cleaning should not be necessary. However dirt accumulating on the head after a long period of time can cause the playback picture to become blurred or broken up. High quality video cassette tapes will not normally deposit dirt onto the video head, but old or damaged tapes might.

Language Code List

Enter the appropriate code number for the initial settings “Disc Audio”, “Disc Subtitle” and/or “Disc Menu” (See page 15).

Code	Language	Code	Language	Code	Language	Code	Language
6565	Afar	7079	Faroese	7678	Lingala	8375	Slovak
6566	Abkhazian	7082	French	7679	Laothian	8376	Slovenian
6570	Afrikaans	7089	Frisian	7684	Lithuanian	8377	Samoaan
6577	Ameharic	7165	Irish	7686	Latvian, Lettish	8378	Shona
6582	Arabic	7168	Scots Gaelic	7771	Malagasy	8379	Somali
6583	Assamese	7176	Galician	7773	Maori	8381	Albanian
6588	Aymara	7178	Guarani	7775	Macedonian	8382	Serbian
6590	Azerbaijani	7185	Gujarati	7776	Malayalam	8385	Sudanese
6665	Bashkir	7265	Hausa	7778	Mongolian	8386	Swedish
6669	Byelorussian	7273	Hindi	7779	Moldavian	8387	Swahili
6671	Bulgarian	7282	Croatian	7782	Marathi	8465	Tamil
6672	Bihari	7285	Hungarian	7783	Malay	8469	Telugu
6678	Bengali; Bangla	7289	Armenian	7784	Maltese	8471	Tajik
6679	Tibetan	7365	Interlingua	7789	Burmese	8472	Thai
6682	Breton	7378	Indonesian	7865	Nauru	8473	Tigrinya
6765	Catalan	7383	Icelandic	7869	Nepali	8475	Turkmen
6779	Corsican	7384	Italian	7876	Dutch	8476	Tagalog
6783	Czech	7387	Hebrew	7879	Norwegian	8479	Tonga
6789	Welsh	7465	Japanese	7982	Oriya	8482	Turkish
6865	Danish	7473	Yiddish	8065	Panjabi	8484	Tatar
6869	German	7487	Javanese	8076	Polish	8487	Twi
6890	Bhutani	7565	Georgian	8083	Pashto, Pushto	8575	Ukrainian
6976	Greek	7575	Kazakh	8084	Portuguese	8582	Urdu
6978	English	7576	Greenlandic	8185	Quechua	8590	Uzbek
6979	Esperanto	7577	Cambodian	8277	Rhaeto-Romance	8673	Vietnamese
6983	Spanish	7578	Kannada	8279	Rumanian	8679	Volapük
6984	Estonian	7579	Korean	8285	Russian	8779	Wolof
6985	Basque	7583	Kashmiri	8365	Sanskrit	8872	Xhosa
7065	Persian	7585	Kurdish	8368	Sindhi	8979	Yoruba
7073	Finnish	7589	Kirghiz	8372	Serbo-Croatian	9072	Chinese
7074	Fiji	7665	Latin	8373	Singhalese	9085	Zulu

Country Code List

Enter the appropriate code number for the initial setting "Country Code" (See page 17).

Code	Country	Code	Country	Code	Country	Code	Country
AD	Andorra	ER	Eritrea	LC	Saint Lucia	SC	Seychelles
AE	United Arab Emirates	ES	Spain	LI	Liechtenstein	SD	Sudan
AF	Afghanistan	ET	Ethiopia	LK	Sri Lanka	SE	Sweden
AG	Antigua and Barbuda	FI	Finland	LR	Liberia	SG	Singapore
AI	Anguilla	FJ	Fiji	LS	Lesotho	SH	Saint Helena
AL	Albania	FK	Falkland Islands	LT	Lithuania	SI	Slovenia
AM	Armenia	FM	Micronesia	LU	Luxembourg	SJ	Svalbard and Jan Mayen Islands
AN	Netherlands Antilles	FO	Faroe Islands	LV	Latvia	SK	Slovak Republic
AO	Angola	FR	France	LY	Libya	SL	Sierra Leone
AQ	Antarctica	FX	France (European Territory)	MA	Morocco	SM	San Marino
AR	Argentina	GA	Gabon	MC	Monaco	SN	Senegal
AS	American Samoa	GB	Great Britain	MD	Moldavia	SO	Somalia
AT	Austria	GD	Grenada	MG	Madagascar	SR	Suriname
AU	Australia	GE	Georgia	MH	Marshall Islands	ST	Saint Tome and Principe
AW	Aruba	GF	French Guyana	MK	Macedonia	SU	Former USSR
AZ	Azerbaijan	GH	Ghana	ML	Mali	SV	El Salvador
BA	Bosnia-Herzegovina	GI	Gibraltar	MM	Myanmar	SY	Syria
BB	Barbados	GL	Greenland	MN	Mongolia	SZ	Swaziland
BD	Bangladesh	GM	Gambia	MO	Macau	TC	Turks and Caicos Islands
BE	Belgium	GN	Guinea	MP	Northern Mariana Islands	TD	Chad
BF	Burkina Faso	GP	Guadeloupe (French)	MQ	Martinique (French)	TF	French Southern Territories
BG	Bulgaria	GQ	Equatorial Guinea	MR	Mauritania	TG	Togo
BH	Bahrain	GR	Greece	MS	Montserrat	TH	Thailand
BI	Burundi	GS	S. Georgia & S. Sandwich Isls.	MT	Malta	TJ	Tadjikistan
BJ	Benin	GT	Guatemala	MU	Mauritius	TK	Tokelau
BM	Bermuda	GU	Guam (USA)	MV	Maldives	TM	Turkmenistan
BN	Brunei Darussalam	GW	Guinea Bissau	MW	Malawi	TN	Tunisia
BO	Bolivia	GY	Guyana	MX	Mexico	TO	Tonga
BR	Brazil	HK	Hong Kong	MY	Malaysia	TP	East Timor
BS	Bahamas	HM	Heard and McDonald Islands	MZ	Mozambique	TR	Turkey
BT	Bhutan	HN	Honduras	NA	Namibia	TT	Trinidad and Tobago
BV	Bouvet Island	HR	Croatia	NC	New Caledonia (French)	TV	Tuvalu
BW	Botswana	HT	Haiti	NE	Niger	TW	Taiwan
BY	Belarus	HU	Hungary	NF	Norfolk Island	TZ	Tanzania
BZ	Belize	ID	Indonesia	NG	Nigeria	UA	Ukraine
CA	Canada	IE	Ireland	NL	Netherlands	UG	Uganda
CC	Cocos (Keeling) Islands	IL	Israel	NO	Norway	UK	United Kingdom
CF	Central African Republic	IN	India	NP	Nepal	UM	USA Minor Outlying Islands
CG	Congo	IO	British Indian Ocean Territory	NR	Nauru	US	United States
CH	Switzerland	IQ	Iraq	NU	Niue	UY	Uruguay
CI	Ivory Coast	IR	Iran	NZ	New Zealand	UZ	Uzbekistan
CK	Cook Islands	IS	Iceland	OM	Oman	VA	Vatican City State
CL	Chile	IT	Italy	PA	Panama	VC	Saint Vincent & Grenadines
CM	Cameroon	JM	Jamaica	PE	Peru	VE	Venezuela
CN	China	JO	Jordan	PF	Polynesia (French)	VG	Virgin Islands (British)
CO	Colombia	JP	Japan	PG	Papua New Guinea	VI	Virgin Islands (USA)
CR	Costa Rica	KE	Kenya	PH	Philippines	VN	Vietnam
CS	Former Czechoslovakia	KG	Kyrgyzstan	PK	Pakistan	VU	Vanuatu
CU	Cuba	KH	Cambodia	PL	Poland	WF	Wallis and Futuna Islands
CV	Cape Verde	KI	Kiribati	PM	Saint Pierre and Miquelon	WS	Samoa
CX	Christmas Island	KM	Comoros	PN	Pitcairn Island	YE	Yemen
CY	Cyprus	KN	Saint Kitts & Nevis Anguilla	PR	Puerto Rico	YT	Mayotte
CZ	Czech Republic	KP	North Korea	PT	Portugal	YU	Yugoslavia
DE	Germany	KR	South Korea	PW	Palau	ZA	South Africa
DJ	Djibouti	KW	Kuwait	PY	Paraguay	ZM	Zambia
DK	Denmark	KY	Cayman Islands	QA	Qatar	ZR	Zaire
DM	Dominica	KZ	Kazakhstan	RE	Reunion (French)	ZW	Zimbabwe
DO	Dominican Republic	LA	Laos	RO	Romania		
DZ	Algeria	LB	Lebanon	RU	Russian Federation		
EC	Ecuador			RW	Rwanda		
EE	Estonia			SA	Saudi Arabia		
EG	Egypt			SB	Solomon Islands		
EH	Western Sahara						

Specification

General

Power requirements	AC 110-240V , 50/60 Hz
Power consumption	20W
Dimensions (approx.)	430 X 97.5 X 360 mm (w/h/d)
Mass (approx.)	5.3 kg
Operating temperature	5°C to 35°C
Operating humidity	5 % to 90 %

System

Laser	Semiconductor laser, wavelength 650 nm
Video Head system	Double azimuth 4 heads, helical scanning.
Signal system	PAL/NTSC
Frequency response	DVD (PCM 96 kHz): 2 Hz to 44 kHz DVD (PCM 48 kHz): 2 Hz to 22 kHz CD: 2 Hz to 20 kHz
Signal-to-noise ratio	More than 100dB (ANALOG OUT connectors only)
Harmonic distortion	Less than 0.008%
Dynamic range	More than 95 dB (DVD) More than 95 dB (CD)
Wow and flutter	Less than detected value ($\pm 0.001\%$ W PEAK)

Inputs (VCP)

Audio	-6.0dBm, more than 47 kohms
Video	1.0 Vp-p, 75 ohms, unbalanced

Outputs (DVD)

VIDEO OUT	1 Vp-p 75 ohms, sync negative
COMPONENT VIDEO OUT	(Y) 1.0 V (p-p), 75 Ω , negative sync., RCA jack x 1 (Pb)/(Pr) 0.7 V (p-p), 75 Ω , RCA jack x 2
Audio output (digital audio)	0.5 V (p-p), 75 Ω , RCA jack x 1
Audio output (analog audio)	2.0 Vrms (1 KHz, 0 dB), 330 Ω , RCA jack (L, R)

Outputs (VCP/DVD)

Audio	-6.0dBm, less than 1 kohms
Video	1.0 Vp-p, 75 ohms, unbalanced

Manufactured under license from Dolby Laboratories. "Dolby" and the double-D symbol are trademarks of Dolby Laboratories. Confidential unpublished works. Copyright 1992-1997 Dolby Laboratories. All rights reserved.

"DTS" and "DTS Digital Out" are trademarks of Digital Theater Systems, Inc.

- Design and specifications are subject to change without notice.

