



48ZG,ZN030-105
48ZT,ZW,Z6,Z8075-105
Gas Heating/Electric Cooling Units
with COMFORTLINK™ Controls

User's Information Manual

NOTE TO INSTALLER:

This manual should be left with the equipment owner.

WARNING: If the information in this manual is not followed exactly, a fire or explosion may result causing property damage, personal injury or loss of life.

- Do not store or use gasoline or other flammable vapors and liquids in the vicinity of this or any other appliance.
- WHAT TO DO IF YOU SMELL GAS
 - Do not try to light any appliance.
 - Do not touch any electrical switch; do not use any phone in your building.
 - Immediately call your gas supplier from a neighbor's phone. Follow the gas supplier's instructions.
 - If you cannot reach your gas supplier, call the fire department.
- Installation and service must be performed by a qualified installer, service agency or the gas supplier.

⚠ WARNING

Improper installation, adjustment, alteration, service, or maintenance can cause injury or property damage. Refer to this manual. For assistance or additional information, consult a qualified installer, service agency, or the gas supplier.

⚠ WARNING

Before performing recommended maintenance, be sure main power switch to unit is turned off. Electrical shock could cause personal injury.

Your combination heating/cooling rooftop unit is equipped with an automatic direct spark ignition system and induced-draft power combustion blower.

⚠ WARNING

Do not attempt to light by hand; personal injury may result.

TO LIGHT UNIT

⚠ DANGER

1. Do not turn off the electrical power to unit without first turning off the gas supply.
2. Before attempting to start the gas heating section, familiarize yourself with all the procedures that must be followed.
3. Never attempt to manually light the unit with a match, lighter, or any other flame. If the electric sparking device fails to light the burners, refer to the shutdown procedures, then call your dealer as soon as possible.

If you do not follow these instructions exactly, a fire or explosion may result, causing property damage, injury, or loss of life.

See Fig. 1 for location of gas valve(s). Refer to Fig. 2 while proceeding with the following steps.

1. Turn off the unit demand for cooling or heating by using the scrolling marquee. The scrolling marquee is located in the control box at the compressor end of the unit.
 - a. Push the **ESCAPE** key until a blank display screen is shown.
 - b. Push the **▼** key until the SERVICE TEST LED is lit.
 - c. Push the **ENTER** key. The display will show STOP.
 - d. Push the **ENTER** key again. The NO/YES display will flash.
 - e. Push the **▲** or **▼** key to toggle the display to YES and then push **ENTER**. The unit will be locked off from heating, cooling or any operation. The controls will still function and the display will still operate.
2. Close the field-installed manual gas shutoff valve.
3. Turn off the electrical power to the unit using the optional disconnect or the field-installed disconnect and lock off using proper lockout and tag-out procedures.
4. Open the burner section hinged access door.
5. Move the switch on the gas valves to the OFF position and wait 5 minutes.

NOTE: If this is the first installation of the unit, the gas flue hoods must be installed before operating unit. These must be installed for the unit to run properly.
6. Move the switch on the gas valves to the ON position.
7. Close the burner section hinged access door.
8. Turn on the electrical supply to the units.
9. Open the field-installed manual gas valve.

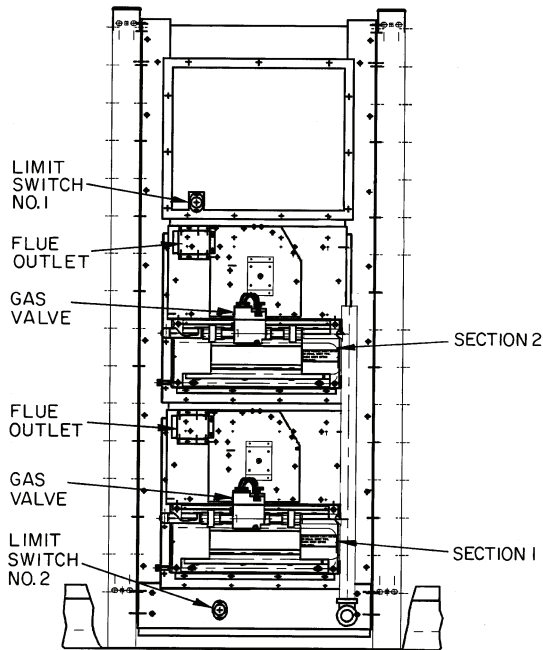

NOTE: High heat consists of sections 1 and 2. Low heat consists of section 1 only.

030-050 SIZES

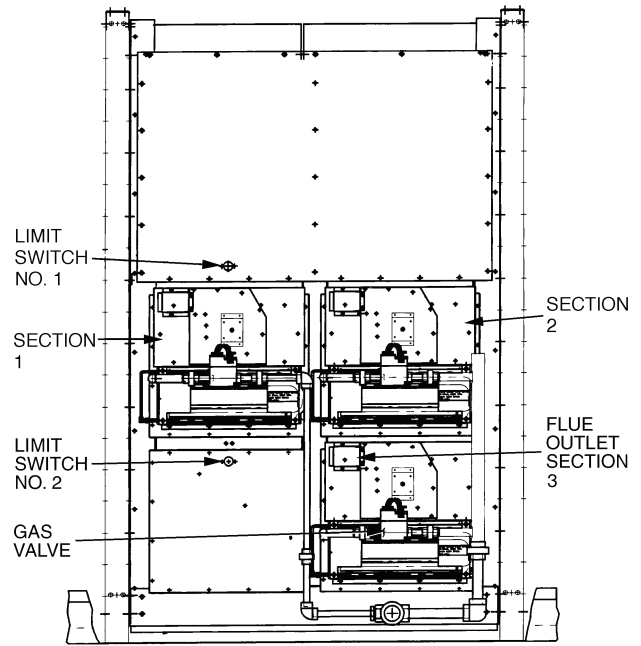

NOTE: High heat consists of sections 1-3. Low heat consists of sections 1 and 2 only.

055-105 SIZES

Fig. 1 — Heat Section Details

10. Using the scrolling marquee, enable the unit to run using the following procedure:
 - a. Push the **ESCAPE** key until a blank display screen is shown.
 - b. Push the **▼** key until the SERVICE TEST LED is lit.
 - c. Push the **ENTER** key. The display will show STOP.
 - d. Push the **ENTER** key again. The NO/YES display will flash.
 - e. Push the **▲** or **▼** key to toggle the display to NO and then push **ENTER**. The unit will return to normal operation and exit SERVICE TEST mode.

11. To test the operation of the gas section, use the scrolling marquee Service Test routine to energize the gas outputs and to turn on the gas. Refer to the unit Controls, Start-Up, Operation, Service and Troubleshooting literature for more information.
12. For normal operation, make sure that units with a conventional thermostat are set to heating control temperature. On VAV (variable air volume) and constant volume units with a space temperature sensor, make sure that the set points are at the normal heat set points.

⚠ WARNING

If the main burners fail to light, or the blower fails to come on, shut down gas heating section and call your dealer for service. Failure to follow these requirements could result in serious personal injury.

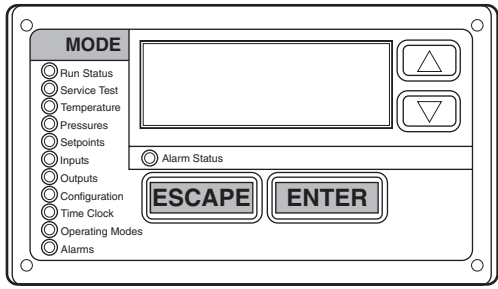

STEP 1

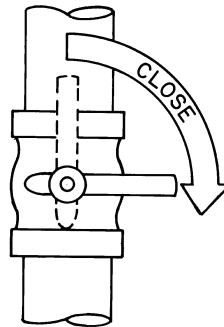

STEP 2

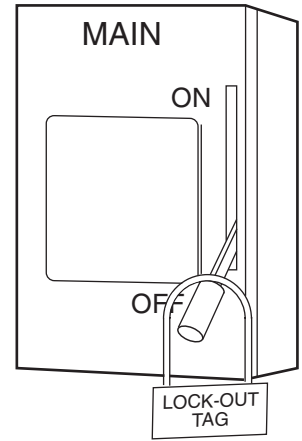

STEP 3

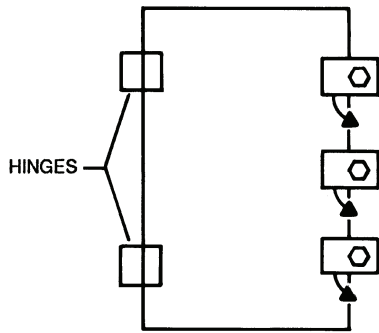

STEP 4

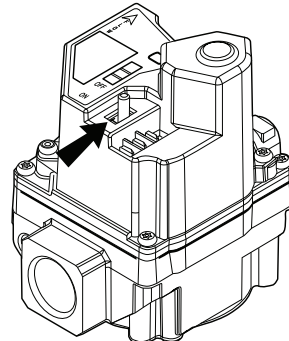

STEP 5

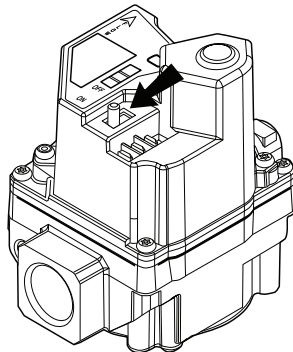

STEP 6

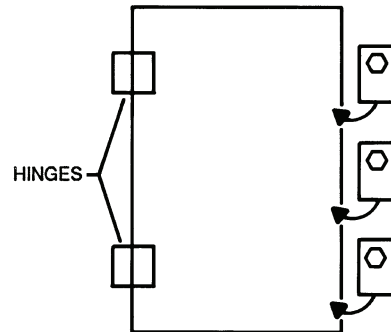

STEP 7

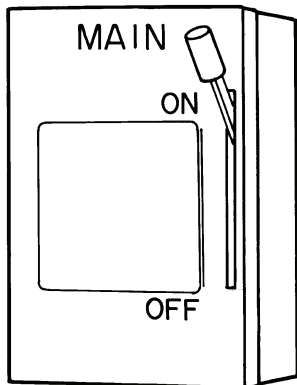

STEP 8

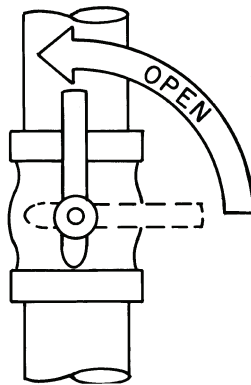

STEP 9

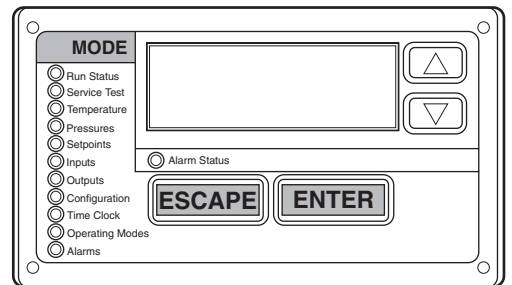

STEP 10

Fig. 2 — To Light Unit

TO SHUT UNIT OFF

⚠ WARNING

Do not turn off the electrical power to unit without first turning off the gas supply.

Never attempt to manually light the main burners on a unit with a match, lighter, or any other flame.

If the electric sparking device fails to light the main burners, refer to the following shut off procedure, then call your dealer as soon as possible.

Failure to follow these procedures can result in serious fire or personal injury.

See Fig. 1 for location of gas valve(s). Refer to Fig. 3 while proceeding with the following steps.

1. Turn off the unit demand for cooling or heating by using the scrolling marquee. The scrolling marquee is located in the control box at the compressor end of the unit.
 - a. Push the **ESCAPE** key unit a blank display screen is shown.
 - b. Push the **▼** key until the SERVICE TEST LED is lit.
 - c. Push the **ENTER** key. The display will show STOP.
 - d. Push the **ENTER** key again. The NO/YES display will flash.
 - e. Push the **▲** or **▼** key to toggle the display to YES and then push **ENTER**. The unit will be locked off from heating, cooling or any operation. The controls will still function and the display will still operate.
2. Close the field-installed manual gas shutoff valve.
3. Turn off the electrical power to the unit using the optional disconnect or the field-installed disconnect and lock off using proper lockout and tag-out procedures.
4. Open the burner section hinged access door.
5. Move the switch on the gas valves to the OFF position and wait 5 minutes before doing any service in the section or on the piping.
6. Close the burner section hinged access door.
7. If unit is being shut down because of a malfunction, call your dealer as soon as possible.
If unit is being shut down because the heating season has ended, restore electrical power to the unit and reset the scrolling marquee to Run mode to ensure operation of the cooling system during the cooling season.

IMPORTANT: Should overheating occur or the gas supply fail to shut off, shut off the manual gas valve to the unit before shutting off the electrical supply.

Do not use this unit if any part has been under water. Immediately call a qualified service technician to inspect the unit and to replace any part of the control system and gas control that has been under water.

MAINTAINING YOUR UNIT

All maintenance should be handled by skilled, experienced personnel. Your dealer can help you establish a standard procedure.

For your safety, keep the gas heating area clear and free of combustible materials, gasoline, and other flammable liquids and vapors.

To ensure proper functioning of the unit, flow of combustion and ventilating air must not be obstructed from reaching the gas heating area. Clearance of at least 4 ft on all sides is required.

ROUTINE MAINTENANCE AND CARE FOR THE EQUIPMENT OWNER

Before proceeding with those things you might want to maintain yourself, please carefully consider the following:

⚠ WARNING

1. TURN OFF GAS SUPPLY FIRST AND THEN ELECTRICAL POWER TO YOUR UNIT BEFORE SERVICING OR PERFORMING MAINTENANCE.
2. Do not turn off electrical power to this unit without first turning off the gas supply.
3. When opening access doors or performing maintenance functions inside your unit, be aware of sharp sheet metal parts and screws. Although special care has been taken to reduce sharp edges to a minimum, be extremely careful when handling parts or reaching into the unit.

Failure to follow these procedures can result in serious fire or personal injury.

Air Filters — Air filters should be checked at least every 3 or 4 weeks and changed or cleaned whenever they become dirty. Table 1 indicates the correct filter size for your unit. Open the hinged filter access door to replace or inspect the filters. All units have filter tracks into which the filters slide. Remove the filters by pulling outward from the track. See Fig. 4 for filter access door location. Note the direction of flow arrows on the filter frame.

If you have difficulty in locating your air filter in the return-air duct system, or if you have questions concerning proper filter maintenance, contact your dealer for instructions.

Table 1 — Indoor-Air Filter Data*

UNIT SIZE	FILTER TYPE	QUANTITY...Size (in.)
48Z	Disposable Fiberglass (Standard) or Medium Efficiency 30% Pleated (Optional)	8...20 x 25 x 2, 8...20 x 20 x 2
	90% Bag (Optional) with High-Velocity Pre-Filters	6...20 x 24 x 22, 6...20 x 20 x 22, 12...16 x 20 x 2, 3...20 x 24 x 2
030-050	Disposable Fiberglass (Standard) or Medium Efficiency 30% Pleated (Optional)	12...20 x 25 x 2, 12...20 x 25 x 2
	90% Bag (Optional) with High-Velocity Pre-Filters	6...24 x 20 x 22, 6...24 x 24 x 22, 6...20 x 24 x 2, 6...24 x 24 x 2
055-070	Disposable Fiberglass (Standard) or Medium Efficiency 30% Pleated (Optional)	12...20 x 25 x 2, 12...20 x 20 x 2
	High Efficiency 65% Pleated (Optional)	12...20 x 25 x 2, 12...20 x 20 x 2
075	Disposable Fiberglass (Standard) or Medium Efficiency 30% Pleated (Optional)	12...20 x 25 x 2, 12...20 x 20 x 2
	High Efficiency 65% Pleated (Optional)	12...20 x 25 x 2, 12...20 x 20 x 2
090,105	Disposable Fiberglass (Standard) or Medium Efficiency 30% Pleated (Optional)	12...20 x 25 x 2, 12...20 x 20 x 2
	High Efficiency 65% Pleated (Optional)	12...20 x 25 x 2, 12...20 x 20 x 2

*See base unit Installation Instructions if field-supplied or optional factory-supplied filters are used. When replacing filters, always use the same type and size originally supplied.

When replacing your unit filters, always use the same size and type of filter that was originally supplied by the installer.

Units with outdoor air capability have a cleanable filter for the outdoor air. This filter should be checked annually and cleaned as necessary. Remove by removing screws in outdoor-air filter retainer and sliding filters out of the unit.

⚠ WARNING

Never operate your unit without filters in place. Failure to heed this warning may result in damage to the blower motor and/or compressor. An accumulation of dust and lint on internal parts of your unit can cause loss of efficiency and, in some cases, fire.

Heat Exchanger — To ensure dependable and efficient heating operation, the heat exchanger should be checked by a qualified maintenance person before each heating season, and cleaned when necessary. This checkout should not be attempted by anyone not having the required expertise and equipment to do the job properly. Checking and/or cleaning the heat exchanger involves removing the gas controls assembly and the flue collector box cover and, when completed, reinstalling the gas controls assembly for proper operation. Also, the flue collector box cover must be replaced correctly so that a proper seal is maintained. Contact your dealer for the required periodic maintenance.

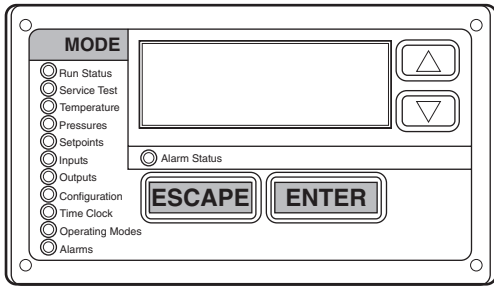

STEP 1

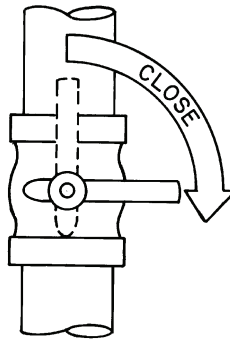

STEP 2

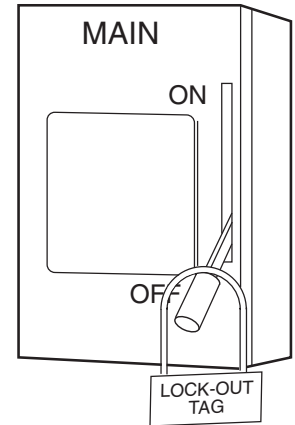

STEP 3

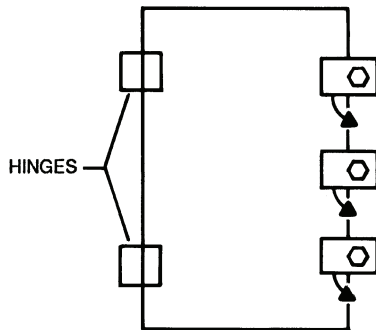

STEP 4

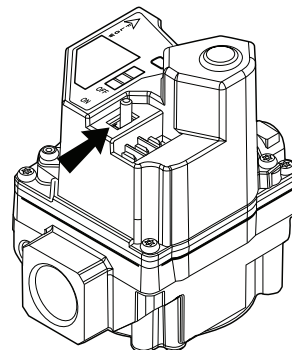

STEP 5

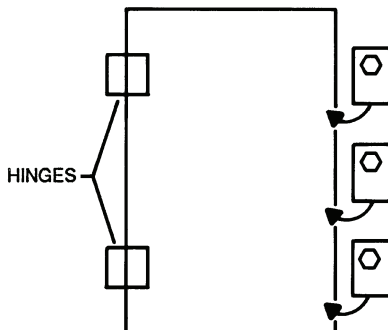

STEP 6

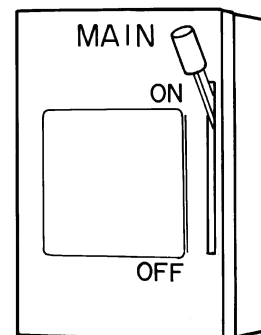

STEP 7

Fig. 3 — To Shut Unit Off

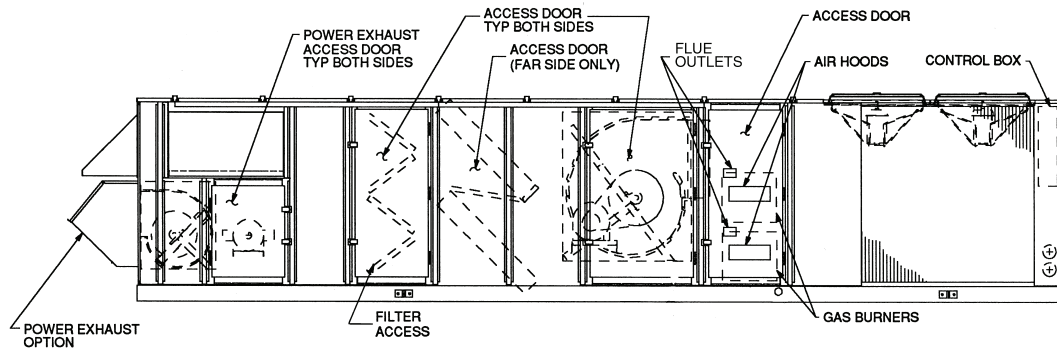

SIZES 030-050 (040 SHOWN)

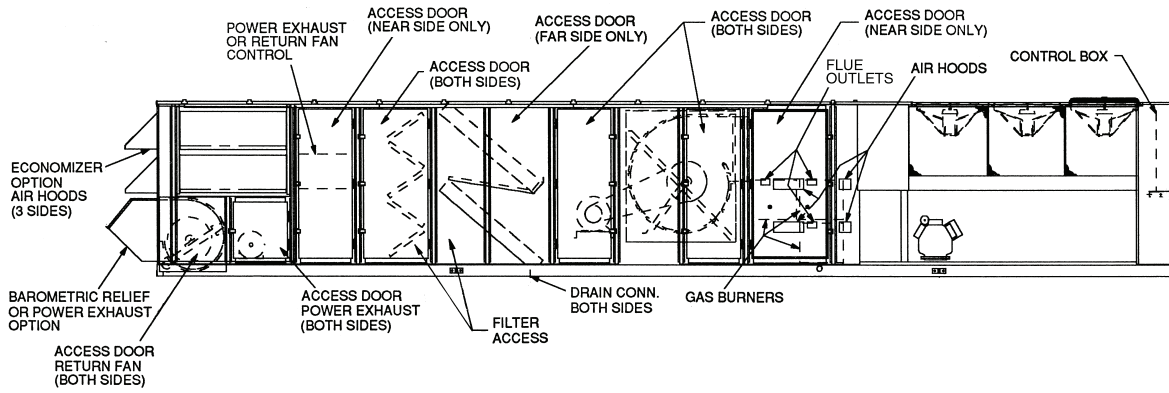

SIZES 055-070

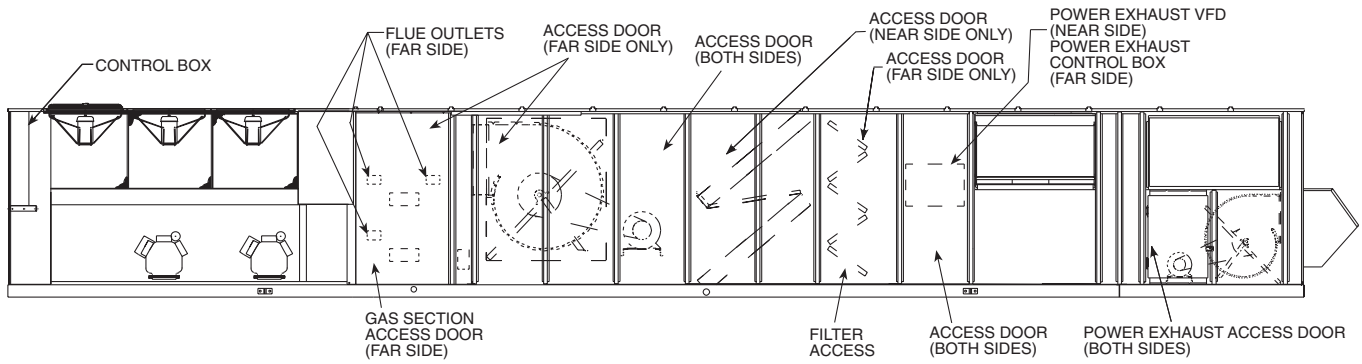

SIZES 075-105

Fig. 4 — Door Locations (48Z Series Units)

Fan and Belts — Periodically check the condition of fan wheels and housings and belt tension. When service is necessary, call your dealer.

Evaporator-Fan Motor, Condenser-Fan Motor and Combustion-Fan Motor — Lubrication is not recommended. Bearings will not require lubrication for at least 5 years of normal operation. After 5 years, motor life can be extended by having the motors serviced at an authorized motor service shop.

Fan Shaft Bearings — Charge fittings annually with Shell Alvania No. 2 or equivalent grease.

Evaporator and Condenser Coils — Cleaning of the coils should only be done by qualified service personnel. Contact your dealer for the required maintenance as needed.

Condensate Drain — The drain pan and condensate drain line should be checked and cleaned at the same time the cooling coils are checked by your dealer.

Compressors — All compressors are factory shipped with a normal charge of the correct type refrigeration grade oil in them and should rarely require additional oil. The service technician must be certain the proper oil level is maintained in the compressor when it is installed and running.

Condenser Fan

⚠ WARNING

Do not poke sticks, screwdrivers, or any other object into revolving fan blades. Severe bodily injury may result.

The fan must be kept free of all obstructions to ensure proper cooling. Contact your dealer for any required service.

Electrical Controls and Wiring — Electrical controls are difficult to check without proper instrumentation; therefore, if there are any discrepancies in the operating cycle, contact your dealer and request service.

Refrigerant Circuit — The refrigerant circuit is difficult to check for leaks without the proper equipment; therefore, if inadequate cooling is suspected, contact your dealer for service.

Combustion Area and Vent System — The combustion area and vent system should be visually inspected before each heating season. The normal accumulation of dirt, soot, rust, and scale can result in loss of efficiency and improper performance if allowed to build up. Accumulation on the burner crossover tube can result in the burners firing out of normal time sequence. This delayed ignition is characterized by an especially loud sound.

⚠ CAUTION

If your unit makes an unusual or especially loud noise when the main burners are lit, shut down the heating section and call your dealer. Bodily injury or unit damage may result.

See Fig. 1 and 5 and proceed as follows to inspect the combustion area and power-venting system of your unit.

1. Turn off gas supply and then electrical power to your unit.
2. Open gas section access door.
3. Using a flashlight, carefully inspect the burner areas for dirt, soot, rust, or scale.

⚠ CAUTION

If dirt, soot, rust, or scale accumulations are found, call your dealer and do not operate your heating section. Bodily injury or unit damage may result.

4. When you have completed your inspection, follow the start-up procedures in this manual to restore your unit to operation.
5. Observe unit heating operation, and watch the burner flame core to see if it is bright blue. If you observe a suspected malfunction, or if the burner flame cores are not bright blue, call your dealer. See Fig. 6.
NOTE: Burner flame cores that have a mixture of orange, yellow, or red flames together with the blue may not be burning gas efficiently. Your dealer may have to adjust the air/gas mixture.
6. Replace gas section access panel.

Unit Panels and Doors — After performing any maintenance or service on the unit, be sure all panels and doors are securely fastened in place to prevent rain from entering unit cabinet and to prevent disruption of the correct unit airflow pattern.

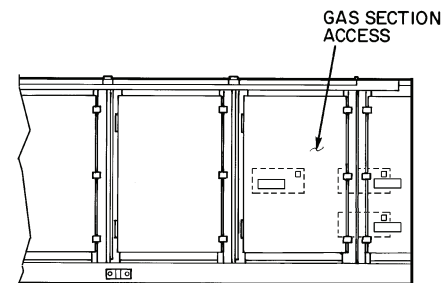

Fig. 5 — Typical Location of Access Panel

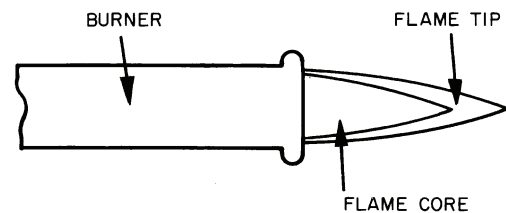

Fig. 6 — Proper Flame Appearance

REGULAR DEALER MAINTENANCE

In addition to the type of routine maintenance you might be willing to perform, your unit should be inspected regularly by a properly trained service technician. An inspection (preferably each year, but at least every other year) should include the following:

1. Inspection of all flue product passages — including the burners, heat exchanger, flue collector box, and vent pipe.
2. Inspection of all combustion-air and ventilation-air passages and openings.
3. Close inspection of all gas pipes leading to and inside your unit.
4. Adjustment of the air/gas mixture if the burner flames are not bright blue. (See Fig. 5 and 6 for location of access panel and proper flame appearance.)
5. Inspection, and if required, cleaning of the condenser and evaporator coils.
6. Inspection, and if required, cleaning of the evaporator drain pan.
7. Inspection, cleaning, and lubrication of blower wheel housing and motor.
8. Inspection of all supply-air and return-air ducts for leaks, obstructions, and insulation integrity. Any problems found should be resolved at this time.
9. Inspection of the unit base to ensure that no cracks, gaps, etc., exist which may cause a hazardous condition.
10. Inspection of the unit casing for signs of deterioration.
11. Inspection of all electrical wiring and components to assure proper connection.
12. Inspection for leaks in the refrigerant circuit. Pressure-check to determine appropriate refrigerant charge.
13. Operational check of the unit to determine working conditions. Repair or adjustment should be made at this time.
14. Your servicing dealer may offer an economical service contract that covers seasonal inspections. Ask for further details.

Complete Service Instructions can be found in the base unit Controls, Start-Up, Operation, Service and Troubleshooting literature.

BEFORE YOU CALL FOR SERVICE, CHECK FOR SEVERAL EASILY SOLVED PROBLEMS

If insufficient heat or cooling is suspected:

() Check for sufficient airflow. Check the air filters for dirt. Check for blocked return-air or supply-air grilles. Be sure they are open and unobstructed. Be sure heating and cooling set points are correct. If these checks do not reveal the cause, call your servicing dealer.

If your unit is not operating at all, check the following list for easy solutions:

() Check to be sure that heating temperature set point is set above the indoor temperature during the heating season, or that cooling temperature set point is below the indoor temperature during the cooling season. Be sure the unit on/off switch is in the ON position and not in the OFF position. Be sure unit has been programmed with the appropriate time schedules and desired operating set points.

() Is the electrical supply switch ON? Are any fuses blown, or have any of the circuit breakers tripped?

() During the heating season, check the manual shutoff valve. Is this lever parallel with the pipe, indicating that the valve is open? Or is the lever at a right angle, indicating that the valve is closed? If closed, has the gas been shut off for safety reasons? Otherwise, you may open the valve and follow the start-up procedures listed in this manual.

NOTE: Before proceeding with the next check, turn OFF the electrical power supply to the unit. Open the control access door.

() During the heating season, check the control switch on the gas valve. It is in the ON position? If it is not, be sure it has not been turned off for the purpose of safety. Follow the start-up procedures in this manual.

() If your unit still fails to operate, call your servicing dealer for troubleshooting and repairs. Specify the model and serial numbers of your unit. (Record them in this manual in the space provided.) If the dealer knows exactly which unit you have, he may be able to offer suggestions over the phone, or save valuable time through knowledgeable preparation for the service call.

IN CASE OF TROUBLE

If, after performing the above, unit performance is unsatisfactory, shut off the unit and call your dealer.

Dealer's Name _____

Telephone No. _____

Unit Model _____

Unit Serial Number _____

Unit Address _____

Bus Number _____