

SANYO

INSTRUCTION MANUAL

MDF-594C
MDF-794C

Ultra-Low Temperature Freezer

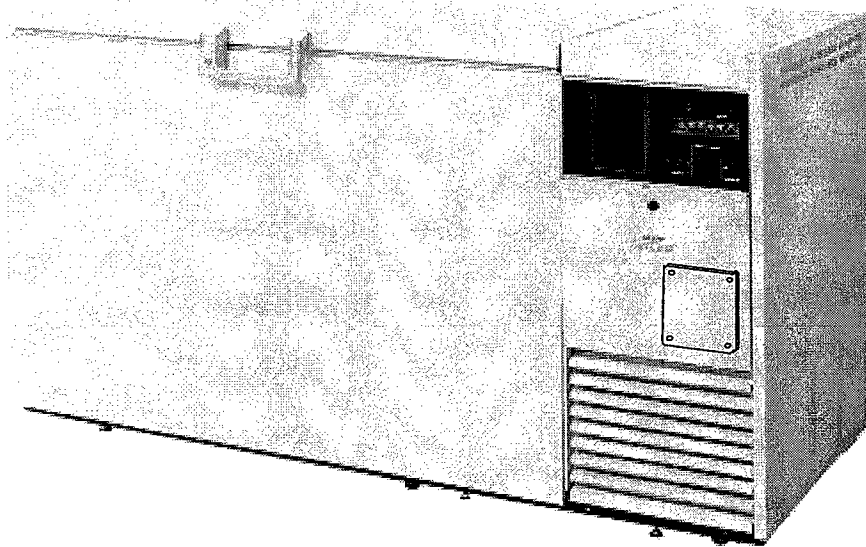

MDF-594C

CONTENTS

INTRODUCTION	P. 2
PRECAUTIONS FOR SAFE OPERATION	P. 3
ENVIRONMENTAL CONDITIONS	P. 7
FREEZER COMPONENTS	P. 8
Control panel	P. 10
INSTALLATION SITE	P. 11
INSTALLATION	P. 12
START-UP OF UNIT	P. 13
CHAMBER TEMPERATURE SETTING	P. 14
REMOTE ALARM TERMINAL	P. 14
ALARM TEMPERATURE SETTING	P. 15
SETTING OF ALARM RESUME TIME	P. 16
ALARMS & SAFETY FUNCTIONS	P. 17
ROUTINE MAINTENANCE	
Cleaning of cabinet	P. 18
Cleaning of condenser filter	P. 18
Defrosting of inside wall	P. 18
TROUBLESHOOTING	P. 19
REPLACEMENT OF BATTERY	P. 20
DISPOSAL OF UNIT	P. 21
Recycle of battery	P. 21
TEMPERATURE RECORDER (OPTION)	P. 26
BACK-UP SYSTEM (OPTION)	P. 30
SPECIFICATIONS	P. 31
PERFORMANCE	P. 32
SAFETY CHECK SHEET	P. 33

INTRODUCTION

- Read this manual carefully before using the appliance and follow the instructions for safety operation.

- Sanyo never guarantee any safety if the appliance is used for any objects other than intended use or used by any procedures other than those mentioned in this manual.

- Keep this manual in an adequate place to refer to it as necessary.

- The contents of the manual will be subjected to change without notice due to the improvement of performance or functions.

- Contact Sanyo sales representative or agent if any page of the manual is lost or page order is incorrect.

- Contact Sanyo sales representative or agent if any point in this manual is unclear or if there are any inaccuracies.

- No part of this manual may be reproduced in any form without the expressed written permission of Sanyo.

PRECAUTIONS FOR SAFE OPERATION

It is imperative that the user complies with this manual as it contains important safety advice.

Items and procedures are described so that you can use this unit correctly and safely. If the precautions advised are followed, this will prevent possible injury to the user and any other person.

Precautions are illustrated in the following way:

WARNING

Failure to observe WARNING signs could result in a hazard to personnel possibly resulting in serious injury or death.

CAUTION

Failure to observe CAUTION signs could result in injury to personnel and damage to the unit and associated property.

Symbol shows;

 this symbol means caution.

 this symbol means an action is prohibited.

 this symbol means an instruction must be followed.

Be sure to keep this manual in a place accessible to users of this unit.

< Label on the unit >



This mark is labeled on the cover in which the electrical components of high voltage are enclosed to prevent the electric shock.















The cover should be removed by a qualified engineer or a service personnel only.

WARNING

As with any equipment that uses CO₂ gas, there is a likelihood of oxygen depletion in the vicinity of the equipment. It is important that you assess the work site to ensure there is suitable and sufficient ventilation. If restricted ventilation is suspected, then other methods of ensuring a safe environment must be considered. These may include atmosphere monitoring and warning devices.













PRECAUTIONS FOR SAFE OPERATION

WARNING

-  **Do not use the unit outdoors.** Current leakage or electric shock may result if the unit is exposed to rain water.
-  **Only qualified engineers or service personnel should install the unit.** The installation by unqualified personnel may cause electric shock or fire.
-  **Install the unit on a sturdy floor and take an adequate precaution to prevent the unit from turning over.** If the floor is not strong enough or the installation site is not adequate, this may result in injury from the unit falling or tipping over.
-  **Never install the unit in a humid place or a place where it is likely to be splashed by water.** Deterioration of the insulation may result which could cause current leakage or electric shock.
-  **Never install the unit in a flammable or volatile location.** This may cause explosion or fire.
-  **Never install the unit where acid or corrosive gases are present** as current leakage or electric shock may result due to corrosion.
-  **Always ground (earth) the unit to prevent electric shock.** If the power supply outlet is not grounded, it will be necessary to install a ground by qualified engineers.
-  **Never ground the unit through a gas pipe, water main, telephone line or lightning rod.** Such grounding may cause electric shock in the case of an incomplete circuit.
-  **Connect the unit to a power source as indicated on the rating label attached to the unit.** Use of any other voltage or frequency other than that on the rating label may cause fire or electric shock.
-  **Never store volatile or flammable substances** in this unit if the container cannot be sealed. These may cause explosion or fire.
-  **Do not insert metal objects such as a pin or a wire into any vent, gap or any outlet on the unit.** This may cause electric shock or injury by accidental contact with moving parts.
-  **Use this unit in safe area when treating the poison, harmful or radiate articles.** Improper use may cause bad effect on your health or environment.
-  **Turn off the power switch (if provided) and disconnect the power supply to the unit prior to any repair or maintenance** of the unit in order to prevent electric shock or injury.
-  **Do not touch any electrical parts (such as power supply plug) or operate switches with a wet hand.** This may cause electric shock.

PRECAUTIONS FOR SAFE OPERATION







WARNING

-  **Ensure you do not inhale or consume medication or aerosols** from around the unit at the time of maintenance. These may be harmful to your health.
-  **Never splash water directly onto the unit** as this may cause electric shock or short circuit.
-  **Never put containers with liquid on the unit** as this may cause electric shock or short circuit when the liquid is spilled.
-  **Never bind, process, or step on the power supply cord, or never damage or break the power supply plug.** A broken supply cord or plug may cause fire or electric shock.
-  **Do not use the supply cord if its plug is loose.** Such supply cord may cause fire or electric shock.
-  **Never disassemble, repair, or modify the unit yourself.** Any such work carried out by an unauthorized person may result in fire, or electric shock or injury due to a malfunction.
-  **Disconnect the power supply plug if there is something wrong with the unit.** Continued abnormal operation may cause electric shock or fire.
-  **When removing the plug from the power supply outlet, grip the power supply plug, not the cord.** Pulling the cord may result in electric shock or fire by short circuit.
-  **Disconnect the power supply plug** before moving the unit. Take care not to damage the power cord. A damaged cord may cause electric shock or fire.
-  **Disconnect the power plug when the unit is not used for long periods.** Keeping the connection may cause electric shock, current leakage, or fire due to the deterioration of insulation.
-  **If the unit is to be stored unused in an unsupervised area for an extended period, ensure that children do not have access and that doors cannot be closed completely.**
-  **The disposal of the unit should be accomplished by appropriate personnel.** Remove doors to prevent accidents such as suffocation.
-  **Do not put the packing plastic bag within reach of children** as suffocation may result.

PRECAUTIONS FOR SAFE OPERATION



CAUTION

-  **Use a dedicated power source** (a dedicated circuit with a breaker) as indicated on the rating label attached to the unit. A branched circuit may cause fire resulting from abnormal heating.
-  **Connect the power supply plug to the power source firmly after removing the dust on the plug.** A dusty plug or improper insertion may cause a heat or ignition.
-  **Never store corrosive substances such as acid or alkali** in this unit if the container cannot be sealed. These may cause corrosion of inner components or electric parts.
-  **Check the setting when starting up of operation after power failure or turning off of power switch.** The stored items may be damaged due to the change of setting.
-  **Be careful not to tip over the unit** during movement to prevent damage or injury.
-  **Prepare a safety check sheet** when you request any repair or maintenance for the safety of service personnel.

ENVIRONMENTAL CONDITIONS

This equipment is designed to be safe at least under the following conditions (based on the IEC-1010-1):

- Indoor use;
- Altitude up to 2000 m;
- Ambient temperature 5°C to 40°C
- Maximum relative humidity 80% for temperature up to 31°C decreasing linearly to 50% relative humidity at 40°C;
- Mains supply voltage fluctuations not to exceed $\pm 10\%$ of the nominal voltage;
- Other supply voltage fluctuations as stated by the manufacturer;
- Transient overvoltages according to Installation Categories (Overvoltage Categories) II; For mains supply the minimum and normal category is II;
- Pollution degree 2 in accordance with IEC 664.

FREEZER COMPONENTS

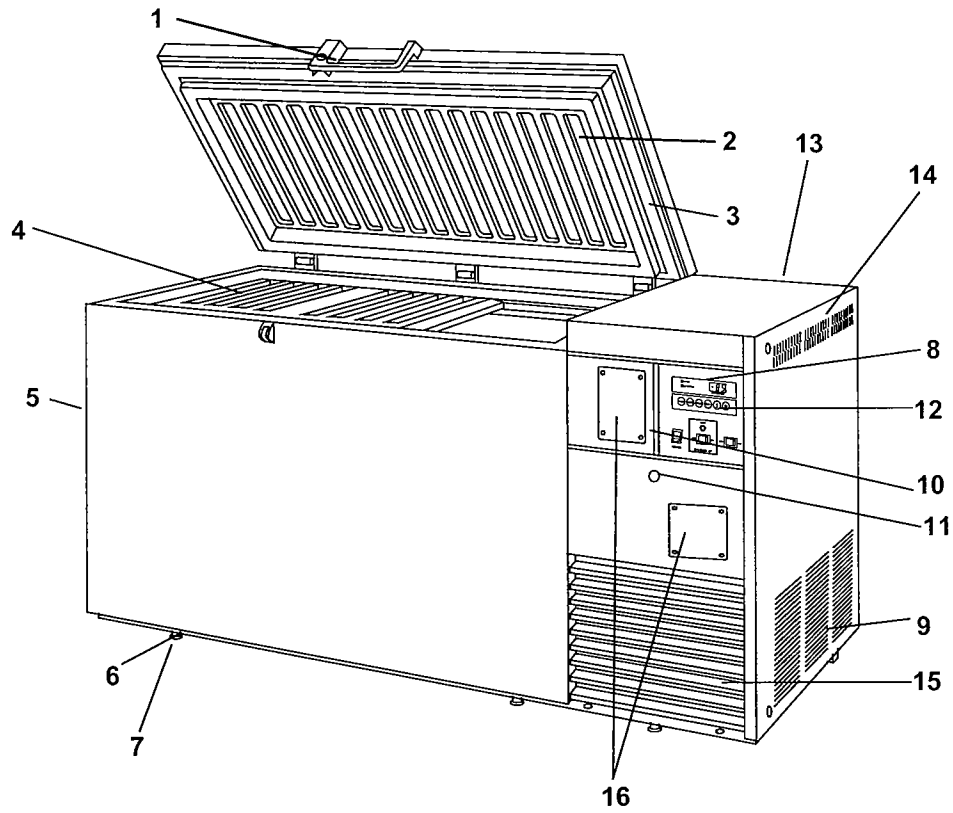

MDF-594C

FREEZER COMPONENTS

1. **Lock**
2. **Door:** Hinged type. The door can be opened in any angle on the way to full open.
3. **Magnetic door gasket:** Seals the door and prevents leakage of cold air.
4. **Inner lid:** Serves as a means of reducing cold air leakage when the door is open. Remove the frost before it is accumulated too much.
5. **Access port:** Serves as a means of leading the measuring cable from the freezing room to the outside.
6. **Caster:** 4 casters are provided. They make the moving of the unit easier.
7. **Leveling foot:** Serves to adjust the height and to settle the frame.
8. **Temperature display area:** The digital temperature indicator, alarm lamp, and filter check lamp are installed.
9. **Exhaust air vent:** Be careful not to block this.
10. **Control panel cover**
11. **Control panel cover lock:** To lock the control panel cover to avoid the setting by accidental contact.
12. **Control panel:** Temperature set key, power switch and so on are installed. Refer to page 10 for details.
13. **Back-up system joint (rear side):** It is positioned at rear of the unit. Serves to connect with the pipelines from the liquid CO₂ cylinder.
14. **Side panel:** For cleaning the condenser filter and condenser. The remote alarm terminal is located inside the panel.
15. **Air intake vent (grille):** Do not block this vent to keep the proper cooling performance.
16. **Space for temperature recorder:** An automatic temperature recorder can be attached here. (See page 26 to 29)

FREEZER COMPONENTS

Control panel

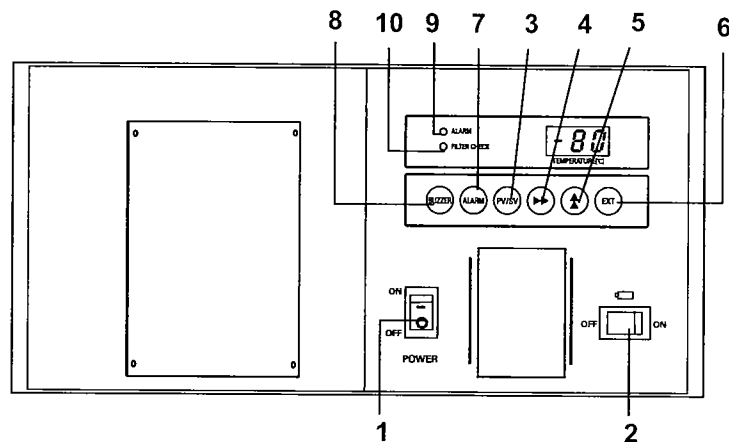

1. **Power switch (POWER):** Power all functions except remote alarm and back-up system (Option).
2. **Battery switch:** It is the switch of the battery for the power failure alarm. Turn it on usually. Turn it off when you do not drive for a long time. (More than 1 month)
3. **Temperature setting key. (PV/SV):** This key has functions.
 - PV: Present freezer compartment temperature is displayed.**
 - SV: Setting temperature is displayed.** When the desired temperature is set, this key should be pressed (SV side). The temperature setting can be done by using (4),(5),(6), keys, initial setting temperature is -80°C.
4. **Digit shift key (▶▶):** The digit of the figure displayed for temperature adjustment can be shifted using this key.
5. **Numerical value shift key (▲):** The figure that is displayed digitally can be changed by pressing this key.
6. **Enter key (ENT):** When the desired temperature is reached, press this key. Operation will commence toward this new point.
7. **Alarm test key (ALARM):** Check that the alarm lamp and the buzzer are functional when the freezer is operating well.
8. **Alarm buzzer stop key (BUZZER):** To stop the alarm from sounding, press this key. Should a further abnormality occur, the buzzer will sound automatically.
9. **Alarm lamp (ALARM) and buzzer:** they operate in the following cases:
 - a) Break down or power failure at the power supply.
 - Alarm lamp blinks, buzzer sounds.
 - b) Temperature rises about 10°C higher than the setting temperature.
 - Alarm lamp blinks, buzzer sounds about 12 minutes later.
10. **Filter check lamp (FILTER CHECK):** This lamp blinks and buzzer sounds when the condenser filter is clogged. Clean the condenser filter according to page 18 "Cleaning of condenser filter".

INSTALLATION SITE

To operate this unit properly and to obtain maximum performance, install the unit in a location with the following conditions:

■ **A location not subjected to direct sunlight**

Do not install the unit under direct sunlight. Installation in a location subjected to direct sunlight cannot obtain the intended performance.

■ **A location with adequate ventilation**

Leave at least 10 cm around the unit for ventilation. Poor ventilation will result in a reduction of the performance and consequently the failure.

■ **A location away from heat generating sources**

Avoid installing the unit near heat-emitting appliances such as a heater or a boiler etc. Heat can decrease the intended performance of the unit.

■ **A location with little temperature change**

Install the unit under stable ambient temperature. The allowable ambient temperature is between -5 and +35°C.

■ **A location with a sturdy and level floor**

Always install the unit on a sturdy and level floor. The uneven floor or tilted installation may cause failure or injury. Install the unit in stable condition to avoid the vibration or noise. Unstable condition may cause vibration or noise.

 **WARNING**

Install the unit on a sturdy floor. If the floor is not strong enough or the installation site is not adequate, this may result in injury from the unit falling or tipping over.

Select a level and sturdy floor for installation. This precaution will prevent the unit from tipping. Improper installation may result in water spillage or injury from the unit tipping over.

■ **A location not prone to high humidity**

Install the unit in the ambient of 80% R.H. or less humidity. Installation under high humidity may cause current leakage or electric shock.

 **WARNING**

Do not use the unit outdoors. Current leakage or electric shock may result if the unit is exposed to rain water.

Never install the unit in a humid place or a place where it is likely to be splashed by water. Deterioration of the insulation may result which could cause current leakage or electric shock.

■ **A location without flammable or corrosive gas**

Never install the unit in a flammable or volatile location. This may cause explosion or fire or may result in the current leakage or electric shock by the corrosion of the electrical components.

■ **A location without the possibility of anything fall**

Avoid installing the unit in the location where anything can fall down onto the unit. This may cause the breakdown or failure of the unit.

INSTALLATION

1. Removing the packaging materials and tapes

Remove all transportation packaging materials and tapes. Open the doors and ventilate the unit. If the outside panels are dirty, clean them with a diluted neutral dishwashing detergent. (Undiluted detergent can damage the plastic components. For the dilution, refer to the instruction of the detergent.) After the cleaning with the diluted detergent, always wipe it off with a wet cloth. Then wipe off the panels with a dry cloth.

2. Adjusting the leveling foot

Extend the leveling feet by rotating them counterclockwise to contact them to the floor. Ensure the unit is level.

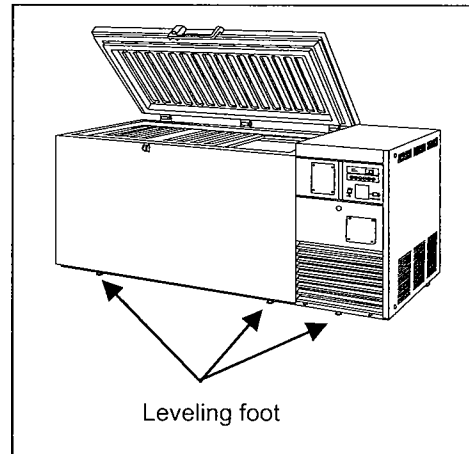

3. Fixing the unit

Two fixtures are attached to the rear of the frame. Fix the frame to the wall with these fixtures and rope or chain.

4. Ground (earth)

The ground (earth) is for preventing the electric shock in the case of the electrical insulation is somehow degraded. Always ground the unit at the time of installation.

⚠️ WARNING

Use a power supply outlet with ground (earth) to prevent electric shock. If the power supply outlet is not grounded, it is necessary to install a ground by qualified engineers.

Never ground the unit through a gas pipe, water main, telephone line or lightning rod. Such grounding may cause electric shock in the case of an incomplete circuit.

START-UP OF UNIT

Follow the procedures for the initial and consequent operations of the unit.

1. Make sure that all the switches on the control panel, such as the power switch, the battery switch, the CO₂ back-up system switch (option) are off.
2. Liquid CO₂ gas cylinder is set at this time.
3. Shut the door and connect the power cable to the power supply after the inner lid is installed.
4. Turn on the power switch and the temperature is displayed on the digital indicator.
5. Set the desired chamber temperature by using the keypads on the control panel. Do not set the chamber temperature at lower than -90°C.
6. Set the temperature at which the back-up system activates according to the procedure on page 30 when the back-up system temperature setting knob corresponds with the desired temperature if the back-up system is used.
7. Switch on the CO₂ back-up system switch.(option)
8. Check that the alarm lamp lights and the buzzer sounds by pressing the alarm test key.
9. Make sure that liquid CO₂ spouts into the chamber by pushing the back-up test switch.(option)
10. Now you can put articles into the freezer chamber. Switch off the CO₂ back-up system switch(option) temporarily when putting in a lot of warm articles. Switch on these switches again after a certain period of operation.

Operation after power failure



The set value is memorized by nonvolatile memory in the event of power failure. Accordingly, the freezer resumes the operation with setting before power failure.

CHAMBER TEMPERATURE SETTING

Table 1 shows the basic operation method. Perform key operations in the sequence indicated in the table. The example in the table is based on the assumption that the temperature is -70°C .

Note: The unit is set at the factory that the chamber temperature is -80°C .

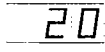
Table 1. Basic operation sequence (Example: Chamber temperature -70°C)

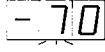
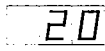
	Description of operation	Key operated	Indication after operation
1	Turn on the power switch.	----	The current chamber temperature is displayed. 
2	Press temperature setting key when changing the set temperature during operation.	PV/SV	The second digits blinks. 
3	Set the second digit to 7 with the numerical value shift key.		When pressed the figure of settable digit changes. 
5	Press enter key.	ENT	Set temperature is memorized and the current chamber temperature is displayed. 

Note: The temperature set mode returns to the temperature display mode automatically when 90 seconds has passed without any key operation.

REMOTE ALARM TERMINAL

The terminal of the remote alarm is located at rear of the machinery room, upper side of the electric box. The signal is contact output. The recommended contact capacity is between 2 A (DC 30 V).

- a) Contact output: normal open connect with N.O. and COM.
- b) Contact output: normal close connect with N.C. and COM.

Consult our dealer or our office for installation of the remote alarm.

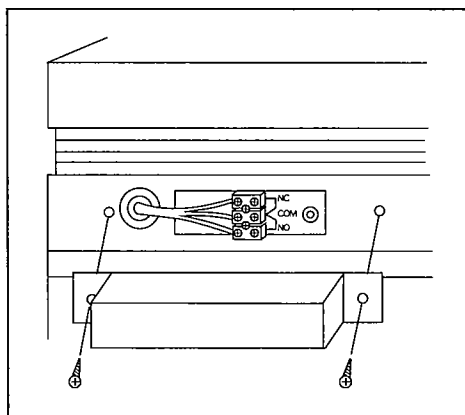

ALARM TEMPERATURE SETTING

This unit is provided with the high temperature alarm. The setting of high temperature alarm is 10°C or 15°C higher than the setting of chamber temperature. The procedure in table 2 shows the sequence to set the high temperature alarm at 15°C higher than the setting of chamber temperature. Set the figure to 000 at step 5 when setting the high temperature alarm at 10°C higher than the setting of chamber temperature.

Note:

The alarm temperature is set at the factory 10°C higher than the setting of chamber temperature.

Table 2. High temperature alarm setting (15°C higher than the setting of chamber temperature)

	Description of operation	Key operated	Indication after operation
1		----	The current chamber temperature is displayed.
2	Press the numerical value shift key for about 5 seconds.		The first digit blinks.
3	Set the first digit to 1 with the numerical value shift key.		The first digit blinks.
4	Press enter key.	ENT	The first digit blinks.
5	Set the first digit to 1 with the numerical value shift key.		When pressed, the figure of settable digit changes.
6	Press enter key.	ENT	Alarm temperature is memorized and the current chamber temperature is displayed.

Note: The setting is not memorized if the temperature setting key (PV/SV) is pressed during alarm temperature setting. The chamber temperature is displayed for 3 seconds when the numerical value shift key is pressed 5 times for 5 seconds.

SETTING OF ALARM RESUME TIME

The alarm buzzer is silenced by pressing alarm buzzer stop key (BUZZER) on the control panel during alarm.

The buzzer will be activated again after certain suspension if the alarm condition is continued. The suspension time can be set by following the procedure shown in the table 3 below.

The example in the table is based on the assumption that the desired duration is 20 minutes.

Note: The duration is set in 30 minutes (Initial setting 130) at the factory.

Table 3. Setting procedure (change from 30 minutes to 20 minutes)

	Description of operation	Key operated	Indication after operation
1		----	The current chamber temperature is displayed.
2	Press the numerical value shift key for about 5 seconds.	▲	The first digit blinks.
3	Set to F25 with the digit shift key and numerical value shift key.	▶▶	The settable digit is shifted.
		▲	When pressed, the figure of settable digit changes.
4	Press enter key.	ENT	The current setting is displayed and the first digit blinks.
5	Set to 130 with the digit shift key and numerical value shift key.	▶▶	The settable digit is shifted.
		▲	When pressed, the figure of settable digit changes.
6	Press enter key.	ENT	Alarm resume time is memorized and the current chamber temperature is displayed.

- The settable alarm resume time is between 10 and 60 minutes with 1 minute increment. (The setting is 110, 111, ----- 159, 160). The buzzer would not reset if the resume time is set in 100.
- The buzzer is ON when the resume time is changed in F25 while the resume time is counted (the buzzer is silenced by alarm buzzer stop key (BUZZER)). The count of resume time is stopped.
- The setting cannot be changed during power failure.
- The set mode returns to the temperature display mode automatically when 90 seconds has passed without any key operation. In this case, any setting before pressing enter key (ENT) is not memorized.
- It is selectable whether the buzzer is in conjunction with the remote alarm or not when the buzzer is silenced by alarm buzzer stop key (BUZZER). (The remote alarm is not in conjunction with the buzzer by factory setting.)
- The remote alarm is activated in conjunction with the buzzer if the third digit "1" is set to "0" in the step 5 above.

ALARMS & SAFETY FUNCTIONS

This unit has the alarm and safety functions shown in table below, and also self diagnostic function.

Table 4. Alarm and safety function

Alarm & safety	Situation	Indication	Buzzer	Safety operation
High temperature alarm	When the chamber temp. is approx. 10°C (or 15°C) higher than the set temp.	Alarm lamp blinks.	Intermittent tone with 12 min. delay.	Remote alarm with 12 min. delay.
Power failure alarm	At power failure When power cord is disconnected.	Alarm lamp blinks.	Intermittent Tone.	Remote alarm.

ALARMS & SAFETY FUNCTIONS

Table 4. Alarm and safety function

Alarm & safety	Situation	Indication	Buzzer	Safety operation
Filter check	When the condenser filter is clogged.	Filter check lamp blinks.	Intermittent Tone.	-----
Auto-return	When there is no key pressing in each setting mode for 90 seconds.	Chamber temp. is displayed.	-----	Finishing of each setting mode.
Sensor abnormality	If the thermal sensor is disconnected.	Alarm lamp blinks. E01 and 50°C is displayed alternately.	Intermittent tone	Remote alarm Continuous operation
	If the thermal sensor is short-circuited.	Alarm lamp blinks. E02 and -170°C are displayed alternately.		
	If the cascade sensor is disconnected.	Alarm lamp blinks. E03 and chamber temp. are displayed alternately.	Intermittent tone	Remote alarm
	If the cascade sensor is short-circuited.	Alarm lamp blinks. E04 and chamber temp. are displayed alternately.		
	If the filter sensor is disconnected.	Alarm lamp blinks. E05 and chamber temp. are displayed alternately.	Intermittent tone	Remote alarm
	If the filter sensor is short-circuited.	Alarm lamp blinks. E06 and chamber temp. are displayed alternately.		
	If the ambient temperature sensor is disconnected.	Alarm lamp blinks. E07 and chamber temp. are displayed alternately.	Intermittent tone	Remote alarm
	If the ambient temperature sensor is short-circuited.	Alarm lamp blinks. E08 and chamber temp. are displayed alternately.		
Condenser temp. abnormality	In the event of failure of fan motor for cooling the compressor	E10 and chamber temp. are displayed alternately.	Intermittent tone	Remote alarm. Compressor of high stage side stops.
Battery life	About 3 years after turning on the power switch.	F1 and chamber temp. are displayed alternately.	-----	-----
Filter life	About 6 years after turning on the power switch.	F2 and chamber temp. are displayed alternately.	-----	-----

Note:

The filter check lamp sometimes blinks at the start-up under high ambient temperature. The lamp is off when the chamber temperature is getting lower.

The error alarm explanation of the thermal sensor (in the chamber).

Indicated value	Contents of a trouble
E01	When sensor lead wire (red) is opened.
E02	When sensor lead wire (red) is short-circuited.
	When sensor lead wire (white) or (black) is opened.

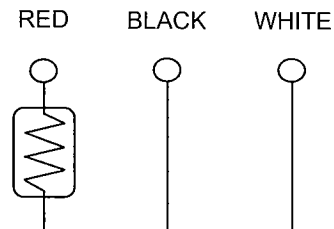

ROUTINE MAINTENANCE

WARNING

Always disconnect the power supply to the unit prior to any repair or maintenance of the unit in order to prevent electric shock or injury.

Ensure you do not inhale or consume medication or aerosols from around the unit at the time of maintenance. These may be harmful to your health.

Cleaning of cabinet

- Clean the unit once a month. Regular cleaning keeps the unit looking new.
- Use a dry cloth to wipe off small amounts of dirt on the outside and inside of the unit and all accessories. If the outside panels are dirty, clean them with a diluted neutral dishwashing detergent. (Undiluted detergent can damage the plastic components. For the dilution, refer to the instruction of the detergent.) After the cleaning with the diluted detergent, always wipe it off with a wet cloth. Then wipe off the cabinet or accessories with a dry cloth.
- Never pour water onto or into the unit. Doing so can damage the electric insulation and cause failure.
- The compressor and other mechanical parts are completely sealed. This unit requires absolutely no lubrication.
- Check the back-up system by pressing CO₂ back-up test switch (TEST) once a month if it is installed.
- Remove the frost or ice on the chamber wall and clean the condenser filter once a month.

Cleaning of condenser filter

This unit is provided with the filter check lamp. This lamp blinks when the condenser filter is clogged. Clean the filter according to the following procedure. As a clogged filter may cause poor cooling and compressor trouble, clean it once a month.

1. The filter fitted to the grille can be removed as shown in the figure.
2. Wash it with water and dry it naturally.
3. Replace the clean filter as before.
4. Replace the grille in the basic position and check that the filter check lamp is off.

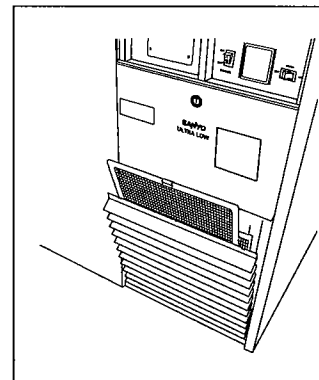

Defrosting of inside wall

Defrost the inside wall of the freezer as follows:

Normal defrosting

Remove the frost by the enclosed scraper. Take care not to damage the inside wall.

Thorough defrosting

1. Take out and transfer all the contents to another freezer or container which contains liquid CO₂, liquid N₂, or dry ice. Switch off the alarm and back-up system. Switch off the power switch.
2. Open the door and remove the inner lid. Leave the freezer as it is. The water remaining in the freezer compartment should be wiped up.
3. After cleaning is completed, restart the operation according to the procedure on page 13. Put back the articles into the sufficiently cooled freezer compartment.

TROUBLESHOOTING

If the unit malfunctions, check out the following before calling for service.

Malfunction	Check/Remedy
The chamber is not cooled at all	<ul style="list-style-type: none"> ▪ The voltage is too low. (In this case, call an electrician.) ▪ The breaker is free. ▪ The fuse is blown. <p>Sometimes the freezer is not cooled at all for about 5 minutes after starting-up.</p>
The cooling is poor	<ul style="list-style-type: none"> ▪ The ambient temperature is too high. ▪ The door is not shut tightly. ▪ The inner lid is not installed correctly. ▪ The set temperature in the controller is not set properly. ▪ The grille is blocked out. ▪ The filter is clogged. Clean the filter when the filter check lamp blinks. ▪ The freezer is in the direct sunlight. ▪ There is any heating source near the freezer. ▪ A rubber cap and insulation for the access port are not set correctly. ▪ You put too many unfrozen articles into the freezer compartment. ▪ Too much frost is accumulated in the chamber.
Alarm test key cannot actuate the alarm	<ul style="list-style-type: none"> ▪ The alarm test key does not function when the power switch of the freezer is OFF. ▪ When only the buzzer or only the alarm is actuated by the alarm test key, the unactuated part is out of order, and must be replaced.
Noise	<ul style="list-style-type: none"> ▪ The freezer is not installed on the sturdy floor. ▪ There is anything touching the frame. ▪ The freezer is not leveled with the leveling feet. ▪ It is the immediately after starting of refrigeration. <p>The freezer causes larger noise when the chamber temperature is high because of large load. The noise gets smaller along with chamber temperature.</p>
CO ₂ back-up test switch does not operate normally (when the back-up system is provided)	<ul style="list-style-type: none"> ▪ The liquid CO₂ cylinder is empty. ▪ The valve of the liquid CO₂ cylinder is not opened. ▪ The ambient temperature is too high. In this case, move the liquid CO₂ cylinder to a cool location. <p>Inquire at liquid CO₂ suppliers about cylinder check, adjustment, installation, or move.</p>

Note:

If the malfunction is not eliminated after checking the above items, or the malfunction is not shown in the above table, contact Sanyo sales representative or agent.

REPLACEMENT OF BATTERY

Location of a nickel-cadmium battery

This unit is provided a nickel-cadmium battery for the power failure alarm. The battery is located in the control box behind the control panel.(Fig. 1)



The high voltage components are enclosed in the control box. The cover should be removed by a qualified engineer or a service personnel only to prevent the electric shock..

Removal of nickel-cadmium battery

1. Turn off the power switch and battery switch and disconnect the power supply plug.
2. As shown in the Fig.2, remove 4 fixing screws on the side panel and remove the side panel.
3. Loosen 2 upper screws and remove 2 screws on the right, and remove control box cover. (Fig. 3)
4. Remove 4 fixing screws on the control box to remove the control box cover. (Fig. 3)
5. Remove 2 screw fixing the clips securing the battery and then disconnect the connector. (Fig. 4)

Handling of battery

Cover the battery terminal with an insulating tape to avoid the short circuit. Then follow the procedure for recycling or proper disposal.

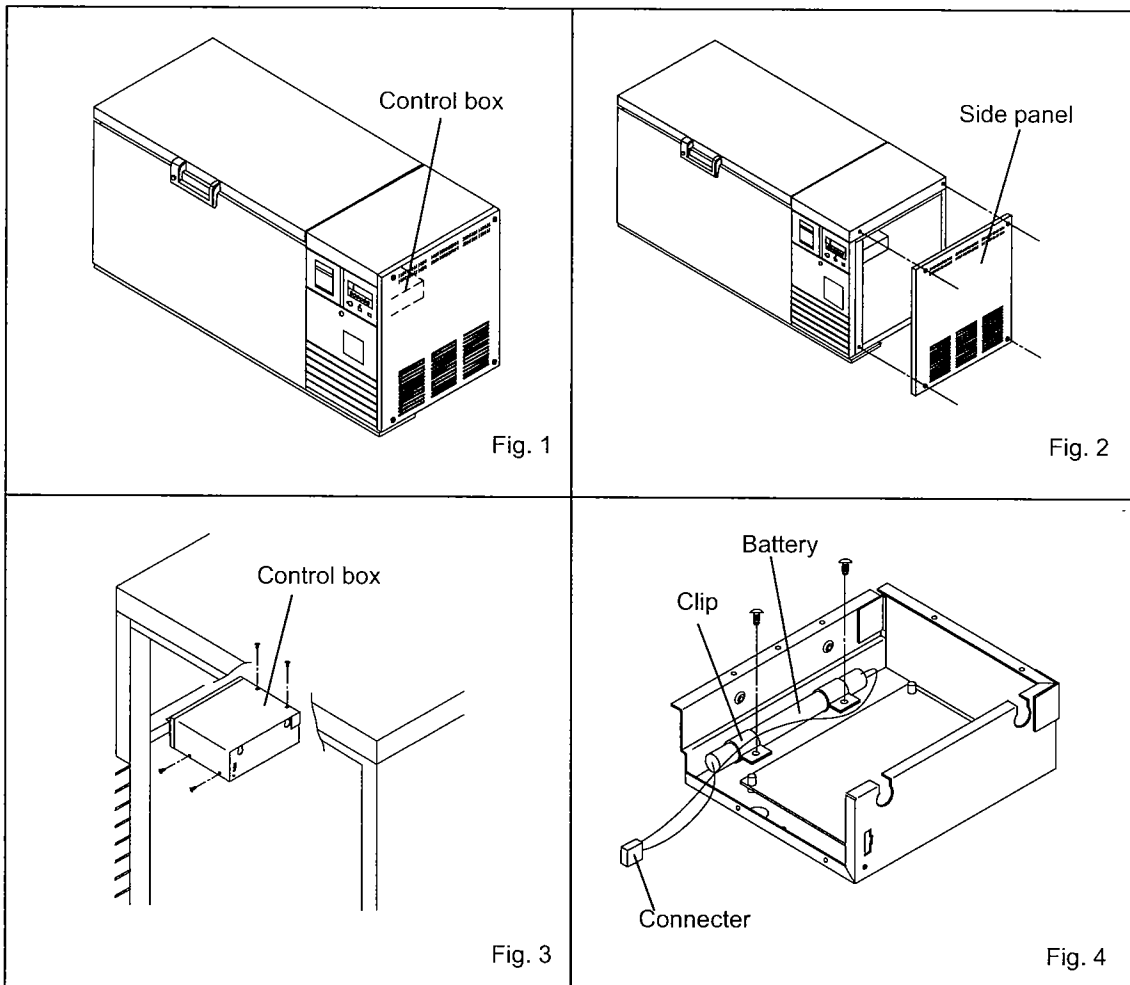

DISPOSAL OF UNIT

WARNING

If the unit is to be stored unused in an unsupervised area for an extended period **ensure that children do not have access and doors cannot be closed completely.**

The disposal of the unit should be accomplished by appropriate personnel. Always remove doors to prevent accidents such as suffocation.

Recycle of battery

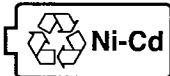

The unit contains a rechargeable battery. The battery is recyclable. At the end of its useful life, check with your local solid waste officials for proper disposal.



* Label indication is obliged to comply with Taiwanese battery regulation.

DISPOSAL OF UNIT

Note:

This symbol mark and recycle system are applied only to EU countries and not applied to the countries in the other area of the world.

Waste Electrical and Electronic Equipment (WEEE) Directive-2002/96/EC

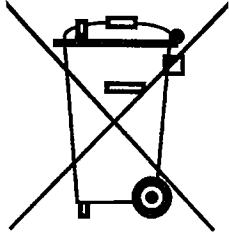

(English)

Your SANYO product is designed and manufactured with high quality materials and components which can be recycled and reused.

This symbol means that electrical and electronic equipment, at their end-of-life, should be disposed of separately from your household waste.

Please dispose of this equipment at your local community waste collection/recycling centre.

In the European Union there are separate collection systems for used electrical and electronic products.

Please help us to conserve the environment we live in!

(German)

Ihr SANYO Produkt wurde entworfen und hergestellt mit qualitativ hochwertigen Materialien und Komponenten, die recycelt und wiederverwendet werden können.

Dieses Symbol bedeutet, daß elektrische und elektronische Geräte am Ende ihrer Nutzungsdauer von Hausmüll getrennt entsorgt werden sollen.

Bitte entsorgen Sie dieses Gerät bei Ihrer örtlichen kommunalen Sammelstelle oder im Recycling Centre.

In der Europäischen Union gibt es unterschiedliche Sammelsysteme für Elektrik- und Elektronikgeräte.

Helfen Sie uns bitte, die Umwelt zu erhalten, in der wir leben!

DISPOSAL OF UNIT

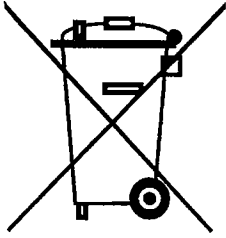

(French)

Votre produit Sanyo est conçu et fabriqué avec des matériaux et des composants de qualité supérieure qui peuvent être recyclés et réutilisés.

Ce symbole signifie que les équipements électriques et électroniques en fin de vie doivent être éliminés séparément des ordures ménagères.

Nous vous prions donc de confier cet équipement à votre centre local de collecte/recyclage. Dans l'Union Européenne, il existe des systèmes sélectifs de collecte pour les produits électriques et électroniques usagés.

Aidez-nous à conserver l'environnement dans lequel nous vivons !

Les machines ou appareils électriques et électroniques contiennent fréquemment des matières qui, si elles sont traitées ou éliminées de manière inappropriée, peuvent s'avérer potentiellement dangereuses pour la santé humaine et pour l'environnement.

Cependant, ces matières sont nécessaires au bon fonctionnement de votre appareil ou de votre machine. Pour cette raison, il vous est demandé de ne pas vous débarrasser de votre appareil ou machine usagé avec vos ordures ménagères.

(Spanish)

Los productos SANYO están diseñados y fabricados con materiales y componentes de alta calidad, que pueden ser reciclados y reutilizados.

Este símbolo significa que el equipo eléctrico y electrónico, al final de su ciclo de vida, no se debe desechar con el resto de residuos domésticos.

Por favor, deposite su viejo "televisor" en el punto de recogida de residuos o contacte con su administración local.

En la Unión Europea existen sistemas de recogida específicos para residuos de aparatos eléctricos y electrónicos.

Por favor, ayúdenos a conservar el medio ambiente!

DISPOSAL OF UNIT

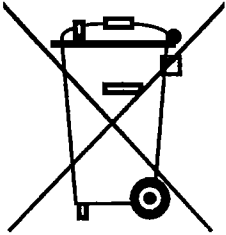

(Portuguese)

O seu produto SANYO foi concebido e produzido com materiais e componentes de alta qualidade que podem ser reciclados e reutilizados.

Este símbolo significa que o equipamento eléctrico e electrónico no final da sua vida útil deverá ser descartado separadamente do seu lixo doméstico.

Por favor, entregue este equipamento no seu ponto local de recolha/reciclagem.

Na União Europeia existem sistemas de recolha separados para produtos eléctricos e electrónicos usados.

Por favor, ajude-nos a conservar o ambiente em que vivemos!

(Italian)

Il vostro prodotto SANYO è stato costruito da materiali e componenti di alta qualità, che sono riutilizzabili o riciclabili.

Prodotti elettrici ed elettronici portando questo simbolo alla fine dell'uso devono essere smaltiti separatamente dai rifiuti casalinghi.

Vi preghiamo di smaltire questo apparecchio al deposito comunale.

Nell'Unione Europea esistono sistemi di raccolta differenziata per prodotti elettrici ed elettronici.

Aiutateci a conservare l'ambiente in cui viviamo!

(

DISPOSAL OF UNIT

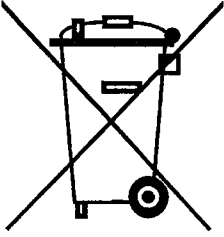

(Dutch)

Sanyo producten zijn ontwikkeld en gefabriceerd uit eerste kwaliteit materialen, de onderdelen kunnen worden gerecycled en weer worden gebruikt.

Het symbool betekent dat de elektrische en elektronische onderdelen wanneer deze vernietigd gaan worden, dit separaat gebeurt van het normale huisafval.

Zorg ervoor dat het verwijderen van de apparatuur bij de lokaal erkende instanties gaat gebeuren. In de Europese Unie wordt de gebruikte elektrische en elektronische apparatuur bij de daarvoor wettelijke instanties aangeboden.

Alstublieft help allen mee om het milieu te beschermen.

(Swedish)

Din SANYO produkt är designad och tillverkad av material och komponenter med hög kvalitet som kan återvinnas och återanvändas.

Denna symbol betyder att elektriska och elektroniska produkter, efter slutanvändande, skall sorteras och lämnas separat från Ditt hushållsavfall.

Vänligen, lämna denna produkt hos Din lokala mottagningsstation för avfall/återvinningsstation.

Inom den Europeiska Unionen finns det separata återvinningssystem för begagnade elektriska och elektroniska produkter.

Vänligen, hjälp oss att bevara miljön vi lever i!

TEMPERATURE RECORDER (Option)

The figure below shows the description of a temperature recorder.

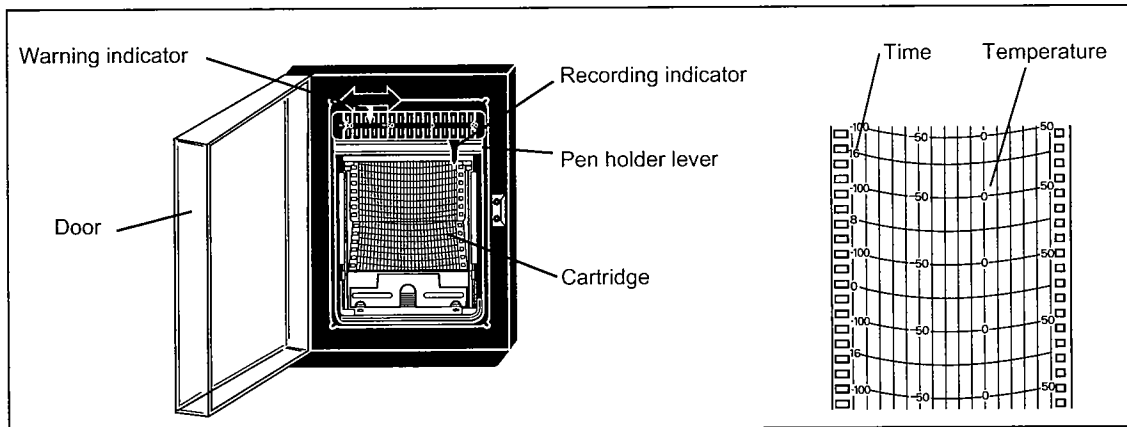

Feeding of chart

1. Open the door and let down the lever of the penholder; the pen point is apart from the chart. (Fig. 1)
2. Pull the cartridge out of the mounted position. (Fig. 2)
3. Set a new chart in place on the rear bottom of the cartridge. Set the hole on the chart in the cog of the chart driving assembly and feed the chart in the direction of the arrow by driving the cog wheel.
4. Set the chart according to the mark of day and time. (Fig. 3)
5. When mounting, lay down the cartridge first, and push into the mounting position with the groove set a the projection on the position.
6. Set up the cartridge and settle in position.

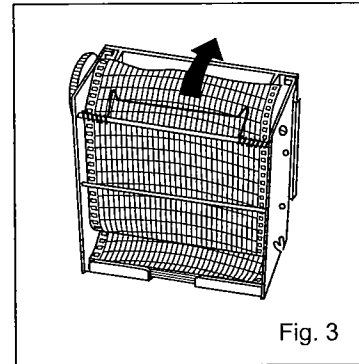
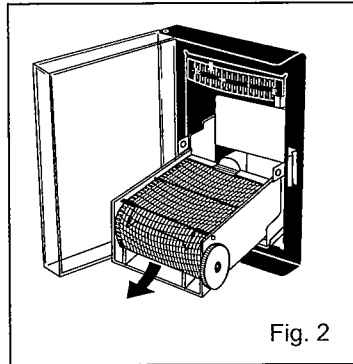
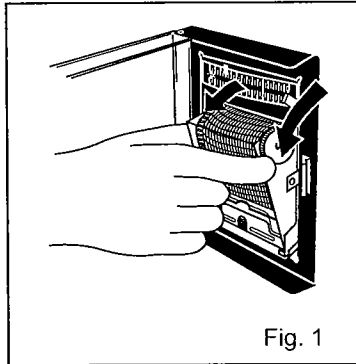

Replacement of cell

Replace the dry cell once a year as follows:

1. Put up the penholder first, then pull out cartridge from the mounted position.
2. Reset the battery chamber cover with wire, on the bottom left side, and take out the cell.
3. Set a new cell by turning its anode to this side.
4. Shut the cover after exchanging cells. Mount the cartridge as before and lay down the penholder.

Note :

This temperature recorder is designed for the manganese dry cell and the alkaline dry cell. Do not use a rechargeable battery because the initial voltage of such battery is low. The rechargeable battery may cause the malfunction of recorder or shorten the battery life significantly.

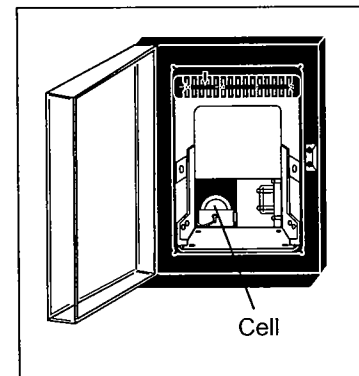

TEMPERATURE RECORDER (Option)

Setting of back-up temperature

1. There is a red guide on the top of the temperature displayer. Adjust the guide with your finger to back-up temperature, at which temperature the auxiliary cooling system starts to operate.
2. Set at a temperature 15°C higher than that of the freezer compartment.

Penholder

Install a recording pen in the recording hand as shown in the figure. Make sure that the pen is completely inserted for accurate recording. The pen is packed together with the chart.

1. Let down the lever of the penholder, then pull out the cartridge from the mounted position.
2. Insert a new pen.
3. Mount the cartridge into place.
4. Lift up the penholder lever and make sure that the pen point touches the chart.

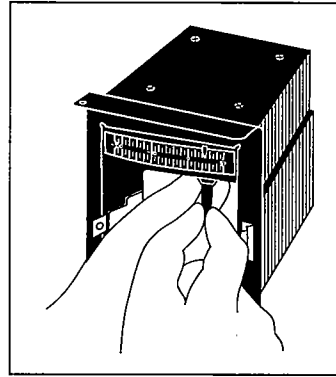

Note:

- Turn off the back-up switch when the freezer operation is stopped or the back-up system is not used. The battery for back-up system is discharged when the back-up switch is kept on.
- The additional felt pen or recording paper is available from Sanyo sales agency.
- To stop the temperature recorder, remove the cell from the recorder. The back-up system can operate without recorder cell. Always remove a felt pen as well because the recording paper can be torn resulting from ink spot. The torn paper may interfere pen tip movement, which results in no activation of back-up system.
- The cell for recorder normally keeps about 1 year. However, the cell life is shorten depending on the ambient temperature condition. The enclosed cell may have shorter life since it is for monitor.
- The liquid leakage or rust can be caused when a used cell or a cell over effective limit is left as it is, which gives adverse effect on the recorder.
- Operate the freezer until the chamber temperature gets to the set temperature. Check the recorded temperature and chamber temperature displayed on the control panel. Adjust the zero adjustment volume on the temperature recorder so that the recorded temperature can corresponds with the displayed temperature if they are not compliance each other.

TEMPERATURE RECORDER (Option)

When a 7-day circular type recorder is installed, a slip chart recorder can not be attached.

Follow the procedure bellow to attach a 7-day circular chart recorder to the freezer.

NOTE: Only a specified recorder is applicable to the freezer. For the selection of an applicable recorder, please consult with a sales representative or agent.

1. Make sure that all the switches including power supply are turned off.
2. Remove the side cover by loosening four screws. (Fig.1)
3. After removing a grille screw, open the grille as shown in Fig. 1.
4. Remove the control panel by loosening two screws on the lower outside (A) and upper inside (B) of the control panel. (Fig. 1)
5. Detach the cover on the control panel by removing four screws. (Fig. 1)
6. As shown in Fig.2, secure the temperature recorder to the control panel using with the fixing kit.

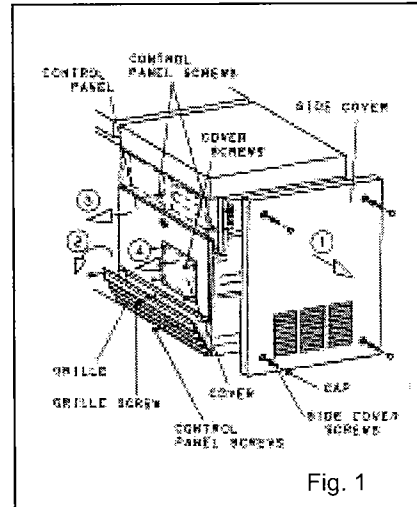

Fig. 1

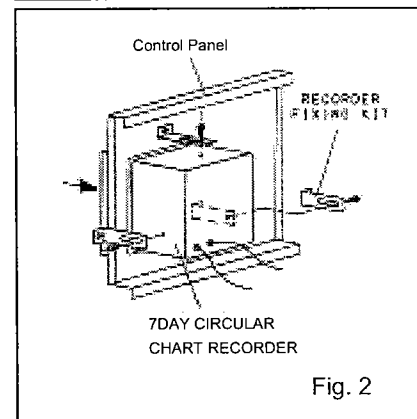

Fig. 2

7. Replace the control panel with the recorder attached and fix the panel with screws. (Fig. 3)

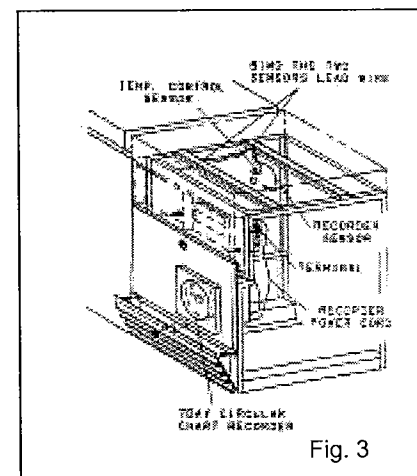
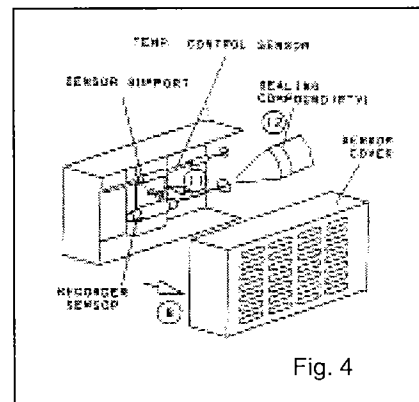

Fig. 3

TEMPERATURE RECORDER (Option)

8. Remove the sensor cover at the rear of the chamber wall.
(Fig. 4)



9. Pass through the hole under the temperature control sensor. (Fig. 5)
5) Tool for the hole: Screw driver (example) Hole depth: 135mm (5.3inch) Hole diameter: 13mm (0.5inch)

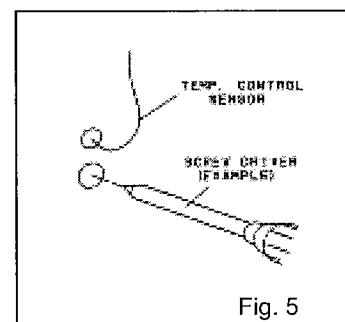

10. Route the recorder sensor into the chamber by passing the hole.
(Fig. 4)

11. Remove the sensor support and position the recorder sensor and then replace the stopper. (Fig. 4)

12. Seal around the hole for recorder sensor completely by applying the sealing compound (RTV) to outside and inside of the chamber. (Fig. 4)

13. Connect the power cord of the recorder to the terminal as shown in Fig. 6.

- | | | |
|---|---|---------|
| 1 | — | Neutral |
| 2 | — | Live |
| 3 | — | Earth |

14. Fix the grille with a screw and replace the side cover.

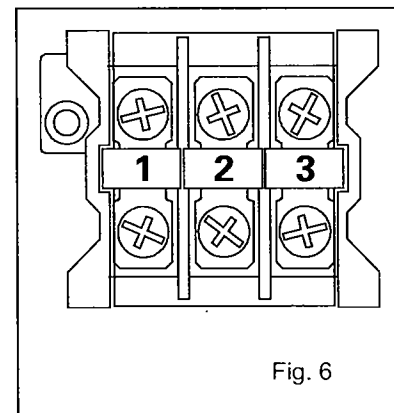

BACK-UP SYSTEM (Option)

WARNING

As with any equipment that uses CO₂ gas, there is a likelihood of oxygen depletion in the vicinity of the equipment. It is important that you assess the work site to ensure there is suitable and sufficient ventilation. If restricted ventilation is suspected, then other methods of ensuring a safe environment must be considered. These may include atmosphere monitoring and warning devices.

The freezer is provided with an automatic liquid CO₂ gas injection device as a back-up system. This freezer prevents the chamber temperature from going up by injecting the liquid CO₂ gas when the power supply is disconnected (power failure, disconnection of power cord, breaker OFF) or in the case of failure of freezer itself. The liquid CO₂ gas is injected with the activation of solenoid valve energized by battery when the chamber temperature reaches the alarm temperature.

Following shows the procedure for setting the back-up system.

1. Setting of liquid CO₂ gas cylinder

By using the joint and pipe enclosed with the freezer, connect the liquid CO₂ gas cylinder to the joint of the back-up system. For this setting, consult with a qualified gas supplier or Sanyo sales agency.

2. After setting the liquid CO₂ gas cylinder, operate the freezer until the chamber temperature reaches the required level.

3. Set the warning indicator of the temperature setting knob of the back-up system at the temperature higher than -70°C. The back-up system is operated continuously if the warning indicator is set at the temperature lower than -70°C. This means the liquid CO₂ gas is consumed very quickly.

4. Switch on the back-up system.

5. Make sure that liquid CO₂ gas spouts into the freezer chamber by pressing the back-up test switch.

Note:

- The liquid CO₂ gas cylinder loses its cooling capacity at speed when the ambient temperature is over 31°C. Install the liquid CO₂ gas cylinder in the cool environment. And the duration of back-up time per one liquid CO₂ gas cylinder varies depending on the ambient temperature. Refer to "Installation of back-up system" enclosed with the freezer for the available back-up time.
- The liquid CO₂ gas cylinder should be a siphon type.
- Use the pipe enclosed with the freezer for the setting. (The extension of the pipe is not permitted because of cooling capacity.)

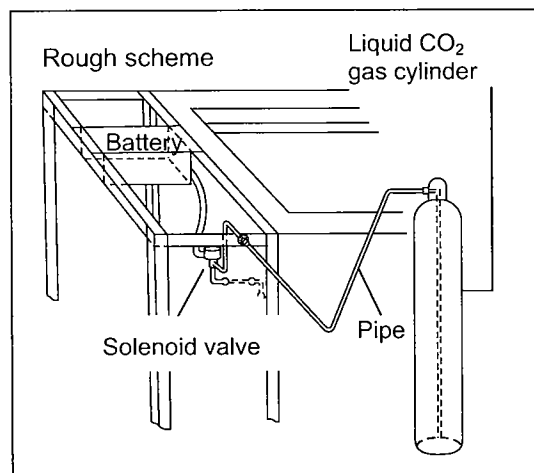

SPECIFICATIONS

Name	Ultra-Low Temperature Freezer	
Model	MDF-594C	MDF-794C
External dimensions	W2010 x D770 x H1070 (mm)	W2570 x D770 x H1070 (mm)
Internal dimensions	W1280 x D500x H762 (mm)	W1840 x D500x H762 (mm)
Effective capacity	487 L	701 L
Exterior	Painted steel	
Interior	Stainless steel	
Door	Painted steel	
Insulation	Rigid polyurethane foamed-in place	
Compressor	Hermetic type	
Motor for compressor	High stage side; 1100 W Low stage side; 1100 W	
Condenser	High stage side; fin and tube type, Low stage side; shell and tube type	
Evaporator	Tube on sheet type	
Refrigerant	High stage side; R-407D, Low stage side; R-508	
Power source	AC 220 V, 60 Hz	
Temperature controller	Microprocessor control system, Setting range; -20 to -95°C, 1°C graduation	
Temperature display	Digital display (+50 to -170°C)	
Sensor	Pt 100 Ω	
Alarm	High temp. alarm, Power failure alarm, Filter check	
Battery	For power failure alarm; Nickel-cadmium battery(5N-270AA); DC 6 V, 270 mAh	
Voltage booster	Electrical; 208/230 V, 1 HP, 60 Hz	
Accessories	1 set of key, 1 scraper	
Weight	303 kg	347 kg
Option	Aluminum container; MDF-59SC, Inventory rack; IR213C, IR309C Temperature recorder; MTR-85H Back-up system; (CVK-AT, CVK-UB2): LCO ₂ , (CVK-ATN, CVK-UBN2): LN ₂	

- Note:**
- Design or specifications will be subject to change without notice.
 - The battery for power failure alarm is an article for consumption. It is recommended that the battery will be replaced about every 3 years. Contact Sanyo sales representative or agent at the time of replacement of the battery for recycling.
 - A fan motor is expendable supplies. Exchange it for about every 6 years. Contact Sanyo sales representative or agent at the time of replacement of the fan motor

PERFORMANCE

Model	MDF-594C
Cooling performance	Center part of freezing room; -86°C (Ambient temperature; +30°C, no load)
Temperature Control range	-20 to -86°C
Power source	AC 220 V, 60 Hz
Rated power consumption	1120 W
Noise level	51 dB [A] (background noise; 20 dB)
Maximum pressure	1.70 Mpa

Note : The unit with CE mark complies with EC directives 89/336/EEC, 93/68/EEC and 73/23/EEC

Model	MDF-794C
Cooling performance	Center part of freezing room; -86°C (Ambient temperature; +30°C, no load)
Temperature Control range	-20 to -86°C
Power source	AC 220 V, 60 Hz
Rated power consumption	1210 W
Noise level	50 dB [A] (background noise; 20 dB)
Maximum pressure	1.80 MPa

Note : The unit with CE mark complies with EC directives 89/336/EEC, 93/68/EEC and 73/23/EEC

⚠ CAUTION

**Please fill in this form before servicing.
Hand over this form to the service engineer to keep for his and your safety.**

Safety check sheet

1. Freezer contents : Yes No
Risk of infection: Yes No
Risk of toxicity: Yes No
Risk from radioactive sources: Yes No

(List all potentially hazardous materials that have been stored in this unit.)

Notes :

2. Contamination of the unit:
Unit interior: Yes No
No contamination: Yes No
Decontaminated: Yes No
Contaminated: Yes No
Others:

3. Instructions for safe repair/maintenance of the unit
a) The unit is safe to work on Yes No
b) There is some danger (see below) Yes No

Procedure to be adhered to in order to reduce safety risk indicated in b) below.

Date :

Signature :

Address, Division :

Telephone :

Product name: Ultra-low temperature freezer	Model: MDF-594C MDF-794C	Serial number:	Date of installation:
---	--------------------------------	----------------	-----------------------

Please decontaminate the unit yourself before calling the service engineer.

SANYO