

# **Aleratec®**

**[www.aleratec.com](http://www.aleratec.com)**

*The Prosumers' Choice*

## **USER GUIDE**

### **Aleratec® HDD PortaCruiser™**



**Part No. 350108**

## Copyright/Model Identification

The content of this manual is for informational purposes only and is subject to change without notice.

This manual is copyright with all rights reserved. Under copyright laws, this manual and the software described within may not be copied, except in the normal use of the product(s) described within or to make a backup copy.

Copyright© 2009  
Aleratec, Inc.  
9851 Owensmouth Avenue  
Chatsworth, CA 91311 U.S.A.

[www.aleratec.com](http://www.aleratec.com)

Aleratec® is a registered trademark, and HDD PortaCruiser™ is a trademark of Aleratec, Inc.

---

Please record the following information to help expedite any warranty claim:

Model No. \_\_\_\_\_ Serial No. \_\_\_\_\_

Date Purchased \_\_\_\_\_

Place of Purchase \_\_\_\_\_

## Radio/TV Interference Statement

The equipment described in this guide emits radio frequency energy. If it is not installed in accordance with the manufacturer's instructions, it may cause interference with radio or television reception.

This equipment has been tested and found to comply with the limits for a Class B digital device, pursuant to Part 15 of the FCC Rules. These limits are designed to provide reasonable protection against harmful interference in a residential installation.

This equipment generates, uses, and can radiate radio frequency energy. If not installed and used in accordance with the instruction manual, this equipment may cause harmful interference to radio communications. However, there is no guarantee that interference will not occur in a particular installation. If this equipment does cause harmful interference to radio or television reception, which can be verified by turning the equipment off and on, the user is encouraged to try to correct the interference by one or more of the following measures:

- Reorient or relocate the receiving antenna.
- Increase the separation between the equipment and the receiver.
- Connect the equipment to an electrical outlet on a circuit that is different from the circuit to which the receiver is connected.
- Consult your dealer or an experienced radio/TV technician for help.

This equipment has been certified to comply with the limits for a Class B computing device, pursuant to FCC Rules. In order to maintain compliance with FCC regulations, shielded cables must be used with this equipment. Operation with non-approved equipment or unshielded cables is likely to result in interference to radio and TV reception. The user is cautioned that changes and/or modifications made to this equipment, without the approval of manufacturer, could void the user's authority to operate this equipment.

## Safety Regulations

### **WARNING**

To prevent fire or shock hazard, do not expose the unit to rain or moisture.

To avoid electrical shock, do not open the housing. Refer servicing to authorized personnel only.

# Table of Contents

<b>Introduction.....</b>	<b>1</b>
Product Features.....	1
Key Items.....	2
HDD PortaCruiser Display Panel and Buttons.....	3
<b>Precautions.....</b>	<b>4</b>
Installation.....	4
Choose a Good Location.....	4
Operation.....	4
Transportation.....	4
<b>Overview.....</b>	<b>5</b>
Power Up Sequence.....	5
Understanding RAID.....	6
RAID 0 (Striping).....	6
RAID 1 (Mirroring).....	6
JBOD (Just a Bunch of Disks or Spanning).....	6
Duplicator Main Menu.....	7
Duplicator Subfunctions.....	8
Dual Disk RAID (USB) Mode Main Menu.....	10
Normal Mode.....	10
JBOD Mode.....	10
RAID0 Mode.....	11
RAID1 Mode.....	11
<b>Using the HDD PortaCruiser.....</b>	<b>12</b>
Loading the Hard Drives.....	12
IDE Drives.....	12
SATA Drives.....	12
Removing Hard Drives.....	13
Duplicator Mode.....	14
Main Menu: Copy HDD.....	14
Main Menu: Compare HDD.....	15
Main Menu: PreScan Source.....	16
Main Menu: ReScan Bus.....	17
Main Menu: Source HDD Size.....	18
Main Menu: USB RAID Mode.....	19
Duplicator Mode.....	20
Setup Menu.....	20
Setup Menu: 6-01 Language.....	21
Setup Menu: 6-02 DMA Mode.....	22
Setup Menu: 6-03 Copy Size.....	23
Setup Menu: 6-04 Startup Menu.....	24
Setup Menu: 6-05 Auto Compare.....	25
Setup Menu: 6-06 Copy with Detect.....	26
Setup Menu: 6-07 Button Sound.....	27
Setup Menu: 6-08 Device Info.....	28
Setup Menu: 6-09 System Info.....	29

# Table of Contents

<b>Using the HDD PortaCruiser .....</b>	<b>30</b>
Duplicator Mode .....	30
Advanced Setup Menu .....	30
Advanced Setup Menu: 8-01 ReScan Bus Delay .....	31
Advanced Setup Menu: 8-02 Read Error Skip .....	32
Advanced Setup Menu: 8-03 Quick Erase HDD .....	33
Advanced Setup Menu: 8-04 H/W Diagnostic .....	34
Advanced Setup Menu: 8-05 Load Default .....	35
Advanced Setup Menu: 8-06 Link Option .....	36
Advanced Setup Menu: 8-07 USB Auto-Link .....	37
Advanced Setup Menu: 8-08 Copy HPA .....	38
Dual Disk RAID Controller (USB) Mode .....	39
Main Menu: Duplicator Mode Option .....	39
Main Menu: Information Option .....	40
Main Menu: Change RAID Mode Option .....	41
Dual Disk RAID Controller (USB) Mode – Normal Only .....	45
Main Menu: D1 Drive Select Mode Option .....	45
D2 Drive Select Mode Option .....	45
Dual Disk RAID Controller (USB) Mode – JBOD Only .....	46
Main Menu: Initial JBOD Option .....	46
Dual Disk RAID Controller (USB) Mode – RAID0 Only .....	47
Main Menu: Initial RAID0 Option .....	47
Dual Disk RAID Controller (USB) Mode – RAID1 Only .....	48
Main Menu: Initial RAID1 Option .....	48
<b>Specifications .....</b>	<b>49</b>
<b>Troubleshooting .....</b>	<b>49</b>
<b>Technical Support .....</b>	<b>50</b>
<b>Service and Support.....</b>	<b>51</b>
<b>Technical Support FAX Back Form.....</b>	<b>54</b>

## Introduction

Thank you for purchasing the HDD PortaCruiser. Please read this User Guide thoroughly before using this product.

### Product Features

The HDD PortaCruiser is a Hard Disk Drive Duplicator and Dual Disk RAID Controller.

- Duplicator Features
  - 1 to 1 SATA/IDE to SATA/IDE HDD duplicator
  - Stand alone, no computer needed
  - Complete cloning of partitions, boot sectors, and unallocated sectors
  - LCD display shows full menu items and progress
  - Supports SATA-to-SATA, SATA-to-IDE, IDE-to-SATA and IDE-to-IDE duplication
- Dual Disk RAID Controller Features
  - RAID 0 mode (Striping)
  - RAID 1 mode (Mirroring)
  - JBOD (Spanning mode) – combines two hard disk drives into one virtual drive
  - Normal Mode – access your dual drives separately

**NOTE:** In either mode, you must reset the unit when attaching/removing hard drives so that the system can re-scan the drives.

# Introduction

## Key Items

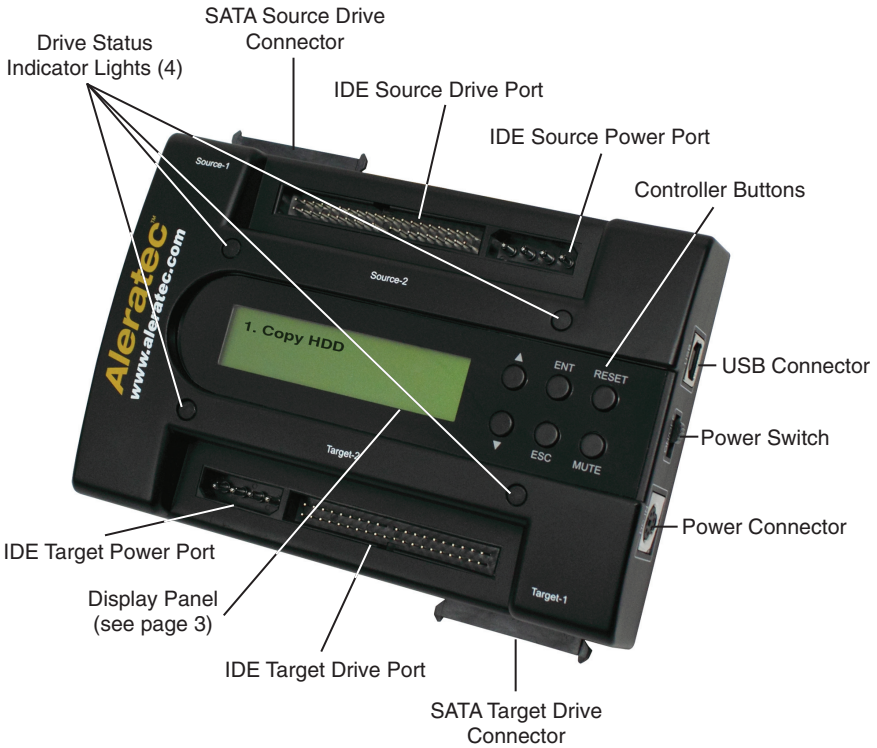



## Introduction

### HDD PortaCruiser Display Panel and Buttons

(Actual display may vary from illustration)

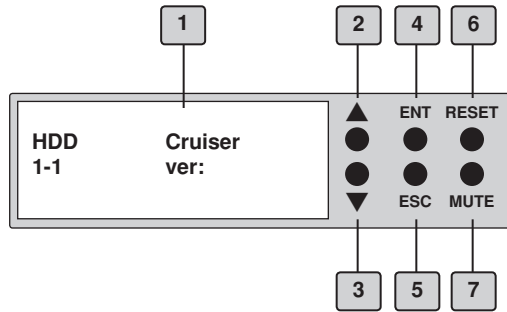

1. LCD display shows all functions and messages
2. **UP** arrow is used to scroll backward through functions or menus
3. **DOWN** arrow is used to scroll forward through functions or menus
4. **ENT** button is used to execute a selected function, or enter a menu
5. **ESC** button is used to cancel a selected function, or exit a menu
6. **RESET** button is used to restart the unit
7. **MUTE** button is used to mute audible alarms

## Precautions

Before installing your HDD PortaCruiser, please read the following.

### Installation

Avoid placing the HDD PortaCruiser in a location subject to:

- High humidity
- High temperature
- Excessive dust
- Mechanical vibration
- Direct sunlight
- Electromagnetic radiation

### Choose a Good Location

1. Allow adequate clearance for moving parts.
2. Do not place near heat sources such as radiators or air ducts, or in a place subject to direct sunlight, excessive dust, mechanical vibration or shock.
3. Disconnect the AC adapter from the outlet if the product is not used for an extended period of time.
4. Proper care will help assure maximum product life. Improper operating environment and misuse may void the warranty.

### Operation

Do not move the HDD PortaCruiser during operation. This may cause a malfunction or other undesirable results.

Avoid exposing the unit to sudden changes in temperature as condensation may form inside the HDD PortaCruiser. Should the surrounding temperature suddenly rise while the HDD PortaCruiser is on, wait at least one hour before turning off the power. Operating the duplicator immediately after a sudden increase in temperature may result in a malfunction.

### Transportation

Keep the original packing materials for future moving or shipping of the HDD PortaCruiser.

# Overview

## Power Up Sequence

During the normal power-up sequence of the HDD PortaCruiser, the following information will be displayed.

- Figure 1 shows the firmware version

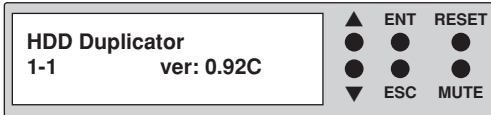

- Figure 2 shows the memory initialization

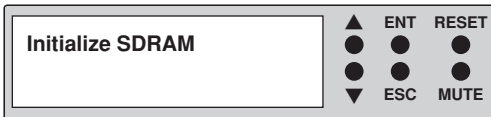

- Figure 3 shows the scanning of the drives

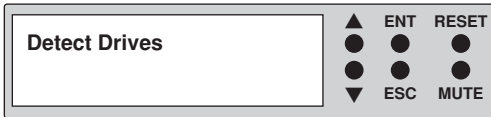

- Figure 4 shows the number of drives loaded.

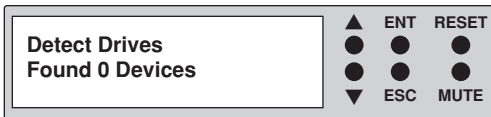

- Figure 5 shows the first function. The HDD PortaCruiser will initialize in either Duplicator Mode or Dual Disk RAID (USB) Mode depending on its last state.

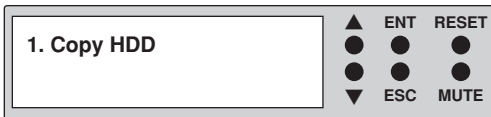

Duplicator Mode

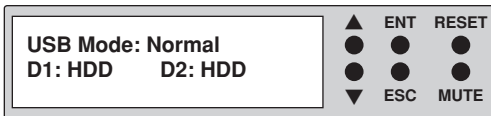

USB Mode

## Overview

### Understanding RAID

RAID (Redundant Array of Independent Disks) is a system composed of many hard drives; that is, multiple physical drives form a single virtual drive to be recognized by the system. Different RAID modes have different advantages and disadvantages.

#### RAID 0 (Striping)

RAID 0 must be composed of a pair of hard drives at least. When data is written into the whole hard drive, it will be equally striped and written into each hard drive of the array. Thus the access speed becomes quicker. The effect of RAID 0 is to proportion the data to a number of hard drives. More hard drives mean more read/write heads, and therefore higher speed. Though RAID 0 is quick in read/write speed, it has no data redundancy, and accordingly has no fault tolerance. It is suggested to compose RAID 0 with hard drives of the same capacity. Because the capacity of striped disk array is the multiplication of the smallest hard drive capacity with the number of hard drives. For example, a 100GB hard drive and a 120GB hard drive unite into RAID 0. The total capacity is 200GB (100GB×2).

#### RAID 1 (Mirroring)

RAID 1 must be composed of hard drives in even numbers. The RAID controller will divide the hard drives into a pair, and write data simultaneously into the two hard drives. The two hard drives contain the same data. When one hard drive's data are damaged, you can replace the failed hard drive, and the RAID controller will restore the data by the backup on the other hard drive. RAID 1 provides fault tolerance. It is suggested to compose RAID 1 with hard drives of the same capacity. Because the capacity of mirrored disk array is that of the smallest hard drive. For example, a 100GB hard drive and a 120GB one unite into RAID 1. The total capacity is 100GB.









#### JBOD (Just a Bunch of Disks or Spanning)

JBOD is not a real RAID setting. It simply combines a bunch of disks into a single virtual drive. It doesn't have the functions of quick read/write speed and error tolerance. However, compared with RAID 0, JBOD doesn't waste any hard drive capacity. Its capacity is the total of all hard drive capacities. For example, set a 100GB hard drive and a 120GB one as JBOD. The total capacity is 220GB.

# Overview

## Duplicator Main Menu

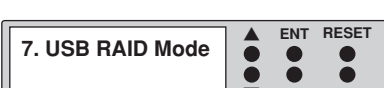
In Duplicator mode, there are eight main menu items that can be seen in the HDD PortaCruiser Copy Controller Display Panel. These are:

1. 
2. 
3. 
4. 
5. 
6. 
7. 
8. 

**Note:** The Advanced Setup function is a hidden menu. To access this menu, press **ESC** for 3 seconds. After you have completed any desired adjustments, press **ESC** to exit Advanced Setup.

# Overview

## Duplicator Subfunctions

The “Setup” menu has eight (8) subfunctions. These are:

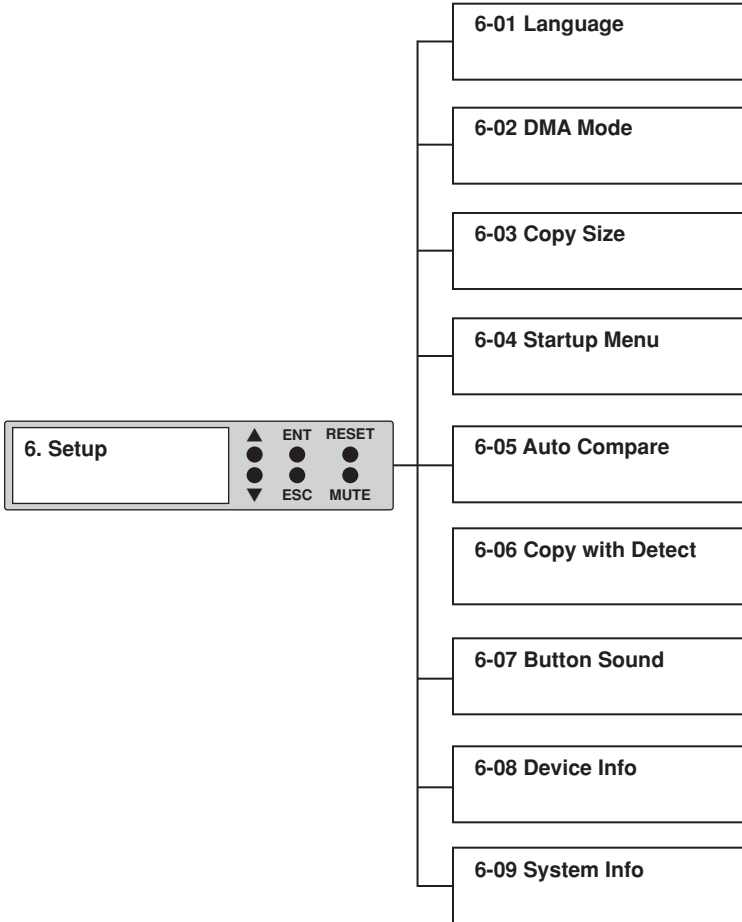

# Overview

The Duplicator “Advanced Setup” menu has eight (8) subfunctions. These are:

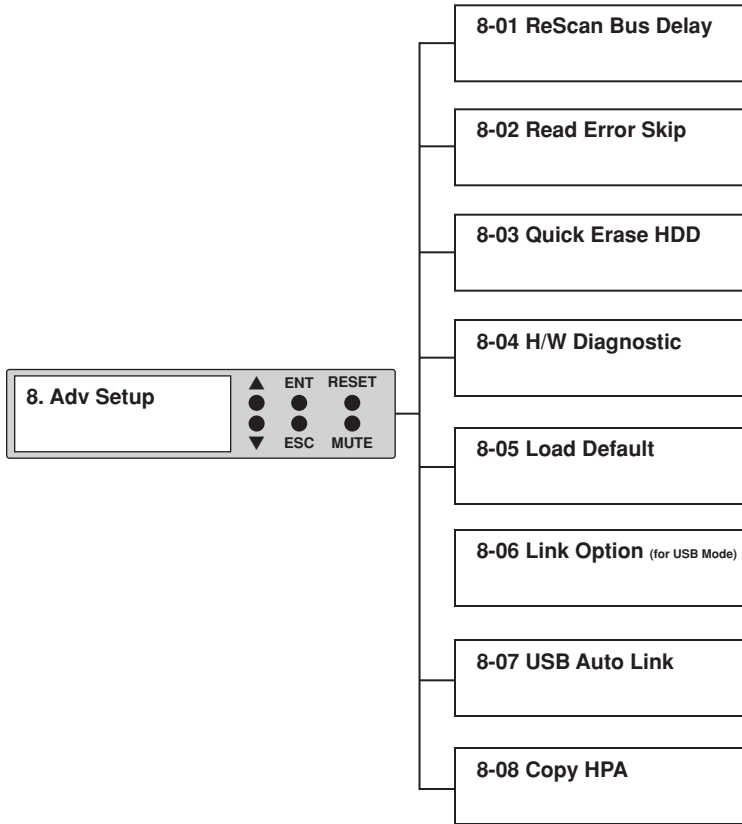

# Overview

## Dual Disk RAID (USB) Mode Main Menu

In USB mode, the options seen in the HDD PortaCruiser Display Panel depend on the RAID mode of the system. These are:

### Normal Mode

1. 

1. Duplicator Mode	▲	ENT	RESET
	●	●	●
	●	●	●
	▼	ESC	MUTE
2. 

2. Information	▲	ENT	RESET
	●	●	●
	●	●	●
	▼	ESC	MUTE
3. 

3. Change RAID Mode	▲	ENT	RESET
	●	●	●
	●	●	●
	▼	ESC	MUTE
4. 

4. D1 Drive Select	▲	ENT	RESET
	●	●	●
	●	●	●
	▼	ESC	MUTE
5. 

5. D2 Drive Select	▲	ENT	RESET
	●	●	●
	●	●	●
	▼	ESC	MUTE

### JBOD Mode

1. 

1. Duplicator Mode	▲	ENT	RESET
	●	●	●
	●	●	●
	▼	ESC	MUTE
2. 

2. Information	▲	ENT	RESET
	●	●	●
	●	●	●
	▼	ESC	MUTE
3. 

3. Change RAID Mode	▲	ENT	RESET
	●	●	●
	●	●	●
	▼	ESC	MUTE
4. 

4. Initial JBOD	▲	ENT	RESET
	●	●	●
	●	●	●
	▼	ESC	MUTE



# Overview

## RAID0 Mode

1. 

1. Duplicator Mode	▲	ENT	RESET
	●	●	●
	●	ESC	MUTE
	▼		
2. 

2. Information	▲	ENT	RESET
	●	●	●
	●	ESC	MUTE
	▼		
3. 

3. Change RAID Mode	▲	ENT	RESET
	●	●	●
	●	ESC	MUTE
	▼		
4. 

4. Initial RAID0	▲	ENT	RESET
	●	●	●
	●	ESC	MUTE
	▼		

## RAID1 Mode

1. 

1. Duplicator Mode	▲	ENT	RESET
	●	●	●
	●	ESC	MUTE
	▼		
2. 

2. Information	▲	ENT	RESET
	●	●	●
	●	ESC	MUTE
	▼		
3. 

3. Change RAID Mode	▲	ENT	RESET
	●	●	●
	●	ESC	MUTE
	▼		
4. 

4. Initial RAID1	▲	ENT	RESET
	●	●	●
	●	ESC	MUTE
	▼		

# Using the HDD PortaCruiser

## Loading the Hard Drives

### IDE Drives

1. Use an IDE cable (not included) to connect the source/target hard drive's IDE port to the HDD PortaCruiser's Source/Target IDE port.
2. Use an IDE cable (not included) to connect the source/target hard drive's power port to the HDD PortaCruiser's Source/Target port.



### SATA Drives

1. Position the HDD PortaCruiser on a flat surface with enough area around it to place the source/target hard drive.
2. Align the source/target hard drive's SATA port with the HDD PortaCruiser's SATA connector.
3. Slide the source/target hard drive against the HDD PortaCruiser so that the SATA connection is made.

**Note:** If you are duplicating, the hard disk drive you are copying goes on the side labeled "Source", and the hard disk drive you are copying to goes on the side labeled "Target".

**Note:** When both the IDE and SATA connectors on the Target (or Source) side are connected to hard drives, the HDD PortaCruiser will only recognize the SATA drive.



## Using the HDD PortaCruiser

### Removing Hard Drives

1. Remove the IDE and power cables (for IDE drives) or slide the hard drive away from the HDD PortaCruiser unit (for SATA drives).

**Note:** Do not attempt to remove the hard drive if the drive activity LED is on or the unit is in the middle of a process.

# Using the HDD PortaCruiser

## Duplicator Mode

Main Menu: Copy HDD

The “Copy HDD” function performs an actual copy from the source HDD to the target HDD. The target HDD must be at least as large as the source. The HDD PortaCruiser will copy every block of capacity on the source HDD.

1. Load the source HDD and the target HDD into the HDD PortaCruiser. The system will auto-detect the hard drives. After the drives have been detected, a screen similar to the one below will be displayed.

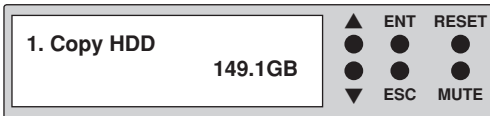

**Note:** Before copying be sure that the capacity of the target HDD is equal to or larger than the source hard drive.

2. Press ENT to start copying. The system will auto-detect the hard drives. The following information will be displayed.



3. During the copy process the HDD PortaCruiser will display progress information.

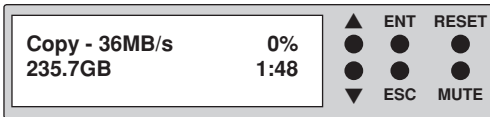

The amount of data remaining to be transferred (shown in gigabytes), and time will be displayed in decreasing increments as the percentage of completion increases.

**Note:** The copying speed, capacity and duration may vary from one source hard drive to another.

4. Once duplication is complete, a job status screen will be displayed.



# Using the HDD PortaCruiser

## Duplicator Mode

Main Menu: Compare HDD

The “Compare HDD” function performs a comparison of data from the source hard drive to the data on the target hard drive.

1. With the source and target HDDs loaded use the arrow buttons (▼or▲) to select “Compare HDD”. The following screen will be displayed.



2. Press ENT to begin the comparison. The system will auto-detect the hard drives.

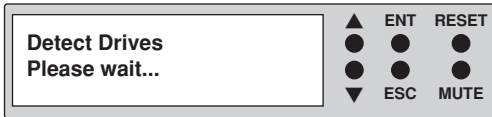

During the compare process, the HDD PortaCruiser will display progress information.

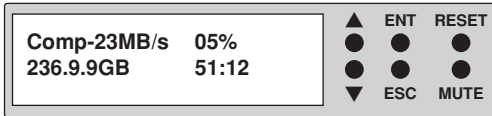

3. When the comparison is completed, a job status screen will be displayed.



# Using the HDD PortaCruiser

## Duplicator Mode

Main Menu: PreScan Source

The “PreScan Source” scans the source hard drive to determine if it can be read correctly.

1. With the source HDD loaded, use the arrow buttons (▼ or ▲) to select “PreScan Source”. The following screen will be displayed.

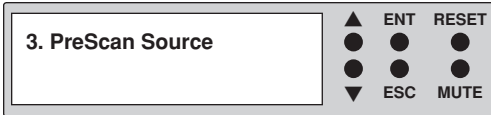

2. Press **ENT** to begin the scan. The system will auto-detect the hard drives.



During the PreScan process, the HDD PortaCruiser will display progress information.

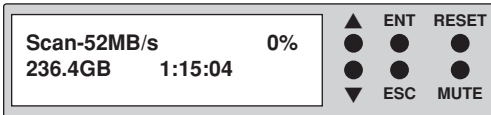

3. When the PreScan is complete, a job status screen will be displayed.



# Using the HDD PortaCruiser

## Duplicator Mode

Main Menu: ReScan Bus

The “ReScan Bus” function causes the HDD PortaCruiser to redetect connected hard drives. This can be used when you change drives without restarting the system.

1. Use the arrow buttons (▼ or ▲) to select “ReScan BUS”. The following screen will be displayed.



2. Press **ENT** to select. The system will prompt you to confirm that you wish to proceed.

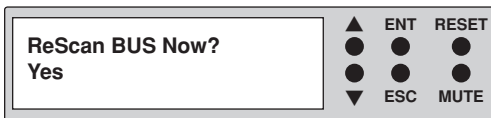

3. Press **ENT** to begin the rescan, during which the following screen will be displayed.



**Note:** The order of scanning is Source SATA, Source IDE, Target SATA, Target IDE.

4. When the rescan is complete, the following screen will be displayed.

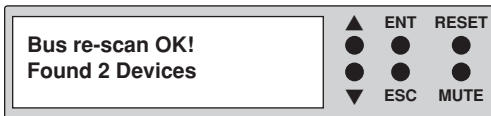

# Using the HDD PortaCruiser

## Duplicator Mode

Main Menu: Source HDD Size

The “Source Size” function is used to display the capacity of the source hard drive.

1. With the source HDD loaded, use the arrow buttons (▼ or ▲) to select “Source size”. The following screen will be displayed.

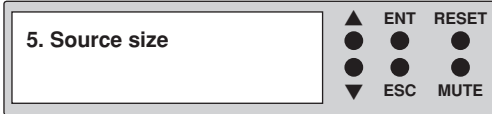

2. Press **ENT** to display the capacity of the source hard drive.

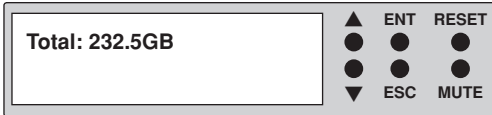



# Using the HDD PortaCruiser

## Duplicator Mode

Main Menu: USB RAID Mode

This function allows you to switch to the Dual Disk RAID Controller mode.

1. Use the arrow buttons (▼ or ▲) to select “USB RAID Mode”. The following screen will be displayed.



2. Press **ENT** to select. The system will prompt you to confirm that you wish to change modes.



3. Use the arrow buttons (▼ or ▲) to select “YES” and press **ENT** to select. The following screen will be displayed showing your connected drives.

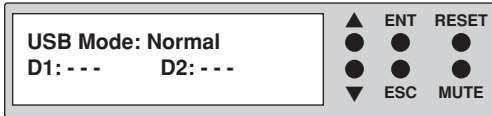

# Using the HDD PortaCruiser

## Duplicator Mode

### Setup Menu

The “Setup” menu contains configuration options for the HDD PortaCruiser. It is suggested to use the factory defaults for optimum performance.

1. Use the arrow buttons (▼ or ▲) to select “Setup”. The following screen will be displayed.



**Note:** After changing any of the configuration options, you must press **ENT** to accept the change.

# Using the HDD PortaCruiser

## Duplicator Mode

### Setup Menu: 6-01 Language

This option allows you to select the language that is used for the display.

1. Use the arrow buttons (▼ or ▲) select “Setup”. The following screen will be displayed.

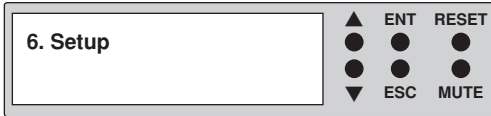

2. Press **ENT** and use the arrow buttons (▼▲) to scroll to “Language”. The following screen will be displayed.



3. Press **ENT** to display the current language selection (the default language is English).



4. Use the arrow buttons (▼▲) to toggle through the available options. Once you change a configuration option, remember to press **ENT** to save it.

# Using the HDD PortaCruiser

## Duplicator Mode

Setup Menu: 6-02 DMA Mode

This function is used to specify the Ultra DMA mode.

1. Use the arrow buttons (▼ or ▲) select “Setup”. The following screen will be displayed.

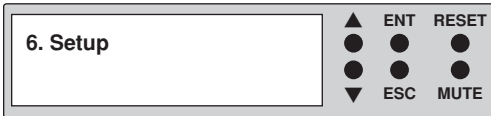

2. Press **ENT** and use the arrow buttons (▼▲) to scroll to “Copy Size”. The following screen will be displayed.



3. Press **ENT** to display the current configuration setting.



4. Use the arrow buttons (▼▲) to toggle through the available modes (1-4). Once you change a setting, remember to press **ENT** to save it.

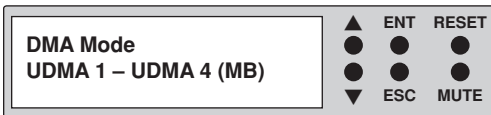

# Using the HDD PortaCruiser

## Duplicator Mode

### Setup Menu: 6-03 Copy Size

This function is used to specify the amount of source disk data to copy to the target drive.

1. Use the arrow buttons (▼ or ▲) select “Setup”. The following screen will be displayed.

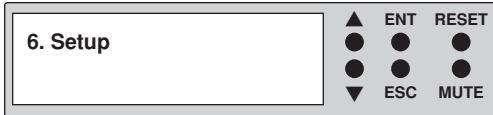

2. Press **ENT** and use the arrow buttons (▼▲) to scroll to “Copy Size”. The following screen will be displayed.



3. Press **ENT** to display the current configuration setting.



4. Use the arrow buttons (▼▲) to toggle through the available copy sizes (1%-100%). Once you change a setting, remember to press **ENT** to save it.

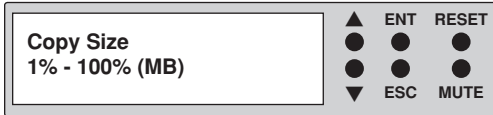

# Using the HDD PortaCruiser

## Duplicator Mode

### Setup Menu: 6-04 Startup Menu

This option lets you select any of the functions (except “Setup”) as the initial function that appears when the HDD PortaCruiser is powered on.

1. Use the arrow buttons (▼ or ▲) select “Setup”. The following screen will be displayed.

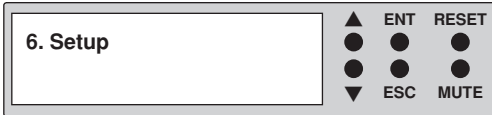

2. Press **ENT** and use the arrow buttons (▼▲) to scroll to “Startup Menu”. The following screen will be displayed.



3. Press **ENT** to display the current configuration setting. The default setting is “1. Copy HDD”.

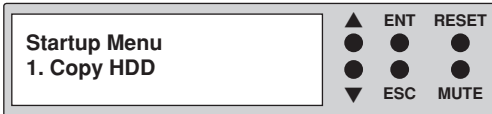

4. Use the arrow buttons (▼▲) to toggle through the available options. Once you change a setting, remember to press **ENT** to save it.

# Using the HDD PortaCruiser

## Duplicator Mode

### Setup Menu: 6-05 Auto Compare

This option allows you to choose whether or not to automatically compare the source and target hard drive after every copy operation.

1. Use the arrow buttons (▼ or ▲) select “Setup”. The following screen will be displayed.

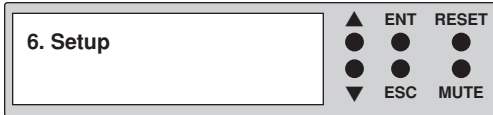

2. Press **ENT** and use the arrow buttons (▼▲) to scroll to “Auto Compare”. The following screen will be displayed.



3. Press **ENT** to display the current configuration setting. The default setting is “Off”.



4. Use the arrow buttons (▼▲) to modify the setting. After you change a setting, remember to press **ENT** to save it.

# Using the HDD PortaCruiser

## Duplicator Mode

### Setup Menu: 6-06 Copy with Detect

This option allows you to choose whether or not to automatically rescan for connected drives immediately before a copy operation.

1. Use the arrow buttons (**▼** or **▲**) select “Setup”. The following screen will be displayed.

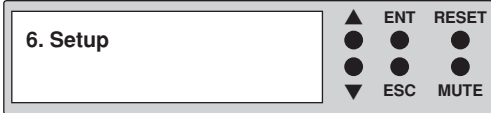

2. Press **ENT** and use the arrow buttons (**▼▲**) to scroll to “Copy with Detect”. The following screen will be displayed.



3. Press **ENT** to display the current configuration setting. The default setting is “Off”.

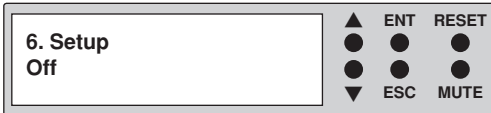

4. Use the arrow buttons (**▼▲**) to modify the setting. After you change a setting, remember to press **ENT** to save it.



# Using the HDD PortaCruiser

## Duplicator Mode

### Setup Menu: 6-07 Button Sound

This option allows you to enable or disable the beeping sound heard when you press a button.

1. Use the arrow buttons (▼ or ▲) select “Setup”. The following screen will be displayed.



2. Press **ENT** and use the arrow buttons (▼▲) to scroll to “Button Sound”. The following screen will be displayed.



3. Press **ENT** to display the current configuration setting. The default is “On”.



4. Use the arrow buttons (▼▲) to toggle through the available options. Once you change a default, remember to press **ENT** to save it.

# Using the HDD PortaCruiser

## Duplicator Mode

Setup Menu: 6-08 Device Info

This option displays information about any hard drives connected to the HDD PortaCruiser.

1. Use the arrow buttons (▼ or ▲) to scroll to “Setup”. The following screen will be displayed.

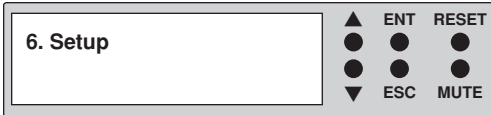

2. Press **ENT** and use the arrow buttons (▼▲) to scroll to “Device Info”. The following screen will be displayed.



3. Press **ENT** to display information about the first device.

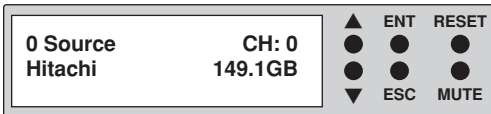

4. Use the arrow buttons (▼ or ▲) to show information about any additional hard drive that is connected. The following screen will be displayed.

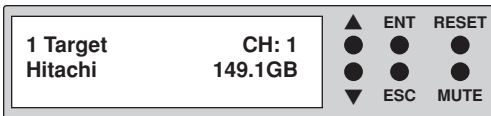

# Using the HDD PortaCruiser

## Duplicator Mode

Setup Menu: 6-09 System Info

This function displays information about the HDD PortaCruiser, including the current firmware version.

1. Use the arrow buttons (▼ or ▲) to select “Setup”. The following screen will be displayed.

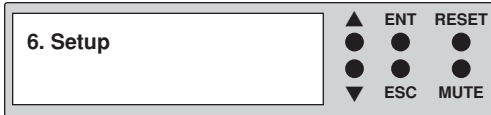

2. After selecting “Setup” use the arrow keys (▼▲) to toggle between the subfunctions. Press **ENT** to select. “System Info”. The following information will be displayed.

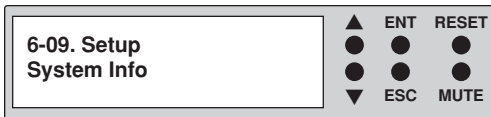

3. Press **ENT** to display system information.



# Using the HDD PortaCruiser

## Duplicator Mode

### Advanced Setup Menu

The “Adv Setup” menu contains additional configuration options for the HDD PortaCruiser.

1. Press and hold the **ESC** button for 3 seconds to enter Adv Setup. The following screen will be displayed.

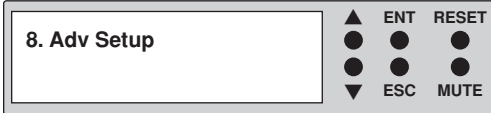

**Note:** After changing any of the configuration options, you must press **ENT** to accept the change. Once all changes are complete, press **ESC** to exit the Adv Setup menu. The following screen will be displayed.

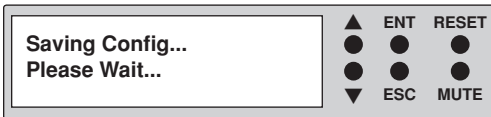

2. When the configuration changes have been saved, the following screen will be shown.



# Using the HDD PortaCruiser

## Duplicator Mode

### Advanced Setup Menu: 8-01 ReScan Bus Delay

This function is used to set the time interval between the system's re-scans of all connected HDD devices.

1. Press and hold **ESC** for about 3 seconds to access the "Adv Setup" menu. The following screen will be displayed.

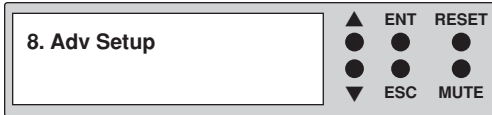

2. Use the arrow buttons (▼ or ▲) to scroll to "ReScan Bus Delay". The following screen will be displayed.

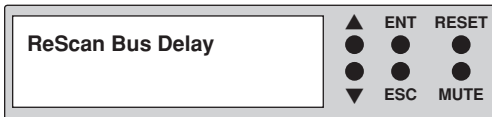

3. Press **ENT** to display the current configuration setting. Use the arrow buttons (▼ or ▲) to choose different time settings (1-60 seconds). After changing a setting, remember to press **ENT** to save it.

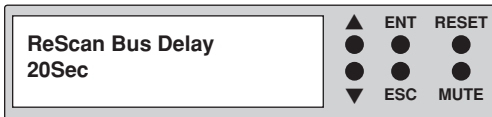

# Using the HDD PortaCruiser

## Duplicator Mode

### Advanced Setup Menu: 8-02 Read Error Skip

This function can be enabled to ignore any error that occurs during copying. By default, the HDD PortaCruiser will halt the copy operation when it encounters an unreadable area of the source hard disk and display an error. Enabling this option will ignore any bad sectors on the source hard drive by skipping over them.

**Warning:** Setting this function to “On” may result in corrupt data on copied hard drives.

1. Press and hold **ESC** for about 3 seconds to access the “Adv Setup” menu. The following screen will be displayed.

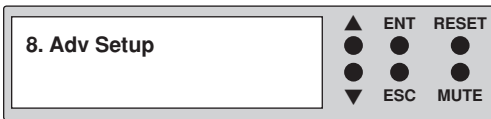

2. Use the arrow buttons (**▼** or **▲**) to scroll to “Read Error Skip”. The following screen will be displayed.



3. Press **ENT** to display the current configuration setting. The default setting is “Off”.

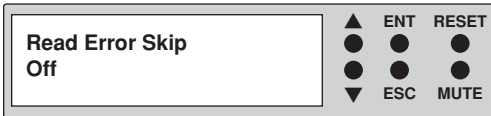

4. Press the arrow buttons (**▼** or **▲**) to toggle the option “On” or “Off”. After changing a setting, remember to press **ENT** to save it.

# Using the HDD PortaCruiser

## Duplicator Mode

### Advanced Setup Menu: 8-03 Quick Erase HDD

This function is used to erase the data of a hard drive quickly.

**Warning:** Backup any important data before using this function.

1. Press and hold **ESC** for about three seconds to access the “Adv Setup” menu. The following screen will be displayed.

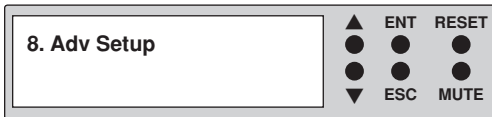

2. Use the arrow buttons (▼ or ▲) to select “Quick Erase HDD”. The following screen will be displayed.



3. Press **ENT**, and you will be prompted whether you wish to proceed. Use the arrow keys (▼▲) to select “Yes” or “No”. The following screen will be displayed.

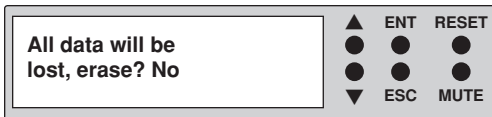

4. Select “Yes” and press **ENT**. The Quick Erase will begin. Once complete the following information will be displayed.



# Using the HDD PortaCruiser

## Duplicator Mode

### Advanced Setup Menu: 8-04 H/W Diagnostic

This function is used to test various components of the HDD PortaCruiser.

1. Press and hold **ESC** for about three seconds to access the “Adv Setup” menu. The following screen will be displayed.

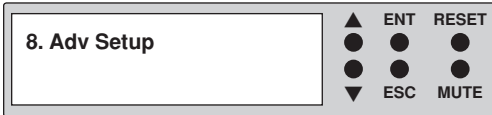

2. Use the arrow buttons (**▼** or **▲**) to select “H/W Diagnostic”. The following screen will be displayed.

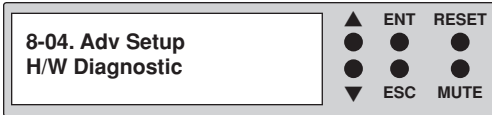

3. Press **ENT** to begin the diagnostic tests. The following tests will be performed: Button Test, Self-Test of SDRAM, Hardware Connection Test, and Flash Test. Follow the on screen prompts to complete each test. All test results will be shown in the display panel.

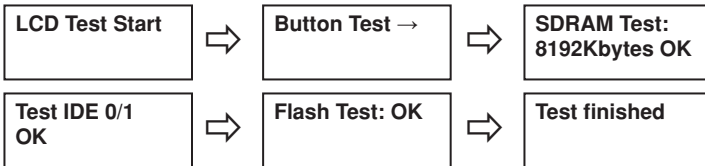

**Note:** The Button Test allows you to push the buttons and confirm that they are working properly. A button press will indicate on the LCD screen. **DO NOT** press the Reset button during this test as it will reset the unit. Press and hold the **ESC** button to exit this portion of the test.

4. When all tests are complete the following information will be displayed.

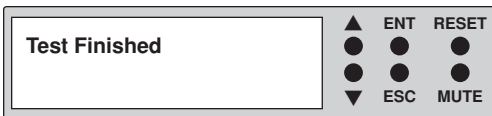



# Using the HDD PortaCruiser

## Duplicator Mode

### Advanced Setup Menu: 8-05 Load Default

This function is used to restore all factory settings of the HDD PortaCruiser back to their original defaults.

1. Press and hold **ESC** for about three seconds to access the “Adv Setup” menu. The following screen will be displayed.

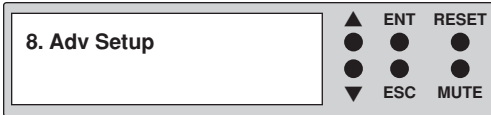

2. Use the arrow buttons (**▼** or **▲**) to select “Load Default”. The following screen will be displayed.

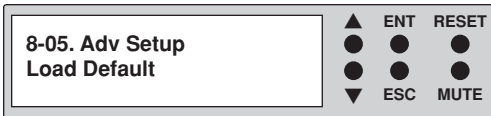

3. Press **ENT** to proceed to the following screen:



Press **ENT** to confirm loading defaults, or press **ESC** to cancel.

4. When all settings are restored to their original defaults the following information will be displayed.



# Using the HDD PortaCruiser

## Duplicator Mode

### Advanced Setup Menu: 8-06 Link Option

This function is used to decide if “7.USB RAID Mode” will be displayed in the display panel.

1. Press and hold **ESC** for about three seconds to access the “Adv Setup” menu. The following screen will be displayed.



2. Use the arrow buttons (**▼** or **▲**) to select “Link Option”. The following screen will be displayed.



3. Press **ENT** to display the available options. The default is “Menu ON” which specifies for “7.USB RAID Mode” to appear in the main menu.



If set to “OFF”, “7.USB RAID Mode” will not appear in the main menu. After changing a setting, remember to press **ENT** to save it.

# Using the HDD PortaCruiser

## Duplicator Mode

### Advanced Setup Menu: 8-07 USB Auto-Link

This function sets the HDD PortaCruiser to immediately enter Dual Disk RAID Controller (USB) mode on startup. This allows direct control of the unit from a PC.

1. Press and hold **ESC** for about three seconds to access the “Adv Setup” menu. The following screen will be displayed.

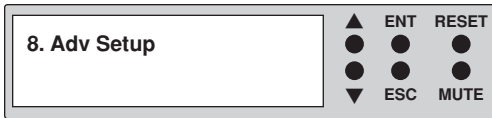

2. Use the arrow buttons (**▼** or **▲**) to select “USB Auto-Link”. The following screen will be displayed.

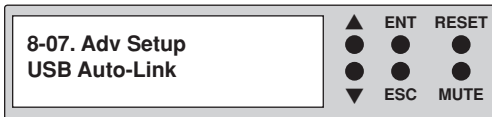

3. Press **ENT** to display the available options. The default is “OFF”.



4. Use the arrow buttons (**▼** **▲**) to toggle the option “ON” or “OFF”. If set to “ON” the unit will immediately enter USB mode on startup. After changing a setting, remember to press **ENT** to save it.



# Using the HDD PortaCruiser

## Duplicator Mode

### Advanced Setup Menu: 8-08 Copy HPA

If the source hard disk contains a Host Protected Area (HPA), this option allows you to choose whether or not to copy data within the HPA.

1. Press and hold **ESC** for about three seconds to access the “Adv Setup” menu. The following screen will be displayed.

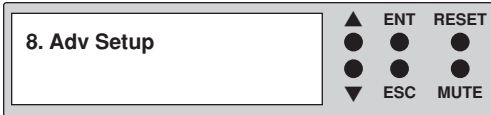

2. Use the arrow buttons (**▼** or **▲**) to select “Copy HPA”. The following information will be displayed.



3. Press **ENT** to display the current configuration setting. A screen similar to the following will be displayed.



4. Use the arrow buttons (**▼** or **▲**) to toggle the option “On” or “Off”. After changing a setting, remember to press **ENT** to save it.

**Note:** The HPA is a hidden data region defined in ATA/ATAPI-4. This area is not usually accessible to the operating system or software applications. The HDD PortaCruiser supports the copying of data from this hidden area.

# Using the HDD PortaCruiser

## Dual Disk RAID Controller (USB) Mode

Main Menu: Duplicator Mode Option

This function allows you to switch to the Duplicator mode.

1. Use the arrow buttons (▼ or ▲) to select “Duplicator Mode”. The following screen will be displayed.



2. Press **ENT** to select. The system will prompt you to confirm that you wish to change modes.

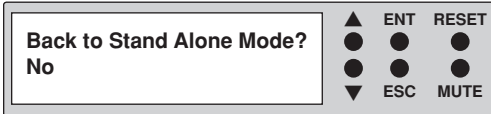

3. Use the arrow buttons (▼▲) to select “Yes” and press **ENT** to select. The following screen will be displayed. The unit is now back in Duplicator Mode.

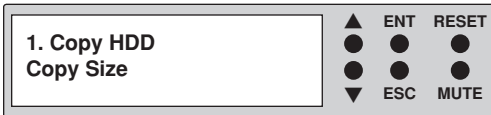

# Using the HDD PortaCruiser

## Dual Disk RAID Controller (USB) Mode

### Main Menu: Information Option

This function displays information about the HDD PortaCruiser and any attached hard drives.

1. Use the arrow buttons (▼ or ▲) to select “Information”. The following screen will be displayed.

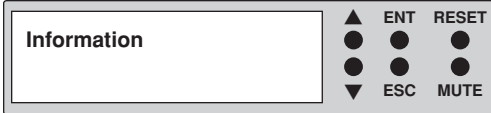

2. Press **ENT** to select. The system will prompt you to choose the desired device.



3. Use the arrow buttons (▼ or ▲) to select between System, Drive1 and Drive2 and press **ENT** to select.

For System information, USB Mode and firmware version will be displayed.

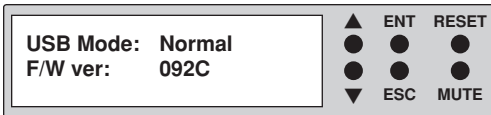

For Drive information, drive model information and capacity will be displayed.

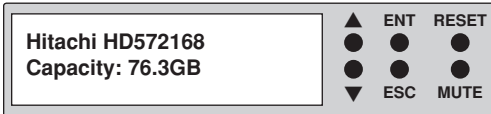

# Using the HDD PortaCruiser

## Dual Disk RAID Controller (USB) Mode

Main Menu: Change RAID Mode Option

This function allows you to choose the RAID mode for the Dual Disk RAID Controller.

1. Use the arrow buttons (▼ or ▲) to select “Change RAID Mode”. The following screen will be displayed.

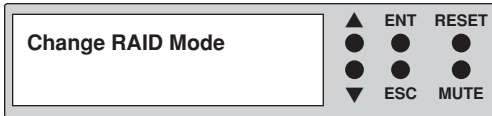

2. Press **ENT** to select. The system will prompt you to choose the desired mode.



3. Use the arrow buttons (▼▲) to select between Normal, JBOD, RAID0, and RAID1, and press **ENT** to select.

### Changing to Normal Mode

4. The system will prompt you to confirm that you wish to change modes.

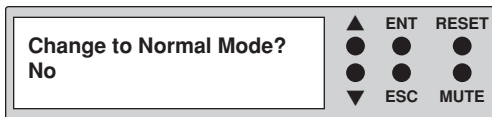

5. Use the arrow buttons (▼ or ▲) to select “Yes” and press **ENT** to select. The system will then prompt you to confirm that you understand data may be lost.

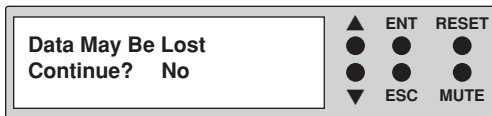

## Using the HDD PortaCruiser

### Dual Disk RAID Controller (USB) Mode

Main Menu: Change RAID Mode Option

#### Changing to Normal Mode - *continued*

- Use the arrow buttons (▼▲) to select “Yes” and press **ENT** to select. The new main screen will be shown which displays the new mode and capacity.



#### Changing to JBOD Mode

- The system will prompt you to confirm that you wish to change modes.

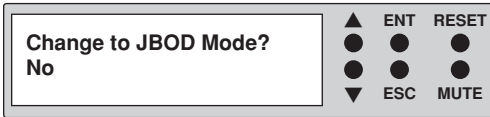

- Use the arrow buttons (▼or▲) to select “Yes” and press **ENT** to select. The system will then prompt you to confirm that you understand data may be lost.

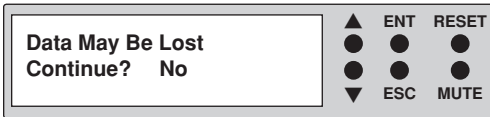

- Use the arrow buttons (▼▲) to select “Yes” and press **ENT** to select. The new main screen will be shown which displays the new mode and capacity.





## Using the HDD PortaCruiser

### Changing to RAID0 Mode

- The system will prompt you to confirm that you wish to change modes.

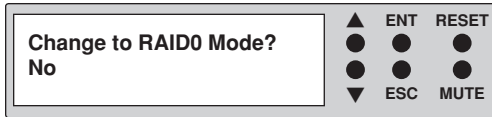

- Use the arrow buttons (▼ or ▲) to select "Yes" and press **ENT** to select. The system will then prompt you to confirm that you understand data may be lost.



- Use the arrow buttons (▼▲) to select "Yes" and press **ENT** to select. The new main screen will be shown which displays the new mode and capacity.

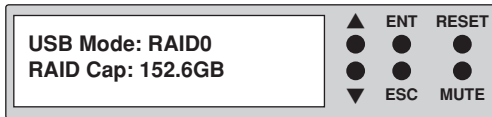

### Changing to RAID1 Mode

- The system will prompt you to confirm that you wish to change modes.

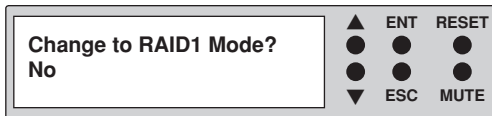

- Use the arrow buttons (▼▲) to select "Yes" and press **ENT** to select. The system will then prompt you to confirm that you understand data may be lost.

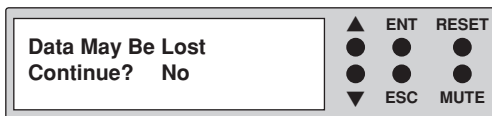

## Using the HDD PortaCruiser

### Dual Disk RAID Controller (USB) Mode

Main Menu: Change RAID Mode Option

#### Changing to RAID1 Mode - *continued*

- Use the arrow buttons (▼▲) to select “Yes” and press **ENT** to select. The system will then ask you whether or not you want to preserve the Source drive’s data.



- If you would like to keep the Source drive’s data, use the arrow buttons (▼▲) to select “Yes” and press **ENT** to select. The device will copy the source drive’s data to the target drive and a new main screen will be shown which displays the new mode and capacity.

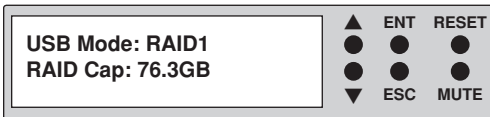

## Using the HDD PortaCruiser

### Dual Disk RAID Controller (USB) Mode – Normal Only

#### Main Menu: D1 Drive Select Mode Option

This function allows you to enable or disable the Source drive.

1. Use the arrow buttons (▼ or ▲) to select “D1 Drive Select”. The following screen will be displayed.

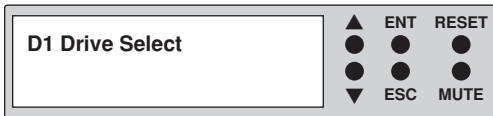

2. Press **ENT** to select. The system will prompt you to choose the desired mode.

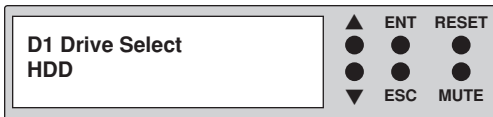

3. Use the arrow buttons (▼▲) to select between HDD and Disable and press **ENT** to select.

#### D2 Drive Select Mode Option

This function allows you to enable or disable the Target drive.

1. Use the arrow buttons (▼ or ▲) to select “D2 Drive Select”. The following screen will be displayed.



2. Press **ENT** to select. The system will prompt you to choose the desired mode.

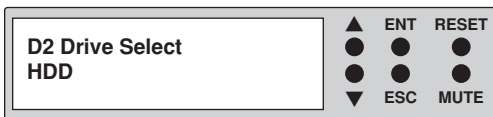

3. Use the arrow buttons (▼▲) to select between HDD and Disable and press **ENT** to select.

## Using the HDD PortaCruiser

### Dual Disk RAID Controller (USB) Mode – JBOD Only

Main Menu: Initial JBOD Option

This function allows you to initialize your disks for JBOD.

1. Use the arrow buttons (▼ or ▲) to select “Initial JBOD”. The following screen will be displayed.

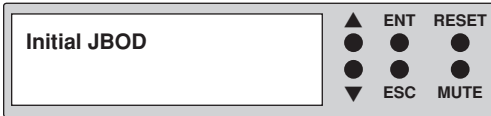

2. Press **ENT** to select. The system will then prompt you to confirm that you understand data may be lost.

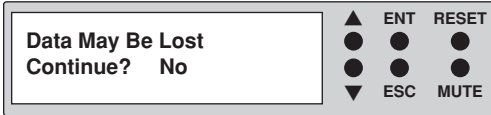

3. Use the arrow buttons (▼ or ▲) to select “Yes” and press **ENT** to select. The new main screen will be shown which displays the new mode and capacity.



## Using the HDD PortaCruiser

### Dual Disk RAID Controller (USB) Mode – RAID0 Only

Main Menu: Initial RAID0 Option

This function allows you to initialize your disks for RAID0.

1. Use the arrow buttons (▼ or ▲) to select “Initial RAID0”. The following screen will be displayed.



2. Press **ENT** to select. The system will then prompt you to confirm that you understand data may be lost.

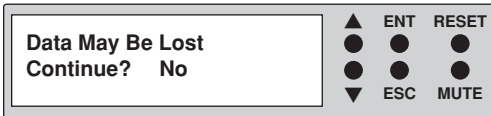

3. Use the arrow buttons (▼ or ▲) to select “Yes” and press **ENT** to select. The new main screen will be shown which displays the new mode and capacity.

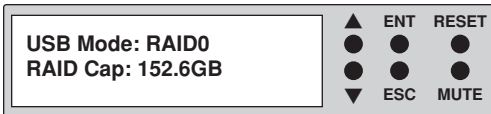

## Using the HDD PortaCruiser

### Dual Disk RAID Controller (USB) Mode – RAID1 Only

Main Menu: Initial RAID1 Option

This function allows you to initialize your disks for RAID1.

1. Use the arrow buttons (▼ or ▲) to select “Initial RAID1”. The following screen will be displayed.



2. Press **ENT** to select. The system will then prompt you to confirm that you understand data may be lost.



3. Use the arrow buttons (▼ or ▲) to select “Yes” and press **ENT** to select. The new main screen will be shown which displays the new mode and capacity.



## Specifications

Power Requirements	Voltage: 100-240V Current: 50-60Hz
Dimensions (depth x width x height)	D: 150mm W: 116mm H: 27mm (5.9" x 4.6" x 1.0")
Weight	235g (0.5 Lbs.)

**Note:** Specifications subject to change without notice.

## Troubleshooting

If your HDD PortaCruiser is not performing as expected, refer to the symptoms below, and follow the suggested corrective action.

Symptoms	Corrective Actions
LCD Display	If the LCD display does not display any message and the backlight is not lit after powering on the HDD PortaCruiser, check that the power cable is properly connected and that the ON/OFF switch is turned on.
Error Messages	While the system is performing an operation and the operation is manually terminated, an error message will be shown in the LCD display. This may lead to a failed operation and could cause the HDD PortaCruiser to stop responding. If this happens, power the unit off, wait about ten (10) seconds, and then reapply power.
Hard Disk	If the HDD PortaCruiser does not detect one of the hard disk drives, verify that the drive is properly connected.
Keypad Buttons	If pressing the keys on the front panel produces no response from the system, the HDD PortaCruiser may still be busy with the previous operation. If the system is idle, power the unit off, wait about ten (10) seconds, and then reapply power.
Startup/Shutdown	Do not power off the system while it is performing an operation. After a normal shutdown, wait about ten (10) seconds before reapplying power.

## Technical Support

After reading this User Guide, if you need additional assistance with this product, please contact Aleratec Technical Support. Our technical staff will be happy to assist you, but they may need your help to better assist you.

Contacting support without all the necessary information can be both time consuming and frustrating. Therefore, please try to have the following information ready before calling:

1. Part Number - the part number is located on the bottom of the HDD PortaCruiser.
2. Serial Number - the serial number is located on the back of the HDD PortaCruiser.
3. Troubles/symptoms - please provide enough information about the issue so our technical staff can accurately diagnose it.

## Technical Support Addresses and Phone Numbers

► By e-mail: **support@aleratec.com**

► By Telephone: **1-818-678-0484**

Technical Support Group can be reached 8:00 AM to 5:00 PM, Pacific Time, Monday through Friday, excluding U.S. holidays.

Please try to call from a phone near your Aleratec product.

► Access is available 24 hours a day, 365 days a year, via:

The World Wide Web at: **www.aleratec.com**

FAX at: **1-818-678-0483**



## Service and Support

### **Aleratec, Inc., Limited Warranty**

This Limited Warranty covers defects encountered in the course of normal use of this product and does not apply to damage from improper use, abuse, accidents, unauthorized service, or inadequate packaging when shipping the product to Aleratec, Inc.

Aleratec, Inc. provides the following limited warranty for this product only if the product was originally purchased for use, not re-sale, from Aleratec, Inc., an Aleratec, Inc. authorized dealer or distributor, or any other Aleratec, Inc. approved reseller for this product. This product is warranted to be free from defects in workmanship and material for a period of one year from the date of your original purchase.

If the product fails during normal and proper use within the warranty period, Aleratec, Inc. will, at its option, repair or replace the product at no cost (except shipping and insurance). This limited warranty does not include service to repair damage from improper installation, accident, disaster, misuse, abuse, or modifications to the subsystem, or by any other causes unrelated to defective materials or workmanship.

## Service and Support

### Please Note:

This Warranty is valid only within the United States and Puerto Rico, and applies only to products that are new and unopened on the date of purchase. For areas outside the United States and Puerto Rico, contact the authorized dealer from whom you purchased this product to determine which warranty, if any, applies.

THIS LIMITED WARRANTY CONSTITUTES YOUR SOLE AND EXCLUSIVE REMEDY, AND THE SOLE AND EXCLUSIVE LIABILITY OF ALERATEC, INC., AND IS IN LIEU OF ALL OTHER WARRANTIES, EXPRESSED OR IMPLIED, INCLUDING, BUT NOT LIMITED TO ANY IMPLIED WARRANTY OF MERCHANTABILITY OF ITEMS FOR A PARTICULAR PURPOSE.

Your sole remedy shall be repair or replacement, with new or refurbished components, as provided in this Limited Warranty. Aleratec, Inc. shall not be liable for any direct, indirect, special incidental products or consequential damages, including, but not limited to, any loss of data or loss of profits or business, regardless of the form of action or theory of liability resulting from any defect in, or use of, this product (even if Aleratec, Inc. has been advised of the possibility of such damages).

In any event, the liability of Aleratec, Inc. under this Limited Warranty, for damages to you or any third party, regardless of the form of action or theory of liability, shall not exceed the purchase price you paid for this product.

Some states do not allow limitations of the disclaimer of implied warranties, the period an implied warranty lasts, or the exclusion or limitation of incidental or consequential damages, so the exclusions and limitations stipulated in this Limited Warranty may not apply to you. This Limited Warranty gives you specific legal rights, and you may have other rights which vary from state to state.

## Service and Support

### To Obtain Warranty Service:

You must ship your subsystem to the authorized dealer where your subsystem was purchased within the one year warranty period and no later than thirty days after discovery of claimed defect, whichever occurs first. In either case, you must provide proof of original purchase before any warranty service can be performed. Products and parts provided as a result of warranty service may be other than new but will be in good working order and become your property at the time of exchange. At the same time, the exchanged products or parts become the property of Aleratec, Inc.

When shipping the subsystem for service, you agree to insure the Duplicator, to prepay shipping charges, and to use the original shipping container or equivalent. Any service outside the scope of this limited warranty shall be at Aleratec, Inc.'s or its Authorized Service Provider's rates and terms then in effect.

This warranty gives you specific legal rights; you may also have other rights which vary from state to state.

# Technical Support FAX Back Form

**Aleratec, Inc.**

## Technical Support Fax Back Form

Please record the following information to help expedite any warranty claim:

Model No.: \_\_\_\_\_ Serial No.: \_\_\_\_\_

Date Purchased: \_\_\_\_\_

Place of Purchase: \_\_\_\_\_

Firmware Version: \_\_\_\_\_ HDD Brand and Model: \_\_\_\_\_

**To: Technical Support Group FAX: 1-818-678-0483**

FROM: \_\_\_\_\_ FAX: \_\_\_\_\_

E-MAIL \_\_\_\_\_

RE: \_\_\_\_\_ TEL: \_\_\_\_\_

DATE: \_\_\_\_\_ # OF PAGES: \_\_\_\_\_

I am experiencing the following issues with my HDD PortaCruiser:

---

---

---

---

---

By answering these questions, your problem will be solved more rapidly. Make copies as necessary. You can reach us electronically at: [www.aleratec.com](http://www.aleratec.com) on the internet.

**Notes:**

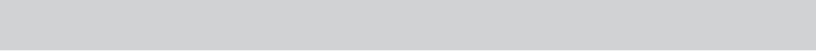

Document Number: 9399065\_ENG\_Rev. C  
Specifications subject to change without notice.

Copyright © 2009

Aleratec, Inc.  
9851 Owensmouth Avenue  
Chatsworth, CA 91311 U.S.A.

[www.aleratec.com](http://www.aleratec.com)