

MASTER[®]

A P P L I A N C E

Designers and Manufacturers
of Heat Tools for Industry

Ultratorch[®]

UT-300Si

Heat Tool

Instruction Manual

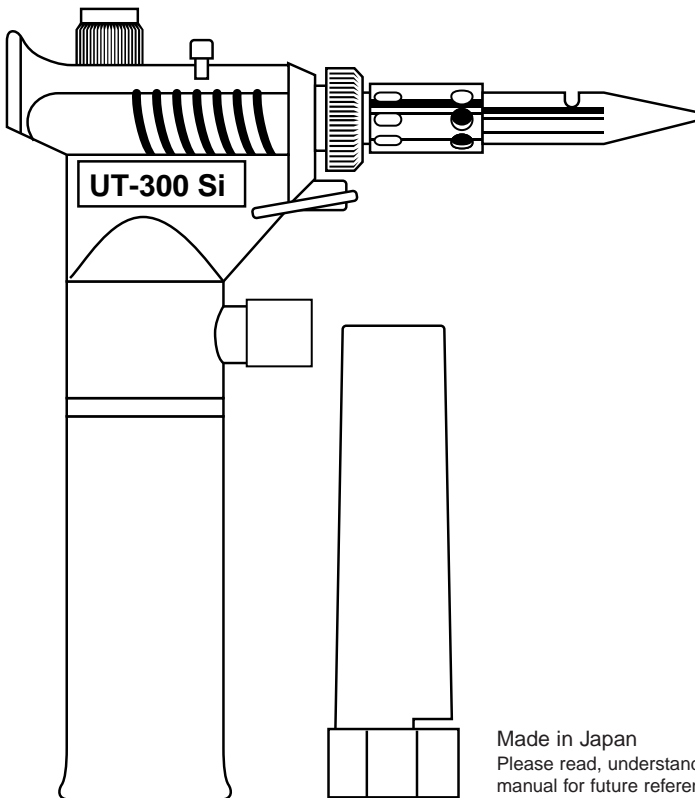

Made in Japan
Please read, understand and keep this
manual for future reference

Regulatory Information

Declaration of Conformity
(According to EN 45014)

Declares that the following product:

Quality Department
Master Appliance Corp.
FAX (262) 633-9745

Manufacturer's Name:
Master Appliance Corp.

Conforms to the following
product specifications:

Manufacturer's Address:
2420-18th Street
Racine, WI 53402 U.S.A.

Safety Directives:
EN 123 12.81
EN 292 parts 1&2 EN 294

IMPORTANT: Please read and understand all instructions before using this tool. Become familiar with all controls for your safety.

Description

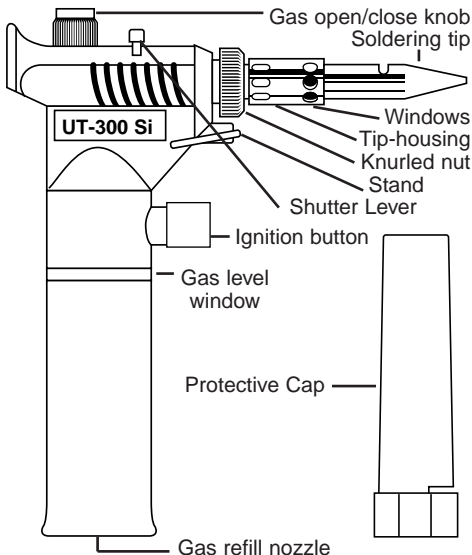

Set contents

1. Tool
2. Plastic cap
3. Operation manual

Specification

Size (with soldering tip):
7.32 in. x 6.77 in.
(186mm x 172mm)

Weight when gas filled:
Approx. 352 gr.

Temperature values:

Soldering tip end...
approx. 932°F/500°C

Hotblow tip end...
approx. 1112°F/600°C

Gas container capacity:
80 c.c.

Operating time per filling:
More than 3 hours

Principles of Operation

This product uses a catalytic gas reaction system. The special catalyst contained in the tip is preheated with a butane flame. The preheated flame is extinguished when the shutter is closed over the ignition vent.

Butane gas continues to flow over the preheated catalyst generating infrared heat which is either conducted through the soldering iron tip or passed through the heat tip as hot gas.

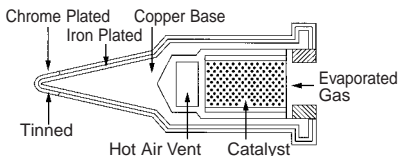

Fill with Ultratane™ Butane

Use only Master Ultratane butane with your Ultratorch. Do not fill gas or store near open flame, heater, furnace or combustible materials.

Fill gas holding the unit firmly with the refill nozzle pointed upwards. Gas will overflow from nozzle when tank is full.



Ignition Instructions

1. Turn gas open/close knob counter clockwise slightly toward + as marked on the knob.
2. Push ignition button.
3. When windows turn red, turn the shutter lever to right and hold for 3 seconds. Release lever, then it turns back automatically. Flame will turn off and the catalyst will start to react.

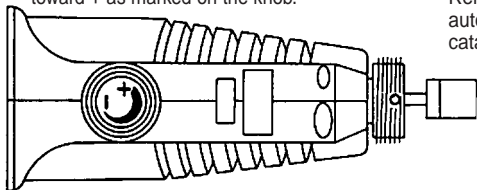

4. Tip temperature can be changed by adjusting the gas open/close knob.
5. To turn off unit - turn the gas open/close knob clockwise until knob is seated in locked position.

Use as a Soldering Iron or Heat Tool

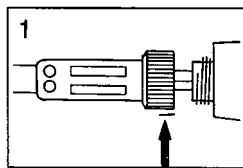

Knurled nut

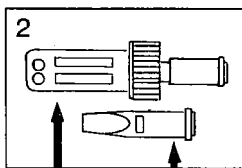

Tip housing

Soldering tip

1. Loosen knurled nut to remove tip and tip housing.
2. Replace soldering tip with hotblow tip and re-install tip housing onto unit.

Important Safety Instructions

To reduce the risk of injury or property damage, READ AND UNDERSTAND the following warnings:

1. To prevent fire or damage to work surfaces, be sure hot air exhaust opening is positioned up. Hot air comes out of the exhaust opening in the tip. Keep combustibles and hands away from the opening.
2. To prevent fuel tank leakage, do not store in environmental area that exceeds 104°F/40°C (such as car dashboard or trunk, direct sun, glove compartment, or other enclosed, unventilated areas).
3. Be sure to turn "ON/OFF" switch to "OFF" after use.
4. Do not perform maintenance or repair unless unit is completely cool. Be certain "ON/OFF" lever is "OFF".
5. Wait for tips to cool before changing. Keep hands and combustibles from tip area while in use.
6. When soldering or desoldering always review material safety data sheets (MSDS) for recommended precautions for safe handling and use of solder, solder paste, flux, conformal coatings and any other chemicals.
7. Store away from, and do not use in the presence of children.
8. Keep protective cap on unit while not in use.
9. Use only in well-ventilated area. Continuous or extended use indoors should be done only with a local exhaust ventilation to the outside.
10. Do not expose to open flame or other sources of high temperature.
11. To prevent clouding of window, do not use alcohol or alcohol-based cleaner.
12. Use only Master Appliance Ultratane Butane Fuel to insure maximum safety and performance. MSDS upon request.
13. Always use safety glasses or goggles.
14. Do not fill gas or store near open flame, heater, furnace or combustible materials.
15. Do not misuse, abuse, alter or tamper.
16. It is your responsibility to follow your governmental regulations when disposing of this unit.

NOTE: When operating in extremes of temperature (hot or cold), at high altitude, ignition may be difficult due to the variation of gas pressure caused by these extremes. Gas control settings will also be affected and will vary from those under normal conditions. If difficulties are experienced, please contact our Customer Service Department who will advise on adjustment.

Warnings:

WARNING: This product, when used for soldering and similar applications, produces chemicals known to the State of California to cause cancer and birth defects or other reproductive harm.

WARNING: The Department of Transportation Hazardous material Regulations forbid the carriage of butane or other flammable gas products on passenger aircraft. Do not pack this item or any other flammable gas item, in any checked or carry-on baggage.

To Replace Ejector

HOW TO REMOVE

1. Loosen knurled nut and remove tip and tip housing.

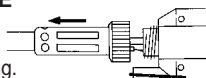

2. Un-screw the screw with minus-head driver as illustrated.

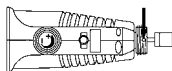

3. Pull out the burner.

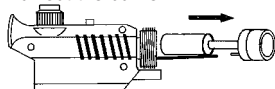

4. Loosen the ejector by inserting the minus-head driver and turn counter clockwise.

The ejector will come out when tilting the unit toward you.

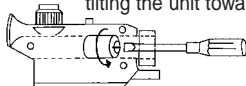

HOW TO MOUNT

1. Mount new ejector and tighten with minus-head driver turning clockwise.

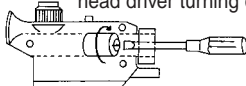

2. Insert the lead wire into the ceramic pipe on the burner and push until the burner does not go further.

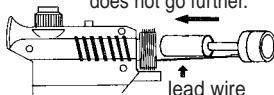

(Lead wire should be straight along with burner.)

3. Tighten the screw. (The screw will not be tightened completely if the lead wire is not inserted properly.)

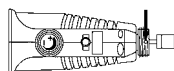

Storage of Your Ultratorch Heat Tool

1. Allow unit to cool and put protective cap on for storage.
2. If your unit is not going to be used for awhile, store in the following manner. Store in proper location avoiding elevated temperatures and away from children.
3. Leave tank approximately 1/2 full so lubrication of fuel pickup filter stays wet.
4. Set flow control valve at setting X.

How to Empty Tank of Butane Gas if Needed

1. Only empty fuel tank in a well ventilated area and away from ignition sources. Remember butane is heavier than air.
2. Depress the filler valve at the back of the tank with a small bladed screwdriver and let the butane gas escape through the small orifice opening. It takes approximately one minute for the butane to escape from the tank. Be careful that the butane does not hit against your fingers or hands. This could cause frostbite of the skin.
3. One method is to poke a small bladed screwdriver through a piece of paper and then carefully depress the filler valve. The escaping gas will hit the paper and not your hand.
4. Never turn gas lever to "ON" and allow gas to evacuate through the ejector/tip. Doing

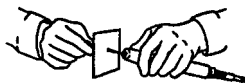

this will clog the ejector and lead to premature failure.







5. Never try to unscrew the filler valve as it is adhesively bonded to the tank. Breaking of this bond will destroy the unit, causing the tank to leak.

Trouble Shooting

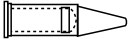

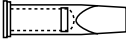
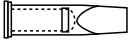

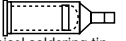
Problem	Probable cause	Solution
Does not ignite	a. Empty tank b. Clogged ejector c. Too high or too low gas pressure d. Damaged burner	a. Refill with butane fuel b. Replace with new ejector c. Adjust gas open/close knob d. Replace with new burner
Does not flame off	When make a low roaring sound, the flame is not turned off	Turn the shutter lever again and hold for 3 seconds
Tip does not heat up	a. Used-up catalyst b. Insufficient gas pressure	a. Replace with new tip b. Refill with butane gas

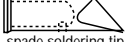
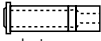
Optional Accessories

Soldering Tips

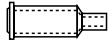
72-01-01 3mm dia. tapered needled soldering tip		72-01-05 1.5mm dia. tapered needle soldering tip		72-01-11 7mm dia. chisel soldering tip (std)	
72-01-02 10mm dia. chisel soldering tip		72-01-06 4mm dia. micro spade soldering tip		72-01-12 4mm dia. chisel soldering tip	
72-01-03 4mm dia. spade soldering tip		72-01-07 1.5mm tapered pyramid soldering tip		72-01-13 12.5mm dia. spade soldering tip	
				72-01-14 soldering tip adaptor (5mm dia. x 0.8mm pitch)	

Heat Tips

72-01-51 5.6 O.D./3.6 I.D. (mm)		72-01-52 8.8 O.D./6.6 I.D. (mm)		72-01-53 11.5 O.D./9.7 I.D. (mm)			Outside diameter ↑ ↓ Inside diameter
------------------------------------	---	------------------------------------	---	-------------------------------------	---	---	---

Heat Shrink Attachment

72-01-55 (std)

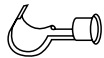

Carrying Strap

72-52U



Protective Cap

78-02

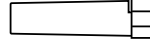

Ultratane™ Butane

"ULTRA-REFINED" by Master...the only approved butane for Ultratorches.

- Single piece universal tip
- Purest refining method possible
- Special non-clogging formula to permit extended use

P/N 51773 - 5.125 oz.

P/N 10448 - 26gm. canisters



One Full Year Warranty

Your butane powered heat tool was carefully tested and inspected before it was shipped from the factory. We warrant this product to be free from defects in materials and workmanship under normal use and service for one year from date of purchase. In the event of a defect in materials or workmanship, we will either repair or replace, without charge, at our option, any part which in our judgement shows evidence of such defect.

This warranty does not apply to the attachments, tips, burner, or ejector, which are items requiring periodic replacement, nor does it apply if the butane powered heat tool has been misused, abused, altered, tampered with, or used with butane fuel other than Master Appliance Ultratane butane fuel. At the end of the warranty period, Master Appliance shall be under no further obligation, expressed or implied. Some states do not allow limitations on how long an implied warranty lasts, so the above limitation may not apply to you.

Master Appliance assumes no responsibility for and this warranty shall not cover any incidental or consequential damages from any defect in this product or its use. Some states do not allow the exclusion or limitation of incidental or consequential damages, so the above exclusion may not apply to you.

This warranty gives you specific rights and you may also have other rights which may vary from state to state.

For warranty repair a proof of purchase receipt or other appropriate proof of date is required with your return for warranty repair to Master Appliance. All warranty claims must be made to Master Appliance and not the distributor. We decline responsibility where repairs have been made or attempted by others. Any different guarantee made by others is not authorized by us. If a warranty claim is to be made please return your Master Heat Tool prepaid, with proof of pur-

chase and a note describing the problem to our Repair Department. The Department of Transportation Hazardous Material Regulations forbid this item or any other flammable gas item from being shipped via air. **Please empty tool of butane before shipping** as described in this manual under "How to Empty Tank of Butane Gas if Needed". See address below.

For repair service we charge a flat rate fee. Please call Master Appliance for the flat rate charge. return your Master Heat Tool prepaid, with a note describing the problem to:

Master Appliance Corp.
Attention: Repair Department
2420 - 18th Street
Racine, Wisconsin 53403
Phone (262) 633-7791
Fax (262) 633-9745
web: www.masterappliance.com
e-mail: sales@masterappliance.com

Form #53073