

BUNN®

***ITCB
ITCB-DV
Infusion Series***®

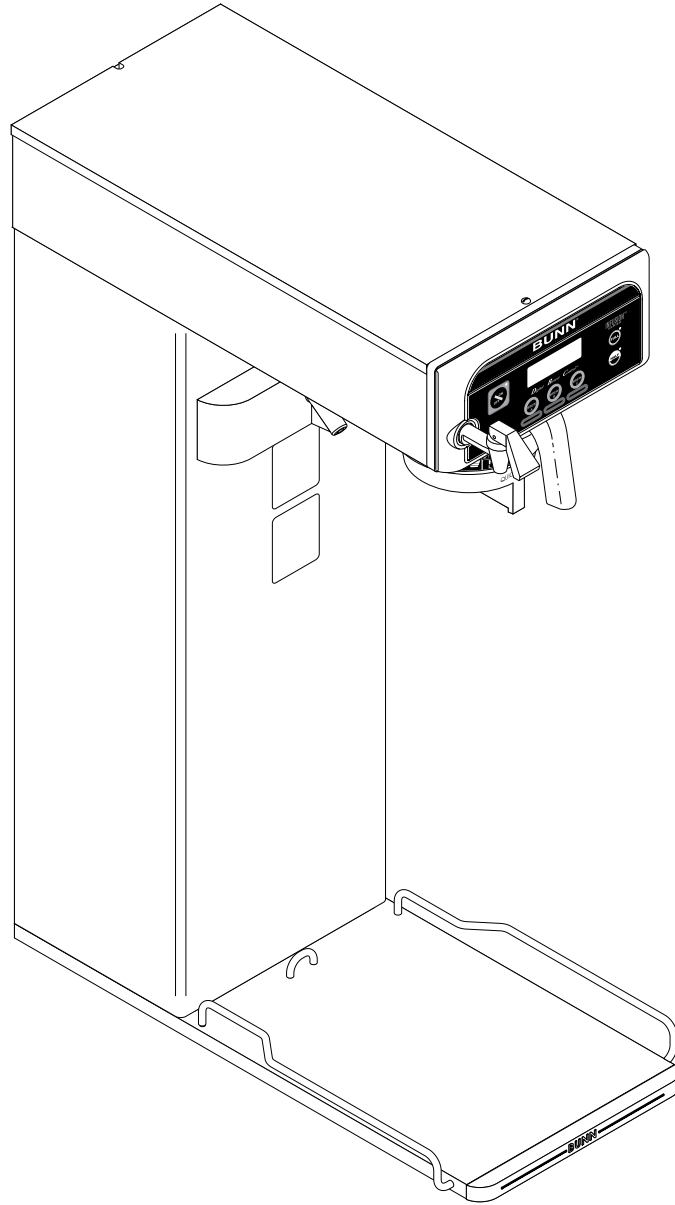

OPERATING & SERVICE MANUAL

BUNN-O-MATIC CORPORATION

POST OFFICE BOX 3227

SPRINGFIELD, ILLINOIS 62708-3227

PHONE: (217) 529-6601 FAX: (217) 529-6644

BUNN-O-MATIC COMMERCIAL PRODUCT WARRANTY

Bunn-O-Matic Corp. ("BUNN") warrants equipment manufactured by it as follows:

- 1) All equipment other than as specified below: 2 years parts and 1 year labor.
- 2) Electronic circuit and/or control boards: parts and labor for 3 years.
- 3) Compressors on refrigeration equipment: 5 years parts and 1 year labor.
- 4) Grinding burrs on coffee grinding equipment to grind coffee to meet original factory screen sieve analysis: parts and labor for 3 years or 30,000 pounds of coffee, whichever comes first.

These warranty periods run from the date of installation BUNN warrants that the equipment manufactured by it will be commercially free of defects in material and workmanship existing at the time of manufacture and appearing within the applicable warranty period. This warranty does not apply to any equipment, component or part that was not manufactured by BUNN or that, in BUNN's judgment, has been affected by misuse, neglect, alteration, improper installation or operation, improper maintenance or repair, damage or casualty. This warranty is conditioned on the Buyer 1) giving BUNN prompt notice of any claim to be made under this warranty by telephone at (217) 529-6601 or by writing to Post Office Box 3227, Springfield, Illinois 62708-3227; 2) if requested by BUNN, shipping the defective equipment prepaid to an authorized BUNN service location; and 3) receiving prior authorization from BUNN that the defective equipment is under warranty.

THE FOREGOING WARRANTY IS EXCLUSIVE AND IS IN LIEU OF ANY OTHER WARRANTY, WRITTEN OR ORAL, EXPRESS OR IMPLIED, INCLUDING, BUT NOT LIMITED TO, ANY IMPLIED WARRANTY OF EITHER MERCHANTABILITY OR FITNESS FOR A PARTICULAR PURPOSE. The agents, dealers or employees of BUNN are not authorized to make modifications to this warranty or to make additional warranties that are binding on BUNN. Accordingly, statements by such individuals, whether oral or written, do not constitute warranties and should not be relied upon.

If BUNN determines in its sole discretion that the equipment does not conform to the warranty, BUNN, at its exclusive option while the equipment is under warranty, shall either 1) provide at no charge replacement parts and/or labor (during the applicable parts and labor warranty periods specified above) to repair the defective components, provided that this repair is done by a BUNN Authorized Service Representative; or 2) shall replace the equipment or refund the purchase price for the equipment.

THE BUYER'S REMEDY AGAINST BUNN FOR THE BREACH OF ANY OBLIGATION ARISING OUT OF THE SALE OF THIS EQUIPMENT, WHETHER DERIVED FROM WARRANTY OR OTHERWISE, SHALL BE LIMITED, AT BUNN'S SOLE OPTION AS SPECIFIED HEREIN, TO REPAIR, REPLACEMENT OR REFUND.

In no event shall BUNN be liable for any other damage or loss, including, but not limited to, lost profits, lost sales, loss of use of equipment, claims of Buyer's customers, cost of capital, cost of down time, cost of substitute equipment, facilities or services, or any other special, incidental or consequential damages.

BUNN, Infusion Series, BrewWISE, CDBC, DBC, ITCB, MHG, Pre-Infusion, Pulse Brew, Smart Funnel, Energy Savings, BUNNLink, Smart Reader, Freshness Timer and Sanitation Alert are either trademarks or registered trademarks of Bunn-O-Matic Corporation.

INTRODUCTION

This equipment will brew either tea or coffee into an awaiting dispenser or reservoir. It can be easily configured for 120V 15 amp, 120/208V 20 amp or 120/240V 20 amp. The brewer may have an auxillary hot water faucet. It is only for indoor use on a sturdy counter or shelf.

The Infusion Series combines BrewWISE, CDBC and Tea Brewers into one. ITCB is able to brew both tea and coffee with recipe settings and has the following features: Pre-Infusion and Pulse Brew, quick and standard brew, and BrewWISE. It has an LCD for digital readout and programming along with the Smart Funnel options for coffee. The user is able to select regular or quick brew for tea programming. Other features are Energy Savings mode, BUNNLink compatible, Smart Reader compatible, Freshness Timer and Sanitation Alert.

CONTENTS

| | |
|-------------------------------|---------------------------------|
| Warranty | 2 |
| Introduction | 3 |
| User Notices | 4 |
| Electrical Requirements | 6 |
| Plumbing Requirements | 7 |
| Tank Drain | 7 |
| Operating Controls | 8 |
| Initial Set-Up | 9 |
| Tea Brewing | 9 |
| Coffee Brewing | 10 |
| Cleaning | 11 |
| Glossary | 12 |
| Programming | 14 |
| Troubleshooting | 63 |
| Wiring Diagrams | 77 |
| | |
| ITCB-DV | Dual Voltage Machine |
| ITCB-C-DV | Dual Voltage Machine for Canada |
| ITCBA | 230 Volt Machine |
| ITCBB | 200 Volt Machine |

USER NOTICES

Carefully read and follow all notices in this manual and on the equipment. All labels on the equipment should be kept in good condition. Replace any unreadable or damaged labels.

This equipment is to be installed to comply with the Basic Plumbing Code of the Building Officials and Code Administrators International, Inc. (BOCA) and the Food Service Sanitation Manual of the Food and Drug Administration (FDA).

#00656.0000

|  WARNING |
|---|
| DO NOT OVERLOAD CIRCUIT. ALWAYS ELECTRICALLY GROUND THE CHASSIS OR ADAPTOR PLUG. DO NOT DEFORM PLUG OR CORD. FOLLOW NATIONAL AND LOCAL ELECTRICAL CODES. KEEP COMBUSTIBLES AWAY. |
| FAILURE TO COMPLY RISKS EQUIPMENT DAMAGE, FIRE OR SHOCK HAZARD. |
| READ THE ENTIRE OPERATING MANUAL BEFORE USING THIS PRODUCT <small>00986.0000E 5/98 ©1994 Bunn-O-Matic Corporation</small> |

#00986.0000

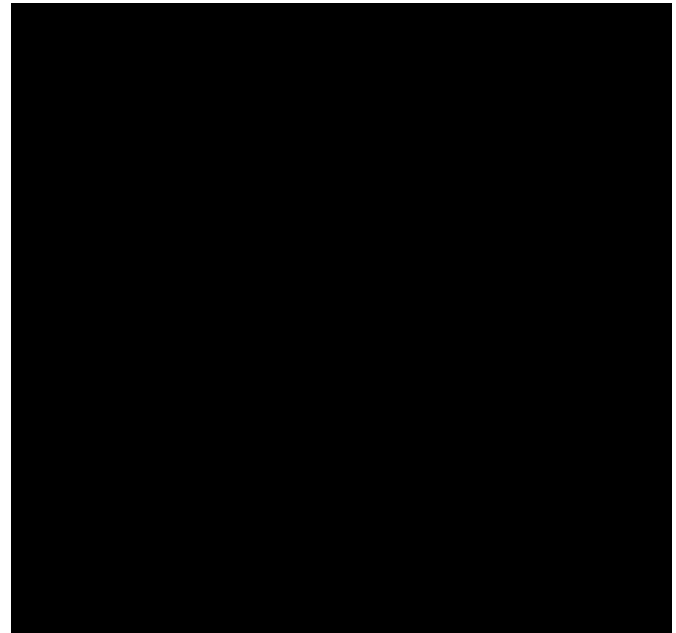

|  WARNING |
|---|
| To reduce the risk of electric shock, do not remove or open cover. No user-serviceable parts inside. Authorized service personnel only. Disconnect power before servicing. |

37881.0000

USER NOTICES (CONT.)

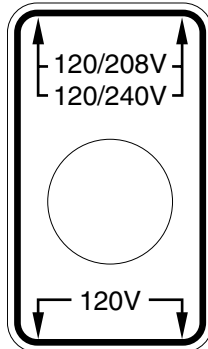

#34056.0001



#03408.0000

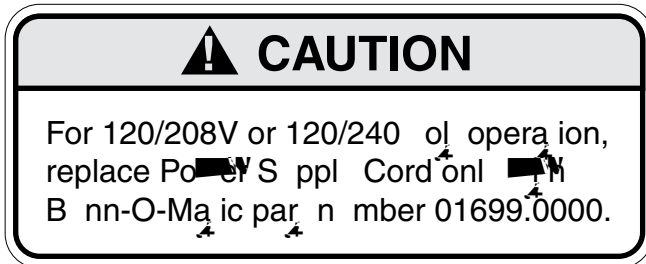

#34072.0000

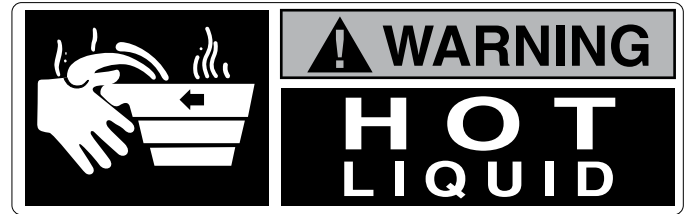

#03409.0000

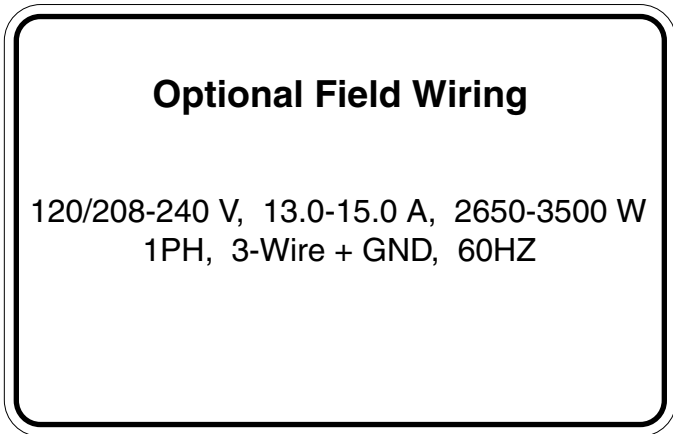

#29710.0009

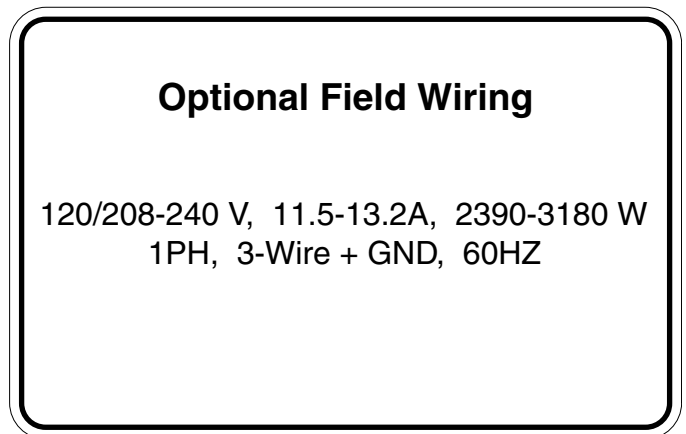

#29710.0010

ELECTRICAL REQUIREMENTS

WARNING - The brewer must be disconnected from the power source until specified in *Initial Set-Up*.

Requirements for brewers without an attached cord set are as follows:

Refer to Data Plate on the Brewer, and local/national electrical codes to determine circuit requirements.

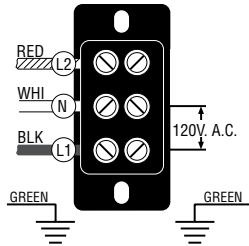

**120V AC
single phase models**

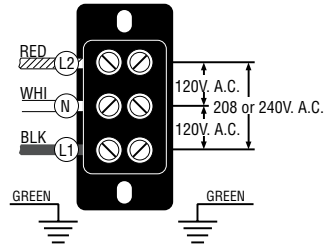

**120/208 & 120/240V AC
single phase models**

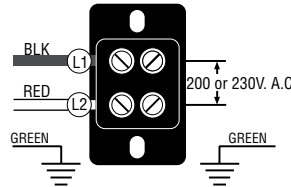

**200 or 230V AC
single phase models**

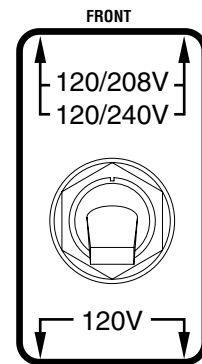
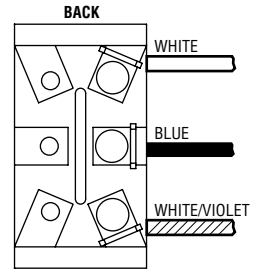

**DUAL VOLT
TOGGLE SWITCH**

Note: The two electrical services above require 3 current carrying conductors (Neutral, L1 and L2) and a separate conductor for earth ground

Note: This electrical service consists of 2 current carrying conductors (L1 and L2) and a separate conductor for earth ground.

ELECTRICAL HOOK-UP

CAUTION – Improper electrical installation will damage electronic components.

1. An electrician must provide electrical service.
2. Determine the available on-site electrical service.
3. Select the desired unit voltage based on the available on-site electrical service.
4. Using a voltmeter, check the voltage and color coding of each conductor at the electrical source.
5. Remove the back access panel to gain access to the terminal block.
6. Feed the supply leads through the strain relief at the rear of the brewer.
7. Using the above diagrams, connect the desired electrical service to the field wiring terminal block.
8. If wiring the machine for operation on 120/208 or 120/240 volts with a Power Supply Cord, the Power Supply Cord must be UL Listed Flexible Cord Type SO, SJO, SJTO, HSJO or SJOW, No. 12 AWG, 4 Conductor, Rated 90° C. Attachment Plug Cap must be UL Listed, NEMA 14-20P or L14-20P Configuration, Rated 125/250V, 20 AMPS. If wiring the brewer for operation at 200V or 230V with a Power Supply Cord, the Power Supply Cord must be of type “H07RN-F” with <HAR> marking, 1.5 mm² conductor size, rated minimum 90°C. Attachment male plug must be appropriate for Local/National use and must meet any Local/National Regulatory requirements/certifications if applicable. The Power Supply Cord must be at least 3 feet (.91 m) long and maximum 6 feet (1.82 m) long (measured from Strain Relief to end of the Attachment Plug Cap).
- NOTE:** If the power cord is damaged, it must be replaced by the manufacturer or its service agent or a similarly qualified person in order to avoid a hazard.
9. Connect the brewer to the power source and verify th
9. Connect the brewer to the power source and verify the voltage at the terminal block.
10. Set toggle switch on component bracket to the appropriate position and replace the access panel.
11. If plumbing is to be hooked up later be sure the brewer is disconnected from the power source. If plumbing has been hooked up, the brewer is ready for *Initial Set-Up*.

PLUMBING REQUIREMENTS

This brewer must be connected to a cold water system with operating pressure between 20 and 90 psi (138 and 620 kPa) from a ½" (12.7 mm) or larger supply line. A shut-off valve should be installed in the line before the brewer. Install a regulator in the line when pressure is greater than 90 psi (620 kPa) to reduce it to 50 psi (345 kPa). The water inlet fitting is ¼" (6.35 mm) flare.

NOTE - Bunn-O-Matic recommends ¼" (6.35 mm) copper tubing for installations of less than 25 feet (7.62 m) and ⅜" (9.5 mm) for more than 25 feet (7.62 m) from the ½" (12.7) water supply line. A tight coil of copper tubing in the water line will facilitate moving the brewer to clean the counter top. Bunn-O-Matic does not recommend the use of a saddle valve to install the brewer. The size and shape of the hole made in the supply line by this type of device may restrict water flow.

This equipment must be installed to comply with the Basic Plumbing Code of the Building Officials and Code Administrators International, Inc. (BOCA) and the Food Service Sanitation Manual of the Food and Drug Administration (FDA). For models installed outside the U.S.A., you must comply with the applicable Plumbing/Sanitation Code for your area.

PLUMBING HOOK UP

1. Flush the water line and securely attach it to the inlet fitting at the bottom rear of the brewer.
2. Turn on the water supply.

TANK DRAIN

1. Remove back access cover.
2. Close the white clamp on the drain hose.
3. Unfasten the hose clamp at the inlet valve. Remove the hose from the valve.
4. Place the end of the drain hose in a container that has a minimum capacity of 2.0 gallons (7.5 liters).
5. Release the white clamp to drain the water from the tank.
6. When tank is empty, leave the white clamp open, and install the hose back on the valve. Tighten the hose clamp at the end of the hose around the valve fitting.
7. Replace the back access cover.

OPERATING CONTROLS

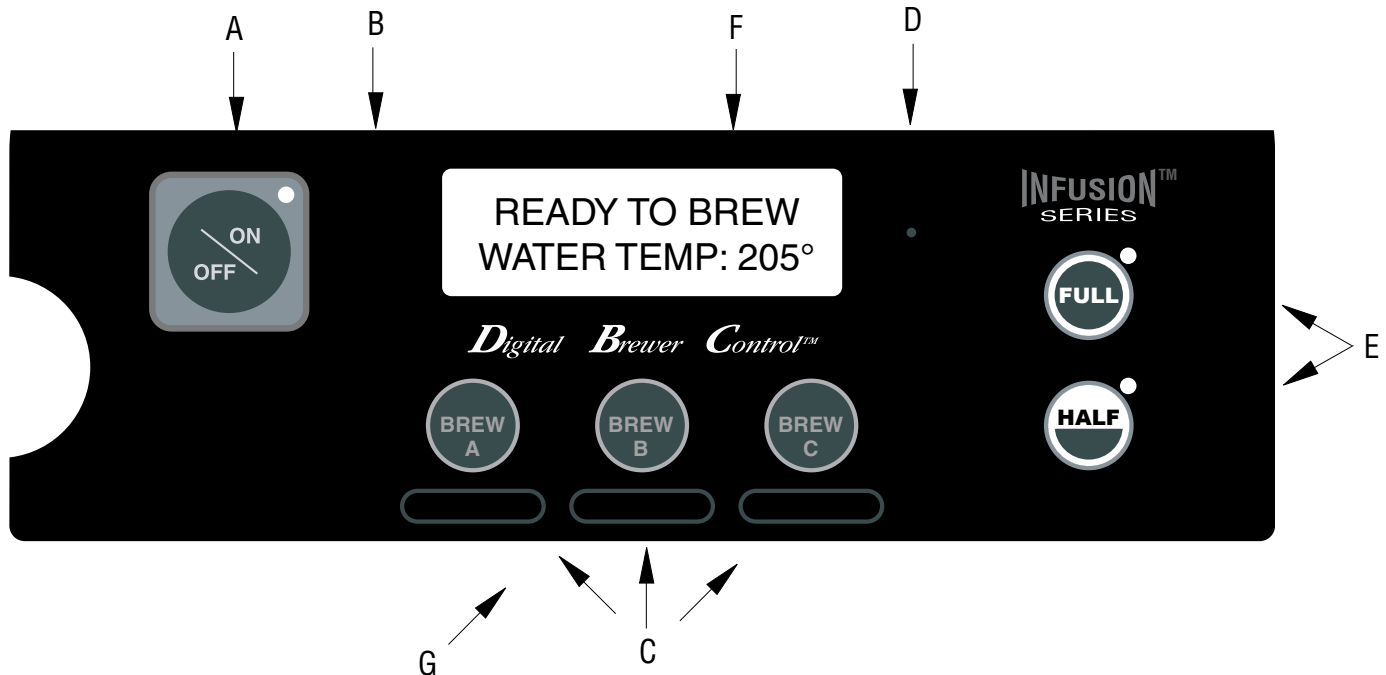

A. ON/OFF SWITCH

Pressing the "ON/OFF" pad will alternately turn the brewer on and off. Pressing this pad during the brew cycle will interrupt the brew cycle, stopping the flow of water. Pressing this pad during programming of the brewer will exit the setup and return to the main screen.

B. PROGRAMMING (left)

This hidden pad can be used to scroll backwards through the function list while in programming mode.

C. BREW (A,B,C) and FUNCTION

When the ON/OFF is ON and the brewer is on the main screen (not in programming mode), momentarily pressing and releasing this pad will begin a brew cycle. These are also used to program the brewer when in the programming mode.

D. PROGRAMMING (right)

Pressing and holding this pad allows entry into the programming menus. Pressing and releasing the pad steps through each function screen while in the programming mode.

E. BATCH SELECTOR PADS

Pressing the pad corresponding to the Half or Full batch selects the amount of product to be brewed. Pressing a different pad after a brew cycle has been initiated does not change the brew batch in progress. Light indicates the selected batch to brew. Also used in programming to adjust settings on both batch sizes.

F. FUNCTION SCREEN

This is the display which shows the various functions of the brewer and allows the programming to be accomplished.

G. FUNNEL SENSING COIL

This is used to "receive" information from the Smart Funnel handle, recipe cards, and ad cards.

1. Insert an empty funnel into the funnel rails.
2. Place an empty server under the funnel.
3. Connect the brewer to the power source. Make sure the ON/OFF switch is ON (LED will be lit).
4. Water will flow into the tank and stop when the tank is filled to its capacity. Display will show **PLEASE WAIT...TANK FILLING** until tank is filled with water.
5. Wait approximately twenty minutes for the water in the tank to heat to the proper temperature. Display will show **READY TO BREW...WATER TEMP: 205°** when tank is at operating temperature. Some water will drip from the funnel during this time; this is due to expansion and should not occur thereafter.
6. Place a small vessel beneath the faucet and open the faucet handle. Release it when you hear the tank refilling.
7. Water volumes and flow settings have been preset at the factory. Refer to adjustments for the Set Brew Volumes section of this manual should the volume need to be increased or decreased.
8. The brewer is now ready for use in accordance with the instructions for Tea Brewing and Coffee Brewing.

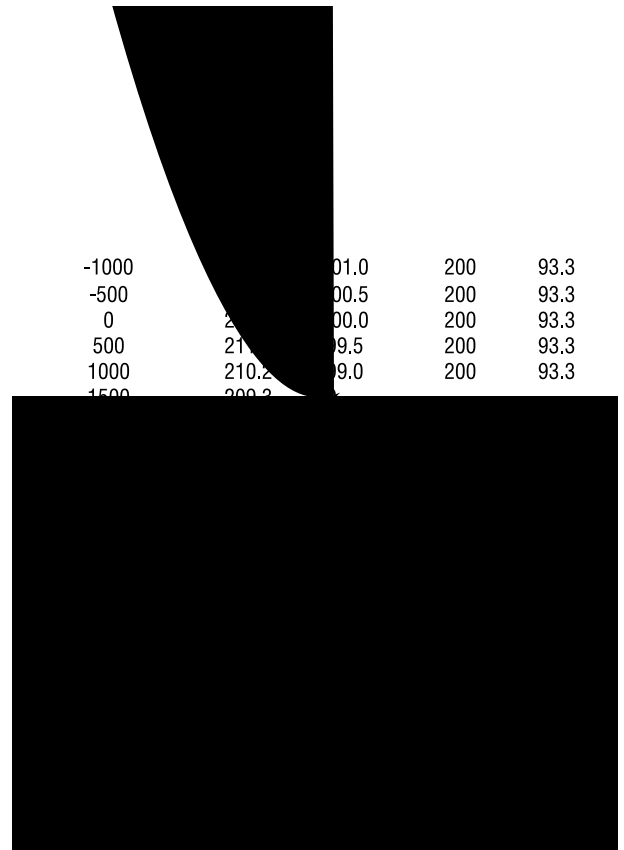

| | | | | |
|-------|-------|------|-----|------|
| -1000 | | 01.0 | 200 | 93.3 |
| -500 | | 00.5 | 200 | 93.3 |
| 0 | | 00.0 | 200 | 93.3 |
| 500 | 21 | 09.5 | 200 | 93.3 |
| 1000 | 210.2 | 09.0 | 200 | 93.3 |
| 1500 | 200.2 | | | |

VIEWING ASSIGNED RECIPES & ASSET NUMBER

1. Make sure the ON/OFF switch is OFF (LED will not be lit).
2. Press and hold BREW A. The display will show the name of the recipe assigned to Brew A along with SWITCH NOT ON. This is to indicate that a brew cannot be initiated while the ON/OFF switch is OFF.
3. Repeat for BREW B and BREW C.
4. Make sure the ON/OFF switch is OFF. To view the asset number of the machine, press and hold the left hidden button until the display reads: **ANXXXXXX...ASSET NUMBER**. Release the left hidden button.
5. After a 5 second delay, the display will read: **ITCBXXXXXX**. This is the serial number of the machine.

TEA BREWING

1. Begin each brew cycle with a clean empty brew funnel and server. (Be sure the server lid doesn't interfere with the flow of dilution water.)
2. Insert a BUNN filter into the funnel.
3. Pour the packet of loose fresh tea leaves into the filter. Approximately three to five ounces is recommended for three gallons of beverage.
4. Level the bed of tea leaves by gently shaking.
5. Slide the funnel into the funnel rails until it stops.
6. The ON/OFF must be ON. Select which batch size to brew.
7. Momentarily press and release the assigned BREW button. There may be certain situations in which the brew cycle will not begin when BREW is pressed:
 - a. **SWITCH NOT ON** - ON/OFF must be ON.
 - b. **BREW TEMPERATURE TOO LOW** – wait until heated or cancel **BREW LOCKOUT** option (Page 17).
 - c. **CHECK FUNNEL** – remove funnel, empty previously brewed leaves and replace with fresh tea leaves.
 - d. **DISABLED** - select different brew button or batch size.
8. If none of the above messages are displayed, the display will read **NOW BREWING** and show the time remaining in the brew cycle.
9. Following the brew will be a countdown of drip time **DRIPPING** which shows the time remaining until the tea no longer drips from the funnel tip.
10. Carefully remove the brew funnel and discard the tea leaves and filter only after visible dripping stops.

COFFEE BREWING

WITHOUT A SMART FUNNEL AND G9-2T DBC GRINDER:

1. Begin each brew cycle with a clean empty brew funnel.
2. Insert a BUNN filter into the funnel.
3. Pour the fresh coffee into the filter and level the bed of grounds by gently shaking.
4. Slide the funnel into the funnel rails until it stops.
5. Place an empty server under the funnel.
6. The ON/OFF must be ON. Select the FULL batch size.
7. Momentarily press and release the assigned BREW button. There may be certain situations in which the brew cycle will not begin when BREW is pressed:
 - a. **SWITCH NOT ON** - ON/OFF must be ON.
 - b. **BREW TEMPERATURE TOO LOW** – wait until heated or cancel **BREW LOCKOUT** option (Page 17).
 - c. **CHECK FUNNEL** – remove funnel, empty previously brewed grounds and replace with fresh.
 - d. **DISABLED** - select different brew button or batch size.
 - e. **COFFEE FUNNEL?** – appears when brew volume is greater than 86.0 oz. (2.54 L) and pulse brew is disabled. Check to make sure the correct funnel is in place, and then press BREW again.
8. If none of the above messages are displayed, the display will read **NOW BREWING** and show the time remaining in the brew cycle.
9. Following the brew will be a countdown of drip time **DRIPPING** which shows the time remaining until the coffee no longer drips from the funnel tip.
10. Carefully remove the brew funnel and discard the grounds and filter only after visible dripping stops.

WITH A SMART FUNNEL AND G9-2T DBC or MHG GRINDER:

1. Select the small batch size on the grinder.
2. Insert a BUNN filter into the funnel.
3. Grind the selected amount of fresh coffee into the Smart Funnel using the G9-2T DBC or MHG with Smart Funnel operation and level the grounds by gently shaking.
4. Slide the funnel into the funnel rails. The brewer will read the coffee name and size ground through the chip in the funnel handle.

NOTE: The brewer will automatically match the brew batch size to the grinder batch size:

| <u>GRINDER</u> | <u>BREWER</u> |
|----------------|---------------|
| Small | Half Batch |
| Medium | Full Batch |
| Large | *Full Batch |

*If BREW is pressed with a large grinder batch, the display will read: **INCORRECT GRIND...BATCH SIZE WRONG**, and then **PRESS BREW TO BREW ANYWAY**.

5. Place an empty server under the funnel.
6. The ON/OFF must be ON.
7. Momentarily press and release the assigned BREW button. There may be certain situations in which the brew cycle will not begin when BREW is pressed:
 - a. **SWITCH NOT ON** - ON/OFF must be ON.
 - b. **BREW TEMPERATURE TOO LOW** – wait until heated or cancel **BREW LOCKOUT** option (Page 17).
 - c. **CHECK FUNNEL** – remove funnel, empty previously brewed grounds and replace with fresh.
 - d. **INCORRECT GRIND** - Indicates a large batch was ground using the grinder. Check batch size and grind weight.
8. If none of the above messages are displayed, the display will read **NOW BREWING** and show the time remaining in the brew cycle.
9. Following the brew will be a countdown of drip time **DRIPPING** which shows the time remaining until the coffee no longer drips from the funnel tip.
10. Carefully remove the brew funnel and discard the grounds and filter only after visible dripping stops.

CLEANING

CAUTION – CLEAN AND SANITIZE YOUR ICED TEA BREWER **DAILY**

1. Remove and thoroughly clean the entire brew funnel. The funnel tip and screen must be free from any tea particles or residue. Reassemble the funnel.
2. Remove and thoroughly rinse the sprayhead. The holes must be open and clear of any mineral deposits. Wipe the sprayhead panel clean with a damp cloth.

NOTE – Any buildup on the sprayhead may restrict water flow, and impact your brewing. For consistently great tea and coffee, clean sprayhead weekly with sprayhead cleaning tool (#38227.0000). Upon visual inspection it may appear that light passes through all holes in the sprayhead, but a thin film of residue can pass light and still impede water flow.

- a. Remove sprayhead from brewer.
 - b. Use the pointed end of sprayhead cleaning tool to remove any mineral deposits from the sprayhead holes.
 - c. Insert the long end of sprayhead cleaning tool into the sprayhead fitting, and rotate several times to remove any mineral deposits from the fitting.
3. The use of a damp cloth rinsed in any mild, nonabrasive, liquid detergent is recommended for cleaning all surfaces on Bunn-O-Matic equipment. Do **NOT** clean this equipment with a water jet device.

CAUTION – DO NOT KEEP BREWED ICED TEA OVERNIGHT. THE SERVER MUST BE CLEANED DAILY.

See page 50 of instruction manual for calibration routine to verify sprayhead flow rate matches programmed flow rate. Brewer may need to be re-calibrated due to lime build up. If brewer is cleaned and build up removed, brewer must be re-calibrated to achieve desired volumes.

GLOSSARY

AD CARD: An assembly consisting of computer chips and an instruction label. Used for loading advertising messages into the brewer.

AUTO PULSE BREW SETUP: The setting of a pulse brew routine by entering in the total desired brew time. The brewer will then calculate and perform a pulse brew routine using a predetermined formula.

BREW LOCKOUT: The inability to initiate a brew if the water temperature is less than the ready temperature programmed into the brewer.

CHIP: A computer chip containing either recipes for specific coffee flavors or advertising messages that are read by the sensing coil on the brewer. One chip is embedded in each Smart Funnel handle to carry the coffee flavor name and batch size ground from the grinder to the brewer.

DILUTION: Water added to tea concentrate.

DILUTION DELAY: The length of time from when the brew is initiated until the dilution water starts.

DRIP TIME: The length of time from when the water spray over the grounds ends to the time when no water or product drips from the funnel tip.

ENERGY SAVINGS MODE: If enabled, the brewer will either shut down or reduce the tank holding temperature to 140°F (60°C) after the set idle time.

FACTORY DEFAULTS: The factory preset brew settings that were installed into the brewer's memory.

FIRST ON-TIME: During a pulse brew, this is the time set for the initial flow of water over the grounds or tea leaves.

FRESHNESS TIMER: If enabled, the brewer will display an alert if a new tea or coffee batch has not been brewed before the set time has expired.

FUNNEL SENSING COIL: A sensor at the front of the brewer that reads what name and batch size of coffee was ground into the funnel and allows for the brewer to automatically set itself to what is read from the funnel handle. Also used to read in recipe and ad card information.

IDLE TIME (ENERGY SAVINGS MODE): If ENERGY SAVINGS Mode is enabled, the length of time the brewer is inactive before the machine turns off or holds at 140°F (60°C).

LAST ON-TIME: During a pulse brew, this is the time set for the second on-time and each alternative on-time for the remainder of the brew.

MAIN SCREEN: The term used to describe the screen that is displayed when the brewer is not in use. This screen is also displayed after exiting the programming mode.

MANUAL PULSE BREW SETUP: The setting of a pulse brew routine by manually entering in the 1st on time, off time and last on time.

MASTER TEMP: The temperature at which the tank will heat to and hold. If the brewer is in Master Temp mode, all initiated brews will be at this temperature.

OFF-TIME: During a pulse brew or preinfusion, this is the time set for the length of time that the water is not spraying over the grounds.

PREINFUSION: The process of beginning a brewing cycle with an initial spray of water onto the grounds followed by a pause in the spray. After the programmed pause, the spray continues without interruption until the end of the brewing cycle.

PULSE BREW: The process that allows the brew water to start, and then stop, repeatedly over the grounds or tea leaves in order to derive the best flavor from the coffee or tea. Pulse brew is also used in some instances to prevent a funnel overflow.

GLOSSARY (Continued)

RECIPE: Set of brewing parameters stored in the brewer. The parameters are unique for each tea and coffee name. Tea recipes include brew ounces, dilution ounces, dilution delay, pulse brew, and drip time. Coffee recipes include brew ounces, pulse brew and drip time.

RECIPE CARD: An assembly consisting of a computer chip and an instruction label. Used for loading a recipe into the brewer and the companion DBC Grinder.

RECIPE TEMPS: Allows a different temperature to be set for each brew recipe.

NOTE – Using this setting will override the Master Temp setting. The tank will hold at the lowest set temperature. A short heating time may be required if all brew recipes are not set at the same temperature.

SANITATION MODE: If enabled, the brewer will display a message after a set amount of time indicating the machine needs cleaning and sanitizing.

TEA 1, TEA 2, TEA 3, HOT TEA, ICED COFFEE, NO-NAME COFFEE: The preset recipes stored in the brewer. Used by the brewer when there is no coffee name stored in the Smart Funnel or if a recipe card is not used.

WARNING TIME (FRESHNESS TIMER): If the Freshness Timer is enabled, the length of time from when the brew was completed until a “Freshness Alert” message will display, communicating that a fresh batch of product needs to be brewed.

PROGRAMMING

Using the menu-driven display on the front of the brewer, the operator has the ability to alter or modify various brewing parameters such as brew temperatures, brew volumes, dilution volumes, pulse brew, etc. This allows for the precise brewing of various flavors of tea and coffee.

Programming of the brewer is achieved by entering a certain function. Then, by the use of hidden programming switches and the brew/function buttons, the operator can customize the brewing process to their specifications.

PROGRAMMING SWITCHES

To access the programming mode, and to scroll through the different function screens, hidden programming switches are used. There are five of these switches that will be used for the setup of the brewer.



PROGRAMMING THE BREWER

The programming of the brewer is divided into two levels. There is one function in Level 1. All other functions are accessed in Level 2.

The following function screens are in order of appearance. Each screen will have instructions on how to access and the procedures to program the various functions of the brewer.

IMPORTANT PROGRAMMING NOTES - READ CAREFULLY -

To exit the programming mode at any time, press and release the ON/OFF pad located on the front switch panel. The display will return to the **MAIN SCREEN**.

If none of the five programming switches are pressed within one minute during the setup of the brewer, the programming of the function screen that is being set will be exited and the display will return to the **MAIN SCREEN**.

Always remember to place a container and funnel under the sprayhead when operating the brewer during the set-up of **CALIBRATE FLOW**, and testing the brew and dilution valves in **SERVICE TOOLS/TEST OUTPUTS**.

MAIN SCREEN

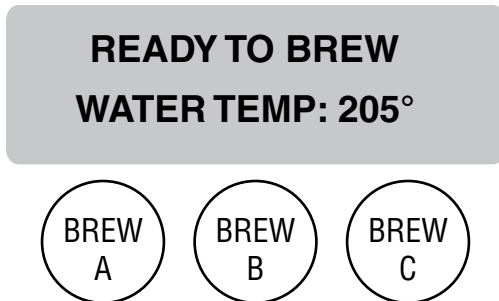

This screen will be shown when the brewer is ready for use. The screen displays the water temperature in the tank. When the water in the tank reaches the correct set temperature, the display will change from **HEATING** to **READY TO BREW**.

PROGRAMMING LOCKOUT SWITCH ((located on the memory module board prior to S/N ICB0007479 - located on the main circuit board S/N ICB0007479 and after))

This switch can be set to prevent access to the programming settings of the brewer. Once all the correct brew settings are programmed, the operator can set the switch to the "ON" position to prohibit anyone from changing the settings. With the switch in the "ON" position, the programming menus can still be accessed to view the current settings. However, no changes will be saved.

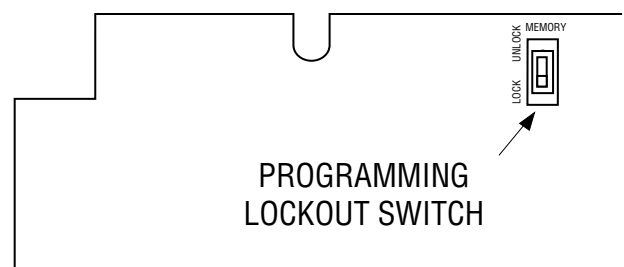

P3048

PROGRAMMING THE BREWER (cont.)

PROGRAMMING FUNCTIONS - FLOW CHART

PROGRAMMING FUNCTIONS - LEVEL 1

BREW LOCKO T?
 NO DONE YES
 BREW A BREW B BREW C

PROGRAMMING FUNCTIONS - LEVEL 2

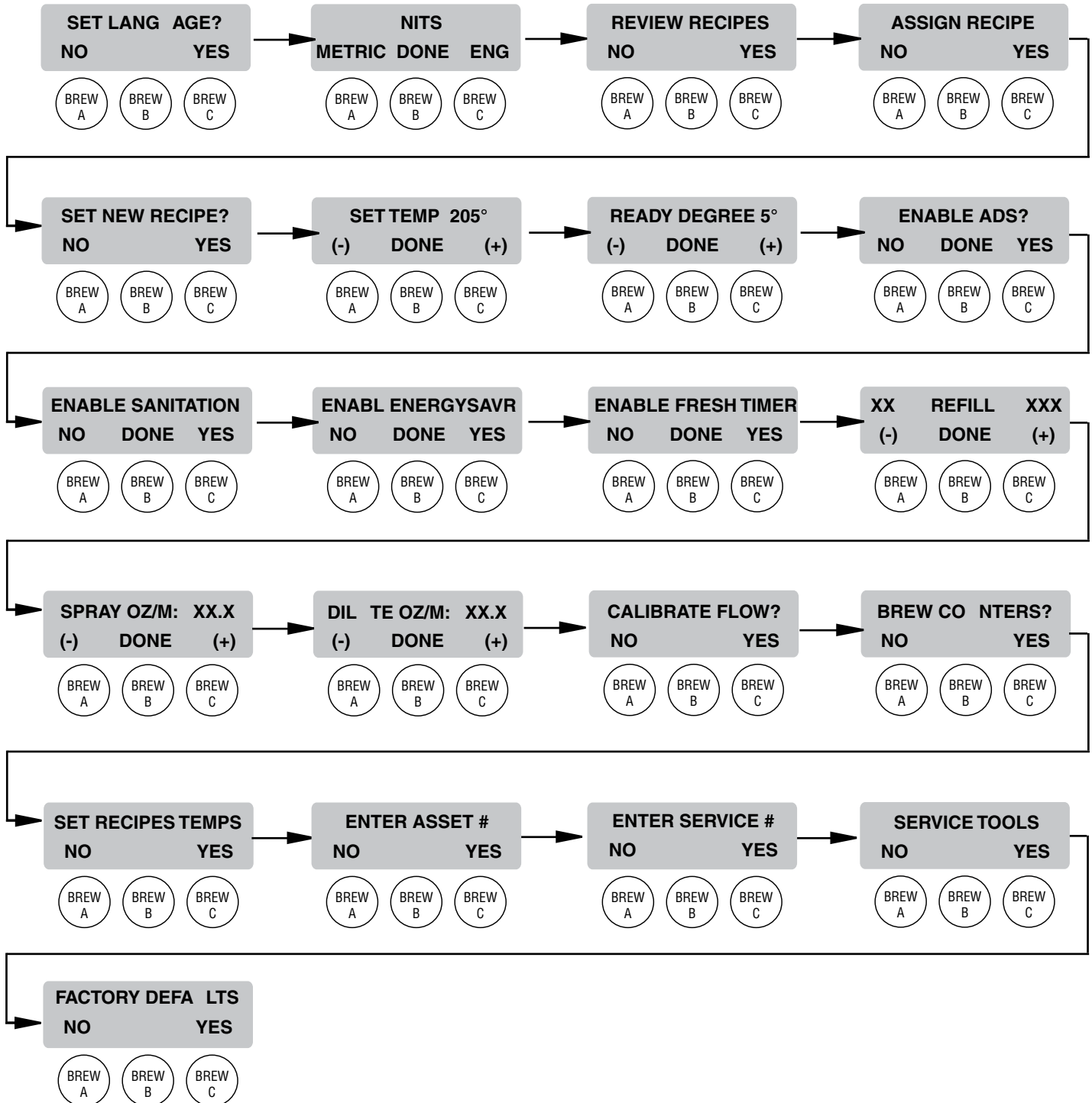

PROGRAMMING THE BREWER (cont.)

PROGRAMMING FUNCTIONS - LEVEL I

BREW LOCKOUT

This function allows the operator to prevent or allow brewing if the water temperature is less than the set **READY** temperature.

Procedure for setting Brew Lockout:

1. To access this function screen press and hold the right hidden button. Release when the display reads:

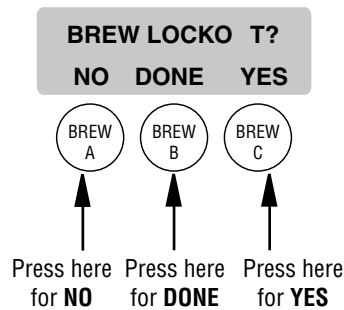

2. The **YES** or **NO** should be flashing. Select **YES** to prevent brewing if the water temperature is below the set **READY** temperature. Select **NO** to permit brewing at any water temperature.
3. When finished, press and release **DONE**. This will exit this function screen and return to the **MAIN SCREEN** on the display.

PROGRAMMING THE BREWER (cont.)

PROGRAMMING FUNCTIONS - LEVEL 2 (cont.)

The functions in the second level of programming allow the operator to adjust brew settings and other feature options.

To access the level 2 function screens press and hold the right hidden button. Release when the display reads:

SET LANGUAGE

This function allows the operator to select the language used for the display.

Procedure for setting Language:

1. Press and hold the right hidden button until the display reads **SET LANGUAGE?** and release.
2. Press **YES** to proceed. The display should now read **ENGLISH**. Using **(-)** and **(+)**, scroll through the available languages until the desired language is shown on the display.
3. When finished, press **DONE**. If the language selected is different from the current settings, the display will read **CHANGE LANGUAGE? ARE YOU SURE?** and then will change to **CHANGE LANGUAGE?** To convert the display to the new language, press **YES**. To retain the current language, press **NO**.
4. The display should now read **UNITS**. To exit programming and return to the **MAIN SCREEN**, press and release the ON/OFF button.

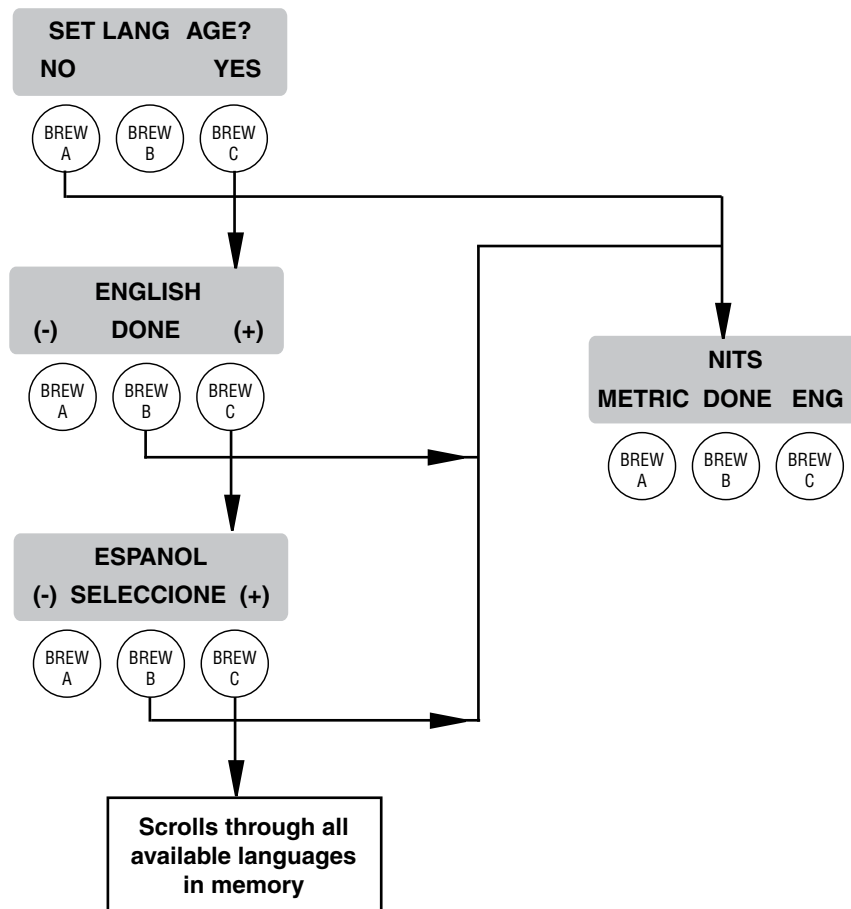

PROGRAMMING THE BREWER (cont.)

PROGRAMMING FUNCTIONS - LEVEL 2 (cont.)

UNITS

This function allows the operator to select if numeric settings are displayed in English or Metric units.

Procedure for setting the Units:

1. Press and hold the right hidden button until the display reads **SET LANGUAGE?** Press and release the right hidden button until the display reads **UNITS**. The **METRIC** or **ENG** should be flashing.
2. Select **METRIC** to have settings displayed in Metric units. Select **ENG** to have setting displayed in English units.

NOTE: Changing the **UNIT** settings will restore ALL settings to Factory Default.

3. When done, press and release **DONE** to retain your settings and advance to the next programming screen. To exit programming and return to the Main Screen, press and release the ON/OFF button.

NOTE: This manual is written based on Factory Default settings (English Units). If the brewer is set for Metric Units, display will be different. (ex: Brew oz will become Brew ml).



PROGRAMMING THE BREWER (cont.)

PROGRAMMING FUNCTIONS - LEVEL 2 (cont.)

REVIEW RECIPES (Modify recipe, set up standard recipes)

This function has three parts:

1. It allows the operator to view the brew settings for the various tea and coffee recipes stored into the brewer.
2. It allows the operator to modify (change) any of the brew settings for a particular recipe stored in the brewer.
3. It is used to set up the standard recipes for Tea, Hot Tea, Iced Coffee and No-Name Coffee.

Procedure for reviewing the recipes:

1. Press and hold the right hidden button until the display reads **SET LANGUAGE**. Press the right hidden button until the display reads **REVIEW RECIPES**. Press **YES**.
2. The display should now read **TEA 1**, along with **MODIFY SHOW** and **NEXT**.
3. Press and release **SHOW**. The screen will scroll through all the brew settings for that particular recipe. When finished, the display will return to the recipe name just viewed.
4. To see the settings again, press **SHOW**. To advance to the next recipe, press **NEXT**.

5. To exit, press **NEXT** until the display reads **THAT WAS THE LAST RECIPE**.
6. After 5 seconds, the display will return to the **REVIEW RECIPES** screen. Press and release **NO** to advance to the next function screen, or press and release the ON/OFF pad to exit the programming mode and return to the **MAIN SCREEN**.

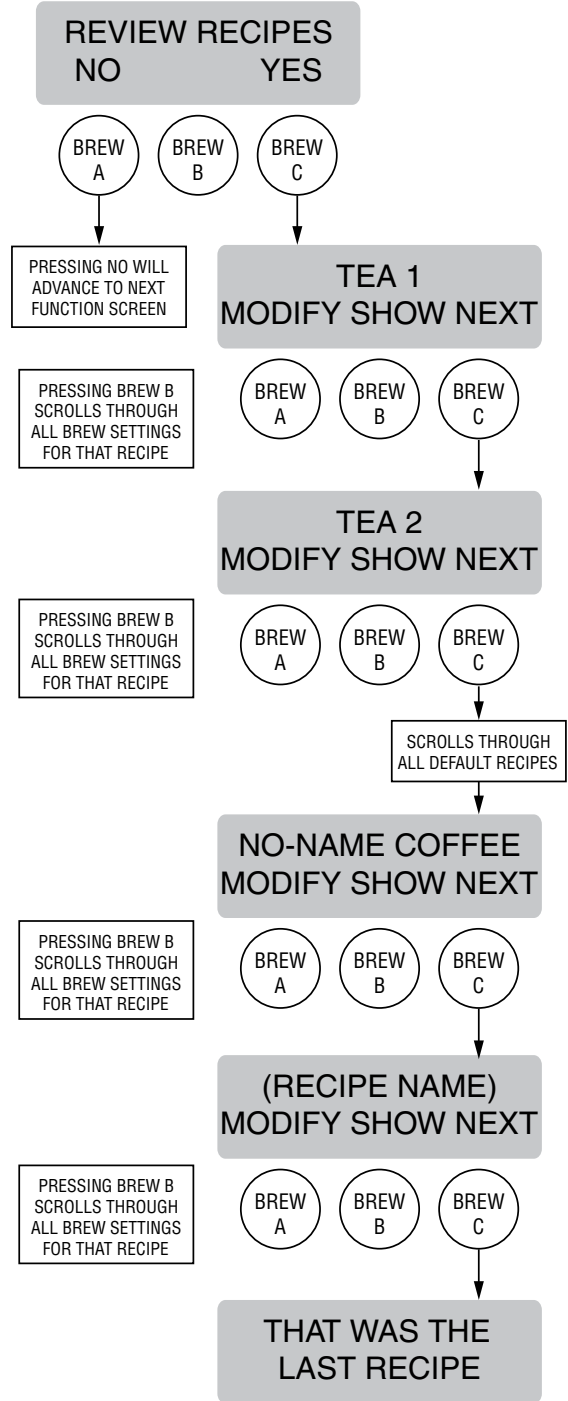
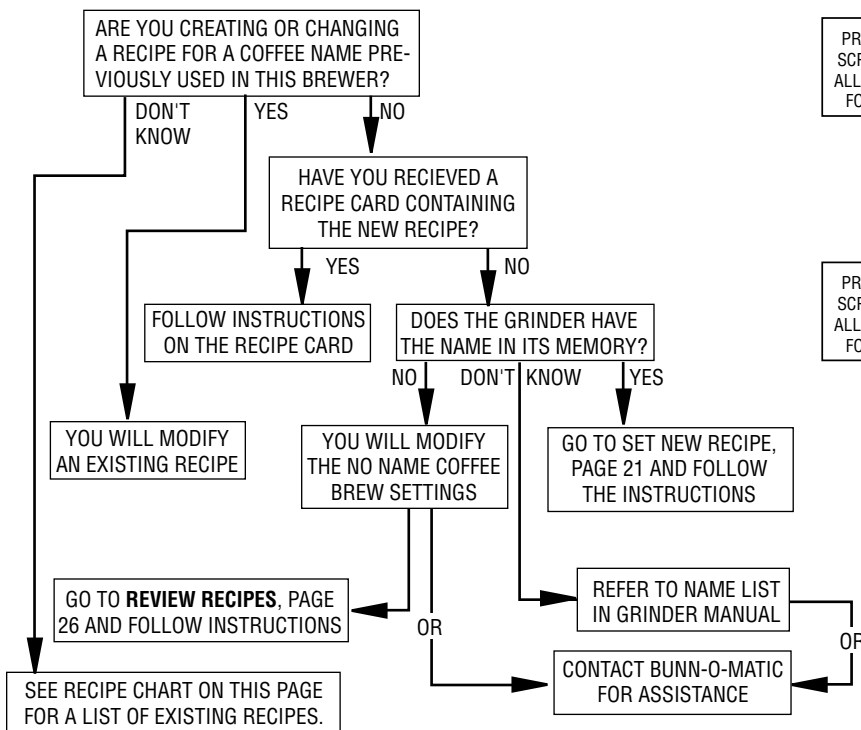

P2859

| RECIPE CHART | |
|--------------|----------------|
| Tea 1 | Iced Coffee |
| Tea 2 | No Name Coffee |
| Tea 3 | |
| Hot Tea | |
| | |
| | |

PROGRAMMING THE BREWER (cont.)

PROGRAMMING FUNCTIONS - LEVEL 2 (cont.)

ASSIGN RECIPE

This function allows the operator to assign recipes to the three brew buttons. Standard recipes (TEA 1, TEA 2, TEA 3, HOT TEA, ICED COFFEE, NO-NAME COFFEE) and any saved recipes from a Smart Funnel or Recipe Card can be assigned to a brew button. Only one recipe per brew button is allowed, for a total three recipes available to brew.

NOTE: Factory Defaults assign the TEA 1 recipe to Brew A, HOT TEA recipe to Brew B, and NO-NAME COFFEE to Brew C.

Procedure to select switch recipes:

1. Press and hold the right hidden button until the display reads **SET LANGUAGE**. Press the right hidden button until the display reads **SELECT SWITCH RECIPE?** Press **YES**.
2. The display should now read **SELECT RECIPE BREW SWITCH A**, and then **TEA 1**.
3. Using **(-)** and **(+)**, scroll through the stored recipes in the brewer's memory until the desired recipe name is reached.
4. Press and release **DONE** to set that recipe for brew button A.
5. The display should now read **SELECT RECIPE BREW SWITCH B**, and then **HOT TEA**.
6. Using **(-)** and **(+)**, scroll through the stored recipes in the brewer's memory until the desired recipe name is reached.
7. Press and release **DONE** to set that recipe for brew button B.
8. The display should now read **SELECT RECIPE BREW SWITCH C**, and then **NO-NAME COFFEE**.
9. Using **(-)** and **(+)**, scroll through the stored recipes in the brewer's memory until the desired recipe name is reached.
10. Press and release **DONE** to set that recipe for brew button C.
11. The display should now read **REVIEW RECIPES**.

Procedure to disable a Brew Switch:

1. Follow the same procedure as above. When selecting the recipe for the brew switch to be disabled, use **(-)** and **(+)** to scroll until the display reads **DISABLED**.

2. Press and release **DONE** to disable that brew switch on that side.

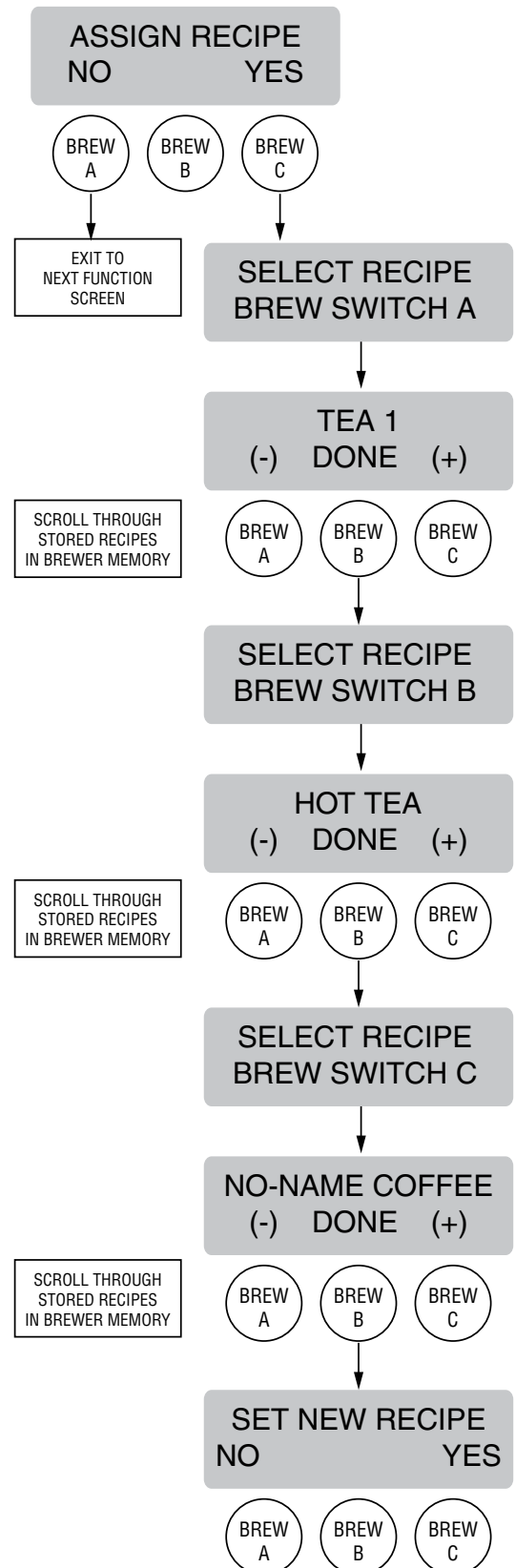

PROGRAMMING THE BREWER (cont.)

PROGRAMMING FUNCTIONS - LEVEL 2 (cont.)

SET NEW RECIPE (to set a new COFFEE recipe using a Smart Funnel or RECIPE CARD)

Using a Smart Funnel and a G9-2T DBC or MHG Grinder:

This function allows the operator to set **BREW VOLUMES, PULSE BREW TIMES AND DRIP OUT TIMES** for each coffee name preset in the grinder's memory.

Certain coffee names are stored in the grinder's memory. When a particular name of coffee is ground into the Smart Funnel, that name and the batch size selected are transferred from the grinder to the programming **CHIP** located in the funnel handle. The funnel is then inserted into the brewer's funnel rails. The **SENSING COIL** on the brewer reads the information contained in the handle. The name of the coffee flavor will then appear on the display. This allows the operator to set the **BREW VOLUME, PULSE BREW TIMES** and **DRIP OUT TIME** for that particular coffee name. It also allows the operator to set other brewing parameters, such as **BREW TEMPERATURE, BREW LOCKOUT**, etc. Each coffee name can be set individually to provide optimum brewing quality.

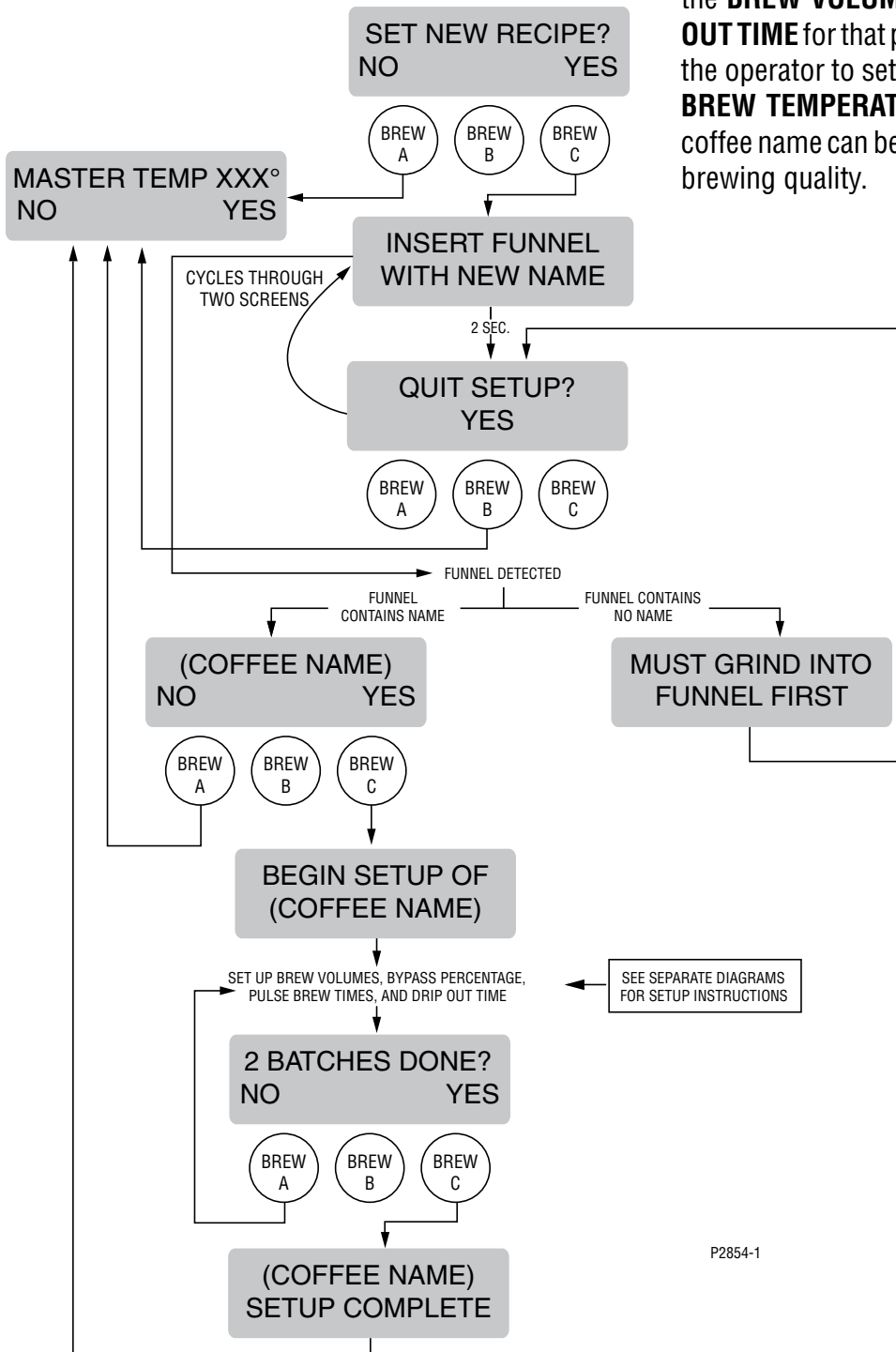

P2854-1

PROGRAMMING THE BREWER (cont.)

PROGRAMMING FUNCTIONS - LEVEL 2 (cont.)

Procedure for Setting the Recipe:

NOTE: Before beginning setup, place a server beneath the brew funnel.

1. Insert the funnel into the grinder and select the small batch size to grind. It is not necessary to have coffee beans in the hopper(s) in order to program the brewer. The coffee name is pre-selected and stored in the grinder's memory for the side being ground.
2. Press the GRIND pad. When the grinder stops grinding, remove the funnel.
3. On the brewer, press and hold the right hidden button until the display reads **SET LANGUAGE**. Press and release the right hidden button until the display reads **SET NEW RECIPE**. Release the right hidden button.
4. Press and release **YES**. The display should read **INSERT FUNNEL WITH NEW NAME**, then **QUIT SETUP?** These two displays will repeatedly cycle.
5. Insert the funnel into the rails on the brewer. The display should read the name of the coffee that was ground into the funnel, along with a **NO** and **YES**. If the name on the display is correct, press **YES**.
6. If, for some reason, the name of the coffee from the grinder did not load properly into the funnel, or if a grind has not yet been done, the display will read **MUST GRIND INTO FUNNEL FIRST**. It will be necessary to grind another batch following steps 1 and 2.

NOTE: If brewer memory is full, the display will read **RECIPE STORAGE AREA IS FULL** and then **REMOVE A FLAVOR?** To remove a recipe press and release **YES**. Press **NEXT** to scroll through the stored recipes. When the display reads the name of the recipe to be removed, press and release **REMOVE**. The display will read **REMOVE?** Press **CANCEL** to exit the **SET NEW RECIPE** function. Press **OK** to remove that recipe. The display will then show **BEGIN SETUP OF (COFFEE NAME)**. Continue with step 7.

7. If the grind is acknowledged by the brewer, the display will read **BEGIN SETUP OF (COFFEE NAME)**. Then the screen will display **BREW OZ** and a batch light will be blinking. (Refer to page 34 for description of **BREW OZ** function).
8. Using **(-)** and **(+)**, set the amount of brew water to be dispensed for that batch size.

9. When finished, press the other batch size and repeat step #8.
10. When finished setting both batch sizes, press and release **DONE**. The display should read **2 BATCHES DONE?**
11. If both batch sizes are not correct press and release **NO** to return to the **BREW OZ** setup screen and repeat steps #8, 9 and 10.
12. If both batch sizes are correct, press and release **YES** to advance to the **SET PULSE BREW** function. (Refer to page 35 for description of the **SET PULSE BREW** function).
13. To **SET PULSE BREW** press **YES** and proceed with the setup instructions for *SETTING PULSE BREW*, on page 35.
14. To skip setting the **PULSE BREW** and to use the **FACTORY DEFAULTS**, press **NO** to proceed to the **DRIP TIMES** function.

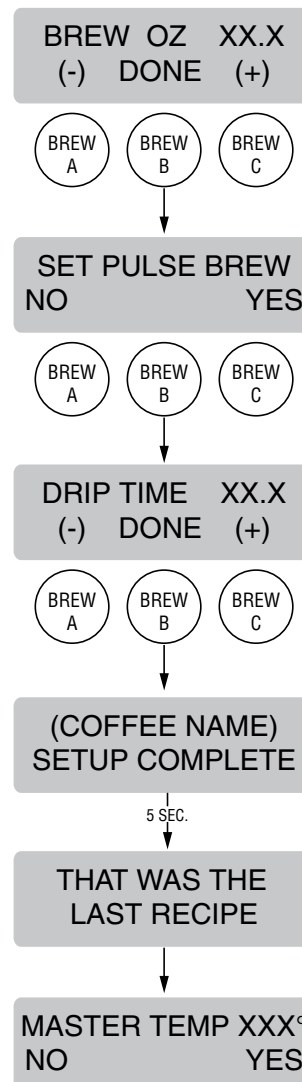

P2855

PROGRAMMING THE BREWER (cont.)

PROGRAMMING FUNCTIONS - LEVEL 2 (cont.)

15. The display should now read **DRIP TIME**, along with either the word **OFF** or a time showing. A batch light will also be blinking.
16. Using **(-)** and **(+)**, set the amount of time from when the brew spray ends to when the funnel is emptied of hot liquid.
17. When finished, press the other batch size and repeat step #16
18. When finished setting both batch sizes, press **DONE**. The display should read **2 BATCHES DONE?**
19. Press and release **YES**. The screen should show the name of the coffee being programmed (modified) along with **SETUP COMPLETE**.
20. After a 5 second delay, the display will advance to the next coffee name in the brewer's memory. If no other coffee names are present, the display will read **THAT WAS THE LAST RECIPE**, and advance to the **MASTER TEMP** screen.

SET NEW RECIPE

Using a **RECIPE CARD** to load coffee names and brew settings

The G9-2T DBC or MHG Grinder's memory contains certain coffee names. If the operator uses a coffee name that is not already stored in the grinder's memory, a **RECIPE CARD** can be obtained from the factory. The **RECIPE CARD** would include all the information needed to set up that particular coffee name. The information from the **RECIPE CARD** is loaded into the grinder's memory, then into the brewer's memory by holding the chip area up to the equipment's **SENSING COIL**. This information can include the coffee name, **BREW VOLUMES**, **PULSE BREW TIMES** and **DRIP OUT TIME** for that particular coffee name. These can all be loaded in seconds.

Contact Bunn-O-Matic Corporation for the availability of **RECIPE CARDS**.

NOTE: Instructions to program the brewer and grinder are printed on the **RECIPE CARD**, along with the coffee name that is being programmed.

Procedure to program the coffee name:

1. Remove the funnel (if present) from the funnel rails.

2. Position the **RECIPE CARD** vertically, so that the top end of the **CHIP** is beneath the **SENSING COIL** (located on the middle of the underneath side of the front display panel).
3. After a short pause the display will read **CARD CONTAINS RECIPE FOR** then will change to **(COFFEE NAME) SHOW QUIT SAVE**. All brewing parameters for that coffee flavor are now transferred from the **CARD** to the brewer.

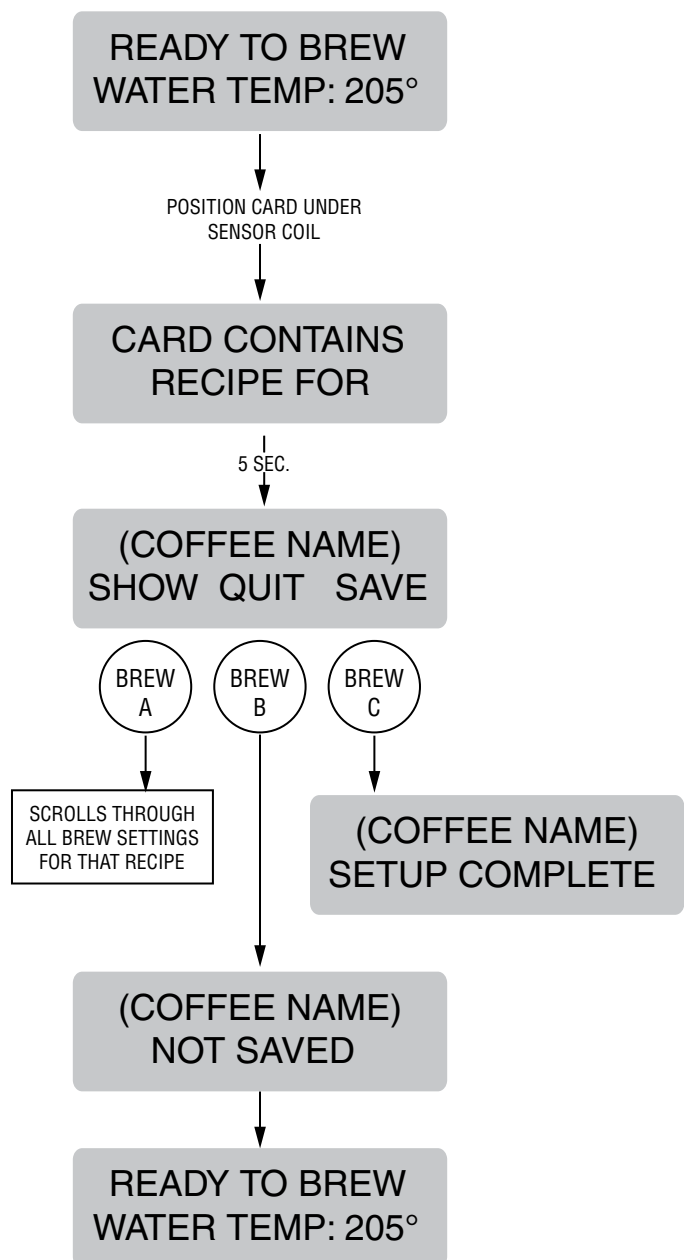

P2856

PROGRAMMING THE BREWER (cont.)

PROGRAMMING FUNCTIONS - LEVEL 2 (cont.)

- To show (view) this information, press and release **SHOW**. The display will scroll through all of the brew settings for that recipe. This display will then return to **CARD CONTAINS RECIPE FOR** then will change to **(COFFEE NAME) SHOW QUIT SAVE**.
- If all brew settings are correct, press **SAVE**. The display will read **(COFFEE NAME) SETUP COMPLETE**. All brew settings for that name are now stored in the brewer's memory.
- If the brewing information is not correct, or it is desired to exit the setup before the settings are loaded into the brewer's memory, press **QUIT**. The display will read **(COFFEE NAME) NOT SAVED**. The display will then return to the **MAIN SCREEN**.

SET NEW RECIPE

If not using a Smart Funnel and/or a G9-2T DBC or MGH Grinder and/or a Recipe Card

It is possible to operate the brewer without using a Smart Funnel and/or G9-2T DBC or MGH Grinder. If a standard funnel or if a non-DBC grinder is used the brewer will automatically select the recipe assigned to that brew button. This means that no name was read from the funnel's handle.

For instructions on programming the **NO-NAME COFFEE** settings, refer to the **REVIEW RECIPES** function on page 34. The same steps are followed for setting the **NO-NAME COFFEE** recipe as those that are used to modify a recipe. Note that when the display reads **NO-NAME COFFEE**, that is when **MODIFY** should be pressed in order to set the parameters.

NOTE: Before beginning setup, insert a funnel into the funnel rails and place a server or dispenser beneath the brew funnel.

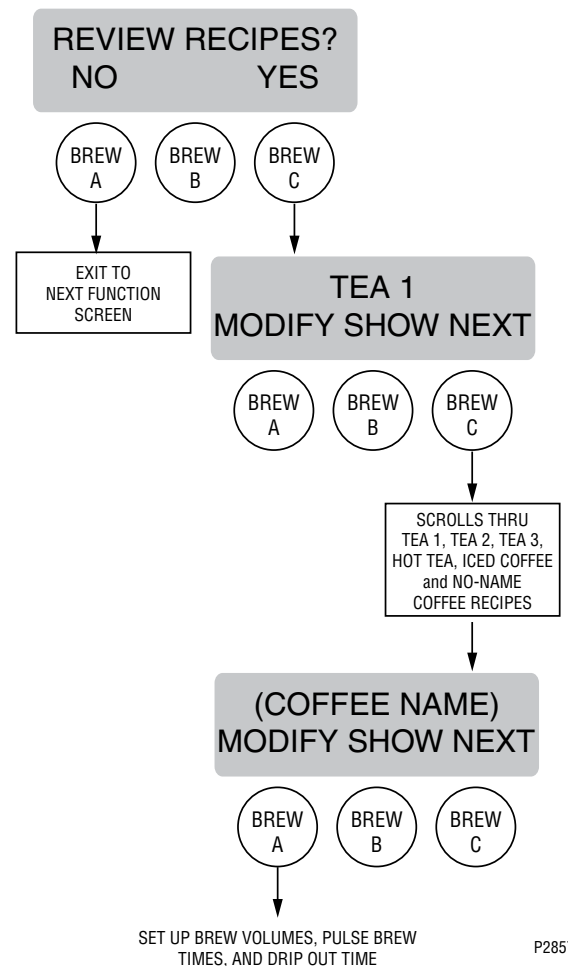

PROGRAMMING THE BREWER (cont.)

PROGRAMMING FUNCTIONS - LEVEL 2 (cont.)

Procedure for modifying TEA recipes:

Tea recipes: BREW OZ:

Range: **OFF, 10.0 oz to 135.0 oz (.3-4.0 L)** for both batch sizes

This function allows adjustment of the brew (tea concentrate) volumes for each batch.

1. Press and hold the right hidden button until the display reads **SET LANGUAGE**. Press the right hidden button until the display reads **REVIEW RECIPES**.
2. Press **YES** to proceed. The display should now read **TEA 1**, along with **MODIFY SHOW NEXT**.
3. Press and release **NEXT** to advance to the desired recipe to be modified.
4. Press and release **MODIFY**. The display should read **BREW OZ:** and a batch light will be blinking. Press and release the batch size to be modified.
5. Using **(-)** and **(+)**, set the amount of brew water to be dispensed **over** the tea leaves for that particular batch size.
6. When finished, press the other batch size and repeat step #5.
7. When finished setting both batch sizes, press and release **DONE**. The display should read **2 BATCHES DONE?**
8. If both batch sizes are not correct, press and release **NO** to return to the **BREW OZ:** setup screen and repeat steps #5, 6, and 7.
9. If both batch sizes are correct, press **YES**. This will advance to the **DILUTE OZ:** function. To exit to the **MAIN SCREEN**, press and release the ON/OFF button.

Procedure to disable a batch size:

1. Follow same procedure as above. Select the batch size to be disabled.
2. Using **(-)** and **(+)**, scroll until the display reads **BREW OZ OFF**.
3. Press and release **DONE**. This will disable this batch size for that recipe.

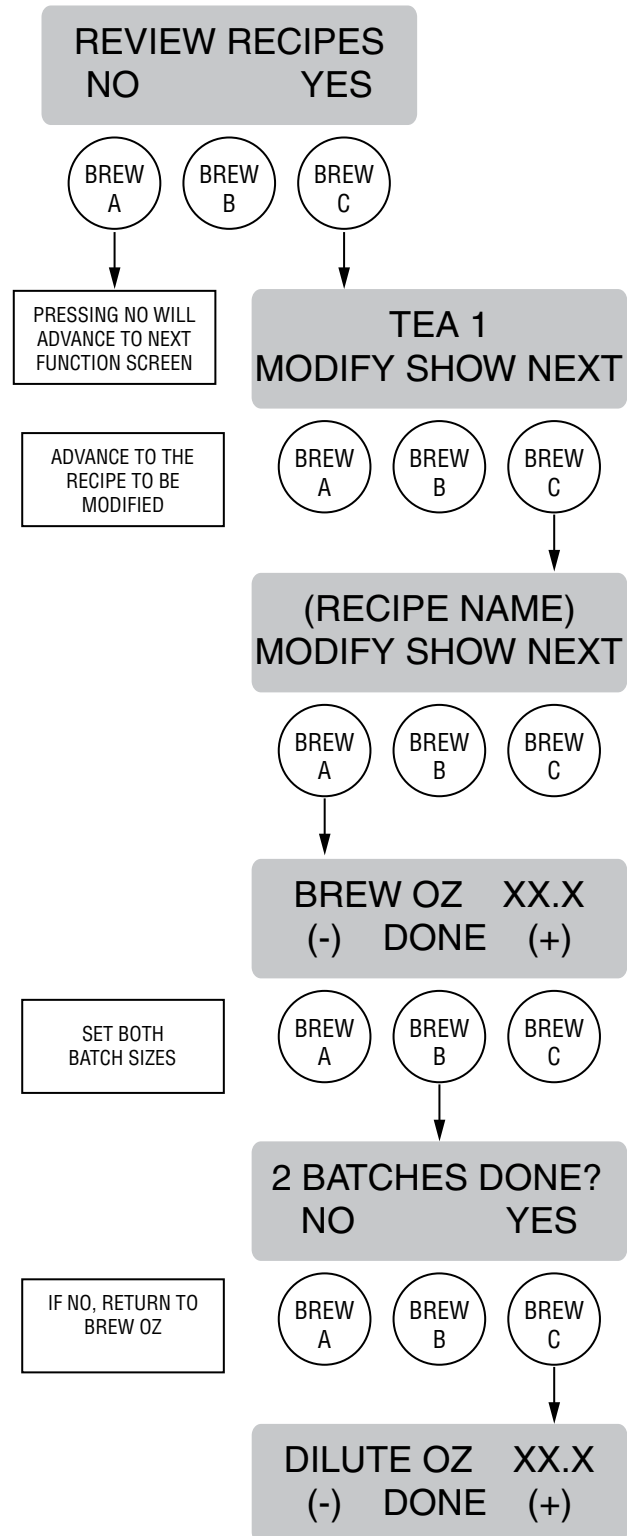

P2860

PROGRAMMING THE BREWER (cont.)

PROGRAMMING FUNCTIONS - LEVEL 2 (cont.)

Tea recipes: **DILUTE OZ:**

Range: **0.0 oz to 580.0 oz (0-17.1 L)** for both batch sizes

This function allows adjustment of the dilution volumes for each batch.

NOTE: If the brewer is already on the **DILUTE OZ:** screen, skip steps 1 through 6, and proceed directly to step 7.

1. Press and hold the right hidden button until the display reads **SET LANGUAGE**. Press the right hidden button until the display reads **REVIEW RECIPES**.
2. Press **YES** to proceed. The display should now read **TEA 1**, along with **MODIFY SHOW NEXT**.
3. Press and release **NEXT** to advance to the desired recipe to be modified.
4. Press and release **MODIFY**. The display should read **BREW OZ:**
5. Press and release **DONE**. The display should read **2 BATCHES DONE?**
6. Press and release **YES**. The display should now read **DILUTE OZ:** and a batch light will be blinking. Press and release the batch size to be modified.
7. Using **(-)** and **(+)**, set the amount of dilution water for that particular batch size to be dispensed through the nozzle into the tea dispenser.
8. When finished, press the other batch size and repeat step # 7.
9. When finished setting both batch sizes, press and release **DONE**. The display should read **2 BATCHES DONE?**
10. If both batch sizes are not correct, press and release **NO** to return to the **DILUTE OZ:** setup screen and repeat steps 7, 8 and 9.
11. If both batch sizes are correct, press **YES**. This will advance to the **DILUTE DELY** function. To exit to the **MAIN SCREEN**, press and release the ON/OFF button.

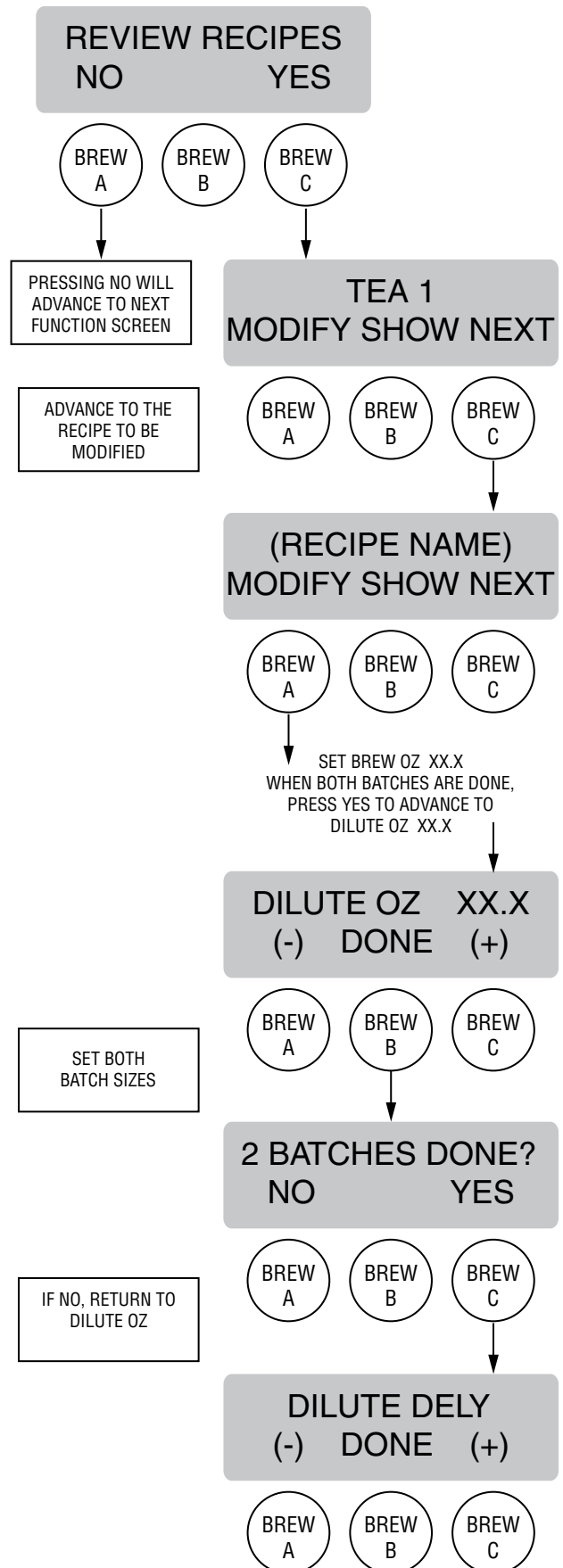

P2861

PROGRAMMING THE BREWER (cont.)

PROGRAMMING FUNCTIONS - LEVEL 2 (cont.)

Tea recipes: DILUTE DELAY

Range: OFF to 10 minutes for both batch sizes

This function allows the operator to adjust the timing for the start of the dilution water. The **OFF** setting will begin dilution flow immediately after the brew button is pressed (simultaneously with the brew water). If a time is set for Dilution Delay, the dilution water dispense will be delayed for that set time after the brew button is pressed and the brew started.

NOTE: If the brewer is already on the **DILUTE DELY** screen, skip steps 1 through 8, and proceed directly to step 9.

1. Press and hold the right hidden button until the display reads **SET LANGUAGE**. Press the right hidden button until the display reads **REVIEW RECIPES**.
2. Press **YES** to proceed. The display should now read **TEA 1**, along with **MODIFY SHOW NEXT**.
3. Press and release **NEXT** to advance to the desired tea recipe to be modified.
4. Press and release **MODIFY**. The display should read **BREW OZ:**
5. Press and release **DONE**. The display should read **2 BATCHES DONE?**
6. Press and release **YES**. The display should now read **DILUTE OZ:**
7. Press and release **DONE**. The display should read **2 BATCHES DONE?**
8. Press and release **YES**. The display should now read **DILUTE DELY:** and a batch light will be blinking. Press and release the batch size to be modified.
9. Using **(-)** and **(+)**, set the time delay for the dilution water for that particular batch size.
10. When finished, press the other batch size and repeat step # 9.
11. When finished setting both batch sizes, press and release **DONE**. The display should read **2 BATCHES DONE?**
12. If both batch sizes are not correct, press and release **NO** to return to the **DILUTE DELY** setup screen and repeat steps 9, 10 and 11.
13. If both batch sizes are correct, press **YES**. The display should now show the Brew Oz, Dilution Oz, and Dilution Delay setting for the batch size just programmed. After a 5 second delay, the display will read **SET PULSE BREW**. To exit to the **MAIN SCREEN**, press and release the ON/OFF button.

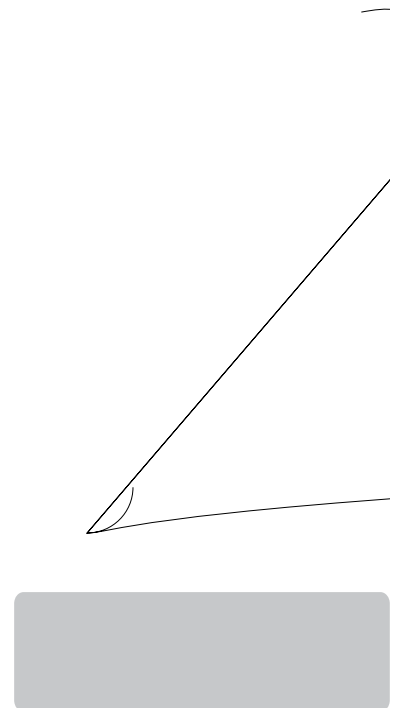

PROGRAMMING THE BREWER (cont.)

PROGRAMMING FUNCTIONS - LEVEL 2 (cont.)

TEA RECIPES:

SET PULSE BREW

This function allows the operator to program the brewer to “pulse” the sprayhead flow on and off during a brew cycle (start and stop the flow of water out of the sprayhead). This feature allows the ability to “fine-tune” the brewer for specific flavor profiles. Pulse brewing can be set up for any and all batch sizes.

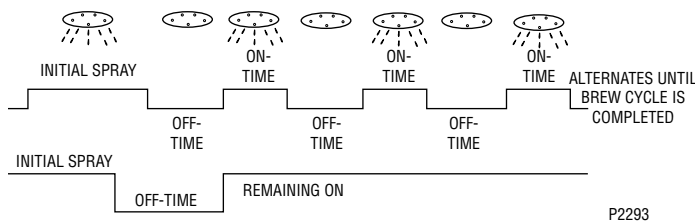

- a) 1st ON TIME** – This time is the duration from when the brew button is pressed to when the desired water level in the funnel is reached. (Soaking the tea leaves)
- b) OFF-TIME** – This time is the duration from when the water in the funnel reaches the desired **ON TIME** to when it drains out of the funnel to a desired lower level.
- c) LAST ON-TIME** – This time is the duration from when the water in the funnel drains down to the lower level to when it fills the funnel to a desired higher level. (Soaking the tea leaves)

These three times can be set two different ways. The first is by setting the total brew time and using a calculated pulse routine. This is done by utilizing the **EASY PULSE BREW** screen and following the setup for that function.

Setting Pulse Brew – EASY Pulse Brew

Range: Minimum: will adjust to the minimum time required to brew that batch using the set brew volumes and flow rate for the sprayhead. Maximum – will adjust depending on settings. Will always be minimum time + 3 minutes. The brewer will automatically calculate what the **1ST ON TIME**, **OFF TIMES**, and **LAST ON TIME** will be using the initial on time, plus a 7 pulse routine.

The other option allows the actual times to be entered for each of the settings. This is done by utilizing the **MANUAL PULSE BREW** screen and following the subsequent steps under that function.

Setting Pulse Brew – MANUAL Pulse Brew

- Range:** **1ST ON TIME** – off to 1 minute
- OFF TIME** – off to 20 seconds
- LAST ON TIME** – Pre-Infusion to 1 minute

PROGRAMMING THE BREWER (cont.)

PROGRAMMING FUNCTIONS - LEVEL 2 (cont.)

Setting Pulse Brew – EASY Pulse Brew

NOTE: If the brewer is already on the **SET PULSE BREW** screen, skip steps 1 through 9, and proceed directly to step 10.

1. Press and hold the right hidden button until the display reads **SET LANGUAGE**. Press the right hidden button until the display reads **REVIEW RECIPES**.
2. Press **YES** to proceed. The display should now read **TEA 1**, along with **MODIFY SHOW NEXT**.
3. Press and release **NEXT** to advance to the desired recipe to be modified.
4. Press and release **MODIFY**. The display should read **BREW OZ:**
5. Press and release **DONE**. The display should read **2 BATCHES DONE?**
6. Press and release **YES**. The display should now read **DILUTE OZ:**
7. Press and release **DONE**. The display should read **2 BATCHES DONE?**
8. Press and release **YES**. The display should now read **DILUTE DELY:**
9. Press and release **DONE**. The display should now show the Brew Oz, Dilution Oz, and Dilution Delay setting for the batch size just programmed. After a 5 second delay, the display will read **SET PULSE BREW**.
10. Press and release **YES**. The display should now read **SELECT METHOD**.
11. Press and release **EASY**. With EASY flashing, press and release **NEXT** to advance.
12. The display should now read **BREW TIME:** and a batch light will be blinking. Press and release the batch size to be modified.
13. Using **(-)** and **(+)**, set the total brew time desired including spray times and off times.
14. When finished, press the other batch size and repeat step # 13.
15. When finished setting both batch sizes, press and release **DONE**. The display will show the pulse settings to accommodate the brew time entered. Press and release each batch size to display the settings for that batch. After a delay, the display should read **2 BATCHES DONE?**
16. If both batch sizes are not correct, press and release **NO** to return to the **BREW TIME** setup screen and repeat steps 13, 14 and 15.

17. If both batch sizes are correct, press **YES**. The display should now read **DRIP TIME:**. To exit to the **MAIN SCREEN**, press and release the ON/OFF button.

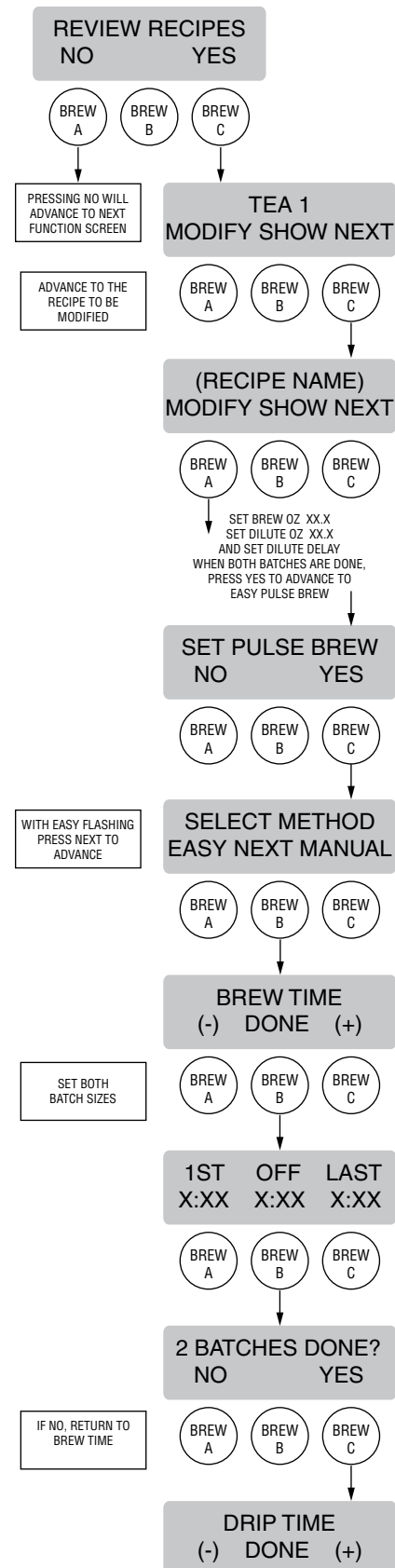

PROGRAMMING THE BREWER (cont.)

PROGRAMMING FUNCTIONS - LEVEL 2 (cont.)

Setting Pulse Brew – MANUAL Pulse Brew

NOTE: If the brewer is already on the **SET PULSE BREW** screen, skip steps 1 through 9, and proceed directly to step 10.

1. Press and hold the right hidden button until the display reads **SET LANGUAGE**. Press the right hidden button until the display reads **REVIEW RECIPES**.
 2. Press **YES** to proceed. The display should now read **TEA 1**, along with **MODIFY SHOW NEXT**.
 3. Press and release **NEXT** to advance to the desired recipe to be modified.
 4. Press and release **MODIFY**. The display should read **BREW OZ:**
 5. Press and release **DONE**. The display should read **2 BATCHES DONE?**
 6. Press and release **YES**. The display should now read **DILUTE OZ:**
 7. Press and release **DONE**. The display should read **2 BATCHES DONE?**
 8. Press and release **YES**. The display should now read **DILUTE DELY:**
 9. Press and release **DONE**. The display should now show the Brew Oz, Dilution Oz, and Dilution Delay setting for the batch size just programmed. After a 5 second delay, the display will read **SET PULSE BREW**.
 10. Press and release **YES**. The display should now read **SELECT METHOD**.
 11. Press and release **MANUAL**. With **MANUAL** flashing, press and release **NEXT**.
 12. The display should now read **1st ON TIME** and a batch light will be blinking. Press and release the batch size to be modified.
 13. Using **(-)** and **(+)**, adjust the **1st ON TIME**.
 14. When finished, press the other batch size and repeat step # 13.
- NOTE:** To disable pulse brew, set **1st ON TIME** to OFF. Brewer will automatically pulse on tea recipes with a brew volume greater than 86.0 oz.
15. When finished setting both batch sizes, press and release **DONE**.
 16. The display should now read **OFF TIME**. Adjust the

PROGRAMMING THE BREWER (cont.)

PROGRAMMING FUNCTIONS - LEVEL 2 (cont.)

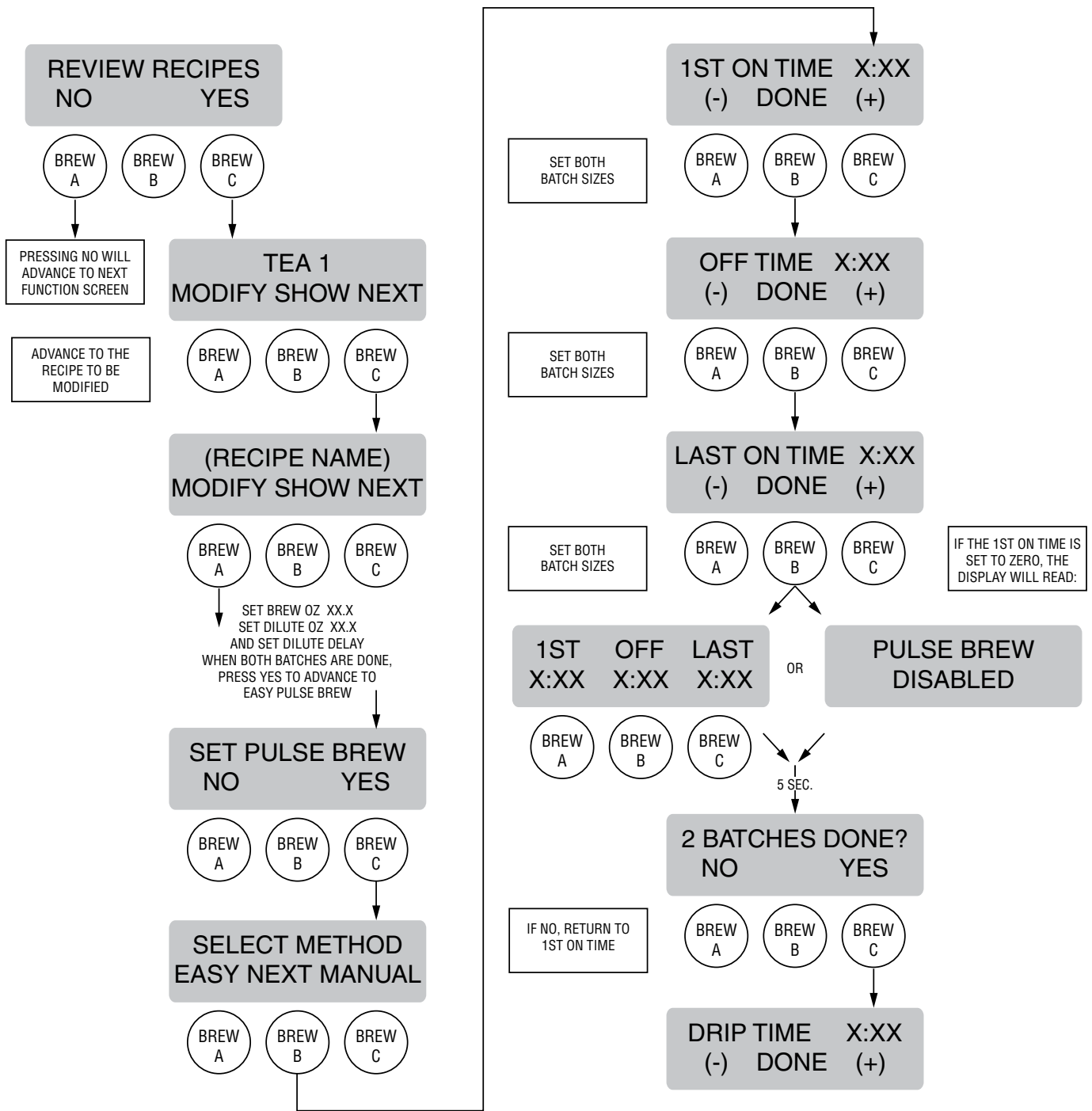

PROGRAMMING THE BREWER (cont.)

PROGRAMMING FUNCTIONS - LEVEL 2 (cont.)

TEA RECIPES:

DRIP TIME

This function allows the operator to adjust the **DRIP TIME** (time from end of sprayhead flow to when liquid stops dripping from the funnel). When the brew cycle is complete, the display will show **DRIPPING** and will countdown the time until the funnel empties.

Setting DRIP TIME:

Range: **OFF to 5 minutes for all batch sizes.**

NOTE: If the brewer is already in the **DRIP TIME** screen, skip steps 1 through 10 and proceed directly to step 11.

1. Press and hold the right hidden button until the display reads **SET LANGUAGE**. Press the right hidden button until the display reads **REVIEW RECIPES**.
2. Press **YES** to proceed. The display should now read **TEA 1**, along with **MODIFY SHOW NEXT**.
3. Press and release **NEXT** to advance to the desired recipe to be modified.
4. Press and release **MODIFY**. The display should read **BREW OZ:**
5. Press and release **DONE**. The display should read **2 BATCHES DONE?**
6. Press and release **YES**. The display should now read **DILUTE OZ:**
7. Press and release **DONE**. The display should read **2 BATCHES DONE?**
8. Press and release **YES**. The display should now read **DILUTE DELY:**
9. Press and release **DONE**. The display should now show the Brew Oz, Dilution Oz, and Dilution Delay setting for the batch size just programmed. After a 5 second delay, the display will read **SET PULSE BREW**.
10. Press and release **NO**. The display should now read **DRIP TIME** and a batch light should be flashing.
11. Using the **(-)** and **(+)**, set the amount of time from when the brew solenoid shuts off to when drip-out occurs for that batch size.
12. When finished, press the other batch size and repeat step 11.
13. When finished, press **DONE**. The display should read **2 BATCHES DONE?**

14. If both batch sizes are not correct, press and release **NO** to return to the **DRIP TIME** setup screen and repeat steps 11 through 13.
15. If both batch sizes are correct, press **YES**. The display should show the name of the recipe being programmed (modified) along with **SETUP COMPLETE**. After a 5 second delay, the display will advance to the next recipe name in the brewer's memory. To exit to the **MAIN SCREEN**, press and release the ON/OFF button.

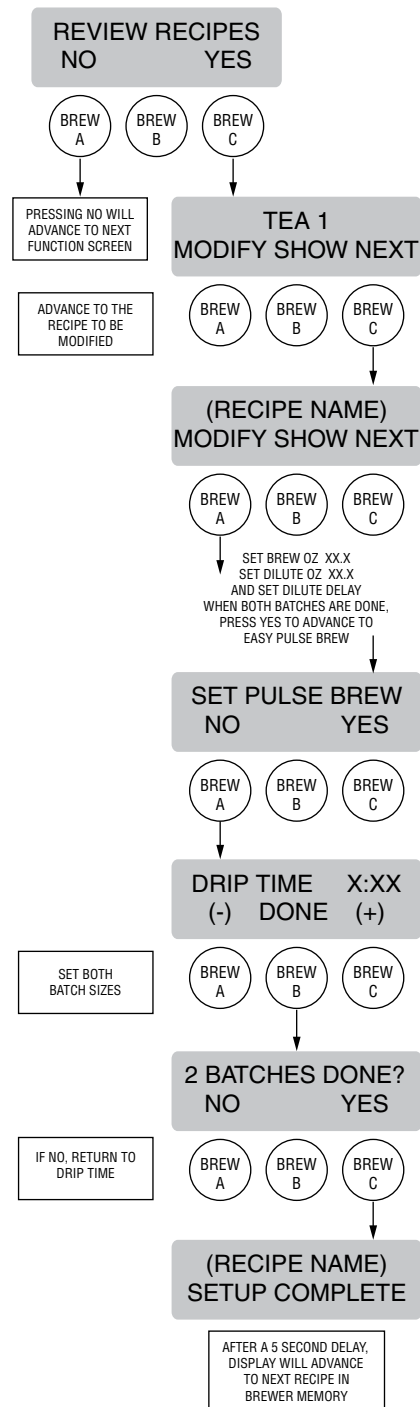

P2865

PROGRAMMING THE BREWER (cont.)

PROGRAMMING FUNCTIONS - LEVEL 2 (cont.)

Procedure for modifying COFFEE recipes:

Coffee recipes: BREW OZ:

Range: OFF 10.0 oz to 135.0 oz (0.0-4.0L) for both batch sizes

This function allows adjustment of the brew volumes for each batch.

1. Press and hold the right hidden button until the display reads **SET LANGUAGE**. Press the right hidden button until the display reads **REVIEW RECIPES**.
2. Press **YES** to proceed. The display should now read **TEA 1**, along with **MODIFY SHOW NEXT**.
3. Press and release **NEXT** to advance to the desired coffee recipe to be modified.
4. Press and release **MODIFY**. The display should read **BREW OZ:** and a batch light will be blinking. Press and release the batch size to be modified.
5. Using **(-)** and **(+)**, set the amount of brew water to be dispensed **over** the grounds for that particular batch size.
6. When finished, press the other batch size and repeat step #5.
7. When finished setting both batch sizes, press and release **DONE**. The display should read **2 BATCHES DONE?**
8. If both batch sizes are not correct, press and release **NO** to return to the **BREW OZ:** setup screen and repeat steps #5, 6, and 7.
9. If both batch sizes are correct, press **YES**. This will advance to **SET PULSE BREW**. To exit to the **MAIN SCREEN**, press and release the ON/OFF button.

Procedure to disable a batch size:

1. Follow same procedure as above. Select the batch size to be disabled.
2. Using **(-)** and **(+)**, scroll until the display reads **BREW OZ OFF**.
3. Press and release **DONE**. This will disable this batch size for that recipe.

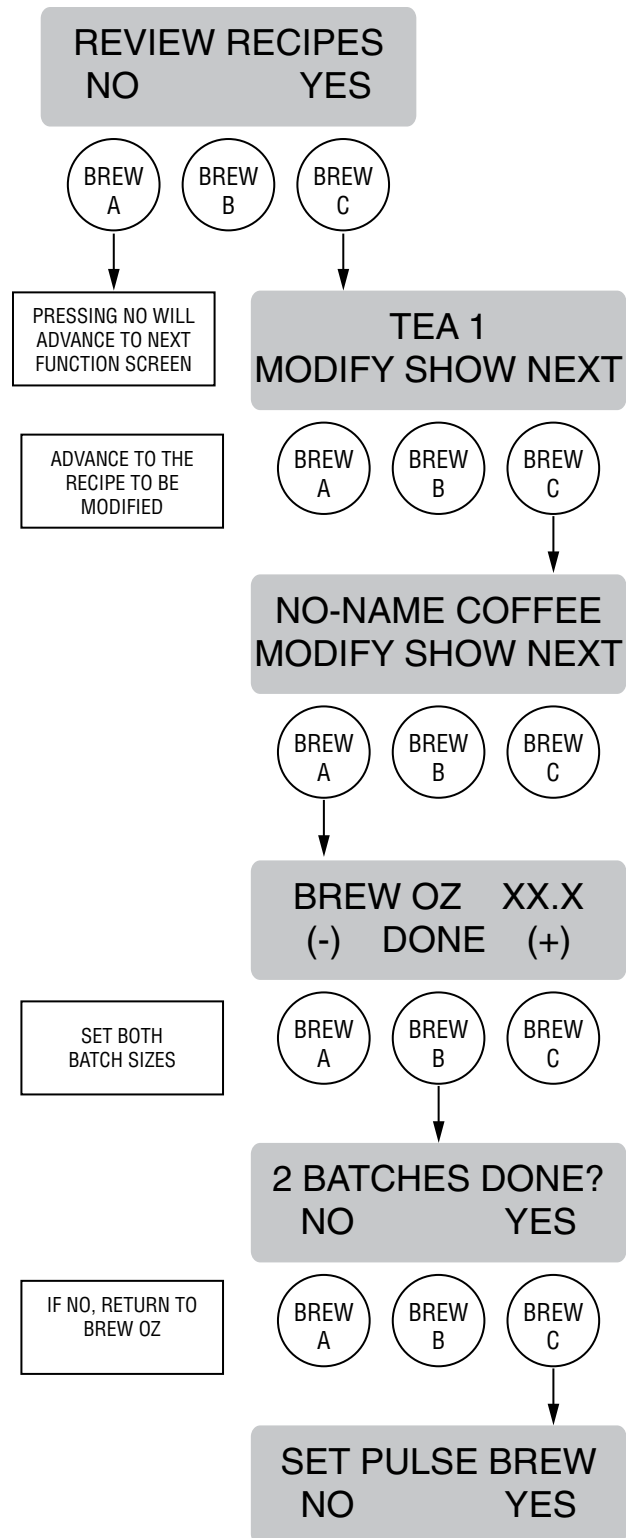

P2866

PROGRAMMING THE BREWER (cont.)

PROGRAMMING FUNCTIONS - LEVEL 2 (cont.)

COFFEE RECIPES: SET PULSE BREW

This function allows the operator to program the brewer to “pulse” the sprayhead flow on and off during a brew cycle (start and stop the flow of water out of the sprayhead). This feature allows the ability to “fine-tune” the brewer for specific flavor profiles. Pulse brewing can be set up for any and all batch sizes.

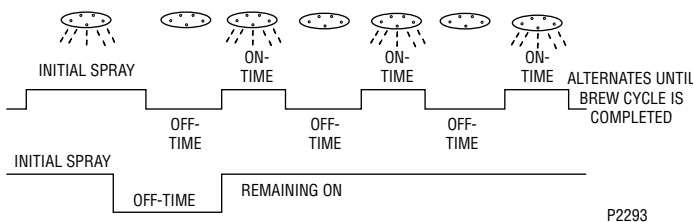

- a) **1st ON TIME** – This time is the duration from when the brew button is pressed to when the desired water level in the funnel is reached. (Soaking the grounds)
- b) **OFF-TIME** – This time is the duration from when the water in the funnel reaches the desired **ON TIME** to when it drains out of the funnel to a desired lower level.
- c) **LAST ON-TIME** – This time is the duration from when the water in the funnel drains down to the lower level to when it fills the funnel to a desired higher level. (Soaking the grounds)

These three times can be set two different ways. The first is by setting the total brew time and using a calculated pulse routine. This is done by utilizing the **EASY PULSE BREW** screen and following the setup for that function.

Setting Pulse Brew – EASY Pulse Brew

Range: Minimum: will adjust to the minimum time required to brew that batch using the set brew volumes and flow rate for the sprayhead. **Maximum** – will adjust depending on settings. Will always be minimum time + 3 minutes. The brewer will automatically calculate what the **1ST ON TIME**, **OFF TIMES**, and **LAST ON TIME** will be using the initial on time, plus a 7 pulse routine.

The other option allows the actual times to be entered for each of the settings. This is done by utilizing the **MANUAL PULSE BREW** screen and following the subsequent steps under that function.

Setting Pulse Brew – MANUAL Pulse Brew

Range: 1ST ON TIME – OFF to 4 minutes
OFF TIME – OFF to 4 minutes
LAST ON TIME – Pre-Infusion to 4 minutes

PROGRAMMING THE BREWER (cont.)

PROGRAMMING FUNCTIONS - LEVEL 2 (cont.)

Setting Pulse Brew – EASY Pulse Brew

NOTE: If the brewer is already on the **SET PULSE BREW** screen, skip steps 1 through 6, and proceed directly to step 7.

1. Press and hold the right hidden button until the display reads **SET LANGUAGE**. Press the right hidden button until the display reads **REVIEW RECIPES**.
2. Press **YES** to proceed. The display should now read **TEA 1**, along with **MODIFY SHOW NEXT**.
3. Press and release **NEXT** to advance to the desired coffee recipe to be modified.
4. Press and release **MODIFY**. The display should read **BREW OZ:**
5. Press and release **DONE**. The display should read **2 BATCHES DONE?**
6. Press and release **YES**. The display should now read **SET PULSE BREW**.
7. Press and release **YES**. The display should now read **SELECT METHOD**.
8. Press and release **EASY**. With EASY flashing, press and release **NEXT** to advance.
9. The display should now read **BREW TIME:** and a batch light will be blinking. Press and release the batch size to be modified.
10. Using **(-)** and **(+)**, set the total brew time desired including spray times and off times.
11. When finished, press the other batch size and repeat step # 10.
12. When finished setting both batch sizes, press and release **DONE**. The display should read **2 BATCHES DONE?**
13. If both batch sizes are not correct, press and release **NO** to return to the **BREW TIME** setup screen and repeat steps 10, 11 and 12.
14. If both batch sizes are correct, press **YES**. The display will show the pulse settings to accommodate the brew time entered. Press and release each batch size to display the settings for that batch. After a delay, the display should now read **DRIP TIME:**. To exit to the **MAIN SCREEN**, press and release the **ON/OFF** button.

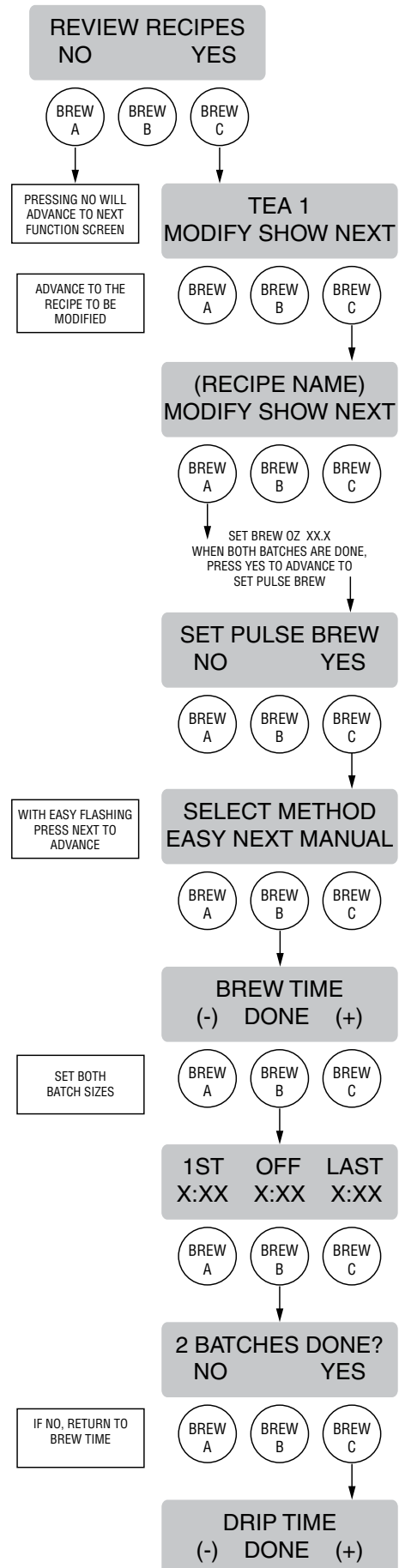

P2867

PROGRAMMING THE BREWER (cont.)

PROGRAMMING FUNCTIONS - LEVEL 2 (cont.)

Setting Pulse Brew – MANUAL Pulse Brew

NOTE: If the brewer is already on the **SET PULSE BREW** screen, skip steps 1 through 6, and proceed directly to step 7.

1. Press and hold the right hidden button until the display reads **SET LANGUAGE**. Press the right hidden button until the display reads **REVIEW RECIPES**.
 2. Press **YES** to proceed. The display should now read **TEA 1**, along with **MODIFY SHOW NEXT**.
 3. Press and release **NEXT** to advance to the desired coffee recipe to be modified.
 4. Press and release **MODIFY**. The display should read **BREW OZ:**
 5. Press and release **DONE**. The display should read **2 BATCHES DONE?**
 6. Press and release **YES**. The display should now read **SET PULSE BREW**.
 7. Press and release **YES**. The display should now read **SELECT METHOD**.
 8. Press and release **MANUAL**. With **MANUAL** flashing, press and release **NEXT**.
 9. The display should now read **1ST ON TIME** and a batch light will be blinking. Press and release the batch size to be modified.
 10. Using **(-)** and **(+)**, adjust the **1ST ON TIME**.
 11. When finished, press the other batch size and repeat step # 10.
 12. When finished setting both batch sizes, press and release **DONE**.
 13. The display should now read **OFF TIME**. Adjust the **OFF TIME** using **(-)** and **(+)**.
 14. When finished, press the other batch size and repeat step # 13.
- NOTE:** To disable pulse brew, set **1ST ON TIME** to **OFF**. For recipes with a brew volume greater than 86.0 oz. and pulse brew disabled, the following message will appear after the **BREW** button is pressed, **COFFEE FUNNEL?...PRESS BREW "X"**.
15. When finished setting both batch sizes, press and release **DONE**.
 16. The display should now read **LAST ON:**. Adjust the **LAST ON TIME** using **(-)** and **(+)**. If **PREINFUSION** is desired, set the **LAST ON TIME** to **PreI**.
 17. When finished, press the other batch size and repeat step # 16.

18. When finished setting both batch sizes, press and release **DONE**.
19. The display will show the three times just entered. Press and release each batch size to display the settings for that batch. If the **1ST ON TIME** is set to **OFF**, the display will read **PULSE BREW DISABLED**. After a 5 second delay, the display will read **2 BATCHES DONE?**
20. If both the pulse brew settings for both batch sizes are not correct, press and release **NO** to return to the **1ST ON TIME** setup screen and repeat steps 10 through 19.
21. If both batch sizes are correct, press **YES**. The display should now read **DRIP TIME**. To exit to the **MAIN SCREEN**, press and release the **ON/OFF** button.

PROGRAMMING THE BREWER (cont.)

PROGRAMMING FUNCTIONS - LEVEL 2 (cont.)

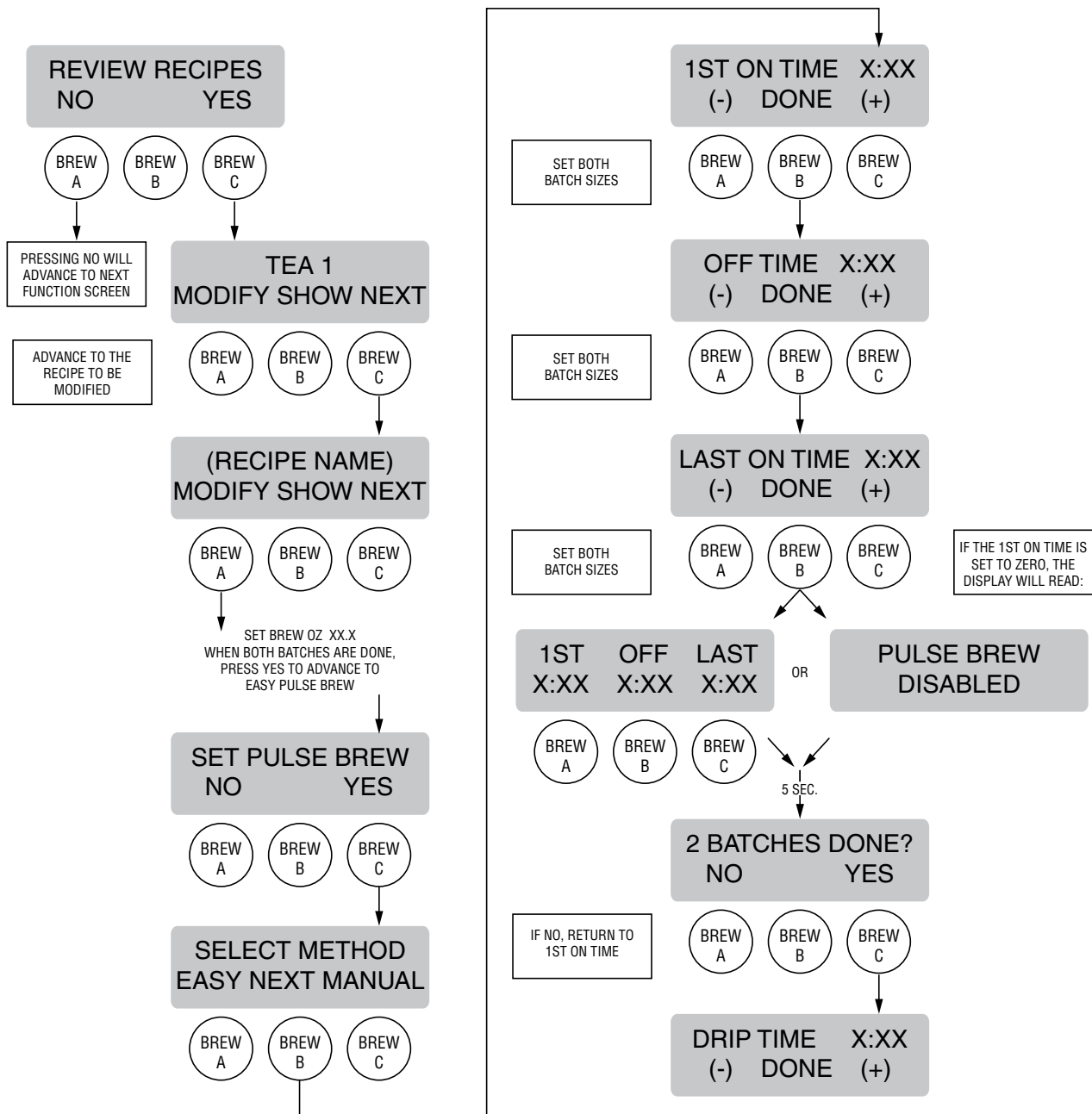

PROGRAMMING THE BREWER (cont.)

PROGRAMMING FUNCTIONS - LEVEL 2 (cont.)

COFFEE RECIPES:

DRIP TIME

This function allows the operator to adjust the **DRIP TIME** (time from end of sprayhead flow to when liquid stops dripping from the funnel). When the brew cycle is complete, the display will show **DRIPPING** and will countdown the time until the funnel empties.

Setting DRIP TIME:

Range: OFF to 5 minutes for all batch sizes.

NOTE: If the brewer is already in the **DRIP TIME** screen, skip steps 1 through 7 and proceed directly to step 8.

1. Press and hold the right hidden button until the display reads **SET LANGUAGE**. Press the right hidden button until the display reads **REVIEW RECIPES**.
2. Press **YES** to proceed. The display should now read **TEA 1**, along with **MODIFY SHOW NEXT**.
3. Press and release **NEXT** to advance to the desired coffee recipe to be modified.
4. Press and release **MODIFY**. The display should read **BREW OZ:**
5. Press and release **DONE**. The display should read **2 BATCHES DONE?**
6. Press and release **YES**. The display will read **SET PULSE BREW**.
7. Press and release **NO**. The display should now read **DRIP TIME** and a batch light should be flashing.
8. Using the **(-)** and **(+)**, set the amount of time from when the brew solenoid shuts off to when drip-out occurs for that batch size.
9. When finished, press the other batch size and repeat step 8.
10. When finished, press **DONE**. The display should read **2 BATCHES DONE?**
11. If both batch sizes are not correct, press and release **NO** to return to the **DRIP TIME** setup screen and repeat steps 8 through 10.
12. If both batch sizes are correct, press **YES**. The

display should show the name of the recipe being programmed (modified) along with **SETUP COMPLETE**. After a 5 second delay, the display will advance to the next recipe name in the brewer's memory. If no other coffee names are present, the display will read **THAT WAS THE LAST RECIPE**. To exit to the **MAIN SCREEN**, press and release the **ON/OFF** button.

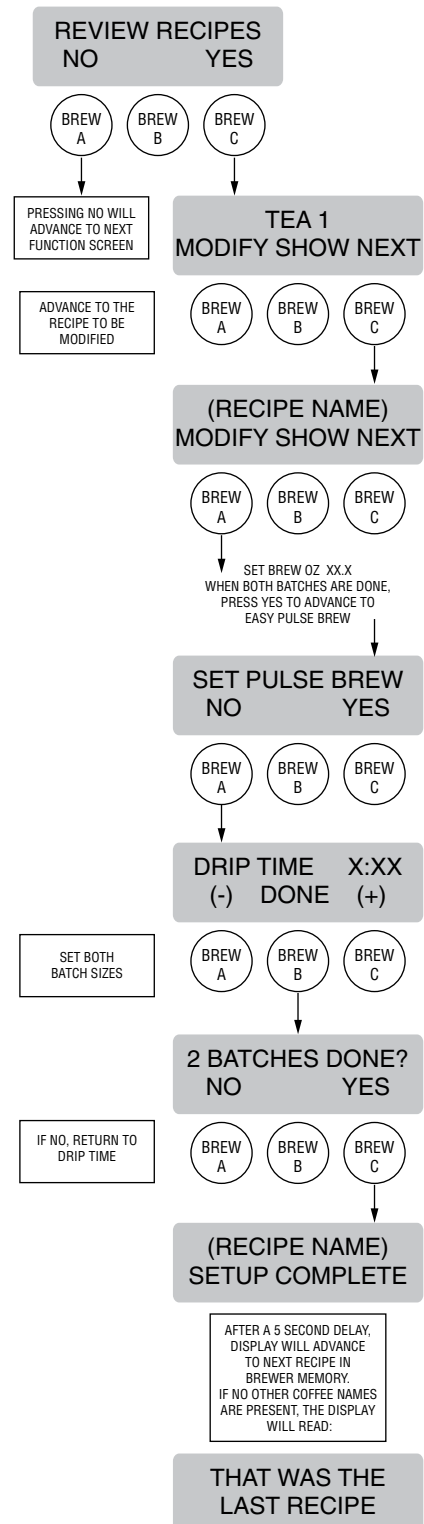

PROGRAMMING THE BREWER (cont.)

PROGRAMMING FUNCTIONS - LEVEL 2 (cont.)

MASTER TEMP

This function allows the operator to adjust the brew water temperature in the tank. This also sets the hot water faucet dispense temperature.

Procedure for setting the Master Temp

Range: 185° to 207° F (85°-97° C)

1. Press and hold the right hidden button until the display reads **SET LANGUAGE**. Press the right hidden button until the display reads **MASTER TEMP**.
2. Using **(-)** and **(+)**, adjust the brew and faucet temperature.
3. When finished, press and release **DONE** to save the new setting and to advance to the next function screen, **READY DEGREE**. Press and release the ON/OFF pad to exit programming and return to the **MAIN SCREEN**.

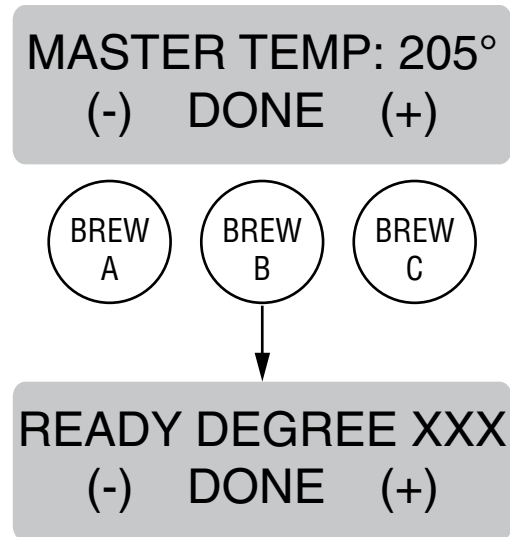

P2870

PROGRAMMING THE BREWER (cont.)

PROGRAMMING FUNCTIONS - LEVEL 2 (cont.)

READY DEGREE

This function allows the operator to set the minimum temperature allowable to start a brew cycle. The range can be from 2° to 20° F within the set temperature. The water must be at the **READY** temperature or higher for the display to indicate **READY TO BREW**. If brew lockout is enabled, the brewing process will not start below this **READY** temperature.

Procedure to set ready temperature

Range: 2° to 20° F (1° - 10° C)

1. Press and hold the right hidden button until the display reads **SET LANGUAGE**. Press the right hidden button until the display reads **READY DEGREE**.
2. Using **(-)** and **(+)**, adjust the ready temperature.
3. When finished, press and release **DONE** to save the new setting and to advance to the next function screen, **ENABLE ADS**. Press and release the ON/OFF pad to exit programming and return to the **MAIN SCREEN**.

READY DEGREE XXX
(-) DONE (+)



ENABLE ADS
NO YES

P2871

PROGRAMMING THE BREWER (cont.)

PROGRAMMING FUNCTIONS - LEVEL 2 (cont.)

ENABLE ADS

This function allows the operator to choose whether or not to display an advertising message. An ad can be saved to the brewer by either writing the ad using the programming commands, or by entering the ad into the brewer using an **AD CARD**. This message will be displayed when the brewer is not in use.

Procedure to Enable/Disable Ads:

1. Press and hold the right hidden button until the display reads **SET LANGUAGE**. Press the right hidden button until the display reads **ENABLE ADS**. The **YES** or **NO** will be flashing to indicate the current selection.
2. Press and release the **NO** button to disable this function (no ads will be displayed on the screen), or:
3. Press and release the **YES** button to enable this function (ads will be displayed on the screen).
4. When finished, press and release **DONE** to save the new setting and advance to the next function screen.
5. If **NO** was selected, the display should now read **ENABLE SANITATION**. To exit programming and return to the **MAIN SCREEN**, press and release the ON/OFF pad.
6. If **YES** was selected, the display should now read **NEW AD?**. This screen allows the operator to select between using an ad card to read in a new ad, writing an ad, or using the ad currently stored in the brewer's memory (if an ad was previously saved).

Procedure to WRITE an Ad:

NOTE: Writing and saving a new ad will erase any previously saved ad in the brewer's memory.

7. From the **NEW AD?** screen, press and release **WRITE**.
8. The display should now read **2 LINES 16 CHARS AVAILABLE**, and then **SCROL THRU ALPHA, NEXT -> NEXT LETTER**, and then **WRITE TOP LINE?**. The ad can be up to 32 characters long, 16 per line. The ad will be written in two steps, first the top line, then the bottom line.
9. To write the top line of a new ad, press and release **YES**. To skip the top line and only write a bottom

line, press and release **NO** and proceed to step 13. To exit programming and return to the **MAIN SCREEN**, press and release the ON/OFF pad.

10. The display will now read **A** with a flashing cursor below it. Press and hold the **SCROLL** button to scroll through the alphabet and available characters. When the desired character is shown on the display, press and release **NEXT** to move to the next character in the top line.
11. Repeat step 10 until the top line is complete.
12. Press and release **DONE**. The display should now read **WRITE BTM LINE?**.
13. To write the bottom line of the new ad, press and release **YES**.
14. To skip the bottom line, press and release **NO**.
 - a. If neither a top nor bottom line was written, the display should now read **ENABL SANITATION**.
 - b. If only a top line was written, the ad will be displayed followed by **SAVE?** Proceed to step 18.
15. The display will now read **A** with a flashing cursor below it. Press and hold the **SCROLL** button to scroll through the alphabet and available characters. When the desired character is shown on the display, press and release **NEXT** to move to the next character in the bottom line.
16. Repeat step 15 until the bottom line is complete.
17. Press and release **DONE**. The display will now show the written ad, and then **SAVE?**
18. To cancel saving the ad, press and release **NO**. The display should now read **ADVERTISEMENT NOT SAVED!** and then will return to the **NEW AD** screen. To exit programming and return to the **MAIN SCREEN**, press and release the ON/OFF pad.
19. To correct or edit the ad, press and release **EDIT**. The display should now read **WRITE TOP LINE?** Repeat steps 10 through 17.
20. To save the ad as it is shown, press and release **YES**. The display should now read **ADVERTISEMENT SETUP COMPLETE**, and then **ENABL SANITATION**. To exit programming and return to the **MAIN SCREEN**, press and release the ON/OFF pad.

PROGRAMMING THE BREWER (cont.)

PROGRAMMING FUNCTIONS - LEVEL 2 (cont.)

ENABL SANITATION

This function allows the operator to enable the sanitation function and set the time before a cleaning alert will be displayed.

Procedure for enabling sanitation:

Range: 0.0 to 72.0 hrs.

1. Press and hold the right hidden button until the display reads **SET LANGUAGE**. Press the right hidden button until the display reads **ENABL SANITATION**. The **YES** or **NO** will be flashing to indicate the current selection.
2. Press and release the **NO** button to disable this function (no sanitation alert will be displayed on the screen), or:
3. Press and release the **YES** button to enable this function (a sanitation alert will displayed on the screen).
4. When finished, press and release **DONE** to save the new setting and advance to the next function screen.
5. If **NO** was selected, the display should now read **ENABLE ENERGYSAVR**. To exit programming and return to the **MAIN SCREEN**, press and release the ON/OFF pad.
6. If **YES** was selected, the display should now read **X.X HRS -> CLEAN**. This screen allows the operator to set the amount of time from when a brew is completed until a sanitize alert will be displayed. Use **(-)** and **(+)** to adjust the set time. When finished, press and release **DONE**.

NOTE: The timer will not begin until after a brew cycle has been completed.

7. The display should now read **X.X HRS UNTIL NEXT CLEAN**, and then advance to the next programming function, **ENABLE ENERGYSAVR**.
8. Once the set time has expired, the display will read **PLEASE SANITIZE**, and then **PRESS FULL FOR 3 SEC TO CANCEL**.
9. Clean and sanitize the machine.
10. When finished, press and hold the FULL batch button to reset the Sanitation timer. The display should now read **SANITATION COMPLETE** and then will return to the **MAIN SCREEN**.

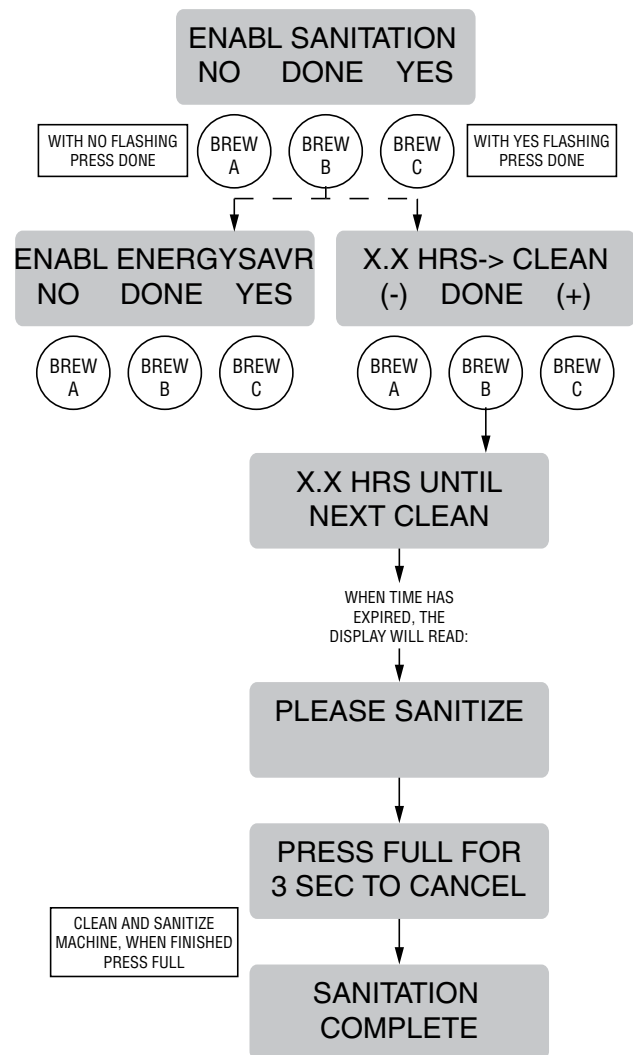

P2873

PROGRAMMING THE BREWER (cont.)

PROGRAMMING FUNCTIONS - LEVEL 2 (cont.)

ENABLE ENERGYSAVR

This function allows the operator to enable the mode function and set the idle time. Once the set idle time has expired, the operator can choose to have the heaters either turn off, or reduce the tank holding temp to 140° F (60° C).

Procedure to enable energy savings mode:

Range: 0.5 to 24.0 hrs. If enabled, default setting is 140°F tank temperature after 4.0 hrs. idle time.

1. Press and hold the right hidden button until the display reads **SET LANGUAGE**. Press the right hidden button until the display reads **ENABLE ENERGYSAVR**. The **YES** or **NO** will be flashing to indicate the current selection.
2. Press and release the **NO** button to disable this function, or:
3. Press and release the **YES** button to enable this function (the heaters will either turn off or the tank will hold at 140° F).
4. When finished, press and release **DONE** to save the new setting and advance to the next function screen.
5. If **NO** was selected, the display should now read **EnableFreshTimer**. To exit programming and return to the **MAIN SCREEN**, press and release the ON/OFF pad.
6. If **YES** was selected, the display should now read **X.X HRS -> IDLE**. This screen allows the operator to set the amount of time the brewer is not in use before nap mode engages. Using **(-)** and **(+)**, adjust the idle time. When finished, press and release **DONE**.
7. The display should now read **AFTER IDLE TIME?** Once the set idle time has expired, the heaters can either be shut off or held at a lower temperature of 140° F.
8. To have the machine shut off after the set idle time, press and release **OFF** and then **DONE** to save the settings. The display should read **MACHINE OFF AFTER X.X HRS**, and then **EnableFreshTimer**.
9. To have the heaters hold at the lower 140° F temperature, press and release **140° F** and then **DONE** to save the settings. The display should read **MACHINE AT 140° F AFTER X.X HRS**, and then **EnableFreshTimer**.

10. Once the idle time has expired, the display will read either **ENERGY SAVER...NO TEMPERATURE** or **ENERGY SAVER...REDUCED TEMPERATURE**, depending on the settings. This screen will alternate with **PRESS ANY SWITCH TO RE-HEAT**.

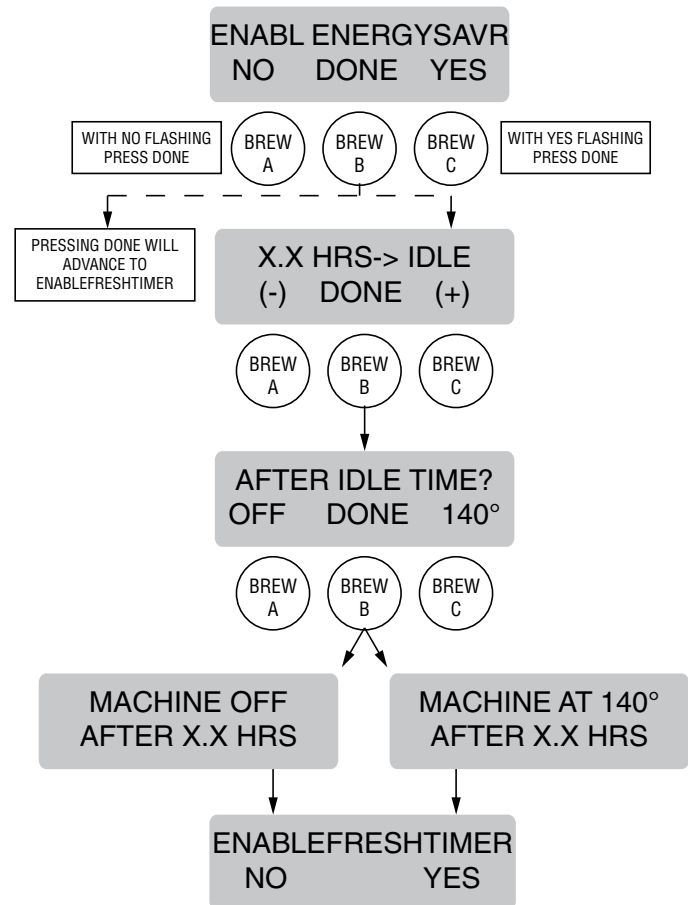

P2874

PROGRAMMING THE BREWER (cont.)

PROGRAMMING FUNCTIONS - LEVEL 2 (cont.)

ENABLE FRESH TIMER

This function allows the operator to enable the Freshness Alert and set the expiration time. The expiration time is the amount of time the product is allowed to sit in the server/dispenser before a fresh batch is brewed.

Procedure for enabling/setting the Freshness Timer:
Range: Iced Tea 0.5 to 10.0 hrs. Hot Tea 0.5 to 8.0 hrs. Iced Coffee 0.5 to 8.0 hrs. Coffee 0.5 to 4.0 hrs.
If enabled, default setting is 8.0 hrs. for Iced Tea, 2.0 hrs for Hot Tea, 4.0 hrs for Iced Coffee, and 2.0 hrs. for Coffee.

1. Press and hold the right hidden button until the display reads **SET LANGUAGE**. Press the right hidden button until the display reads **ENABLEFRESH-TIMER**.
2. Press and release the **NO** button to disable this function, or:
3. Press and release the **YES** button to enable this function (the unit will display a message once the set time has expired).
4. When finished, press and release **DONE** to save the new setting and advance to the next function screen.
5. If **NO** was selected, the display should now read **REFILL**. To exit programming and return to the **MAIN SCREEN**, press and release the ON/OFF pad.
6. If **YES** was selected, the display should now read **TEA**. This screen allows the operator to set the amount of time from the end of brewing a batch of tea until a Freshness Alert message will be displayed. Using **(-)** and **(+)**, adjust the freshness time for tea. When finished, press and release **DONE**.
7. The display should now read **HOT TEA**. Using **(-)** and **(+)**, adjust the freshness time for hot tea. When finished, press and release **DONE**.
8. The display should now read **ICED COFFEE**. Using **(-)** and **(+)**, adjust the freshness time for iced coffee. When finished, press and release **DONE**.
9. The display should now read **COFFEE**. Using **(-)** and **(+)**, adjust the freshness time for coffee. When finished, press and release **DONE**.
10. This display should now read **REFILL**. To exit programming and return to the **MAIN SCREEN**, press and release the ON/OFF pad.

11. Once the set time has expired, the display will read **FRESHNESS ALERT BREW X**, and then **FRESHNESS ALERT BREW FRESH BATCH** alternating with the **MAIN SCREEN**.
12. Empty the server/dispenser the previous batch was brewed into and replace under the funnel.
13. Brew a new batch
14. The freshness timer will reset. The display should now return to the **MAIN SCREEN**.

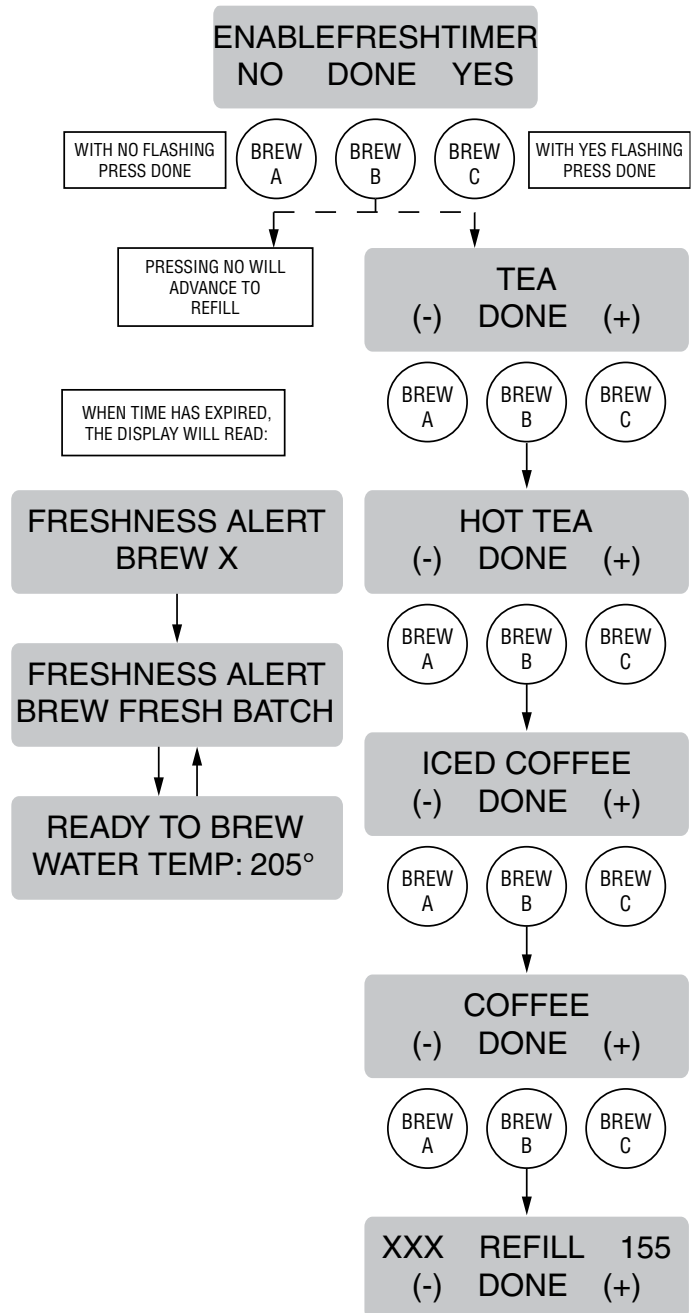

PROGRAMMING THE BREWER (cont.)

PROGRAMMING FUNCTIONS - LEVEL 2 (cont.)

REFILL

Range: 0 to 155

This function allows the operator to adjust the sensitivity of the refill circuit. This is mainly a troubleshooting feature. Water in different geographical locations can have different conductivities. By adjusting the sensitivity of the refill circuit, this will allow the brewer to operate under various water conditions.

Procedure to set the sensitivity threshold of the refill circuit:

NOTE: Make sure the water in the tank is touching the refill probe.

1. Press and hold the right hidden button until the display reads **SET LANGUAGE**. Press the right hidden button until the display reads **REFILL** and shows a number on both sides of the word.
2. To adjust the threshold setting, press **(-)** to decrease or **(+)** to increase the setting.

NOTE: Always make sure that the number on the right is larger than the number on the left when water is in contact with the refill probe in the tank.

3. When finished, press and release **DONE**. This saves the new setting and advances to the next function screen **SPRAY OZ/M**. To exit programming and return to the **MAIN SCREEN**, press and release the ON/OFF pad.

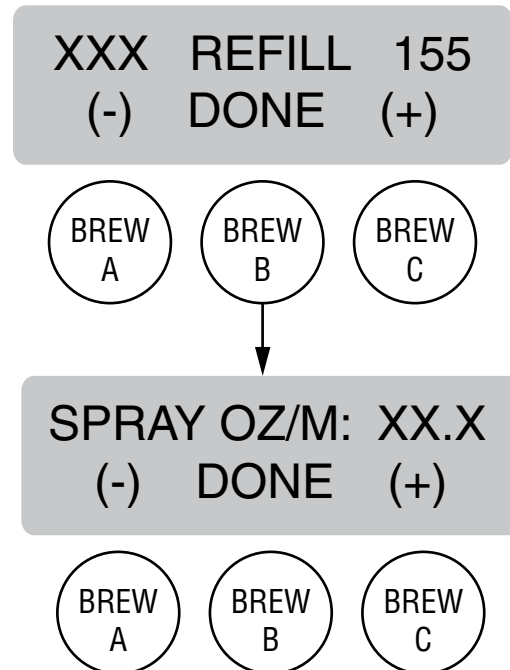

P2876

PROGRAMMING THE BREWER (cont.)

PROGRAMMING FUNCTIONS - LEVEL 2 (cont.)

SPRAY OZ/M

This function allows the operator to view or to enter the actual flow rate coming out of the sprayhead. This is **NOT** used to change the actual flow rate, but to tell the internal controller how fast the water is flowing.

Procedure to adjust the sprayhead flow rate setting:

1. Press and hold the right hidden button until the display reads **SET LANGUAGE**. Press the right hidden button until the display reads **SPRAY OZ/M**. The number represents what the brewer thinks is the flow rate out of the sprayhead.
2. If the actual flow rate of the sprayhead is known but is different than the number on the display, use the **(-)** and **(+)** to enter the correct flow rate.
3. When finished, press and release **DONE**. This saves the new setting and advances to the next function screen, **DILUTE OZ/M**. To exit programming and return to the **MAIN SCREEN**, press and release the **ON/OFF** pad.

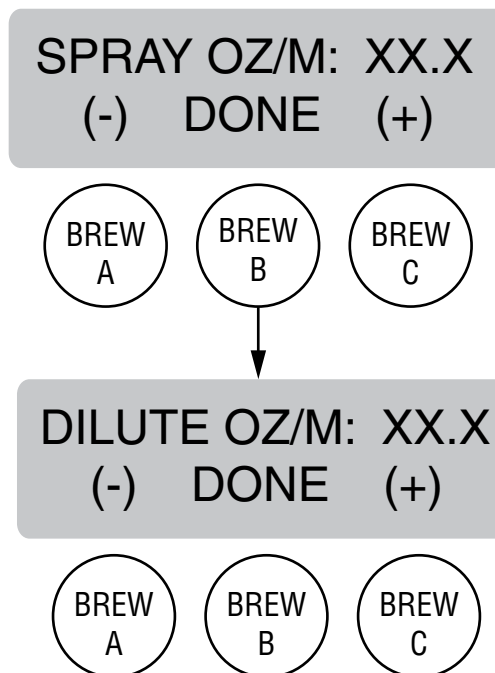

P2877

PROGRAMMING THE BREWER (cont.)

PROGRAMMING FUNCTIONS - LEVEL 2 (cont.)

DILUTE OZ/M

This function allows the operator to view or to enter the actual flow rate coming out of the dilution nozzle. This is **NOT** used to change the actual flow rate, but to tell the internal controller how fast the water is flowing.

Procedure to adjust the dilution flow rate setting:

1. Press and hold the right hidden button until the display reads **SET LANGUAGE**. Press the right hidden button until the display reads **DILUTE OZ/M**. The number represents what the brewer thinks is the flow rate out of the dilution nozzle.
2. If the actual flow rate of the nozzle is known but is different than the number on the display, use the **(-)** and **(+)** to enter the correct flow rate.
3. When finished, press and release **DONE**. This saves the new setting and advances to the next function screen, **CALIBRATE FLOW**. To exit programming and return to the **MAIN SCREEN**, press and release the ON/OFF pad.

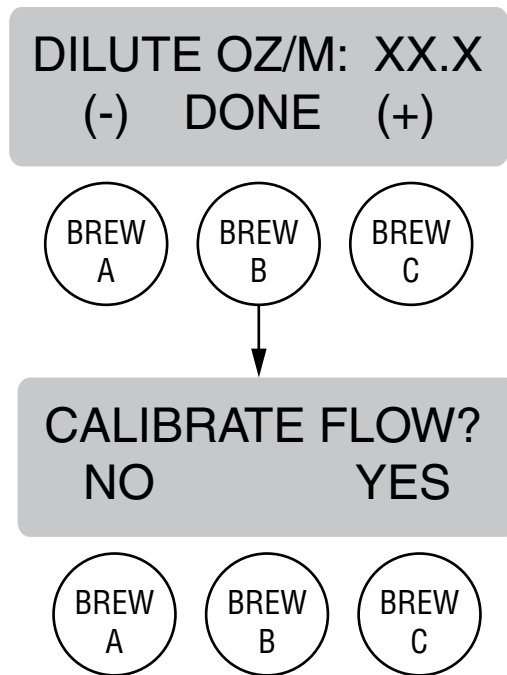

P2878

PROGRAMMING THE BREWER (cont.)

PROGRAMMING FUNCTIONS - LEVEL 2 (cont.)

CALIBRATE FLOW

This function allows the operator to enter the actual flow rate of the sprayhead and the dilution by dispensing both separately for one minute. The volumes are then entered into the brewer.

Procedure to calibrate the sprayhead flow rate:

1. Place a container, accurately graduated and with a minimum capacity of 60 ounces (1.77 liters), beneath the funnel.
2. Press and hold the right hidden button until the display reads **SET LANGUAGE**. Press the right hidden button until the display reads **CALIBRATE FLOW**.
3. Press and release **YES** to advance to the **SPRAY HEAD CAL** function screen. (Pressing **NO** in the **CALIBRATE FLOW** screen will advance to the next function screen, **BREW COUNTERS**).
4. Press and release the **YES** pad. The display should read **CONTAINER READY?** If the container is under the funnel, press **YES**.
5. The display should read **CALIBRATE SPRAY**. Press and release **START** to begin the sprayhead flow for calibration. The display should read **CALIBRATE SPRAY... 60 SEC TO FINISH**. The 60-second timer on the display will count down to zero. When the counter reaches zero, the display will change to **SPRAY HD OZ/M**, along with a number.
6. Measure the amount of water in the container and use the **(-)** and **(+)** pads to adjust the amount of the display to match the amount in the container. Then press **DONE**.
7. The display should now read **NEW SPRAY FLOW**, along with the correct flow rate of the sprayhead. After about 5 seconds, the display will return to the **CALIBRATE FLOW** screen.
8. To exit the **CALIBRATE FLOW** function and advance to the next function screen, press and release **NO**. To exit programming, press and release the ON/OFF button to return to the **MAIN SCREEN**.



PROGRAMMING THE BREWER (cont.)

PROGRAMMING FUNCTIONS - LEVEL 2 (cont.)

CALIBRATE FLOW (Continued)

Procedure to calibrate the dilution flow rate:

1. Place a container, accurately graduated and with a minimum capacity of 130 ounces, beneath the funnel.

NOTE: If the display is already on the **DILUTION CAL** screen, skip steps 2 & 3 and proceed directly to step 4.

2. Press and hold the right hidden button until the display reads **SET LANGUAGE**. Press the right hidden button until the display reads **CALIBRATE FLOW**.
3. Press and release **YES** to advance to the **SPRAY HEAD CAL** function screen. Press and release **NO** to advance to **DILUTION CAL**.
4. Press and release the **YES** pad. The display should read **CONTAINER READY?** If the container is under the funnel, press **YES**.
5. The display should read **CALIBRATE DILUTE**. Press and release **START** to begin the dilution flow for calibration. The display should read **CALIBRATE DILUTE...60 SEC TO FINISH**. The 60-second timer on the display will count down to zero. When the counter reaches zero, the display will change to **DILUTE OZ/M**, along with a number.
6. Measure the amount of water in the container and using the **(-)** and **(+)** pads, adjust the amount of the display to match the amount in the container. Then press **DONE**.
7. The display should now read **NEW DILUTE FLOW**, along with the correct flow rate of the sprayhead. After about 5 seconds, the display will return to the **CALIBRATE FLOW** screen, **BREW COUNTERS**. To exit programming, press and release the ON/OFF button to return to the **MAIN SCREEN**.

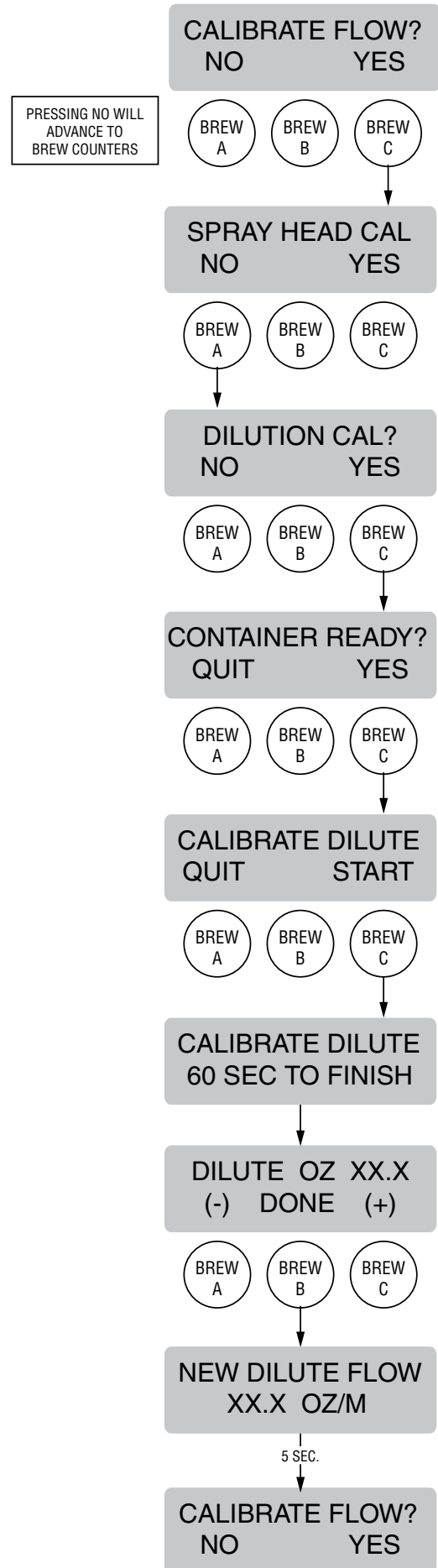

PROGRAMMING THE BREWER (cont.)

PROGRAMMING FUNCTIONS - LEVEL 2 (cont.)

BREW COUNTERS

This function allows the operator to track the total number of brew cycles completed, as well as the number of batches brewed using each of the brew buttons. There are three resettable counters, and one life counter that is not resettable.

Procedure to view/reset the brew counters:

1. Press and hold the right hidden button until the display reads **SET LANGUAGE**. Press the right hidden button until the display reads **BREW COUNTERS**.
2. Pressing **NO** will advance to the next programming function, **RECIPE TEMP**. Press **YES** to view the first brew counter (**TOTAL LIFE BREWS**). This number represents the total number of brew cycles this brewer has completed. This counter is non-resettable. Press **NEXT** to advance to the next brew counter, **BREW A**.
3. This counter represents the number of brews for Brew A. To reset the counter to zero, press and release **RESET**. Press and release **NEXT** to advance to the next counter.
4. Repeat step 3 for the remaining two counters, **BREW B** and **BREW C**.
5. When finished, press **NEXT** to advance to the next programming function, **SET RECIPE TEMPS**. To exit programming, press and release the ON/OFF button to return to the **MAIN SCREEN**.

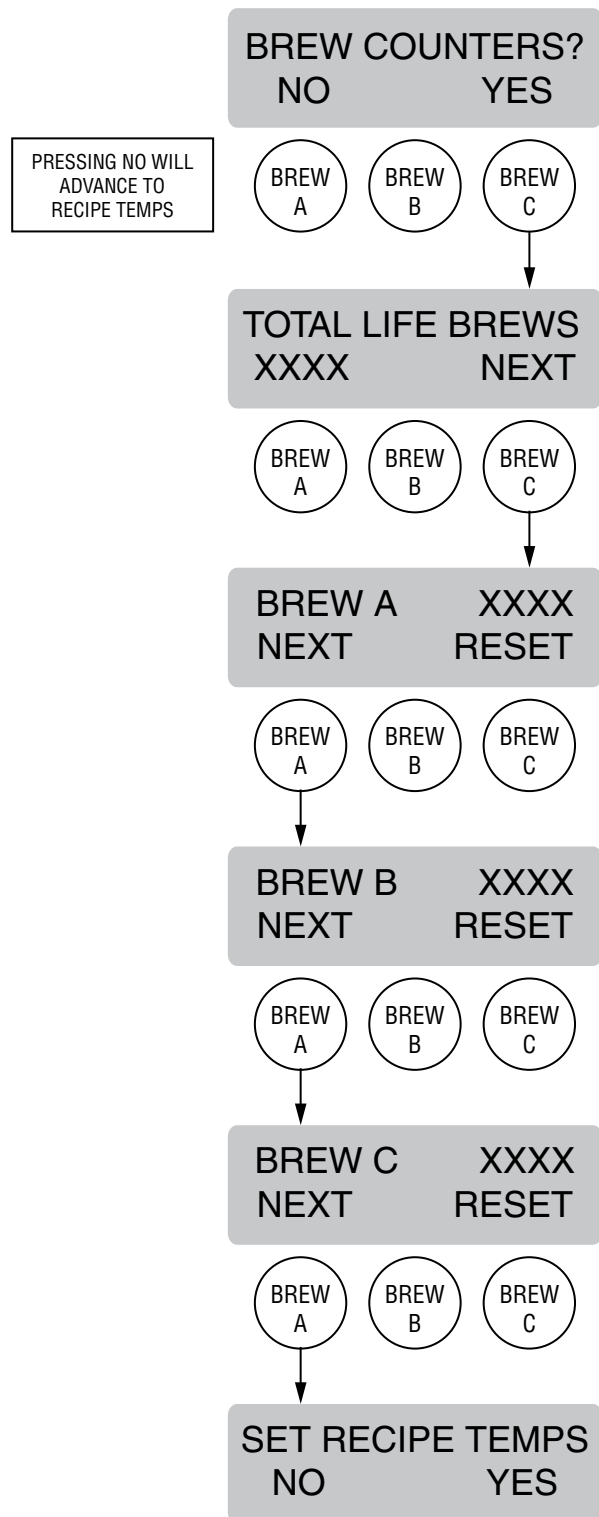

P2881

PROGRAMMING THE BREWER (cont.)

PROGRAMMING FUNCTIONS - LEVEL 2 (cont.)

SET RECIPE TEMPS

This function allows the operator to set separate temperatures for each selected recipe.

NOTE: Setting recipe temps will override the **MASTER TEMP**. The tank will hold at the lowest temperature between the three selected recipes stored in the brew buttons. For instance, let's say Brew A's recipe temperature is set at 205°, Brew B's recipe temperature is set at 205°, and Brew C's recipe temperature is set at 200°. The tank will hold at 200°. If Brew A or Brew B is pressed, the tank will heat to the 205° temperature. The brew button must be pressed again in order for a brew to start. After the completion of that brew, the tank will return to the 200° holding temperature. It may take awhile for the tank to return to the lower temperature.

1. Press and hold the right hidden button until the display reads **SET LANGUAGE**. Press the right hidden button until the display reads **SET RECIPE TEMPS**.
2. To set different temperatures for different recipes, press and release **YES**. Pressing **NO** will advance to the next programming function, **SERVICE TOOLS**.
3. The display should read **WILL OVERRIDE THE MASTER TEMP**, and then **OVERRIDE?** To retain the **MASTER TEMP** setting, press and release **NO**. To set separate recipe temperatures, press and release **YES**.
4. The display should read **TEA 1**. Using **(-)** and **(+)**, adjust the temperature for **TEA 1**. When finished, press and release **DONE**.
5. The screen should now read **TEA 2**. Use **(-)** and **(+)** to adjust the temperature for **TEA 2**. When finished, press and release **DONE**.
6. Repeat for all standard and stored recipes.
7. After the last temperature has been entered, press **DONE**. The screen should now read **TANK WILL HOLD AT LOWEST TEMP**, and then advance to the **ENTER ASSET #** screen. To exit programming, press and release the ON/OFF button to return to the **MAIN SCREEN**.

NOTE: To return to using the **MASTER TEMP** setting after **RECIPE TEMPS** have been used, press and hold

the right hidden switch until the display reads **SET LANGUAGE**. Press and release the right hidden switch until the display reads **SET RECIPE TEMPS**. Press and release **YES**. The display will read **WILL OVERRIDE THE MASTER TEMP**, and then **OVERRIDE?** To return to using the **MASTER TEMP**, press and release **NO**.

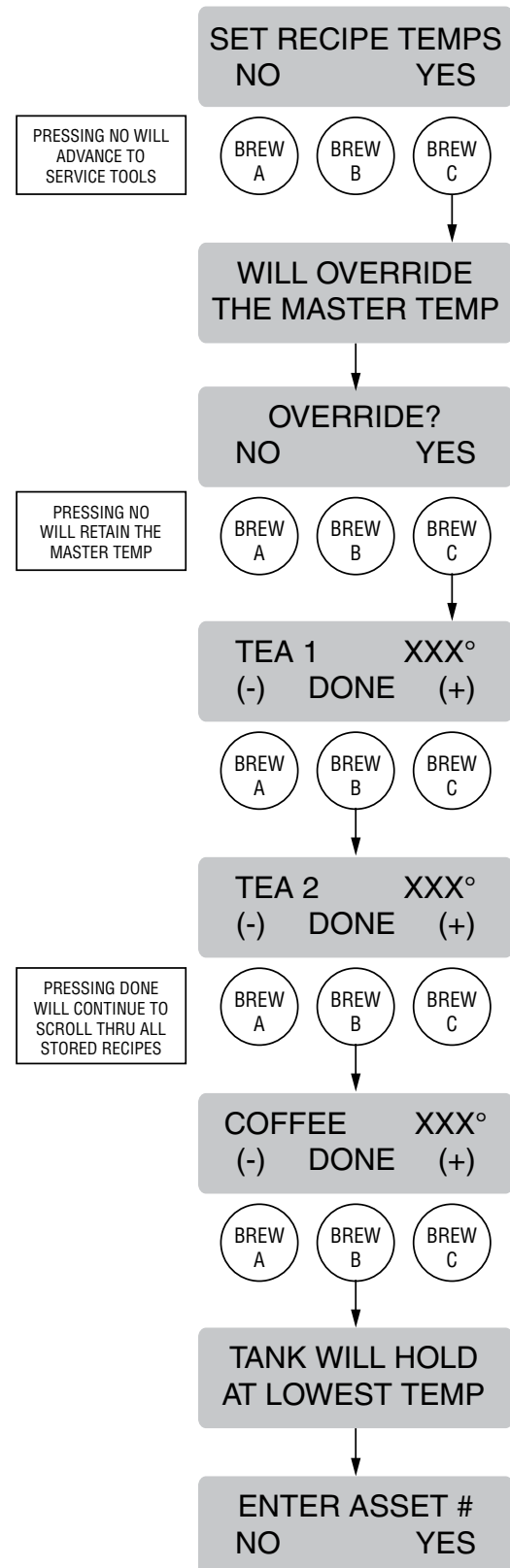

PROGRAMMING THE BREWER (cont.)

PROGRAMMING FUNCTIONS - LEVEL 2 (cont.)

ASSET NUMBER

This function allows the operator to enter in the machine's asset number. This can be useful for tracking the usage or service of an individual machine within a group.

Procedure to enter the asset number:

1. Press and hold the right hidden button until the display reads **SET LANGUAGE**. Press the right hidden button until the display reads:
ENTER ASSET #?
2. Press and release **YES**. The display will now read **ANXXXXXX**.
3. Using **(-)** and **(+)**, set the asset number of the machine.
4. When finished, press and release **DONE**. The display will now read **SERVICE #**.

NOTE: See page 9 for steps on how to view the Asset Number.

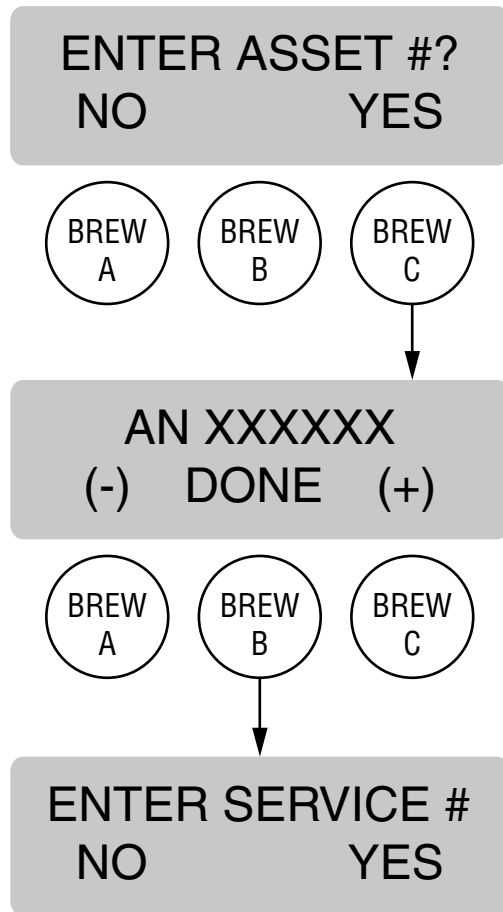

P2951

PROGRAMMING THE BREWER (cont.)

PROGRAMMING FUNCTIONS - LEVEL 2 (cont.)

SERVICE NUMBER

This function allows the operator to enter in the telephone number to call if service is needed. The service number will be displayed anytime there is a fault message displayed. (See Troubleshooting on page 63)

Procedure to enter the service number:

1. Press and hold the right hidden button until the display reads **SET LANGUAGE**. Press the right hidden button until the display reads:
ENTER SERVICE #?
2. Press and release **YES**. The display will now read **SCROL THRU #'S NEXT ->NEXT NUMBER**, followed by **000-000-0000**. Up to 16 characters are available.
3. Press the **SCROL** button to scroll through the numbers. When the desired number is shown, press and release **NEXT** to move to the next digit in the phone number.
4. Repeat Step 3 until the entire number is entered.
5. Press and release **DONE**. The display will now read **SERVICE TOOLS?**

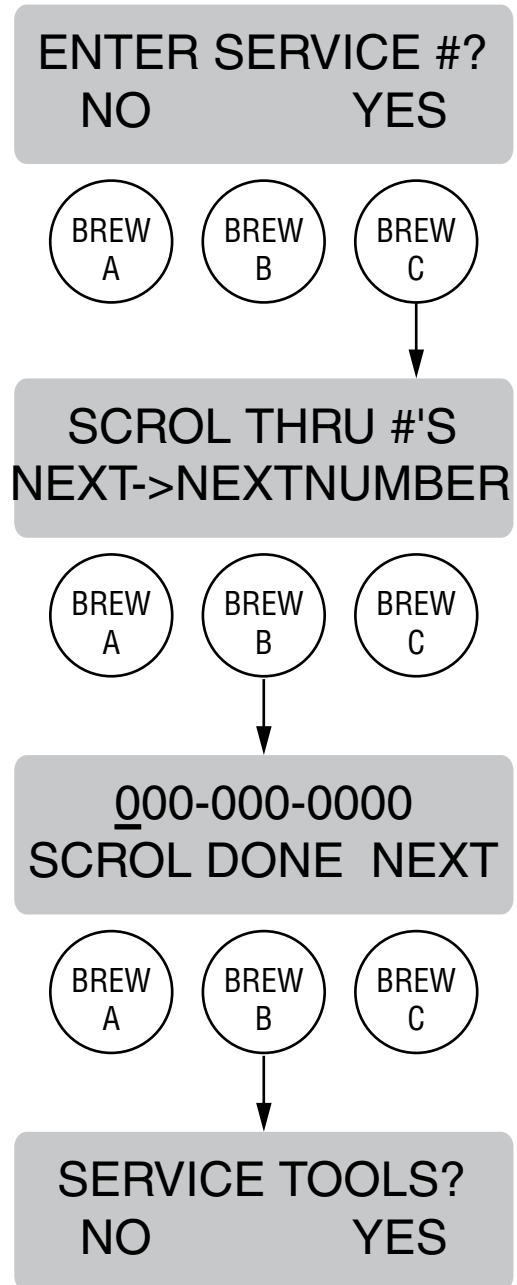

P3049

PROGRAMMING THE BREWER (cont.)

PROGRAMMING FUNCTIONS - LEVEL 2 (cont.)

SERVICE TOOLS

This function allows the testing of individual components and the ability to check switches for proper function. This function also tests the funnel sensor coil's frequency (diagnostic tool for troubleshooting purposes only).

Procedure to test components and outputs:

The following components can be individually tested:

Brew Valve

Dilution Valve

Refill Valve

Tank Heater Relay

Tank Heater Triac

1. Place a funnel into the rails of the brewer.
2. Place a server beneath the funnel.
3. Press and hold the right hidden button until the display reads **SET LANGUAGE**. Press the right hidden button until the display reads **SERVICE TOOLS**.
4. Press and release **YES**. The display should now read **TEST OUTPUTS?** Press and release **YES** to test individual components and outputs. Pressing **NO** will advance to the next programming function, **TEST SWITCHES**.
5. The display should now read **BREW VALVE**. To test the brew valve, press **ON**. If the brew valve is functional, water should run from the funnel.
6. Press **OFF** to end the flow of water.
7. Press **NEXT** to advance to the next component to be tested.

NOTE: To bypass testing any component, press **NEXT** to advance to the next component without testing the previous one.

8. The display should now read **DILUTION**. To test the dilution valve, press **ON**. If the dilution valve is functional, water should run from the nozzle.
 9. Press **OFF** to end the flow of water.
 10. Press **NEXT** to advance to the next component to be tested, **REFILL VALVE**.
 11. To test the **REFILL VALVE**, press **ON**. If the refill valve is functional, the sound of the valve operating will be heard.
 12. Press **OFF** to end testing of the refill valve.
 13. Press **NEXT** to advance to the next component to be tested, **TANK HEATR RELAY**.
 14. To test the tank heater relay, connect a voltmeter across each of the tank heaters to check for voltage.
 15. Press **ON**. The correct voltage should be present at the heater terminals.
 16. Press **OFF** to end testing of the tank heater relay.
- NOTE:** The tank heater will automatically turn off if left on too long.
17. Press **NEXT** to advance to the next component to be tested, **TANK HEATR TRIAC**.
 18. To test the tank heater triac, connect a voltmeter across each of the tank heaters to check for voltage.
 19. Press **ON**. The correct voltage should be present at the heater terminals.
 20. Press **OFF** to end testing of the tank heater triac.
 21. Press **NEXT** to **TEST OUTPUTS?**. To exit programming, press and release the ON/OFF button to return to the **MAIN SCREEN**.

PROGRAMMING THE BREWER (cont.)

PROGRAMMING FUNCTIONS - LEVEL 2 (cont.)

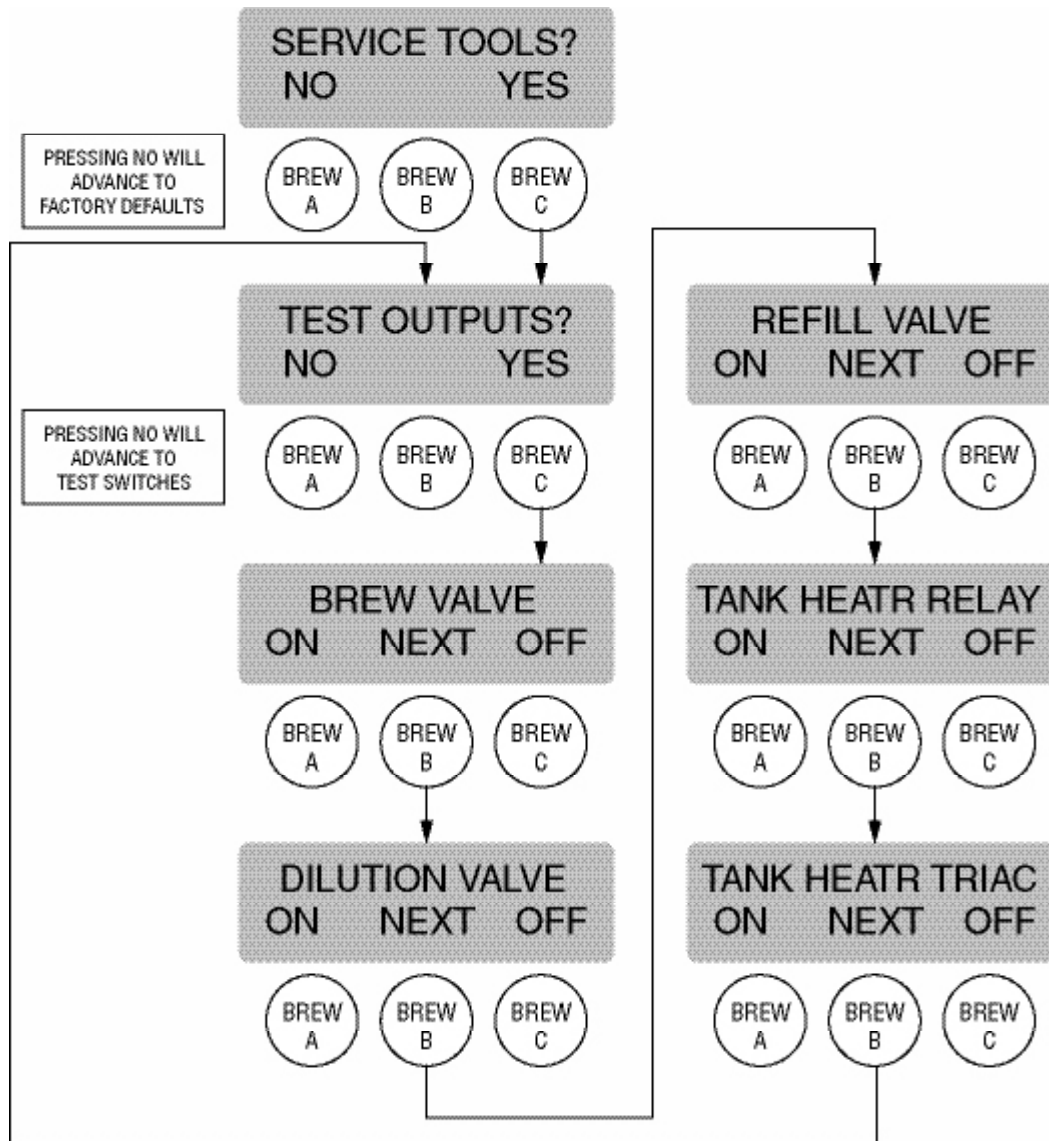

P2883

PROGRAMMING THE BREWER (cont.)

PROGRAMMING FUNCTIONS - LEVEL 2 (cont.)

Procedure to test coil frequency:

1. Press and hold the right hidden button until the display reads **SET LANGUAGE**. Press the right hidden button until the display reads **SERVICE TOOLS**.
2. Press and release **YES**. The display should now read **TEST OUTPUTS?** Press and release **NO** to advance to **TEST SWITCHES**.
3. Press and release **NO** to advance to **TEST FREQUENCY**.
4. The display should now show the frequency of the sensor coil circuit. This is for diagnostic service use when troubleshooting this circuit.
5. After the coil has been tested, press and release the ON/OFF button to return to the **MAIN SCREEN**.

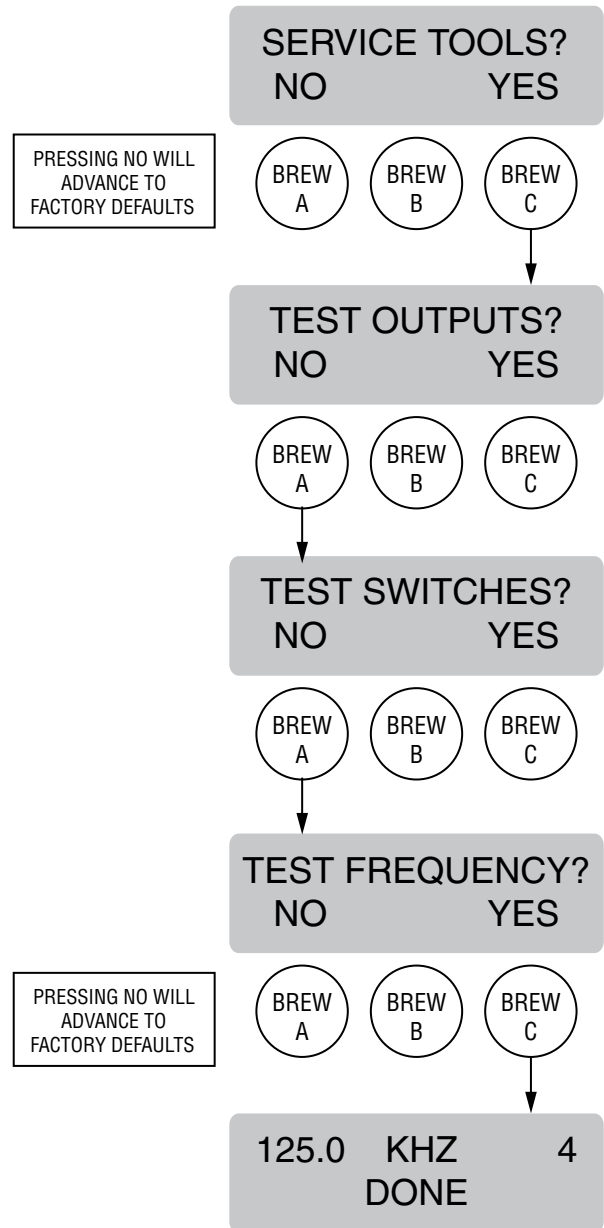

P2885

PROGRAMMING THE BREWER (cont.)

PROGRAMMING FUNCTIONS - LEVEL 2 (cont.)

FACTORY DEFAULTS

This function allows the operator to erase **ALL** of the previously entered recipes and ad messages. Factory-set default values will replace **ALL** previous settings.

Procedure to set factory defaults:

1. Press and hold the right hidden button until the display reads **SET LANGUAGE**. Press the right hidden button until the display reads **FACTORY DEFAULTS**.
2. Pressing **NO** will return to the **MAIN SCREEN**. Press **YES** to restore defaults. The display will read **WILL REPLACE ALL BREW SETTINGS** followed with **ARE YOU SURE?**
3. Pressing **NO** in this confirmation screen will revert to the **MAIN SCREEN** without resetting the brewing setups to the defaults. Press **YES** to load the defaults. After factory defaults have been restored, the display will return to the **MAIN SCREEN**. The factory default valves will have replaced **ALL** previously entered values. It will NOT reset the life brew counter. If factory defaults are restored, it will be necessary to recalibrate the flow rates. Refer to pages 50-51.

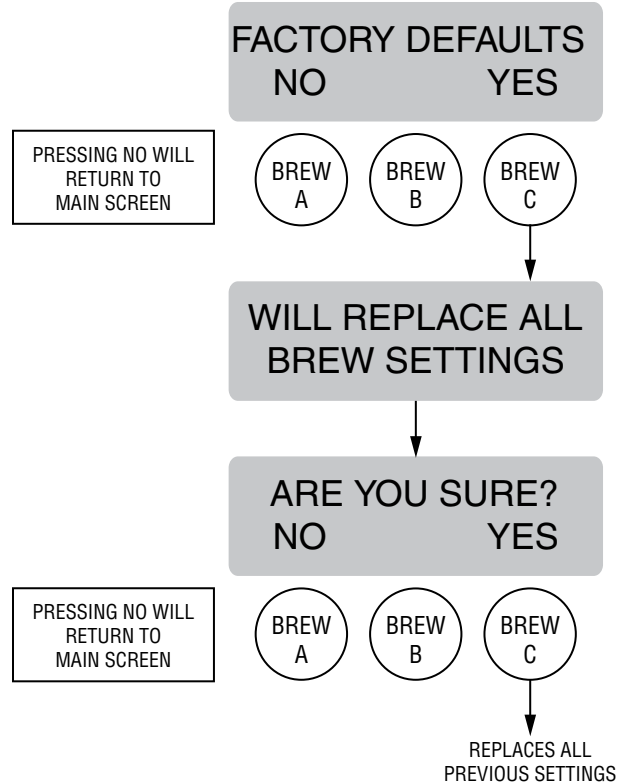

P2886

PROGRAMMING THE BREWER (cont.)

PROGRAMMING FUNCTIONS - LEVEL 2 (cont.)

FACTORY DEFAULT VALUES

Brew Lockout - Disabled

Language - English

Units - English

SWITCH RECIPE

Brew A – TEA 1

Brew B – HOT TEA

Brew C – NO-NAME COFFEE

TEA 1 RECIPE:

BREW VOLUMES

Half Batch – 38 OZ

Full Batch – 76 OZ

DILUTION VOLUMES

Half Batch – 160 OZ

Full Batch – 320 OZ

DILUTION DELAY

Half Batch – 0:00

Full Batch – 0:00

PULSE BREW TIMES

Half Batch – Manual :30/:15/:15

Full Batch – Manual :30/:15/:15

DRIP OUT TIMES

Half Batch – 0:55

Full Batch – 1:20

TEA 2 RECIPE:

BREW VOLUMES

Half Batch – 38 OZ

Full Batch – 76 OZ

DILUTION VOLUMES

Half Batch – 160 OZ

Full Batch – 320 OZ

DILUTION DELAY

Half Batch – 0:00

Full Batch – 0:00

PULSE BREW TIMES

Half Batch – Disabled

Full Batch – Disabled

DRIP OUT TIMES

Half Batch – 1:55

Full Batch – 2:40

TEA 3 RECIPE:

BREW VOLUMES

Half Batch – 45 OZ

Full Batch – 90 OZ

DILUTION VOLUMES

Half Batch – 160 OZ

Full Batch – 320 OZ

DILUTION DELAY

Half Batch – 0:00

Full Batch – 0:00

PULSE BREW TIMES

Half Batch – Manual :30/:15/:15

Full Batch – Manual :30/:15/:15

DRIP OUT TIMES

Half Batch – 1:00

Full Batch – 1:20

PROGRAMMING THE BREWER (cont.)
PROGRAMMING FUNCTIONS - LEVEL 2 (cont.)

FACTORY DEFAULT VALUES (Continued)

HOT TEA RECIPE:

BREW VOLUMES
Half Batch - 64 OZ
Full Batch - 64 OZ

PULSE BREW TIMES

Half Batch - Manual :30/:15/:15
Full Batch - Manual :30/:15/:15

DRIP OUT TIMES

Half Batch - 1:15
Full Batch - 1:15

ICED COFFEE RECIPE:

BREW VOLUMES
Half Batch - 64 OZ
Full Batch - 64 OZ

DILUTION VOLUMES

Half Batch - 0 OZ
Full Batch - 0 OZ

DILUTION DELAY

Half Batch - 0:00
Full Batch - 0:00

PULSE BREW TIMES

Half Batch - Disabled
Full Batch - Manual :45/:10/:15

DRIP OUT TIMES

Half Batch - 1:00
Full Batch - 1:30

NO-NAME COFFEE RECIPE:

BREW VOLUMES
Half Batch - 64 OZ
Full Batch - 64 OZ

PULSE BREW TIMES

Half Batch - Manual :40/:10/:26
Full Batch - Manual :40/:10/:26

DRIP OUT TIMES

Half Batch - 1:00
Full Batch - 1:00

Master Temp - 205°
Ready Temp - 5°

Enable Ads - Disabled

Enable Sanitation - Disabled

Enable Energy Saver Mode - Disabled
IDLE - 4 HRS, THEN 140°

Enable Freshness Timer - Disabled

TEA - 8 HRS
HOT TEA - 2 HRS
ICED COFFEE - 4 HRS
COFFEE - 2 HRS

Spray Oz/m - 26

Dilution Oz/m - 73

Recipe Temps
TEA 1 - 205°
TEA 2 - 205°
TEA 3 - 205°
HOT TEA - 205°
ICED COFFEE - 200°
COFFEE - 200°

TROUBLESHOOTING

A troubleshooting guide is provided to suggest probable causes and remedies for the most likely problems encountered. If the problem remains after exhausting the troubleshooting steps, contact the Bunn-O-Matic Technical Service Department.

- Inspection, testing, and repair of electrical equipment should be performed only by qualified service personnel.
- All electronic components have 120-240 volt ac and low voltage dc potential on their terminals. Shorting of terminals or the application of external voltages may result in board failure.
- Intermittent operation of electronic circuit boards is unlikely. Board failure will normally be permanent. If an intermittent condition is encountered, the cause will likely be a switch contact or a loose connection at a terminal or crimp.
- Solenoid removal requires interrupting the water supply to the valve. Damage may result if solenoids are energized for more than ten minutes without a supply of water.
- The use of two wrenches is recommended whenever plumbing fittings are tightened or loosened. This will help to avoid twists and kinks in the tubing.
- Make certain that all plumbing connections are sealed and electrical connections tight and isolated.
- This brewer is heated at all times. Keep away from combustibles.

- WARNING** –
- Exercise extreme caution when servicing electrical equipment.
 - Unplug the brewer when servicing, except when electrical tests are specified.
 - Follow recommended service procedures.
 - Replace all protective shields or safety notices.

TROUBLESHOOTING (cont.)

| PROBLEM | PROBABLE CAUSE | REMEDY |
|---|--|--|
| Temperature Too Low | 1. Water temperature in the tank does not meet the ready temperature. | A) Wait for the brewer to heat to the proper temperature. B) Disable the BREW LOCKOUT function. See page 17 for procedure. |
| Heating Time Too Long | 1. Tank Heater failure. 2. Control Board/Thermistor failure | Service required Service required |
| Fill Time Too Long | 1. Water shut off to brewer 2. Tank Drain clamp is shut 3. Inlet Solenoid failure 4. Control Board Failure 5. ON/OFF switch is OFF | Check water supply shut-off Check tank drain clamp Service Required Service Required Turn switch ON |
| Temp Sensor Out Of Range, Check For Bad Connections | 1. Temperature Sensor Probe wire(s) broken or not making connection | Check wire and connection of both black and white wires of temperature probe. |
| Temp Sensor Out Of Range, Check Wire For Shorts | 1. Temperature Sensor Probe wire(s) shorted to housing or to each other. | Check to confirm that wire(s) are not pinched between two surfaces or connected to each other. |
| Equipment will not operate | 1. No power or incorrect voltage | Measure the voltage at the terminal block and confirm that it matches the voltage specified on the brewer data plate withing +/- 10%. |

TROUBLESHOOTING (cont.)

| <u>PROBLEM</u> | <u>PROBABLE CAUSE</u> | <u>REMEDY</u> |
|---------------------------|--|---|
| Brew cycle will not start | 1. No water | Check plumbing and shut-off valves |
| | 2. No power or incorrect voltage to the brewer | Check for voltage across the terminals at the terminal block. |
| | 3. ON/OFF switch | Test the ON/OFF switch. Refer to the test switch procedures on page 58. |
| | 4. Brew switch | Test the BREW switch. Refer to the test switch procedures on page 57. |
| | 5. Brew valve | Test the brew valve. Refer to the test outputs procedures on page 56. |
| | 6. Control Board | Substitute a control board known to be in good working order. |

TROUBLESHOOTING (cont.)

| <u>PROBLEM</u> | <u>PROBABLE CAUSE</u> | <u>REMEDY</u> |
|---|--|--|
| Automatic refill will not operate or display shows FILL TIME TOO LONG | 1. No water | Check plumbing and shut-off valves |
| | 2. Tank drain clamp | Check tank drain clamp |
| | 3. Water Strainer | Direction of flow arrow must be pointing towards direction of water flow. |
| | 4. Refill probe or Sensitivity setting | Remove the strainer and check for obstructions. Clear or replace. |
| | 5. Refill valve | Check the sensitivity setting. Refer to the REFILL function on page 47. If the left three digit number is less than the right number, the machine “thinks” it is full and the refill valve should be off. If the left number is larger than the right, then the refill valve will automatically be turned on to fill the tank. The right number is the threshold setting and can be adjusted to compensate for extreme water conditions: very pure, low conductance water requires a higher setting, while high mineral content, high conductance water requires a lower setting. Note that the left number changes from a high value when water is NOT touching the refill probe to a low value when water IS touching the probe. For best operation, the right number should be set to a value midway between these low and high numbers. Before changing the setting, confirm that the refill probe is free of scale buildup and the connection to it is |

TROUBLESHOOTING (cont.)

| <u>PROBLEM</u> | <u>PROBABLE CAUSE</u> | <u>REMEDY</u> |
|---|-----------------------------|---|
| Automatic refill will not operate or display shows FILL TIME TOO LONG (Continued) | 5. Refill valve (Continued) | secure. Test the refill valve. Refer to the test outputs procedures on page 56. Refill valve – Disconnect the brewer from the power source and remove wires from refill valve coil. Check for continuity across the terminals of the solenoid coil. If continuity is not present, replace the refill valve. If continuity is present, the coil may be stuck closed. Shut water off to brewer. Press the ON/OFF switch to turn off the brewer. Open the faucet and drain water down in the tank until flow stops or slows to a trickle. Attach a voltmeter to the terminals of the refill solenoid. Connect the brewer to the power source. Press the ON/OFF switch to turn the brewer on. Within five seconds, voltage should be present at the solenoid terminals. If voltage is not present, refer to the wiring schematic and check the wiring harness. |
| | 6. Control Board | |
| | 7. ON/OFF Switch | Substitute a control board known to be in good working order. |

TROUBLESHOOTING (cont.)

| <u>PROBLEM</u> | <u>PROBABLE CAUSE</u> | <u>REMEDY</u> |
|--|--|--|
| Water flows into tank continuously with power removed from brewer. | 1. Refill valve | Foreign material lodged in valve, holding it in open state. |
| | 2. Refill probe or sensitivity setting | Check the sensitivity setting. Refer to the REFILL function on page 47. If the left three digit number is less than the right number, the machine “thinks” it is full and the refill valve should be off. If the left number is larger than the right, then the refill valve will automatically be turned on to fill the tank. The right number is the threshold setting and can be adjusted to compensate for extreme water conditions: very pure, low conductance water requires a higher setting, while high mineral content, high conductance water requires a lower setting. Note that the left number changes from a high value when water is NOT touching the refill probe to a low value when water IS touching the probe. For best operation, the right number should be set to a value midway between these low and high numbers. Before changing the setting, confirm that the refill probe is free of scale buildup and the connection to it is secure. |
| | 3. Control Board | Substitute a control board known to be in good working order. |

TROUBLESHOOTING (cont.)

| <u>PROBLEM</u> | <u>PROBABLE CAUSE</u> | <u>REMEDY</u> |
|---|-----------------------|---|
| Water will not heat or display shows HEATING TIME TOO LONG. | 1. Limit Thermostat | Remove power from the brewer. Check for continuity through the limit thermostat. CAUTION: Do not eliminate or bypass limit thermostat. Use only replacement part 29329.0001. |
| | 2. Temperature probe | Remove the probe from the grommet and submerge in a water bath of approximately 70°F (21°C). Connect an ohmmeter to the pins in the connector. At 60°F (16°C), the reading should be 15.3k ± 2k OHMS, at 70°F (21°C) the reading should be 11.8k ± 2k OHMS, and at 80°F (27°C) the reading should be 9.3k ± 2k OHMS. If the probe is within these parameters, reconnect to the control board. |
| | 3. Toggle switch | Check that the toggle switch connections are secure and properly wired. Check the toggle switch selects the correct voltage. |

TROUBLESHOOTING (cont.)

| <u>PROBLEM</u> | <u>PROBABLE CAUSE</u> | <u>REMEDY</u> |
|---|-----------------------|---|
| Water will not heat or display shows HEATING TIME TOO LONG. (Continued) | 4. Tank heaters | Remove power from the brewer. Check for continuity between the white terminal of the terminal block (or red terminal on 208/240V models) and the black wire on the relay on the control board (Toggle switch must be in 120/208-240V position on 208V and 240V models). There should be a low OHM reading. If not continuity is present, check for a wiring or switch problem (consult wiring schematic), then replace the tank heater if no wiring or switch problem is found. |
| | 5. Control Board | Remove power from the brewer. Connect a voltmeter across the tank heater. Reapply power to the brewer and refer to testing outputs on page 56. If the voltage measured when the tank heater is turned on is very low or zero, then substitute a control board know to be good working order. |

TROUBLESHOOTING (cont.)

| <u>PROBLEM</u> | <u>PROBABLE CAUSE</u> | <u>REMEDY</u> |
|-------------------------------|-----------------------|--|
| Dilution cycle will not start | 1. Dilution valve | Test the dilution valve. Refer to the test outputs procedures on page 56. |
| | 2. Recipe settings | Check to make sure the current recipe has a dilution volume set. Coffee recipes will not have dilution. |
| | 3. Strainer | Direction of flow arrow must be pointing towards the brewer. Remove the strainer and check for obstructions. Clear or replace. |

TROUBLESHOOTING (cont.)

| <u>PROBLEM</u> | <u>PROBABLE CAUSE</u> | <u>REMEDY</u> |
|--|-----------------------|---|
| Spitting or unusual steaming from sprayhead or air vent. | 1. Lime buildup | Inspect the probe and tank assembly for excessive lime deposits. Delime as required. |
| | 2. Temperature probe | Remove the probe from the grommet and submerge in a water bath of approximately 70°F (21°C). Connect an ohmmeter to the pins in the connector. At 60°F (16°C), the reading should be 15.3k ± 2k OHMS, at 70°F (21°C) the reading should be 11.8k ± 2k OHMS, and at 80°F (27°C) the reading should be 9.3k ± 2k OHMS. If the probe is within these parameters, reconnect to the control board. |
| | 3. Control Board | Remove power from the brewer. Connect a voltmeter across the tank heater. Reapply power to the brewer and refer to testing outputs on page 56. If the voltage measured when the tank heater is turned on is very low or zero, then substitute a control board known to be good working order. |
| Dripout time too long | 1. Funnel tip | The brew funnel should be cleaned thoroughly before each brew cycle to lessen the chance of tea leaf or ground particles clogging the dripout tip. |

TROUBLESHOOTING (cont.)

| <u>PROBLEM</u> | <u>PROBABLE CAUSE</u> | <u>REMEDY</u> |
|---|----------------------------|---|
| Inconsistent beverage level in server/dispenser | 1. Strainer | Direction of flow arrow must be pointing towards the brewer. Remove the strainer and check for obstructions. Clear or replace. |
| | 2. Improper water pressure | Check operating water pressure to the brewer. It must be between 20 and 90 psi (138 and 620 kPa). |
| | 3. Brew valve | Test the brew valve. Refer to test outputs on page 56. Turn the valve on for 30 seconds and collect the water dispensed from the spray-head. Repeat the test several times to confirm a consistent volume of dispensed water. If not consistent, check the valve, tubing and spray-head for lime buildup. |
| | 4. Dilution valve | If dilution is being used on the inconsistent brewing recipe, test the dilution valve. Refer to test outputs on page 56. Turn the valve on for 30 seconds and collect the water collected from the nozzle. Repeat the test several times to confirm a consistent volume of dispensed water. If not consistent, check the valve, tubing and nozzle for lime buildup. |
| | 5. Lime buildup | Inspect for lime buildup that could block the tank, tank fittings, tubing, valves and sprayhead. |
| | 6. Brew volume adjustment | Adjust the brew volume as required to achieve the recommended volume for each brew cycle. |

TROUBLESHOOTING (cont.)

| <u>PROBLEM</u> | <u>PROBABLE CAUSE</u> | <u>REMEDY</u> |
|----------------------------|---|--|
| Dripping from sprayhead. | 1. Brew valve | Repair or replace leaky valve |
| Water overflows filter. | 1. Type of paper filter | BUNN paper filters should be used for proper extraction |
| | 2. No sprayhead | Check sprayhead |
| Beverage overflows server. | 1. Beverage left in server from previous brew | The brew cycle should be started only with an empty server under the funnel. |
| | 2. Brew volume adjustment | Adjust the brew volumes as required to achieve the recommended volume for each brew cycle. |

TROUBLESHOOTING (cont.)

| <u>PROBLEM</u> | <u>PROBABLE CAUSE</u> | <u>REMEDY</u> |
|----------------|-------------------------|---|
| Weak beverage. | 1. Type of paper filter | BUNN paper filters should be used for proper extraction |
| | 2. Coffee or tealeaves | For coffee, a sufficient quantity of fresh drip or regular grind should be used for proper extraction. For tea, a sufficient quantity of fresh, loose tea leaves should be used for proper extraction. |
| | 3. Sprayhead | Bunn-O-Matic sprayhead should be used to properly wet the bed of ground coffee or tealeaves in the funnel |
| | 4. Funnel Loading | The BUNN paper filter should be centered in the funnel and the bed of grounds or tealeaves leveled by gently shaking. |
| | 5. Water temperature | Empty the server, remove its cover, and place the server beneath the sprayhead. Place empty funnel over the server entrance (not in the funnel rails). Press brew. Check the water temperature immediately below the sprayhead with a thermometer. The reading should not be less than 195°F (90.5° C). |
| | 6. Incorrect recipe | Consider adjusting brew volumes, dilution volumes, dilution delay and pulse brew routines. Contact Bunn-O-Matic for suggestions. |

TROUBLESHOOTING (cont.)

| <u>PROBLEM</u> | <u>PROBABLE CAUSE</u> | <u>REMEDY</u> |
|----------------------------------|-----------------------|---|
| Brewer is making unusual noises. | 1. Solenoids | The mounting screws on the solenoids must be tight or they will vibrate during operation |
| | 2. Plumbing lines | Plumbing lines should not be resting on the countertop. |
| | 3. Water supply | The brewer must be connected to a cold water line. Water pressure to the brewer must not be higher than 90 psi (620 kPa). Install a regulator if necessary to lower the working pressure to approximately 50 psi (345 kPa). |
| | 4. Tank heaters | Remove and clean lime off tank heaters. |

SCHEMATIC WIRING DIAGRAM ITCB-DV

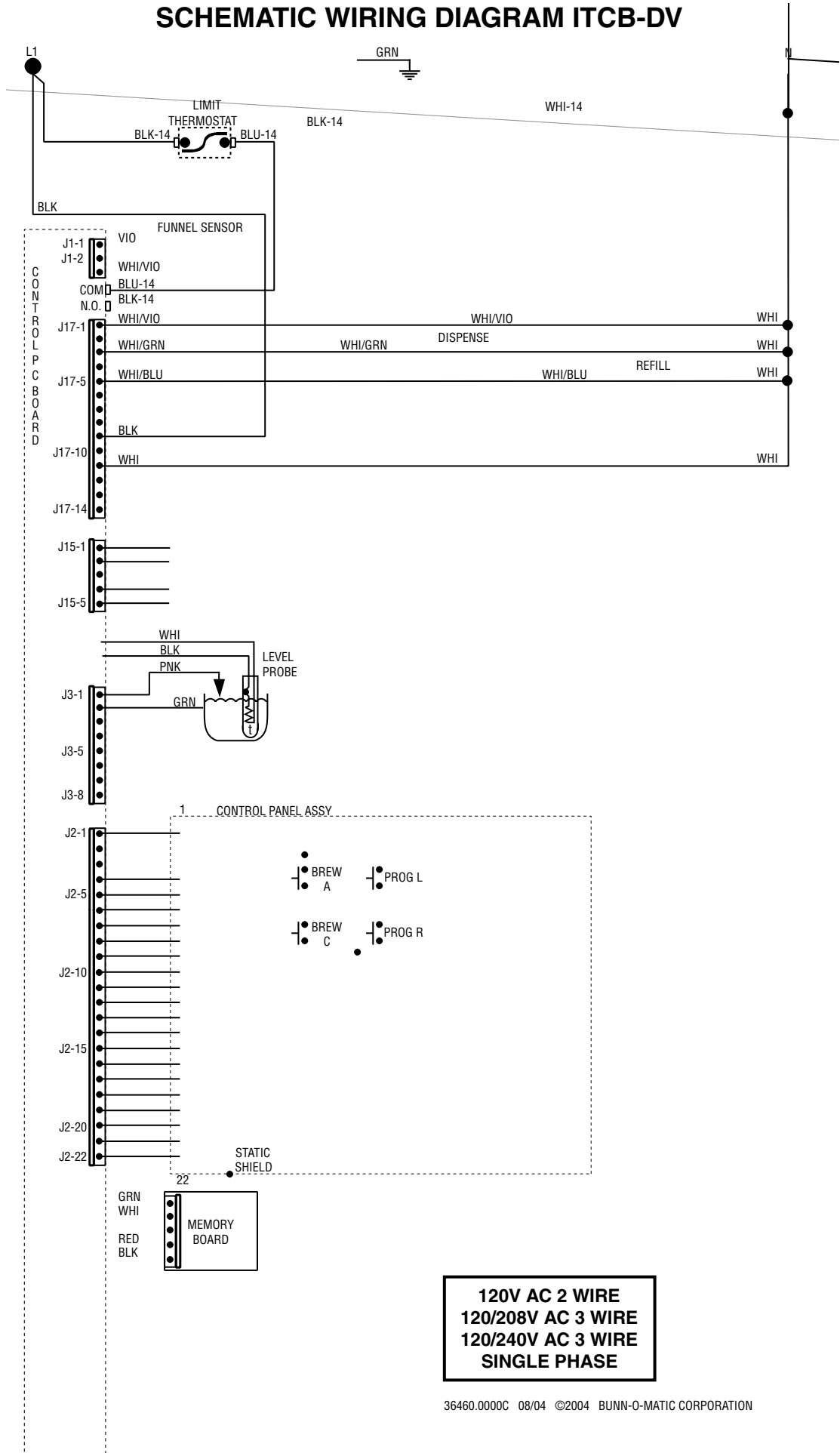

120V AC 2 WIRE
120/208V AC 3 WIRE
120/240V AC 3 WIRE
SINGLE PHASE

SCHEMATIC WIRING DIAGRAM iTCBA, iTCBB

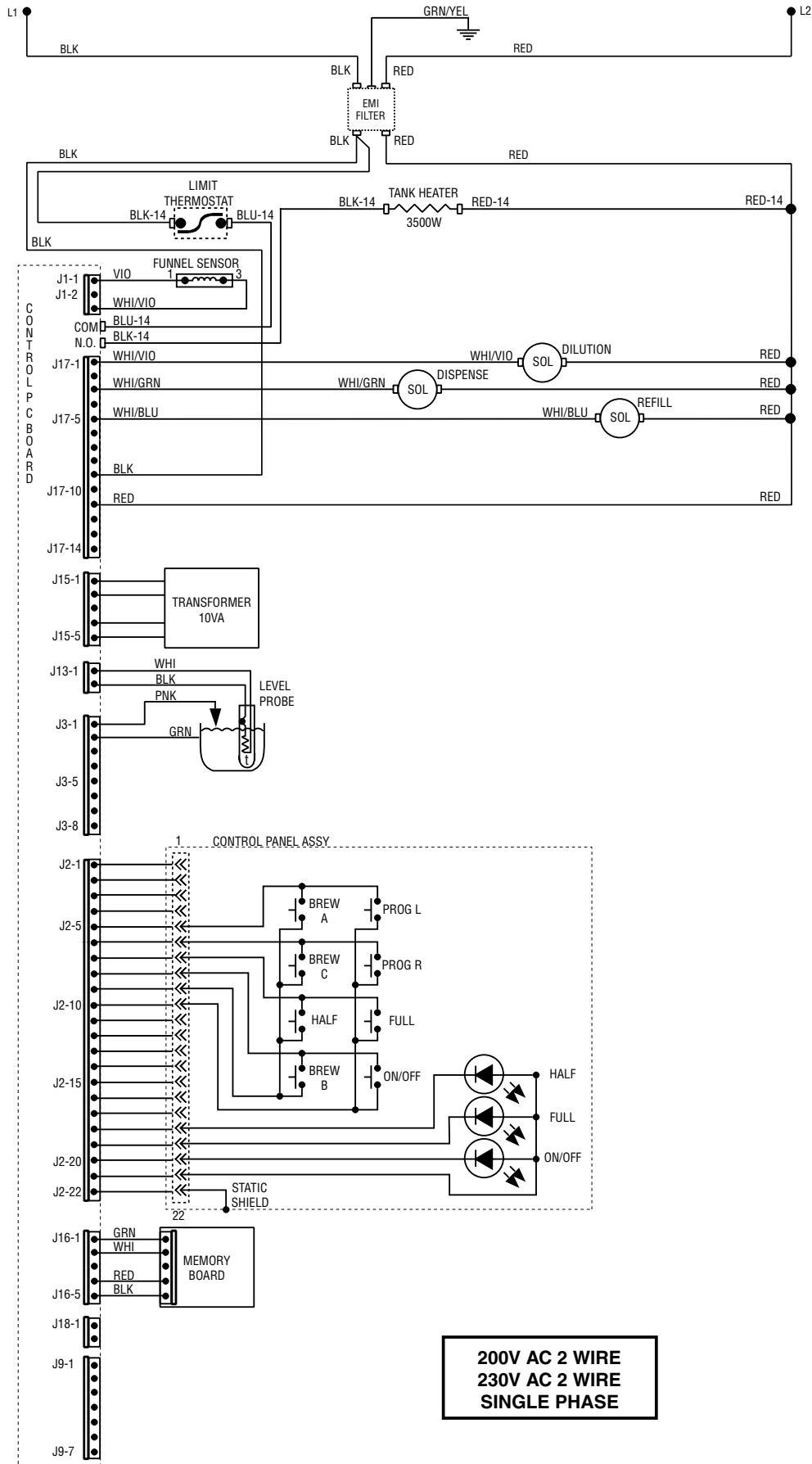

**200V AC 2 WIRE
230V AC 2 WIRE
SINGLE PHASE**

SCHEMATIC WIRING DIAGRAM ITCB-C-DV

