



Emerson[®]

HOME AUDIO SYSTEM

with 3 CD CHANGER

and DIGITAL AM/FM RECEIVER



OWNER'S MANUAL

MS3100

Visit our web site at www.emersonradio.com





BEFORE WE BEGIN

Thank you.....

for purchasing this Emerson audio product. The Emerson brand is your assurance of quality, performance and value.

Our engineers have included many useful and convenient features in this product. Please be sure to read this Owner's Manual completely to make sure you are getting the maximum benefit from each feature.

This product was manufactured using the highest quality components and standards of workmanship. It was tested by Emerson inspectors and found to be in perfect working order before it left our factory. However, there is always the chance that some problem may occur because of rough handling during shipment to the retail store or to the final consumer.

If, after reading this Manual, you experience any problems with the operation of this product, please refer to the instructions for obtaining service at the end of this Manual. Emerson and Emerson retailers are committed to your satisfaction. Once again, thanks for purchasing this Emerson audio product.

For future reference, record the serial number in the space provided.

Model No: MS3100

Serial Number: _____

**WARNING: TO PREVENT FIRE OR SHOCK HAZARD,
DO NOT EXPOSE THIS UNIT TO RAIN OR MOISTURE.**



CAUTION
RISK OF ELECTRIC SHOCK
DO NOT OPEN



CAUTION: TO REDUCE THE RISK OF ELECTRIC SHOCK,
DO NOT REMOVE COVER (OR BACK). NO USER
SERVICEABLE PARTS INSIDE. REFER SERVICING TO
QUALIFIED SERVICE PERSONNEL.



DANGEROUS VOLTAGE

Uninsulated Dangerous Voltage that may be of sufficient magnitude to constitute a risk of electric shock to persons is present within this product's enclosure.



ATTENTION

The Owner's Manual contains important operating and maintenance instructions.

For your safety, it is necessary to refer to the manual.



IMPORTANT NOTES

CLASS 1 LASER PRODUCT

CLASS 1 LASER PRODUCT
APPAREIL À LASER DE CLASSE 1
PRODUCTO LASER DE CLASE 1

CAUTION
INVISIBLE LASER RADIATION
WHEN OPEN AND INTERLOCKS
DEFEATED.
AVOID EXPOSURE TO BEAM



This product contains a low power Laser Device.

- Avoid installing this unit in places exposed to direct sunlight or close to heat radiating appliances such as electric heaters, on top of other stereo equipment that radiates too much heat, places lacking ventilation or dusty areas, places subject to constant vibration and/or humid or moist areas.
- Operate controls and switches as described in the manual.
- Before turning on the power, make certain that the connecting cords and power cord are properly installed.
- When moving the set, be sure to first disconnect the power cord and remove cords connected to other equipment.

FCC INFORMATION

This equipment has been tested and found to comply with the limits for a class B digital Device, pursuant to part 15 of the FCC Rules. These limits are designed to provide reasonable protection against harmful interference in a residential installation. This equipment generates, uses, and can radiate radio frequency energy and, if not installed and used in accordance with the instructions, may cause harmful interference to radio communications. However, there is no guarantee that interference will not occur in a particular installation. If this equipment does cause harmful interference to radio or television reception, which can be determined by turning the equipment off and on, the user is encouraged to try to correct the interference by one or more of the following measures:

- Reorient or relocate the receiving antenna.
- Increase the separation between the equipment and receiver.
- Connect the equipment into an outlet on a circuit different from that to which the receiver is connected.
- Consult the dealer or an experienced radio/TV technician for help.

This device complies with part 15 of the FCC Rules. Operation is subject to the following two conditions:

- (1) This device may not cause harmful interference, and
- (2) This device must accept any interference received, including interference that may cause undesired operation.

PREPARATION FOR USE

UNPACKING AND SET-UP

- Carefully remove the unit from the carton and remove all packing material from the unit.
- Remove any labels or stickers which may be on the front or top of the set, but do not remove any labels from the back or bottom.
- We suggest that you retain the original carton and packing materials in case it ever becomes necessary to return your unit for service. This is the only sure way to protect the unit from damage in transit.
- If you do dispose of the carton and packing materials, please do so properly.

POWER SOURCE

This system is designed to operate on 120V 60Hz AC house current. Connecting this system to any other power supply could result in damage to the unit which is not covered by your warranty. You will note that this system is equipped with a polarized AC power plug having one blade wider than the other. This is a safety feature. If this plug does not fit into your existing AC outlet, do not try to defeat this safety feature by filing the wide blade to make it fit into your outlet. If this plug will not fit into your outlet, you probably have an outdated non-polarized AC outlet. You should have your outlet changed by a qualified licensed electrician.

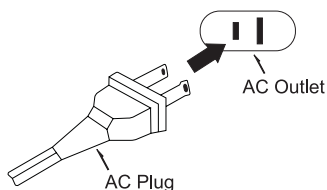

AC Operation

1. Unwind the AC Power Cord completely.
2. Insert the plug into any convenient 120V 60Hz AC outlet.

BATTERY PRECAUTIONS

Follow these precautions when using batteries in this device:

1. Use only the size and type of batteries specified.
2. Be sure to follow the correct polarity when installing the batteries as indicated in the battery compartment. Reversed batteries may cause damage to the device.
3. Do not mix different types of batteries together (e.g. Alkaline and Carbon-Zinc) or old batteries with fresh ones.
4. If the device is not to be used for a long period of time, remove the batteries to prevent damage or injury from possible battery leakage.
5. Do not try to recharge batteries not intended to be recharged; they can overheat and rupture. (Follow battery manufacturer's directions.)

Installation

For **shelf mounting**, extend the left and right flaps at the back of the unit and place it on a strong flat surface.

Note - Leave at least 6 inches (15cm) above the unit for the door to open without being obstructed.

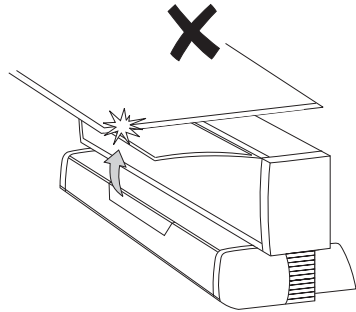

Finally, position the speakers to the left and right of the unit.

Connections

Connect the speakers to the red and black terminals on the back of the unit as shown below. (Hold down red or black terminal flap, insert wire, release flap.)

TO RIGHT
SPEAKER

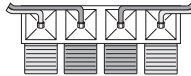

TO LEFT
SPEAKER

Optional: connect any additional equipment to the back panel sockets as follows:

- ◆ Plug your *playback equipment (e.g. MiniDisc or cassette player) into the **AUX** sockets.
- ◆ Plug your recording equipment (e.g. MiniDisc or cassette recorder) into the **LINE OUT** sockets.

*Other examples of playback equipment may include your TV, video recorder or satellite receiver, your computer or games console, or DVD/DAT player.

Always refer to the equipment manufacturer's instructions.

FM antenna wire

The single trailing wire from the unit is the *FM antenna*. This should be positioned for best FM reception (do this when you're tuning - in to radio stations—see page 18).

Installing the remote control batteries

At the back of the remote, press the indented area  and slide open the battery compartment.

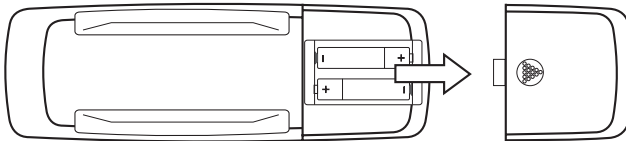

Install 2 batteries type AA (not included). Make sure the direction of the batteries is as shown above.

Once the batteries are inserted, replace the battery cover.

If the remote stops working, it's most likely that the batteries need replacing. Always use leakproof batteries.



Dispose of old batteries safely. **Do not throw them in the fire.**

If you're not using the remote for a few weeks or more, remove the batteries.

Note—Most functions can be operated by the remote. However, the controls are also present on the front panel (below the flap). In general you shouldn't need to lower the flap unless you lose the remote.

Ready to switch on

Plug the unit into the AC outlet.

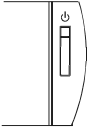

On the front panel, the light above the **POWER** button  will be red to indicate that the unit is in **standby**. (*Standby* means plugged-in but not switched on.)

Switch the unit **on** by pressing the **POWER** button . The red light will change to *green*.

(To switch the unit back to standby, simply press  again.)

The unit is now ready to use.

Note—If necessary, peel off the label entitled 'IMPORTANT NOTES' on the outside of the CD door.

Cleaning & Maintenance

This unit is maintenance free - **do not use oil or other lubricants on any of the moving parts.**

You may clean the main unit and speakers' cabinets periodically using a slightly dampened cloth.

Setting the clock

1. Press \cup to switch the unit on.
2. Press the **AUX** button. (Note the time setting appears at the centre of the display.)
3. Press **MEMORY** so that the **hour** setting flashes, then immediately press **+** or **-** to set the correct hour.

*Note – check the **AM / PM** indicator (to the left of the hour) to ensure you make the correct setting.*

4. Press **MEMORY** repeatedly so that the **minute** setting flashes, then immediately press **+** or **-** to set the correct minute.

After the display has stopped flashing, the clock is set.

*Note – If ever you find the whole time display is **flashing**, this means that the clock needs to be reset (possibly due to the unit having been disconnected from the AC outlet, or a power interruption).*

General use

All general functions can be operated by the remote. You shouldn't need to lower the front panel flap.

Switch the unit on by pressing .

Selecting the sound source

To select the sound source you wish to listen to, press:

- ◆ **CD / SELECT** to listen to compact disc, or
- ◆ **FM / AM** to listen to radio, or
- ◆ **AUX** to listen to auxiliary equipment connected to the **AUX** jacks.
(See page 4.)

Volume

To adjust the volume, use **VOLUME ▲** or **▼**.

To stop the sound instantly, press **MUTE**. (Press again to restore sound).

Note that mute is indicated by the 3 central rings flashing on the CD door (see right.)

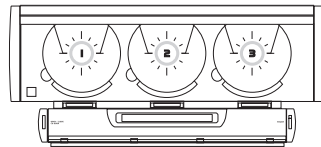

*Note – At minimum volume (or when **MUTE** is pressed), you may find that the sound is not completely silenced. This is perfectly normal.*

Headphones

For private listening, plug a pair of stereo headphones into the **PHONES** socket on the lower left side panel.

When headphones are plugged in, the speakers are switched off automatically.

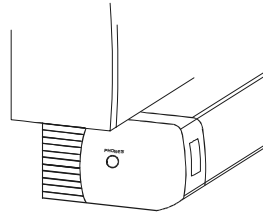

Graphic equalizer

The graphic equaliser (**EQ**) adjusts the character of the sound. It provides a range of four tonal shapes: flat, rock, classic and pop.

Press **EQ** repeatedly to set the graphic equaliser according to your taste or the style of music being played. The selected setting: *FLAT*, *ROCK*, *CLASSIC* or *POP* appears at the bottom right of the display.

Switching off

To switch off to standby, press .

*Note—This unit is intended to be switched off to **standby**. If you unplug the unit, you will lose all clock and timer settings together with any radio stations you have stored in the unit's memory.*

When the unit is in standby, a small amount of current continues to flow. If you intend not to use the unit *for a long period of time*, it is recommended that you disconnect it from the AC outlet (see note above, however).

CD operation

All CD functions can be operated by the remote. You shouldn't need to lower the front panel flap.

Switch the unit on and press **CD / SELECT**.

Important

Never open or close the CD door rapidly by hand - doing so will damage the mechanism.

In an emergency situation (eg.a power cut) where you have no option other than to open or close the door by hand, do so **very slowly and very gently**. *APPLY ONLY LIGHT PRESSURE - NEVER USE FORCE ON THE DOOR.*

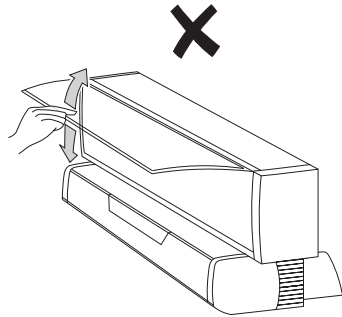

Loading and removing discs

Always load discs with the printed side facing towards you.

1. Press **▲** and the CD door will open automatically.
2. Take the disc out of its case, handling it by the edges.
3. Load the disc onto one of the three players (see note below).

Note—To load a disc, place it onto the centre spindle of the player in the same way that you'd put a disc back in its case.

4. Press **▲** to close the CD door.

To **eject**, simply open the CD door using ▲ and remove the disc. Note there's a cutout to the left of each player so that you can place your finger under the edge of the disc to remove it.

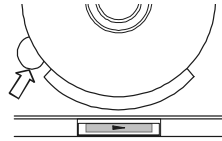

Playing one disc

1. Load the disc as previously shown.
2. Press one of the three ► buttons below the disc you wish to play:



(Alternatively, press one of the CD buttons on the remote.)



The number of the disc playing (❶ or ❷ or ❸) is indicated at the left of the front panel display.

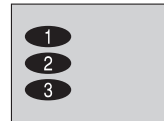

Selecting tracks

To change track while a disc is playing, press and release ◀◀ or ▶▶ .

Alternatively, you can pick a track number directly using buttons 1 to 9 on the remote.

If the required track number is higher than 9, use the +10 button.

*Examples: To select track 10 press +10 then 0.
To select track 23 press +10 twice then 3.*

Searching tracks

To search *within* tracks while a disc is playing, hold in the ◀◀ or ▶▶ button.

Pause and stop

- ◆ To **pause** during play, press ▶|| (press again to resume play).
- ◆ To **stop** play, press ■ .

Repeat play

You can repeat all discs, one disc, or just one track. To select the mode you require, press **REPEAT** until the top-left of the display indicates one of the following:

REPEAT ALL DISC
REPEAT 1 DISC
REPEAT 1 TRACK

To **cancel** repeat play, press **REPEAT** until the word *REPEAT* disappears from the display.

Random play

You can play tracks in random order (from one disc or all discs).

To select the mode you require, press **RANDOM** until the top left of the display indicates one of the following:

RANDOM ALL DISC
RANDOM 1 DISC

To **cancel** random play, press **RANDOM** until the word *RANDOM* disappears from the display.

Playing all discs

1. Load the discs as shown earlier.

Note that discs will be played **in order**. If you *don't* want to start with disc **1** press **CD / SELECT** to select **2** or **3** (indicated at the left of the front panel display).

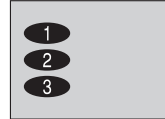

2. Press **▶||** to start play.
 - ♦ To select tracks or pause, stop, etc, use buttons **◀◀**, **▶▶**, **▶||** and **■** (see page 11).
 - ♦ For **repeat** and **random** play, see previous page.

Playing a programmed selection of tracks

You can program the unit to play a selection of tracks from the discs loaded. (Up to 40 tracks can be programmed.)

Note you can abandon programming at any time by pressing ■ .

1. Load the disc(s).

*Note – When you press **PROG** to start programming, the front panel will display **P - 01** - this means programmed track 1. Note that **TRACK 00** flashing next to **P - 01** is telling you to enter the CD and track number for programmed track 1.*

2. Press **PROG**.
3. Press **CD / SELECT** to select disc **1** or **2** or **3** (on the front panel display).

4. Press ◀◀ or ▶▶ to select the TRACK number on that disc. (To select all tracks on the disc, press ◀◀ or ▶▶ so that *TRACK ALL* is displayed.)
5. Repeat steps 2, 3 and 4 for each programmed track. (Note that *P - 0 1* advances to *P - 0 2*, *P - 0 3* etc as you program each track.)
 - ◆ You can **check** your program by pressing **PROG** repeatedly. As *P - 0 1*, *P - 0 2* advances, check the displayed disc and track numbers. (Note after the *final* track, the display flashes *TRACK 0 0*; pressing **PROG** again will return to the *first* track.)
6. Finally, press ▶|| to play the program.

After the program has stopped, you may press ▶|| to play the whole program again.

- ◆ To set the program to repeat continuously, press **REPEAT** so that *REPEAT* is displayed. (To cancel repeat, press **REPEAT** so that *REPEAT* disappears.)

*Note—You cannot set a program to **random** play.*

Editing the program

Before editing, make sure no disc is playing.

- ♦ To **change** a track, press **PROG** repeatedly (until the required *P* - number is displayed) then press **◀◀** or **▶▶** to change the *TRACK* number.
- ♦ To **delete** a track, press **PROG** repeatedly (until the required *P* - number is displayed) then press **◀◀** or **▶▶** to change the *TRACK* number to - - .
- ♦ To **add** a track, press **PROG** repeatedly (until *TRACK 0 0* flashes) then use **CD / SELECT** and **◀◀** or **▶▶** to select required disc and *TRACK* number.

Clearing the program

To clear the program, stop any disc playing first, then press **■** once play has stopped.

Note—The program will be cleared if the CD door is opened.

- ♦ If you **don't** want to clear the program but wish to play one of the loaded discs normally, simply press one of the three **▶** buttons below the players:



(Alternatively, press one of the CD buttons on the remote.)



Additional CD functions

Track introductions

If **INTRO** is pressed (instead of ►||) to start play, only the first 10 seconds of each track will be played. This enables you to scan through a CD (or a programmed selection of tracks) automatically.

The introduction feature can also be used to help you search for a track-when you hear the track you require, press **INTRO** again and that track will continue playing.

Track/time displays

- ◆ When all discs are *stopped*, the display shows the **total playing time** of the currently selected disc.
- ◆ When a disc is *playing*, the display shows the elapsed time of the **current track**.
- ◆ When a disc is playing, pressing **MODE** (REMAIN) once to display the **remaining** time of the current track; pressing again displays the remaining time of the whole disc.
- ◆ To display the **current time** (when all discs are stopped), press **MODE** once. To display current time during play, press **MODE** 4 times.

*Note—Press **MODE** repeatedly also displays any **TIMER ON** and **TIMER OFF** settings. These are explained on page 20.*

Instant play

If you are listening to **radio** or auxiliary input, you can instantly play a disc simply by pressing one of the three ► buttons below the players:



(Alternatively, press one of the CD buttons on the remote.)



Radio operation

All radio functions can be operated by the remote. You shouldn't need to lower the front panel flap.

Tuning-in a new radio station

Pressing **BAND** selects radio operation. The display indicates the tuning frequency, and just to the right of it, the band: *F^m*, or *A^m*. Repeatedly pressing **BAND** changes the band.

Having selected the required band, tune-in to a radio station in either of the following ways:

- ♦ To search up or down the band for a station, hold in + or - for two seconds then release.
- ♦ To **change frequency one step at a time**, repeatedly press and release + or - .

You can keep any new station you've tuned-in by **storing** it in the memory (see below.)

Note—For best FM reception, position the trailing FM antenna wire for least interference. (Note if AM reception is poor, you may need to rotate the unit.)

Storing radio stations in memory

You can store up to 20 radio stations on each band.

1. Tune in to the station you wish to store (as described above).
2. Decide on the memory number you will use for this station, for example 2.

- Press **MEMORY** followed by **MEM▲** or **MEM▼** so that the memory number flashes to the left of the frequency, for example:
MEMORY CH 02 89.1 MHz FM. After a few seconds the flashing stops and the memory number is set.

*Note—Instead of using **MEM▲** and **MEM▼** you can use the number keys on the remote. In the above example, you would press **MEMORY** followed by **2**.*

Note after pressing **MEMORY** you must enter a memory number *within 5 seconds*, otherwise the number will not be stored.

Selecting stored radio stations

- Press **BAND** to select required band.
- Press **MEM▲** or **MEM▼** to select required memory number.

Alternatively, you can use the number keys on the remote.

*Examples: For memory 7, simply press 7.
For memory 14, press + 10 then 4.
For memory 20, press + 10 twice then 0.*

FM mono/stereo

You can set FM radio stations to mono (for example if FM stereo reception is noisy). To switch between FM mono and stereo, lower the front panel flap and press **FM MONO/STEREO**.

Time display

To display the current time, press **MODE** once.

*Note—pressing **MODE** repeatedly also displays any **TIMER ON** and **TIMER OFF** settings. These are explained on the next page.*

Timer operation

The timer function allows you to set the unit to switch itself on and off automatically, for example, to wake you up each morning.

While setting up the timer, make sure you carry out each step within five seconds, otherwise your entry will not be accepted in the memory and you will have to start again.

Note-During timer setup, always check the AM/PM indicator (to the left of the time) to ensure you make the correct settings.

1. Select the radio station or CD you wish to play when the unit switches on. (For CD this can be a programmed selection of tracks if desired.)
2. Press **MODE** repeatedly until *TIMER ON* flashes at the right of the display, then press **MEMORY** immediately.

The **timer on** (*hour* setting) will flash.

3. Immediately press + or - to set the hour, then press **MEMORY** .

The *minute* setting will flash.

4. Immediately press + or - to set the minute, then press **MEMORY** .

5. Press **MODE** repeatedly until *TIMER OFF* flashes at the right of the display, then press **MEMORY** immediately.

The **timer off** (*hour* setting) will flash.

6. Immediately press + or - to set the hour, then press **MEMORY** .

The *minute* setting will flash.

7. Immediately press + or - to set the minute, then press **MEMORY** .

The timer on and off times have now been set. To check them at any time, press **MODE** repeatedly to step through the *TIMER ON* and *TIMER OFF* settings on the display.

8. To **activate** the timer, lower the front panel flap and press **TIMER** so that *TIMER* appears at the right of the display.
9. Press **⏻** to switch off the unit to standby.

Timer operation is now set. The unit will switch itself on and off at the set times every day.

*Note—If ever you find the whole time display **flashing**, the clock needs to be reset (see page 7). This could be due to the unit having been disconnected from the AC outlet, or a power interruption.*

Cancelling timer operation

If you don't want the unit to switch itself on, for example at weekends, press **TIMER** (inside front panel flap) so that the word *TIMER* is not displayed. (The timer settings are still retained for the next time you wish to activate the timer.)

To **reactivate** the timer, repeat step 8 above.

Sleep timer

The unit has a sleep timer. Activating it will make the unit will switch itself off after 90 minutes.

To activate the sleep timer, lower the front panel flap and press **SLEEP** so that *SLEEP* appears toward the right of the display.

To **cancel** the sleep timer, press **SLEEP** so that so that the word *SLEEP* is not displayed.



CARE AND MAINTENANCE

There are no user serviceable parts inside the unit. Do not attempt any adjustments other than those described in the manual. Refer all other problems to qualified service personnel.

Compact Disc Care

- To remove a disc from its storage case, press down on the centre of the case and lift the disc out, holding it carefully by the edges.
- Treat the disc carefully. Handle the disc only by its edges. Never allow your fingers to come in contact with the shiny, unprinted side of the disc.
- Do not attach any tape, stickers, etc. to the disc label.
- Clean the disc periodically with a soft, lint-free, dry cloth. Never use detergents or abrasive cleaners to clean the disc. If necessary, use a CD cleaning kit.
- If a disc skips or gets stuck on a section of the disc, it is probably dirty or damaged (scratched).
- When cleaning the disc, wipe in straight lines from the center of the disc to the outer edge of the disc. Never wipe in circular motions.

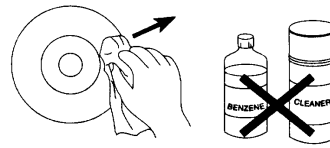
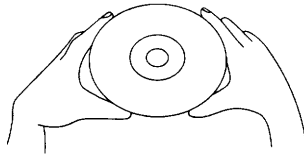
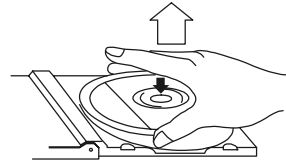
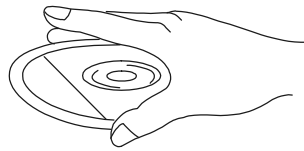

If the cabinet becomes dusty, wipe it with a soft cloth. If the cabinet becomes smudged or dirty, clean it with a soft, slightly dampened cloth. Never allow water or any liquid to get inside the cabinet. Never use any abrasive cleaners or cleaning pads as these will damage the finish of your radio.

 Emerson SERVICE	TO FIND THE LOCATION AND PHONE NUMBER OF YOUR NEAREST SERVICE CENTER PERMITTED TO PERFORM WARRANTY...
CALL TOLL FREE: 1-800-695-0098	
FOR ADDITIONAL SET-UP OR OPERATING ASSISTANCE PLEASE CALL: 1-800-898-9020	
FOR CUSTOMER SERVICE, PLEASE WRITE TO: Emerson Radio Corp. Consumer Affairs Dept. 1901 Diplomat Drive, Farmers Branch, TX 75234.	

WALL MOUNTING INSTRUCTIONS

If you decide to wall mount your MS3100 audio system, please read and carefully follow these instructions:

General Precautions and Recommendations

- * When choosing a location for wall mounting remember that the main unit must be connected to an AC outlet. The AC power cord of the main unit should be able to hang straight down from the main unit to the AC outlet. See Figure 1.

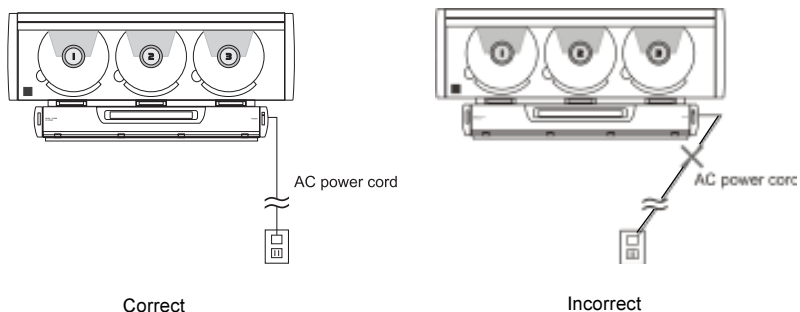
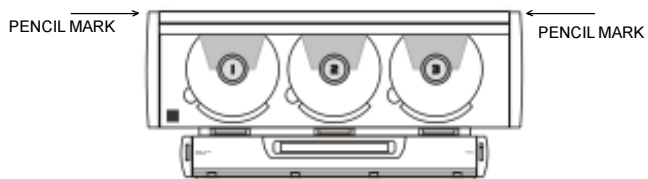

Figure 1

Connect the main unit to the AC outlet and position it against the wall in the desired location. Make sure the plug remains firmly and fully inserted into the outlet. There should be just enough slack in the power cord so that the plug can be easily removed from, and reconnected to the AC outlet.

- * Make pencil marks on the wall to indicate the top of the cabinet.



- If there is no AC outlet directly below the desired mounting location, you may use a UL approved extension cord. In this case you should allow the AC plug of the main unit to reach all the way to the floor and connect the extension cord on the floor, not above the floor. See Figure 2.

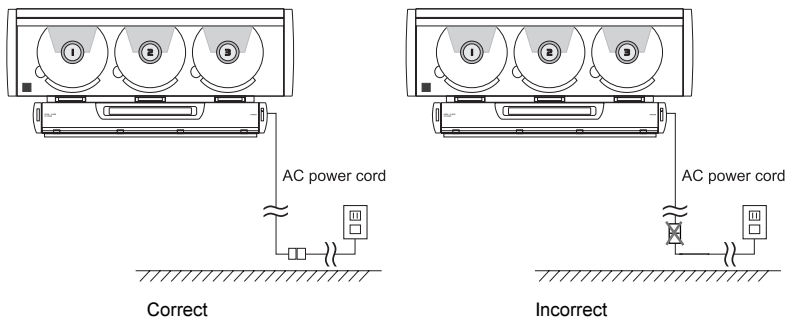

Figure 2

- Although all major functions of this system, including opening/closing the front cover, can be operated by the remote control, you must still load and unload your CDs manually. Therefore the main unit should be mounted at a height that is convenient and comfortable for changing discs.
- **IMPORTANT.** The front cover requires 6" clearance to open fully. If you plan to mount the unit under a shelf, in a cabinet, etc, you must allow at least 6" clearance above the unit so that the door can open completely without obstruction. If the front cover encounters some obstruction as it is opening, the motor will reverse automatically and the door will close immediately. Be sure to follow the instructions on the template carefully for best results.

TEMPLATE INSTRUCTIONS

- 1) Select the desired location for wall mounting after carefully reviewing the "General Precautions and Recommendations" of the wall mounting instructions.
- 2) Tape the template to the wall, or other surface, in the desired location. Align the dotted line on the template with the pencil marks you made on the wall. Be sure to allow at least 6" clearance above the main unit, as indicated on the template, for the CD door to open fully.
- 3) Make sure the template is level.
- 4) Use an awl, ice pick, a nail or similar pointed tool, and push through the template to make a small starter hole in the wall surface as indicated by the "Drill Hole Here" marks. Then remove the template from the wall.

- 5) Before You Drill: Make sure there are no water pipes, gas pipes, electrical wires or other obstructions or hazards behind the wall in your chosen mounting location. If you are not sure about this, and don't know how to check, perhaps you should consider having the system mounted by someone with the necessary experience.
- 6) Use a 3/16" drill bit in your electric drill and drill completely through the drywall.

NOTE: The hollow wall plastic anchors included with this system are intended for installation in normal 5/8" drywall (sheetrock, plasterboard, etc). If you are installing this system on a solid wall surface such as wood, concrete, cinderblock, brick, etc. you cannot use these hollow wall anchors. In this case you must use the appropriate solid wall anchors, (not included), available at your local hardware store or home improvement center.

- 7) Insert the tip of the plastic anchor into the hole and use a hammer to tap the anchor all the way in until it is flush with the wall surface.

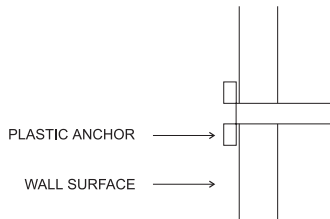

- 8) Insert the screw into the anchor and tighten the screw until it touches the collar on the plastic anchor. This causes the anchor to spread inside the wall and locks the anchor in place.

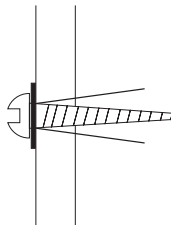

- 9) Loosen the screw until there is a gap about 1/8" between the screw head and the wall .

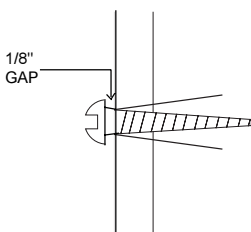

- 10) Position the main unit over the two screw heads so that the heads of the screws fit into bottom of each "Keyhole" on the back cabinet. When the two screw heads are inside the keyholes, slide the main unit slightly downward until each screw head is in the top of the keyhole.



Insert screw heads into keyhole



Slide unit downward to lock unit in position

If the main unit is still loose, you probably left too large a gap between the screw head and the wall. Slide the unit slightly upward and take it off the mounting screws. Tighten one or both screws slightly and remount the unit. It should fit snugly against the wall and not move when you are loading or unloading CDs.

Follow a similar procedure to mount each speaker.

NOTE: It will be necessary to remove the main unit from the wall to connect the speaker wires. If there is any excess speaker wire hanging between the main unit and the speakers, remove the speaker from the wall and push the excess wire into the back of the speaker cabinet, then remount the speakers.

NOTE: You can also purchase plastic cord covers at most home improvement centers. These covers can easily be cut to any desired length and attached to the wall to conceal the speaker wires and AC power cord if necessary. The covers can also be painted or wall papered to match the surrounding wall surface.



EMERSON RADIO CORP. LIMITED WARRANTY

What does this warranty cover ? Any manufacturing defects in original material, including original parts and workmanship, under normal use and conditions.

For how long? For a period of ninety (90) days from the date of original purchase in the U.S.

What will we do ? If you need service under this Warranty, and you provide us with the dated proof of purchase, we will provide repair service at no charge for labor and parts at an authorized Depot Repair Facility, or replace the product in our discretion.

How do you make your warranty claim ? If it becomes necessary to repair your unit, you can obtain the name and mailing location of a Depot Repair Facility by dialing **1-800-695-0098**. You should pack your unit in a well-padded heavy corrugated box, enclose your check or money order payable to the Depot Repair Facility in the amount of **\$9.00** to cover the return shipping and handling costs, and enclose a copy of your proof of purchase (warranty service will not be provided without a dated proof of purchase). Finally, you should ship the unit prepaid via UPS or parcel post (insured).

What does your warranty not cover ? Your warranty does not cover the following :

- Damage from negligence, misuse, abuse, accident, or failure to follow operating instructions.
- Use of product in a commercial application or rentals.
- Changes or repairs by anyone other than an authorized Depot Repair Facility.
- Damage because your unit is improperly connected to the equipment of other manufacturers.
- Unit on which the serial number has been defaced, modified or removed.
- Damage to equipment not properly connected to the product.
- Cost incurred in shipping your unit to and from an authorized Depot Repair Facility.
- Ordinary adjustments which you can perform as outlined in the owner's manual.
- Signal reception problems caused by external antenna or cable systems.
- Products purchased, used, serviced, or damaged outside of the United States.
- Damage to compact discs or cassettes.

What other limitations apply to your warranty ?

THIS WARRANTY IS NON-TRANSFERABLE AND APPLIES ONLY TO THE ORIGINAL PURCHASER AND DOES NOT EXTEND TO SUBSEQUENT OWNERS OF THE PRODUCT. THIS WARRANTY IS VALID ONLY IN THE UNITED STATES OF AMERICA. ANY APPLICABLE IMPLIED WARRANTIES, INCLUDING THE WARRANTY OF MERCHANTABILITY, ARE LIMITED IN DURATION TO A PERIOD OF THE EXPRESSED WARRANTY AS PROVIDED ABOVE BEGINNING WITH THE DATE OF ORIGINAL PURCHASE AT RETAIL AND NO WARRANTIES, WHETHER EXPRESSED OR IMPLIED, SHALL APPLY TO THE PRODUCT THEREAFTER. WE MAKE NO WARRANTY AS TO THE FITNESS OF THE PRODUCT FOR ANY PARTICULAR PURPOSE OR USE.

THE EXTENT OF OUR LIABILITY UNDER THIS LIMITED WARRANTY IS THE REPAIR OR REPLACEMENT PROVIDED ABOVE AND IN NO EVENT WILL OUR LIABILITY EXCEED THE PURCHASE PRICE PAID BY THE PURCHASER OF THE PRODUCT. UNDER NO CIRCUMSTANCES WILL WE BE LIABLE FOR ANY LOSS, DIRECT, INDIRECT, INCIDENTAL, SPECIAL, OR CONSEQUENTIAL DAMAGE ARISING OUT OF OR IN CONNECTION WITH THE USE OF THIS PRODUCT.

How does state law apply to your warranty ?

THIS WARRANTY GIVES YOU SPECIFIC LEGAL RIGHTS, BUT YOU MAY ALSO HAVE OTHER RIGHTS WHICH VARY FROM STATE TO STATE. SOME STATES DO NOT ALLOW LIMITATIONS ON IMPLIED WARRANTIES OR EXCLUSION OR LIMITATION OF INCIDENTAL OR CONSEQUENTIAL DAMAGE, SO THESE RESTRICTIONS MAY NOT APPLY TO YOU.

AU898F



EMERSON RADIO CORP.



EMERSON
Part No.: 16-2837
110-01

Printed in China

