

# OPERATOR'S MANUAL

**18V/24V MaxSelect™**  
**1/4 in. IMPACT DRIVER**  
**R8823**

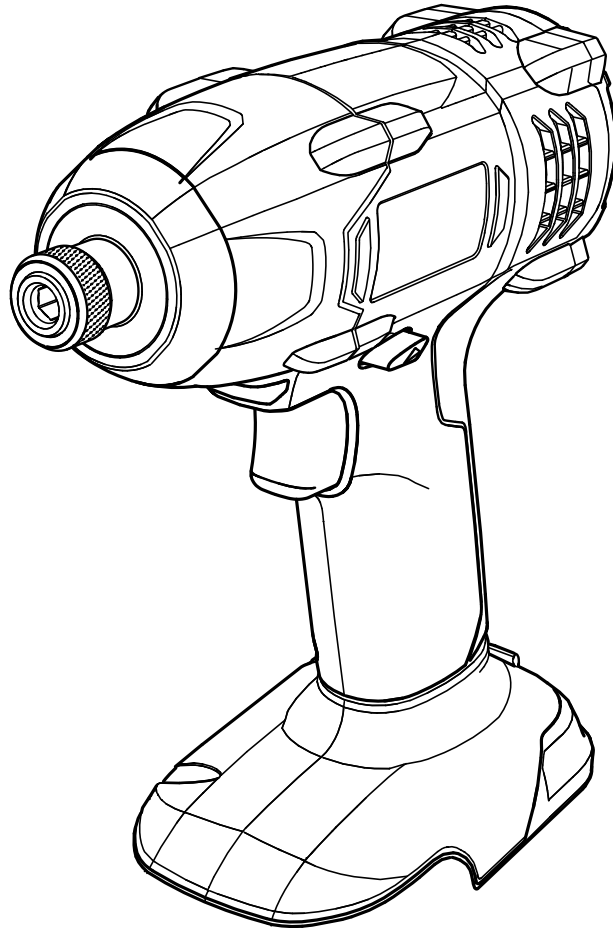

**NEW LITHIUM-ION BATTERY PACKS  
MUST BE CHARGED BEFORE FIRST USE**  
**BATTERIES AND CHARGERS SOLD  
SEPARATELY**

Your impact driver has been engineered and manufactured to our high standards for dependability, ease of operation, and operator safety. When properly cared for, it will give you years of rugged, trouble-free performance.

---

**⚠ WARNING:**

To reduce the risk of injury, the user must read and understand the operator's manual before using this product.

---

Thank you for buying a RIDGID product.

**SAVE THIS MANUAL FOR FUTURE REFERENCE**

# TABLE OF CONTENTS

---

■ Introduction .....	2
■ General Safety Rules .....	3-4
■ Specific Safety Rules.....	4
■ Safety Rules for Charger .....	5
■ Symbols.....	6-7
■ Features.....	8-9
■ Assembly .....	9
■ Operation.....	10-17
■ Maintenance .....	18
■ Warranty .....	19
■ Customer Service Information.....	Back Page

## INTRODUCTION

---

This tool has many features for making its use more pleasant and enjoyable. Safety, performance, and dependability have been given top priority in the design of this product making it easy to maintain and operate.

---

### **WARNING:**

Some dust created by power sanding, sawing, grinding, drilling, and other construction activities contains chemicals known to cause cancer, birth defects, or other reproductive harm. Some examples of these chemicals are:

- lead from lead-based paints,
- crystalline silica from bricks and cement and other masonry products, and
- arsenic and chromium from chemically-treated lumber.

Your risk from these exposures varies, depending on how often you do this type of work. To reduce your exposure to these chemicals: work in a well ventilated area, and work with approved safety equipment, such as those dust masks that are specially designed to filter out microscopic particles.

---

# GENERAL SAFETY RULES

## WARNING!

**Read all instructions.** Failure to follow all instructions listed below may result in electric shock, fire and/or serious injury. The term “power tool” in all of the warnings listed below refers to your mains-operated (corded) power tool or battery-operated (cordless) power tool.

## SAVE THESE INSTRUCTIONS

### WORK AREA SAFETY

- **Keep work area clean and well lit.** Cluttered or dark areas invite accidents.
- **Do not operate power tools in explosive atmospheres, such as in the presence of flammable liquids, gases or dust.** Power tools create sparks which may ignite the dust or fumes.
- **Keep children and bystanders away while operating a power tool.** Distractions can cause you to lose control.

### ELECTRICAL SAFETY

- **Power tool plugs must match the outlet. Never modify the plug in any way. Do not use any adapter plugs with earthed (grounded) power tools.** Unmodified plugs and matching outlets will reduce risk of electric shock.
- **Avoid body contact with earthed or grounded surfaces such as pipes, radiators, ranges and refrigerators.** There is an increased risk of electric shock if your body is earthed or grounded.
- **Do not expose power tools to rain or wet conditions.** Water entering a power tool will increase the risk of electric shock.
- **Do not abuse the cord. Never use the cord for carrying, pulling or unplugging the power tool. Keep cord away from heat, oil, sharp edges or moving parts.** Damaged or entangled cords increase the risk of electric shock.
- **When operating a power tool outdoors, use an extension cord suitable for outdoor use.** Use of a cord suitable for outdoor use reduces the risk of electric shock.
- **Use battery only with charger listed.**

MODEL	BATTERY PACK	CHARGER
R8823	(18V) 130254007	(18V) 140276003 or 140276004
	(24V) 130377001 (R85008)	(24V) 140315001 (R85009)

### PERSONAL SAFETY

- **Stay alert, watch what you are doing and use common sense when operating a power tool. Do not use a power tool while you are tired or under the influence of drugs, alcohol or medication.** A moment of inattention while operating power tools may result in serious personal injury.
- **Use safety equipment. Always wear eye protection.** Safety equipment such as dust mask, non-skid safety shoes, hard hat, or hearing protection used for appropriate conditions will reduce personal injuries.

- **Avoid accidental starting. Ensure the switch is in the off-position before plugging in.** Carrying power tools with your finger on the switch or plugging in power tools that have the switch on invites accidents.
- **Remove any adjusting key or wrench before turning the power tool on.** A wrench or a key left attached to a rotating part of the power tool may result in personal injury.
- **Do not overreach. Keep proper footing and balance at all times.** This enables better control of the power tool in unexpected situations.
- **Dress properly. Do not wear loose clothing or jewelry. Keep your hair, clothing and gloves away from moving parts.** Loose clothes, jewelry or long hair can be caught in moving parts.
- **If devices are provided for the connection of dust extraction and collection facilities, ensure these are connected and properly used.** Use of these devices can reduce dust-related hazards.
- **Do not wear loose clothing or jewelry. Contain long hair.** Loose clothes, jewelry, or long hair can be drawn into air vents.
- **Do not use on a ladder or unstable support.** Stable footing on a solid surface enables better control of the power tool in unexpected situations.

### POWER TOOL USE AND CARE

- **Do not force the power tool. Use the correct power tool for your application.** The correct power tool will do the job better and safer at the rate for which it was designed.
- **Do not use the power tool if the switch does not turn it on and off.** Any power tool that cannot be controlled with the switch is dangerous and must be repaired.
- **Disconnect the plug from the power source and/or the battery pack from the power tool before making any adjustments, changing accessories, or storing power tools.** Such preventive safety measures reduce the risk of starting the power tool accidentally.
- **Store idle power tools out of the reach of children and do not allow persons unfamiliar with the power tool or these instructions to operate the power tool.** Power tools are dangerous in the hands of untrained users.
- **Maintain power tools. Check for misalignment or binding of moving parts, breakage of parts and any other condition that may affect the power tool's operation. If damaged, have the power tool repaired before use.** Many accidents are caused by poorly maintained power tools.
- **Keep cutting tools sharp and clean.** Properly maintained cutting tools with sharp cutting edges are less likely to bind and are easier to control.
- **Use the power tool, accessories and tool bits etc., in accordance with these instructions and in the manner intended for the particular type of power tool, taking into account the working conditions and the work to be performed.** Use of the power tool for operations different from those intended could result in a hazardous situation.

# GENERAL SAFETY RULES

---

## BATTERY TOOL USE AND CARE

- **Ensure the switch is in the off position before inserting battery pack.** Inserting the battery pack into power tools that have the switch on invites accidents.
- **Recharge only with the charger specified by the manufacturer.** A charger that is suitable for one type of battery pack may create a risk of fire when used with another battery pack.
- **Use power tools only with specifically designated battery packs.** Use of any other battery packs may create a risk of injury and fire.
- **When battery pack is not in use, keep it away from other metal objects like paper clips, coins, keys, nails, screws, or other small metal objects that can make a connection from one terminal to another.** Shorting the battery terminals together may cause burns or a fire.
- **Under abusive conditions, liquid may be ejected from the battery, avoid contact. If contact accidentally**

occurs, flush with water. If liquid contacts eyes, additionally seek medical help. Liquid ejected from the battery may cause irritation or burns.

## SERVICE

- **Have your power tool serviced by a qualified repair person using only identical replacement parts.** This will ensure that the safety of the power tool is maintained.

---

### **WARNING!**

To reduce the risk of injury, user must read instruction manual.

- 
- **When servicing a power tool, use only identical replacement parts. Follow instructions in the Maintenance section of this manual.** Use of unauthorized parts or failure to follow Maintenance instructions may create a risk of shock or injury.

## SPECIFIC SAFETY RULES

---

- **Hold power tools by insulated gripping surfaces when performing an operation where the cutting tool may contact hidden wiring or its own cord.** Contact with a “live” wire will also make exposed metal parts of the tool “live” and shock the operator.
- **Wear ear protectors with impact drivers.** Exposure to noise can cause hearing loss.
- **Do not use the impact driver as a drill.** The impact driver is not designed to be used as a drill.
- **Do not drive a screw where there may be hidden wiring behind the surface.** Contact with a “live” wire will make exposed metal parts of the tool “live” and shock the operator.
- **Know your power tool. Read operator’s manual carefully. Learn its applications and limitations, as well as the specific potential hazards related to this tool.** Following this rule will reduce the risk of electric shock, fire, or serious injury.
- **Always wear safety glasses with side shields.** Everyday glasses have only impact resistant lenses. They are NOT safety glasses. Following this rule will reduce the risk of eye injury.
- **Protect your lungs. Wear a face or dust mask if the operation is dusty.** Following this rule will reduce the risk of serious personal injury.
- **Protect your hearing. Wear hearing protection during extended periods of operation.** Following this rule will reduce the risk of serious personal injury.
- **Battery tools do not have to be plugged into an electrical outlet; therefore, they are always in operating condition. Be aware of possible hazards when not using your battery tool or when changing accessories.** Following this rule will reduce the risk of electric shock, fire, or serious personal injury.

- **Do not place battery tools or their batteries near fire or heat.** This will reduce the risk of explosion and possibly injury.
- **Do not crush, drop or damage battery pack. Do not use a battery pack or charger that has been dropped or received a sharp blow.** A damaged battery is subject to explosion. Properly dispose of a dropped or damaged battery immediately.
- **Batteries vent hydrogen gas and can explode in the presence of a source of ignition, such as a pilot light.** To reduce the risk of serious personal injury, never use any cordless product in the presence of open flame. An exploded battery can propel debris and chemicals. If exposed, flush with water immediately.
- **Do not charge battery tool in a damp or wet location.** Following this rule will reduce the risk of electric shock.
- **For best results, your battery tool should be charged in a location where the temperature is more than 50°F but less than 100°F.** To reduce the risk of serious personal injury, do not store outside or in vehicles.
- **Under extreme usage or temperature conditions, battery leakage may occur. If liquid comes in contact with your skin, wash immediately with soap and water, then neutralize with lemon juice or vinegar. If liquid gets into your eyes, flush them with clean water for at least 10 minutes, then seek immediate medical attention.** Following this rule will reduce the risk of serious personal injury.
- **If the power supply cord is damaged, it must be replaced only by the manufacturer or by an authorized service center to avoid risk.**

# SAFETY RULES FOR CHARGER

## WARNING!

### **READ AND UNDERSTAND ALL INSTRUCTIONS.**

Failure to follow all instructions listed below, may result in electric shock, fire and/or serious personal injury.

- **Before using battery charger**, read all instructions and cautionary markings in this manual, on battery charger, battery, and product using battery to prevent misuse of the products and possible injury or damage.

## CAUTION:

To reduce the risk of electric shock or damage to the charger and battery, charge only lithium-ion or nickel-cadmium rechargeable batteries as specifically designated on your charger. Other types of batteries may burst, causing personal injury or damage.

- **Do not use charger outdoors or expose to wet or damp conditions.** Water entering charger will increase the risk of electric shock.
- **Use of an attachment not recommended or sold by the battery charger manufacturer may result in a risk of fire, electric shock, or injury to persons.** Following this rule will reduce the risk of electric shock, fire, or serious personal injury.
- **Do not abuse cord or charger.** Never use the cord to carry the charger. Do not pull the charger cord rather than the plug when disconnecting from receptacle. Damage to the cord or charger could occur and create an electric shock hazard. Replace damaged cords immediately.
- **Make sure cord is located so that it will not be stepped on, tripped over, come in contact with sharp edges or moving parts or otherwise subjected to damage or stress.** This will reduce the risk of accidental falls, which could cause injury, and damage to the cord, which could result in electric shock.
- **Keep cord and charger from heat to prevent damage to housing or internal parts.**

- **Do not let gasoline, oils, petroleum-based products, etc. come in contact with plastic parts.** They contain chemicals that can damage, weaken, or destroy plastic.

- **An extension cord should not be used unless absolutely necessary.** Use of improper extension cord could result in a risk of fire and electric shock. If extension cord must be used, make sure:

- a. That pins on plug of extension cord are the same number, size and shape as those of plug on charger.
- b. That extension cord is properly wired and in good electrical condition; and
- c. That wire size is large enough for AC ampere rating of charger as specified below:

Cord Length (Feet)	25'	50'	100'
Cord Size (AWG)	16	16	16

**NOTE:** AWG = American Wire Gauge

- **Do not operate charger with a damaged cord or plug**, which could cause shorting and electric shock. If damaged, have the charger replaced by an authorized serviceman.
- **Do not operate charger if it has received a sharp blow, been dropped, or otherwise damaged in any way.** Take it to an authorized serviceman for electrical check to determine if the charger is in good working order.
- **Do not disassemble charger.** Take it to an authorized serviceman when service or repair is required. Incorrect reassembly may result in a risk of electric shock or fire.
- **Unplug charger from outlet before attempting any maintenance or cleaning to reduce the risk of electric shock.**
- **Disconnect charger from the power supply when not in use.** This will reduce the risk of electric shock or damage to the charger if metal items should fall into the opening. It also will help prevent damage to the charger during a power surge.
- **Risk of electric shock.** Do not touch uninsulated portion of output connector or uninsulated battery terminal.
- **Save these instructions.** Refer to them frequently and use them to instruct others who may use this tool. If you loan someone this tool, loan them these instructions also to prevent misuse of the product and possible injury.

## IMPORTANT SAFETY INSTRUCTIONS

### 1. SAVE THESE INSTRUCTIONS











This manual contains important safety and operating instructions for battery chargers **(24V)** 140315001 (R85009) and **(18V)** 140276003 or 140276004.

2. **Before using battery charger**, read all instructions and cautionary markings on battery charger, battery, and product using battery.
3. **CAUTION:** To reduce the risk of injury, charge only RIDGID lithium-ion batteries on the RIDGID lithium-ion charger and RIDGID nickel-cadmium batteries on RIDGID nickel-cadmium chargers. These batteries and chargers are not interchangeable. Other types of batteries may burst, causing personal injury or damage.



# SYMBOLS



Some of the following symbols may be used on this tool. Please study them and learn their meaning. Proper interpretation of these symbols will allow you to operate the tool better and safer.

SYMBOL	NAME	DESIGNATION/EXPLANATION
V	Volts	Voltage
A	Amperes	Current
Hz	Hertz	Frequency (cycles per second)
W	Watt	Power
min	Minutes	Time
~	Alternating Current	Type of current
==	Direct Current	Type or a characteristic of current
$n_0$	No Load Speed	Rotational speed, at no load
	Class II Tool	Double-insulated construction
.../min	Per Minute	Revolutions, strokes, surface speed, orbits etc., per minute
	Wet Conditions Alert	Do not expose to rain or use in damp locations.
	Read The Operator's Manual	To reduce the risk of injury, user must read and understand operator's manual before using this product.
	Eye Protection	Always wear safety goggles or safety glasses with side shields and, as necessary, a full face shield when operating this product.
	Safety Alert	Precautions that involve your safety.
	No Hands Symbol	Failure to keep your hands away from the blade will result in serious personal injury.
	No Hands Symbol	Failure to keep your hands away from the blade will result in serious personal injury.
	No Hands Symbol	Failure to keep your hands away from the blade will result in serious personal injury.
	No Hands Symbol	Failure to keep your hands away from the blade will result in serious personal injury.
	Hot Surface	To reduce the risk of injury or damage, avoid contact with any hot surface.

# SYMBOLS

---

The following signal words and meanings are intended to explain the levels of risk associated with this product.

SYMBOL	SIGNAL	MEANING
	<b>DANGER:</b>	Indicates an imminently hazardous situation, which, if not avoided, will result in death or serious injury.
	<b>WARNING:</b>	Indicates a potentially hazardous situation, which, if not avoided, could result in death or serious injury.
	<b>CAUTION:</b>	Indicates a potentially hazardous situation, which, if not avoided, may result in minor or moderate injury.
	<b>CAUTION:</b>	(Without Safety Alert Symbol) Indicates a situation that may result in property damage.

## SERVICE

Servicing requires extreme care and knowledge and should be performed only by a qualified service technician. For service we suggest you return the product to your nearest **AUTHORIZED SERVICE CENTER** for repair. When servicing, use only identical replacement parts.



## WARNING:

To avoid serious personal injury, do not attempt to use this product until you read thoroughly and understand completely the operator's manual. If you do not understand the warnings and instructions in the operator's manual, do not use this product. Call RIDGID customer service for assistance.

---



## WARNING:



The operation of any power tool can result in foreign objects being thrown into your eyes, which can result in severe eye damage. Before beginning power tool operation, always wear safety goggles or safety glasses with side shields and, when needed, a full face shield. We recommend Wide Vision Safety Mask for use over eyeglasses or standard safety glasses with side shields. Always use eye protection which is marked to comply with ANSI Z87.1.

---

## SAVE THESE INSTRUCTIONS

# FEATURES

## PRODUCT SPECIFICATIONS

Coupler..... 1/4 in. Hex  
Switch..... Variable Speed Reversible (VSR)  
No Load Speed  
18V Nickel-Cadmium Battery Pack....0-1,700 r/min. (RPM)  
24V Lithium-Ion Battery Pack.....0-2,100 r/min. (RPM)

Blows Per Minute  
18V Nickel-Cadmium Battery Pack....0-2,900 r/min. (BPM)  
24V Lithium-Ion Battery Pack.....0-3,300 r/min. (BPM)  
Torque ..... 1,490 in.lb.  
Charger Input ..... 120V, 60 Hz, AC only

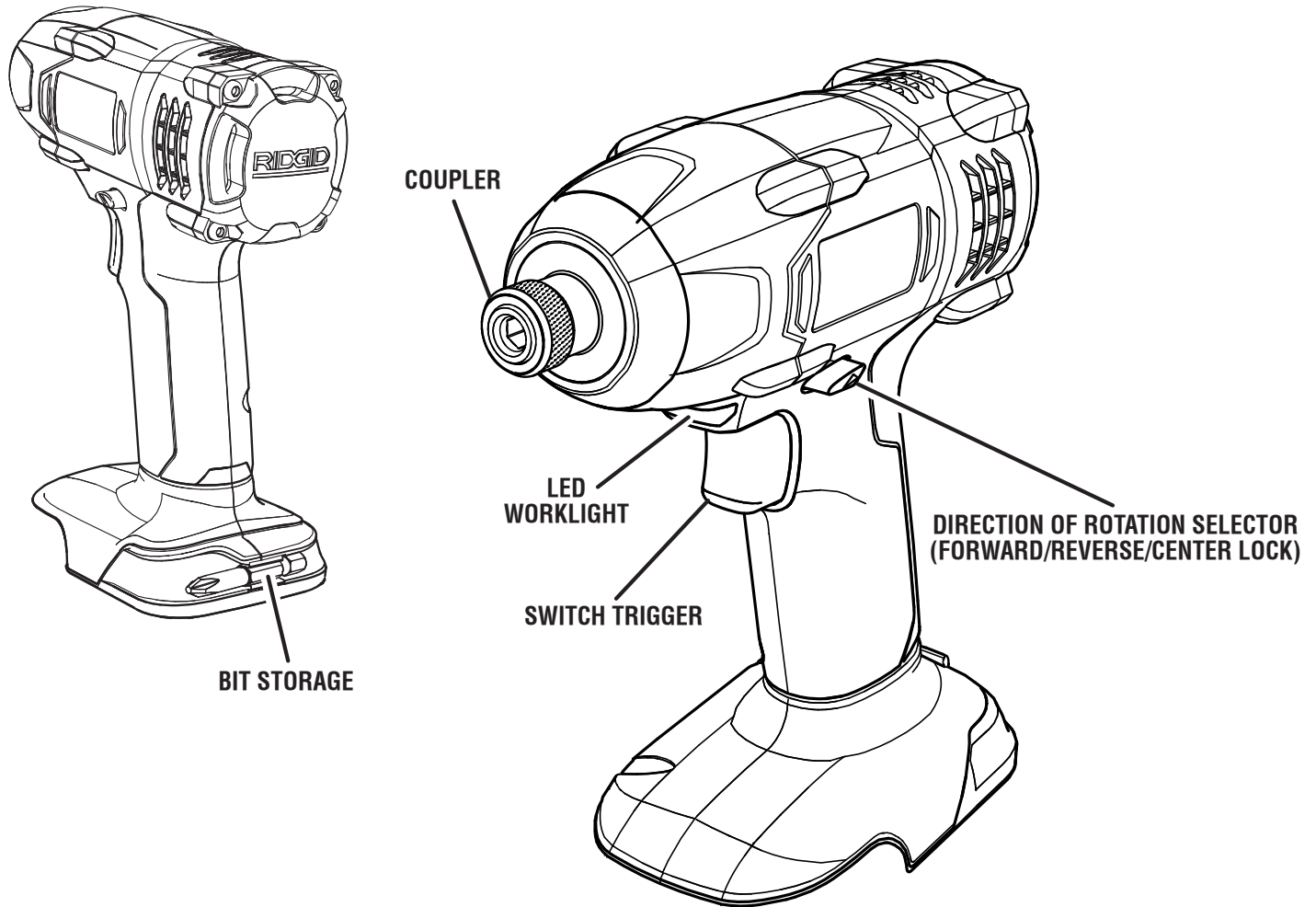

Fig. 1



# FEATURES

---

## KNOW YOUR IMPACT DRIVER

See Figure 1.

The safe use of this product requires an understanding of the information on the tool and in this operator's manual as well as a knowledge of the project you are attempting. Before use of this product, familiarize yourself with all operating features and safety rules.

### BIT STORAGE

Bits provided with the impact driver can be placed in the storage area, located on the base of the tool.

### BLOWS PER MINUTE

This tool features an impact speed of up to 3,300 BPM (Blows Per Minute). Blows Per Minute is the number of impacts per minute.

### COMPACT DESIGN

The compact design of the impact driver allows the operator to get into tight areas.

### COUPLER

Quickly and easily change bits without the need for tools.

## DIRECTION OF ROTATION SELECTOR (FORWARD/REVERSE/CENTER LOCK)

The impact driver has a direction of rotation (forward/reverse/center lock) selector located above the switch trigger for changing the direction of bit rotation. Setting the switch trigger in the **OFF** (center lock) position helps reduce the possibility of accidental starting when not in use.

### ELECTRIC BRAKE

The electric brake will stop the bit rotation after the operator releases the switch trigger.

### LED WORKLIGHT

The LED worklight, located below the coupler, illuminates when the switch trigger is depressed. This provides extra light for increased visibility.

### MINIMUM REACTIVE TORQUE

This impact driver minimizes the amount of reactive torque to the operator.

### VARIABLE SPEED

The variable speed switch trigger delivers higher speed with increased trigger pressure and lower speed with decreased trigger pressure.

# ASSEMBLY

---

## UNPACKING

This product has been shipped completely assembled.

- Carefully remove the tool and any accessories from the box. Make sure that all items listed in the packing list are included.
- Inspect the tool carefully to make sure no breakage or damage occurred during shipping.
- Do not discard the packing material until you have carefully inspected and satisfactorily operated the tool.
- If any parts are damaged or missing, please call 1-866-539-1710 for assistance.

## PACKING LIST

Impact Driver

Bit

Operator's Manual

---

### WARNING:

If any parts are damaged or missing do not operate this tool until the parts are replaced. Failure to heed this warning could result in serious personal injury.

---

---

### WARNING:

Do not attempt to modify this tool or create accessories not recommended for use with this tool. Any such alteration or modification is misuse and could result in a hazardous condition leading to possible serious personal injury.

---

---

### WARNING:

To prevent accidental starting that could cause serious personal injury, always remove the battery pack from the tool when assembling parts.

---

# OPERATION

## **WARNING:**

Do not allow familiarity with tools to make you careless. Remember that a careless fraction of a second is sufficient to inflict severe injury.

## **WARNING:**

Always wear safety goggles or safety glasses with side shields when operating tools. Failure to do so could result in objects being thrown into your eyes resulting in possible serious injury.

## **WARNING:**

Do not use any attachments or accessories not recommended by the manufacturer of this tool. The use of attachments or accessories not recommended can result in serious personal injury.

## APPLICATIONS

You may use this tool for the following purposes:

- Driving screws and lag bolts
- Tightening nuts and bolts
- Removing screws, nuts, and bolts

## CAUTION:

If at any point during the charging process none of the LEDs are lit, remove the battery pack from the charger to avoid damaging the product. DO NOT insert another battery. Return the charger and battery to your nearest service center for service or replacement.

## CAUTION:

Charge in a well ventilated area. Do not block charger vents. Keep them clear to allow proper ventilation.

**NOTE:** Charge only RIDGID lithium-ion batteries on the RIDGID lithium-ion charger and RIDGID nickel-cadmium batteries on RIDGID nickel-cadmium chargers. These batteries and chargers are not interchangeable.

Refer to the *General Safety Rules* for compatibility.

**THE FOLLOWING INSTRUCTIONS ARE FOR RIDGID 24V LITHIUM-ION BATTERY PACKS AND THE 24V RIDGID LITHIUM-ION CHARGER.**

## CHARGING THE BATTERY PACK

**NOTE:** New 24V lithium-ion battery packs will not work without first being charged. Before first time use, charge the battery pack to activate it.

It is not necessary to drain the battery pack completely before recharging. Lithium-ion battery packs have no “memory” and can be recharged at any time. It is therefore possible to charge the battery pack before extended usage even if the battery pack is not completely drained of charge. Use the charge level indicator to determine the amount of charge in the battery pack.

Lithium-ion batteries deliver fade free power for their entire run time. 24V lithium-ion tools will not gradually lose power due to decreasing battery charge. Instead, power from the battery pack will drop from full to zero once the full charge has been drained from the battery. Once this happens, the tool’s power drops from full to zero, and recharging of the battery is required

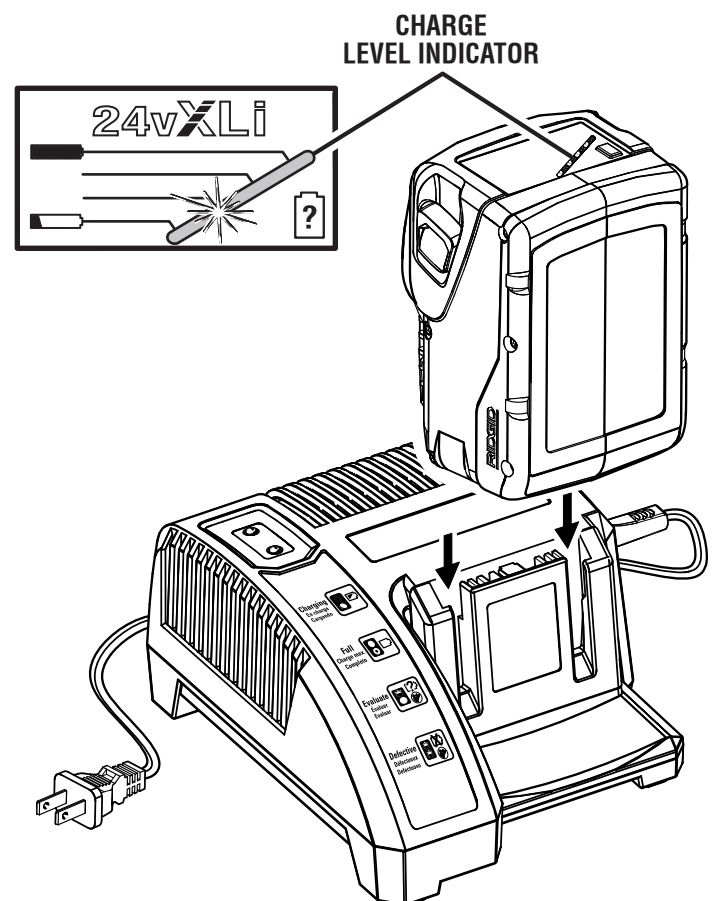

Fig. 2

# OPERATION

## TO CHARGE

A fully discharged battery pack with a temperature between 32°F and 150°F will charge in about an hour.

- Charge the 24V lithium-ion battery pack only with the charger provided.
- Connect the charger to a power supply.  
**NOTE:** If needed, the charger can operate with most generators and inverters rated at 300 Watts or higher.
- Attach the battery pack to the charger by aligning the raised ribs on the battery pack with the grooves in the charger, then slide the battery pack onto the charger. See Figure 2.
- Do not place the charger in an area of extreme heat or cold. It will work best at normal room temperature.
- After charging is complete, the continuous green light will come on and the charge level indicator lights on the battery will go off.
- The charger will keep the battery pack fully charged if left on the charger.

## CHARGE LEVEL INDICATOR

See Figure 3.

The charge level indicator shows that the battery is charged at 1/4, 1/2, 3/4, or full capacity. To display the amount of charge left in the battery, press and hold the charge level indicator button.

**NOTE:** When the battery pack contains less than 10% charge, the 1/4 charge level indicator will flash.

## CHARGING A HOT BATTERY PACK

If the battery pack is above normal temperature range, the red LED will begin flashing and the green LED will be off. When the battery pack cools down to approximately 150°F, the charger will automatically begin fast charge mode.

**NOTE:** Refer to **CHARGING THE BATTERY PACK** for normal recharging of batteries. If the charger does not charge the battery pack under normal circumstances, return both the battery pack and charger to your nearest repair center for electrical check. For the location of your nearest repair center, please call 1-866-539-1710.

## CHARGING A COOL BATTERY PACK

If the battery pack is below normal temperature range, the red LED will begin flashing and the green LED will be off. When the battery warms to a temperature of more than 14°F, the charger will automatically begin charge mode.

## COLD WEATHER OPERATION

The lithium-ion battery pack can be used in temperatures down to -4°F. When the battery pack is very cold, it may “buzz” for the first minute of use to warm itself up. Put the battery pack on a tool and use the tool in a light duty application. After about a minute, the pack will have warmed up and begin operating normally.

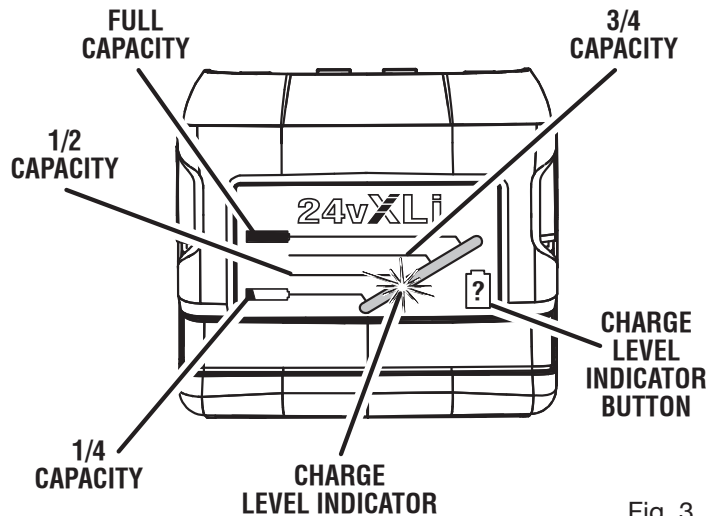

Fig. 3

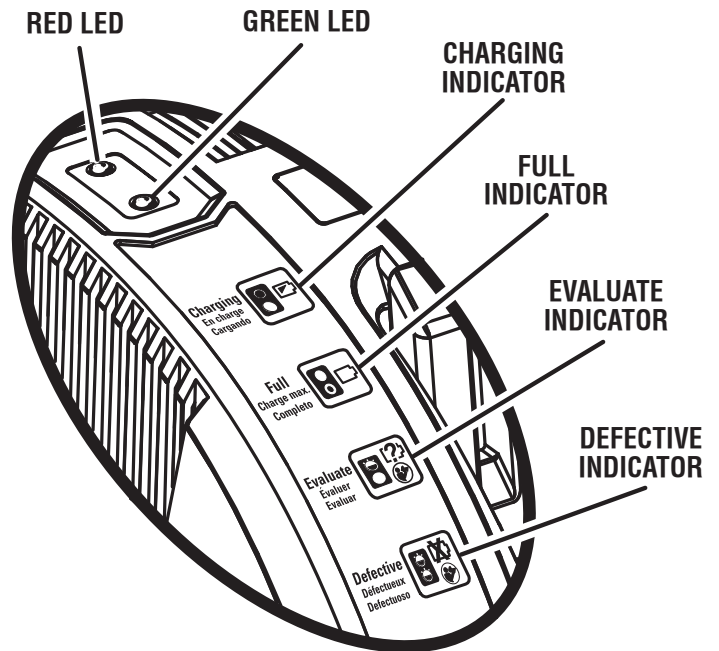





Fig. 4

# OPERATION

## LED FUNCTION OF RIDGID 24V LITHIUM-ION CHARGER

See Figure 4.

LED INDICATOR		BATTERY PACK	RED LED	GREEN LED	ACTION
<b>Charging</b> En charge Cargando 	Charging	Fast charging	ON	OFF	Charges in 1 hour.
	Charging	Deeply Discharged	ON	OFF	Charger pre-charges battery until normal voltage is reached, then begins fast charge mode. May take longer than 1 hour to fully charge.
<b>Full</b> Charge max. Completo 	Full	Maintenance charging	OFF	ON	Fast charging is complete; Charger maintains charge mode.
<b>Evaluate</b> Évaluer Evaluar 	Evaluate	Hot battery pack	Flashing	OFF	When battery pack reaches cooled temperature, charger begins fast charge mode.
	Evaluate	Cold battery pack	Flashing	OFF	When battery pack reaches warmed temperature, charger begins fast charge mode.
<b>Defective</b> Défectueux Defectuoso 	Defective	Defective	Flashing	Flashing	Battery pack or charger is defective.
	<ul style="list-style-type: none"> <li>• If defective, try to repeat the conditions a second time by removing and reinstalling the battery pack. If the LED status repeats a second time, try charging a different battery.</li> <li>• If a different battery charges normally, dispose of the defective pack (see <i>Maintenance</i> section).</li> <li>• If a different battery also indicates “Defective,” the charger may be defective.</li> </ul>				

# OPERATION

## THE FOLLOWING INSTRUCTIONS ARE FOR RIDGID NICKEL-CADMIUM BATTERY PACKS AND CHARGERS.

Battery packs for this tool are shipped in a low charge condition to prevent possible problems. Therefore, you should charge the pack until the light on the front of the charger changes from flashing green to continuous green.

**NOTE:** Batteries will not reach full charge the first time they are charged. Allow several cycles (operation followed by recharging) for them to become fully charged. This is normal for nickel-cadmium batteries.

### TO CHARGE

- Charge the battery pack only with the charger provided.
- Make sure the power supply is normal household voltage, **120V, 60 Hz, AC only.**
- Connect the charger to a power supply.
- Attach the battery pack to the charger by aligning the raised ribs on the battery pack with the grooves in the charger, then slide the battery pack onto the charger. *See Figure 5.*
- The battery pack will become slightly warm to the touch while charging. This is normal and does not indicate a problem.
- Do not place the charger in an area of extreme heat or cold. It will work best at normal room temperature.
- For average charge times, refer to the chart on the following page.
- When the batteries become fully charged, unplug the charger from the power supply and remove the battery pack.

### CHARGING A HOT BATTERY PACK

When using the tool continuously, the batteries in the battery pack will become hot. You should let a hot battery pack cool down for approximately 30 minutes before attempting to recharge. When the battery pack becomes discharged and is hot, the green LED will be off and the red LED will begin flashing.

When the battery pack cools down to approximately 104°F, the charger will automatically begin fast charge mode.

### CHARGING A COOL BATTERY PACK

If the battery pack is below normal temperature range, the red LED will begin flashing and the green LED will be off. When the battery warms to a temperature of more than 41°F, the charger will automatically begin fast charge mode.

**NOTE:** Refer to **CHARGING THE BATTERY PACK** for normal recharging of batteries. If the charger does not charge your battery pack under normal circumstances, return both the battery pack and charger to your nearest repair center for electrical check. For the location of your nearest repair center, please call 1-866-539-1710.

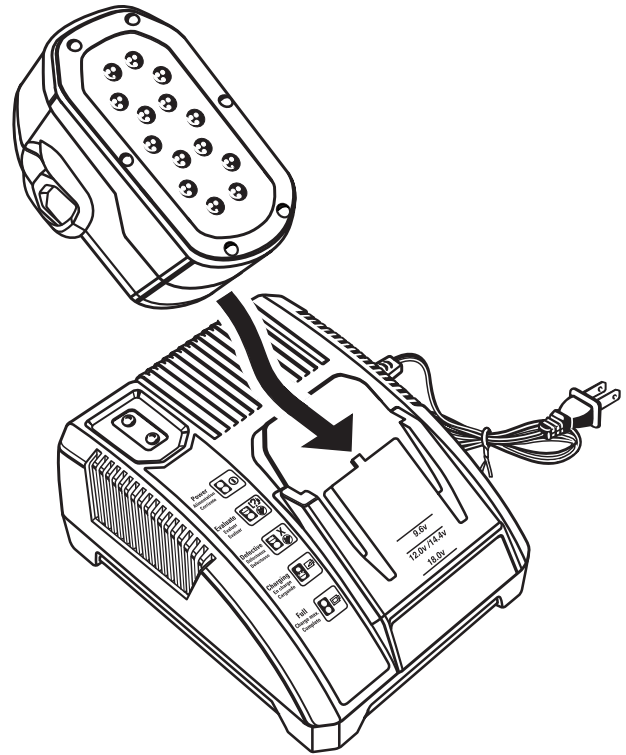

Fig. 5

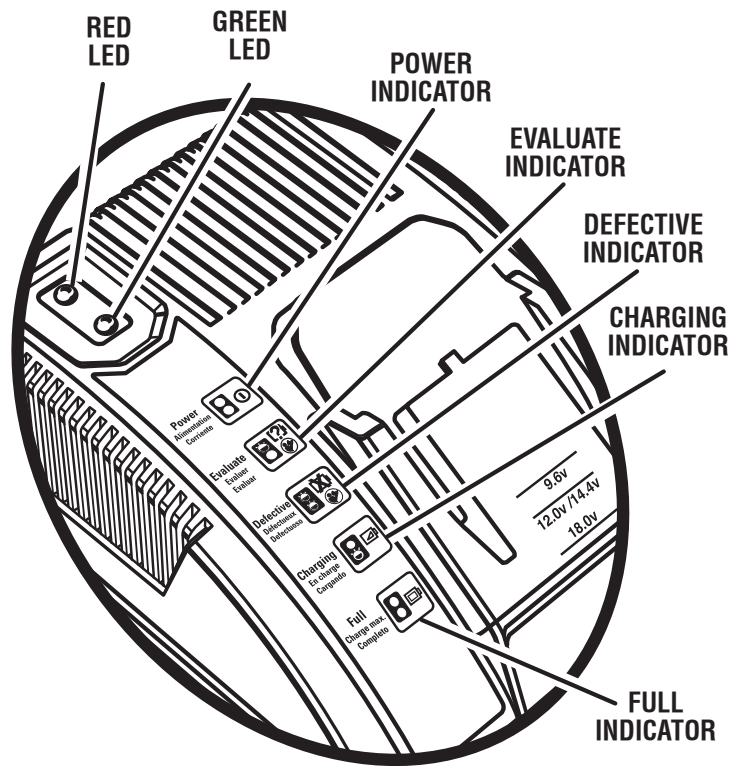







Fig. 6

# OPERATION

## LED FUNCTION OF RIDGID NICKEL-CADMIUM CHARGERS

See Figure 6.

LED INDICATOR		BATTERY PACK	RED LED	GREEN LED	ACTION	
<b>Power</b> Alimentation Corriente		Without battery pack	ON	OFF	Ready to charge battery pack.	
<b>Evaluate</b> Evaluer Evaluar		Evaluate	Hot battery pack	Flashing	OFF	When battery pack reaches cooled temperature, charger begins fast charge mode.
		Evaluate	Cold battery pack	Flashing	OFF	When battery pack reaches warmed temperature, charger begins fast charge mode.
		Evaluate	Deeply discharged	Flashing	OFF	Charger pre-charges battery until normal voltage is reached, then begins fast charge mode.
<b>Defective</b> Défectueux Defectuoso		Defective	Defective	Flashing	Flashing	Battery pack or charger is defective.
		<ul style="list-style-type: none"> <li>• If defective, try to repeat the conditions a second time by removing and reinstalling the battery pack. If the LED status repeats a second time, try charging a different battery.</li> <li>• If a different battery charges normally, dispose of the defective pack (see <i>Maintenance</i> section).</li> <li>• If a different battery also indicates “Defective,” the charger may be defective.</li> </ul>				
<b>Charging</b> En charge Cargando		Charging	Fast charging	ON	Flashing	See chart below for charge times.
<b>Full</b> Charge max. Completo		Full	Slow charging	OFF	ON	Fast charging is complete; charger maintains charge mode.

BATTERY	AVERAGE CHARGE TIME
COMPACT SERIES	18 min.
HC	27 min.
HC 2.5	34 min.



# OPERATION

## TO INSTALL BATTERY PACK

See Figure 7.

- Place the battery pack in the impact driver, aligning raised rib on battery pack with groove in the driver's battery port.
- Make sure the latches on each side of the battery pack snap into place and the battery pack is secured to the impact driver before beginning operation.

## TO REMOVE BATTERY PACK

See Figure 8.

- Locate the latches on the side of the battery pack and depress both sides to release the battery pack from the impact driver.
- Remove the battery pack.

### **WARNING:**

Battery tools are always in operating condition. Therefore, switch should always be locked when not in use or carrying at your side.

## SWITCH TRIGGER

See Figure 9.

To turn the impact driver **ON**, depress the switch trigger. To turn it **OFF**, release the switch trigger.

## VARIABLE SPEED

See Figure 9.

This tool has a variable speed switch that delivers higher speed and torque with increased trigger pressure. Speed is controlled by the amount of switch trigger depression.

**NOTE:** You might hear a whistling or ringing noise from the switch during use. Do not be concerned; this is a normal part of the switch function.

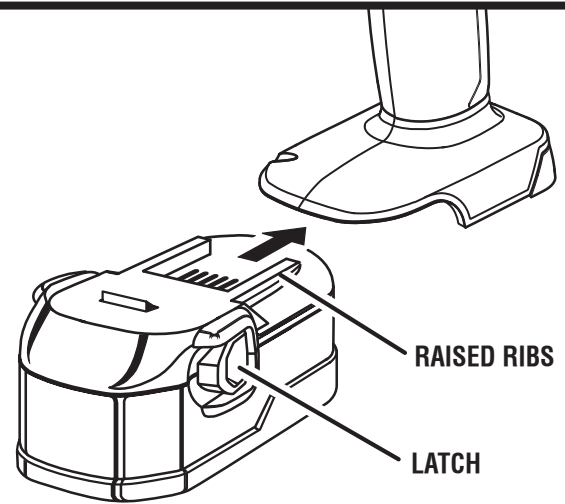
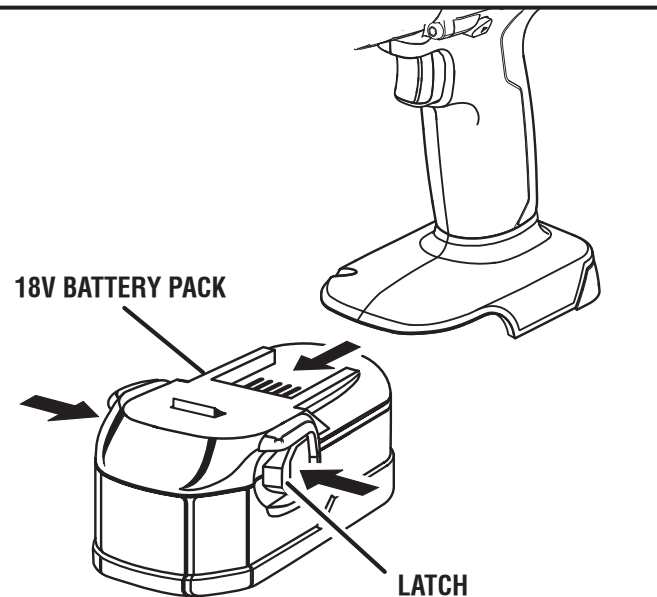

Fig. 7



**DEPRESS LATCHES TO  
RELEASE BATTERY PACK**

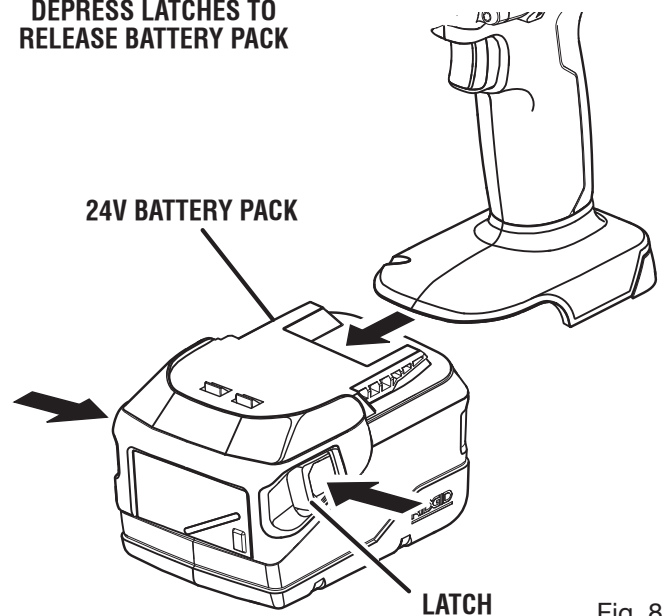

Fig. 8

# OPERATION

## DIRECTION OF ROTATION SELECTOR

See Figure 9.

The direction of bit rotation is reversible and is controlled by a selector located above the switch trigger. With the impact driver held in normal operating position, the direction of rotation selector should be positioned to the left of the switch trigger for driving. The driving direction is reversed when the selector is to the right of the switch trigger.

Setting the switch trigger in the **OFF** (center lock) position helps reduce the possibility of accidental starting when not in use.

### CAUTION:

To prevent gear damage, always allow the coupler to come to a complete stop before changing the direction of rotation.

To stop the impact driver, release the switch trigger and allow the coupler to come to a complete stop.

**NOTE:** The impact driver will not run unless the direction of rotation selector is pushed fully to the left or right.

Avoid running the driver at low speeds for extended periods of time. Running at low speeds under constant usage may cause the driver to become overheated. If this occurs, cool the driver by running it without a load and at full speed.

## LED WORKLIGHT

See Figure 9.

The LED worklight, located below the coupler, illuminates when the switch trigger is depressed. This provides additional lighting on the surface of the workpiece for operation in lower-light areas.

## INSTALLING BITS

See Figure 10.

- Lock the switch trigger by placing the direction of rotation selector in the center position.
- Remove the battery pack from the impact driver.
- Pull the coupler away from the driver (1).
- Insert driver bit to be used into the coupler (2).
- Release the coupler (3).
- Pull on the bit to make sure it is secured in the coupler. There may be some play in the installed bit; this is normal.

**NOTE:** Use only impact quality bits with a locking groove.

### ⚠ WARNING:

Make sure the bit is secured in the coupler before using the impact driver. Failure to do so could cause serious personal injury.

## DIRECTION OF ROTATION SELECTOR (FORWARD/REVERSE/CENTER LOCK)

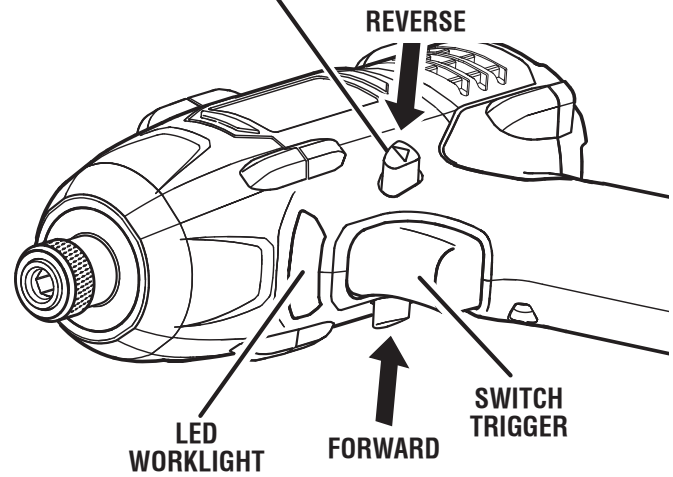

Fig. 9

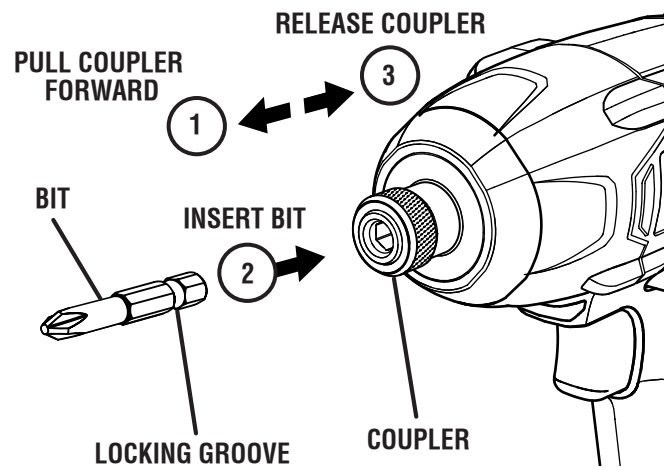

Fig. 10

# OPERATION

## REMOVING BITS

See Figure 10.

- Lock the switch trigger by placing the direction of rotation selector in the center position.
- Remove the battery pack from the impact driver.
- Pull the coupler away from the driver.
- Remove driver bit from the coupler.

### **⚠ WARNING:**

Do not drive a screw where there is likely to be hidden wiring behind the surface. Contact with a “live” wire will make exposed metal parts of the tool “live” and shock the operator. If you must drive a screw where hidden wire may be present, always hold tool by insulated gripping surfaces (handle) when performing the operation to prevent a shock to the operator, as seen in figure 11.

### **CAUTION:**

The impact driver is not designed to be used as a drill.

## DRIVING OR REMOVING SCREWS

See Figures 11 - 12.

- Place the direction of rotation selector in the correct position for the operation.
- Hold the impact driver with one hand.
- Place the bit on the screw head and slowly depress the switch trigger. Start the bit slowly for more control.
- As screw is driven, impacting will begin.

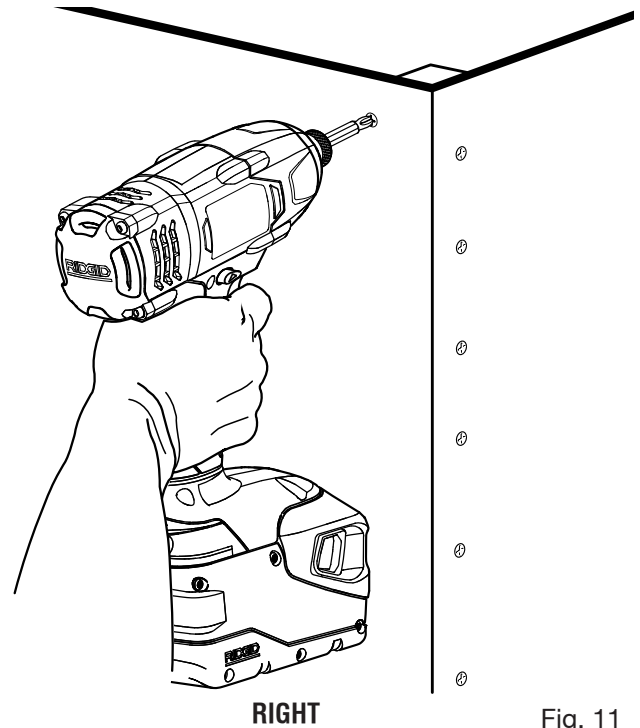

Fig. 11

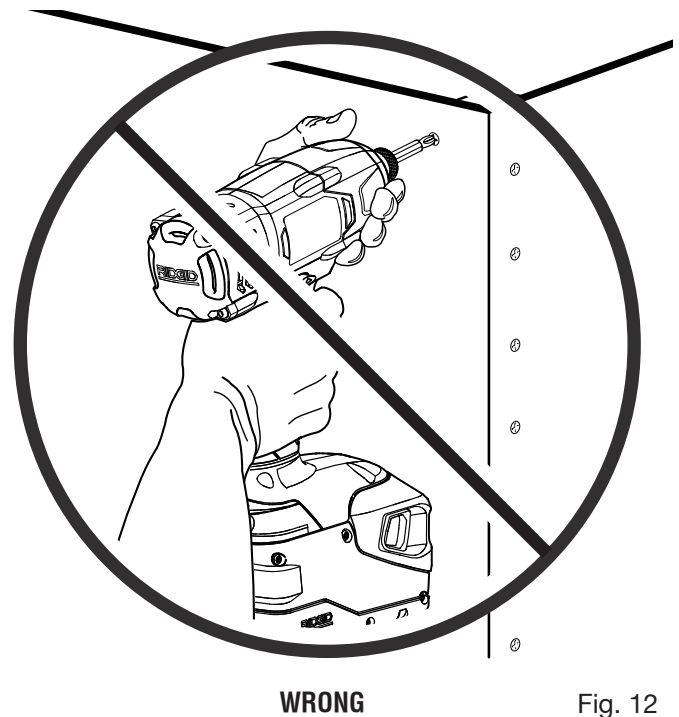

Fig. 12

# MAINTENANCE

---

## **WARNING:**

When servicing use only identical RIDGID replacement parts. Use of any other parts may create a hazard or cause product damage.

---

## **WARNING:**

Always wear safety goggles or safety glasses with side shields during power tool operation or when blowing dust. If operation is dusty, also wear a dust mask.

---

## **WARNING:**

To avoid serious personal injury, always remove the battery pack from the tool when cleaning or performing any maintenance.

---

## BATTERIES

This tool will accept 24V lithium-ion batteries or 18V nickel-cadmium batteries. Length of service from each charging will depend on the type of work you are doing.

The batteries for this tool have been designed to provide maximum trouble-free life. However, like all batteries, they will eventually wear out. Do not disassemble battery pack and attempt to replace the batteries. Handling of these batteries, especially when wearing rings and jewelry, could result in a serious burn.

To obtain the longest possible battery life, we suggest the following:

### For lithium-ion batteries:

- Remove the battery pack from the charger once it is fully charged and ready for use.

For battery pack storage longer than 30 days:

- Store the battery pack where the temperature is below 80°F and away from moisture.
- Store battery packs in a 30%-50% charged condition.
- Every six months of storage, charge the pack as normal.

### For nickel-cadmium batteries:

- Remove the battery pack from the charger once it is fully charged and ready for use.

For battery pack storage longer than 30 days:

- Store the battery pack where the temperature is below 80°F.
- Store battery packs in a “discharged” condition.

## GENERAL MAINTENANCE

Avoid using solvents when cleaning plastic parts. Most plastics are susceptible to damage from various types of commercial solvents and may be damaged by their use. Use clean cloths to remove dirt, dust, oil, grease, etc.

---

## **WARNING:**

Do not at any time let brake fluids, gasoline, petroleum-based products, penetrating oils, etc., come in contact with plastic parts. Chemicals can damage, weaken or destroy plastic which may result in serious personal injury.

---

Only the parts shown on the parts list are intended to be repaired or replaced by the customer. All other parts should be replaced at a RIDGID authorized service center.

---

## BATTERY PACK REMOVAL AND PREPARATION FOR RECYCLING



To preserve natural resources, please recycle or dispose of batteries properly.

This product uses lithium-ion or nickel-cadmium batteries. Local, state or federal laws may prohibit disposal of batteries in ordinary trash.



Consult your local waste authority for information regarding available recycling and/or disposal options.

---

## **WARNING:**

Upon removal, cover the battery pack's terminals with heavy-duty adhesive tape. Do not attempt to destroy or disassemble battery pack or remove any of its components. Lithium-ion and nickel-cadmium batteries must be recycled or disposed of properly. Also, never touch both terminals with metal objects and/or body parts as short circuit may result. Keep away from children. Failure to comply with these warnings could result in fire and/or serious injury.

---

# WARRANTY

---

## RIDGID® HAND HELD AND STATIONARY POWER TOOL 3 YEAR LIMITED SERVICE WARRANTY

Proof of purchase must be presented when requesting warranty service.

Limited to RIDGID® hand held and stationary power tools purchased 2/1/04 and after. This product is manufactured by One World Technologies, Inc. The trademark is licensed from RIDGID, Inc. All warranty communications should be directed to One World Technologies, Inc., attn: RIDGID Hand Held and Stationary Power Tool Technical Service at (toll free) 1-866-539-1710.

### 90-DAY SATISFACTION GUARANTEE POLICY

During the first 90 days after the date of purchase, if you are dissatisfied with the performance of this RIDGID® Hand Held and Stationary Power Tool for any reason you may return the tool to the dealer from which it was purchased for a full refund or exchange. To receive a replacement tool you must present proof of purchase and return all original equipment packaged with the original product. The replacement tool will be covered by the limited warranty for the balance of the 3 YEAR service warranty period.

### WHAT IS COVERED UNDER THE 3 YEAR LIMITED SERVICE WARRANTY

This warranty on RIDGID® Hand Held and Stationary Power Tools covers all defects in workmanship or materials and normal wear items such as brushes, chucks, motors, switches, cords, gears and even cordless batteries in this RIDGID® tool for three years following the purchase date of the tool. Warranties for other RIDGID® products may vary.

### HOW TO OBTAIN SERVICE

To obtain service for this RIDGID® tool you must return it; freight prepaid, or take it in to an authorized service center for RIDGID® branded hand held and stationary power tools. You may obtain the location of the authorized service center nearest you by calling (toll free) 1-866-539-1710 or by logging on to the RIDGID® website at [www.ridgid.com](http://www.ridgid.com). When requesting warranty service, you must present the original dated sales receipt. The authorized service center will repair any faulty workmanship, and either repair or replace any part covered under the warranty, at our option, at no charge to you.

### WHAT IS NOT COVERED

This warranty applies only to the original purchaser at retail and may not be transferred. This warranty only covers defects arising under normal usage and does not cover any malfunction, failure or defect resulting from misuse, abuse, neglect, alteration, modification or repair by other than an authorized service center for RIDGID® branded hand held and stationary power tools. Consumable accessories provided with the tool such as, but not limited to, blades, bits and sand paper are not covered.

**RIDGID, INC. AND ONE WORLD TECHNOLOGIES, INC. MAKE NO WARRANTIES, REPRESENTATIONS OR PROMISES AS TO THE QUALITY OR PERFORMANCE OF ITS POWER TOOLS OTHER THAN THOSE SPECIFICALLY STATED IN THIS WARRANTY.**

### ADDITIONAL LIMITATIONS

To the extent permitted by applicable law, all implied warranties, including warranties of MERCHANTABILITY or FITNESS FOR A PARTICULAR PURPOSE, are disclaimed. Any implied warranties, including warranties of merchantability or fitness for a particular purpose, that cannot be disclaimed under state law are limited to three years from the date of purchase. One World Technologies, Inc. and RIDGID, Inc. are not responsible for direct, indirect, incidental or consequential damages. Some states do not allow limitations on how long an implied warranty lasts and/or do not allow the exclusion or limitation of incidental or consequential damages, so the above limitations may not apply to you. This warranty gives you specific legal rights, and you may also have other rights which vary from state to state.

---

**One World Technologies, Inc.**

P.O. Box 35, Hwy. 8  
Pickens, SC 29671

---

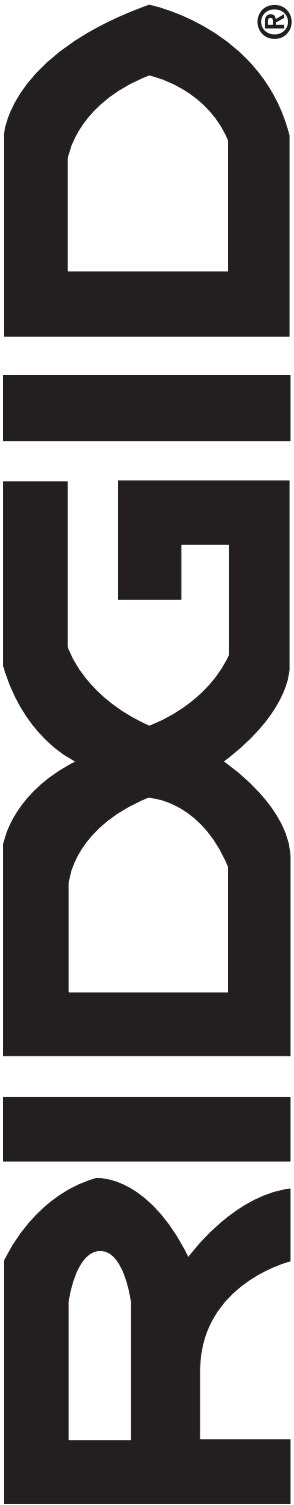

# OPERATOR'S MANUAL

**18V/24V MaxSelect™**  
**1/4 in. IMPACT DRIVER**  
**R8823**

## **Customer Service Information:**

For parts or service, contact your nearest RIDGID authorized service center. Be sure to provide all relevant information when you call or visit. For the location of the authorized service center nearest you, please call 1-866-539-1710 or visit us online at [www.ridgid.com](http://www.ridgid.com).

The model number of this tool is found on a plate attached to the motor housing. Please record the serial number in the space provided below. When ordering repair parts, always give the following information:

**Model No.** \_\_\_\_\_ R8823 \_\_\_\_\_

**Serial No.** \_\_\_\_\_