

Coffee Machine SKAT 1000 A1

60

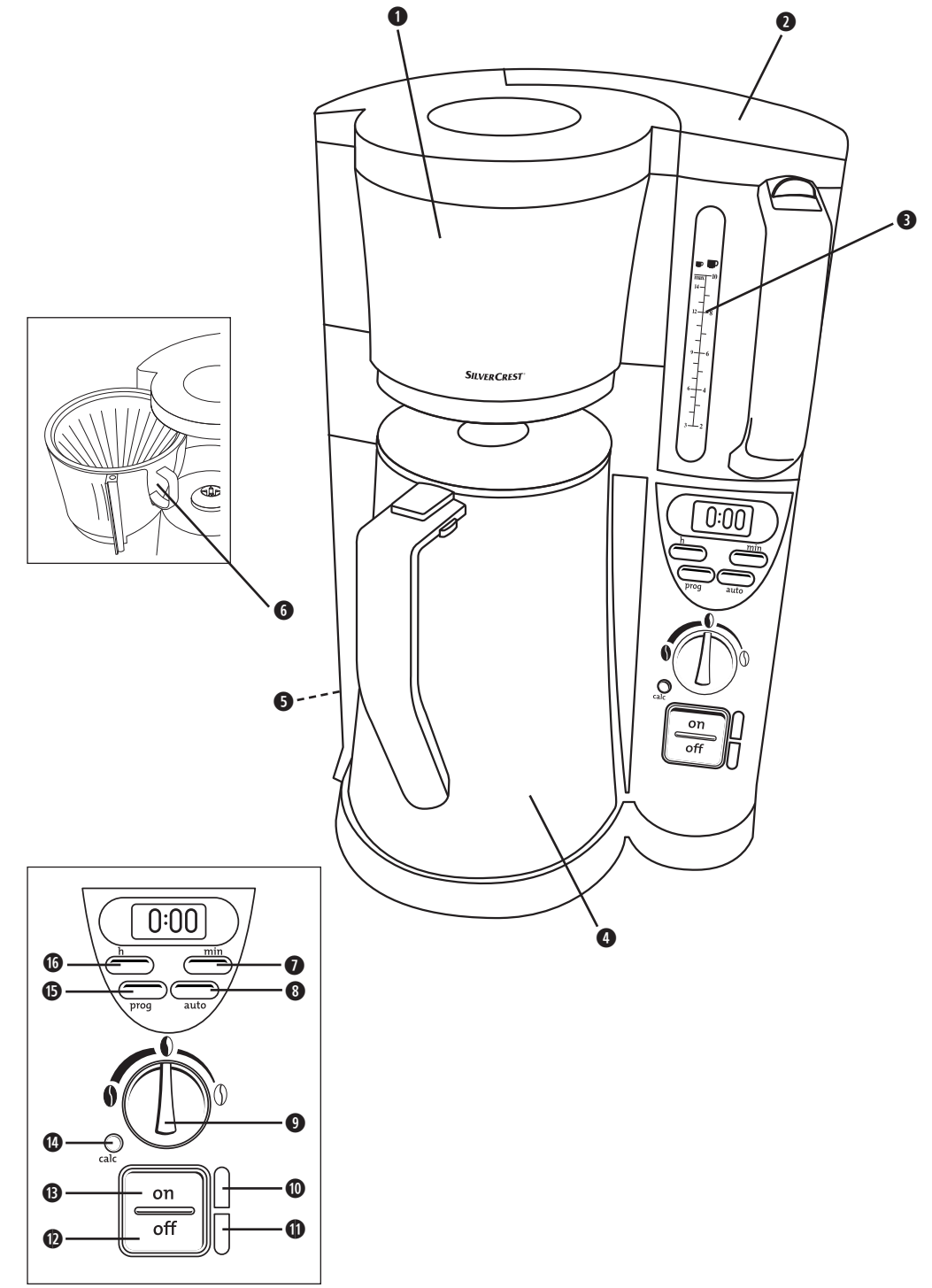

GB **Coffee Machine**
IE Operating instructions

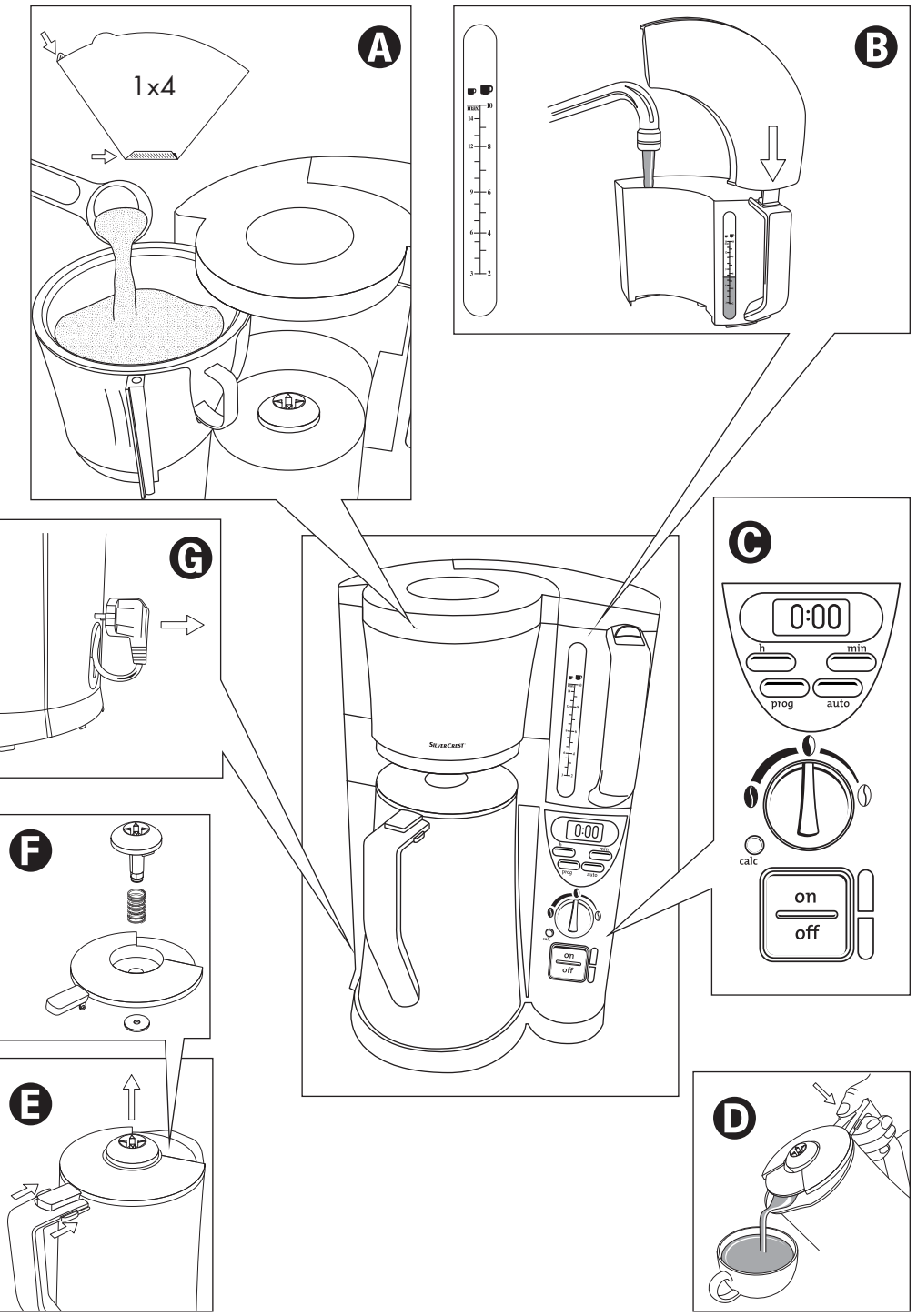

CONTENT	PAGE
Safety instructions	2
Technical data	3
Items supplied	3
Intended use	3
Description of parts	3
Before the First Use	3
Setting the time	4
Memory Function.....	4
Making coffee	4
Using the Timer.....	4
Cleaning and care	5
Cleaning of the lid.....	5
Removing scale	5
Rectifying malfunctions	6
The Coffee Maker does not start working.....	6
The brewing process does not start at the determined time (Timer Function):.....	6
The coffee is too strong/too weak:	6
The brewing process lasts very long.	6
The appliance switches off during brewing.....	6
The unit gets very loud during brewing.	6
Immoderate steam develops during brewing.	6
Disposal	6
Warranty & Service	7
Importer	7

Read these operating instructions carefully before using the appliance for the first time and preserve this manual for later reference. Pass this manual on to whoever might acquire the appliance at a future date.

Coffee Machine

Safety instructions



Danger of electric shock!

- Connect the appliance only to correctly installed and earthed mains sockets.
- Remove the plug from the wall socket when you move the appliance, fill it with water, if it malfunctions, before cleaning it and when it is not in use.
- NEVER submerge the appliance in liquids. Should liquids nonetheless permeate into the appliance housing, immediately remove the plug from the wall socket. Arrange for it to be repaired by qualified specialists.
- Never take hold of the appliance, power cable or plug with wet hands.
- To disconnect, always pull the plug itself from the power socket, do not pull on the power cable.
- Do not fold or squeeze the power cable.
- Should the power cable or plug be damaged, to avoid possibly life-threatening risks immediately arrange for it to be replaced by qualified specialists.



Fire hazard!

- Do not leave the appliance unattended when in use.
- Never operate the appliance without water.
- Never place the appliance near sources of heat.
- Do not use extension cables. In the event of danger, the plug must be quickly accessible.
- Do not operate the appliance via an external time-switch or a separate remote control system.

Risk of personal injuries

- NEVER use the thermos jug  in a microwave oven.
- This appliance is not intended for use by persons (including children) with reduced physical, sensory or mental capabilities, or lack of experience and knowledge, unless they have been given supervision or instruction concerning use of the appliance by a person responsible for their safety.
- Children should be supervised to ensure that they do not play with the appliance.
- Lay the power cable in such a way that no one can tread on or trip over it.
- Do not insert sharp or stiff objects into the thermos jug r. Do not grab into the thermos jug . This may damage the appliance and lead to injuries.

Risk of scalding!

- Never open the filter holder  during the brewing process.
- Do not handle the hot filter bag. Remove the filter bag first when the coffee has drained away and it has cooled down. Use the filter insert  to remove the filter bag.
- Do not hold your hands in the rising steam.
- Never move/transport the appliance during the brewing process.
- Remove the thermos jug  first when the brewing process is complete and the filter has fully drained itself.
- Always close the filter container before switching on, there exists a risk of scalds from steam and hot water.

Caution: To avoid damage to the appliance!

- Fill the water tank ② of the appliance exclusively with clean water.
- Do not expose the glass of the thermos jug ④ to extreme variation in temperature. The glass can be damaged.
- There is no liability for damages caused by breakage of glass!

Technical data

Mains voltage:	220 - 240 V ~ 50 Hz
Power consumption:	1000 W
Coffee filter bags:	Size 1x4

Items supplied

- Coffee Machine with Timer Function
- Thermos jug with lid
- Measuring spoon
- Operating instructions

Before taking the appliance into use, check that all items are present and free of visible damage.

Intended use

The Coffee Maker is intended exclusively for brewing coffee. This Coffee Maker is intended exclusively for use in private domestic households. Do not use it commercially. The appliance is for indoor use only.

Description of parts

The description of parts is located at the right fold out page.

Coffee Maker:

- ① Filter holder
- ② Water tank
- ③ Scale
- ④ Thermos jug
- ⑤ Cable storage compartment
- ⑥ Filter insert

Control panel:

- ⑦ Button "min"
- ⑧ Button "auto"
- ⑨ Aroma knob
- ⑩ Red indicator
- ⑪ Green indicator
- ⑫ Switch "off"
- ⑬ Switch "on"
- ⑭ Red indicator "calc"
- ⑮ Button "prog"
- ⑯ Button "h"

Before the First Use

ⓘ Note:

Never fill the appliance with water beyond the max-marking (10 cups). The appliance can overflow.

- Before the first use, set the aroma knob ⑨ to the ① setting and allow two times 8 cups of water to flow through the appliance. Do not use coffee powder for this.
- Clean the appliance (see chapter "Cleaning and care").

Setting the time

- Press the buttons "h" **16** for hours resp. "min" **7** for minutes repeatedly until the correct time is shown in the display.



Memory Function

In the event of a power failure lasting up to about 5 minutes, the setting of time and timer is saved once power has been restored.

Making coffee

Avoid brewing less than 2 large or 3 small cups of coffee. Otherwise, the coffee will not have the desired temperature and strength.

- Turn the filter holder **1** to the outside and insert a filter bag (Size 1x4) with its sides folded over into the filter insert **6**. Fill the bag with the required amount of coffee powder (medium to fine ground) (Fig. **A**). One small teaspoon is equivalent to about 6 g of coffee powder.

			g
3	2	3 x 6g	18
4 ¹ / ₂	3	4 x 6g	24
6	4	5 x 6g	30
7 ¹ / ₂	5	6 x 6g	36
9	6	7 x 6g	42
10 ¹ / ₂	7	7 ¹ / ₂ x 6g	45
12	8	8 ¹ / ₂ x 6g	51
13 ¹ / ₂	9	9 x 6g	54
15	10	10 x 6g	60

- Turn the filter holder **1** back into the Coffee Maker.
- Fill the required amount of water in the water tank **2** (Fig. **B**) by using the scale on the outside **3** (Fig. **B**) of the water tank. Never pour more water in than to the Max marking (10 cups), or less water than for 3 small or 2 large cups.
- Enter in the desired coffee strength by turning the aroma knob **9** on the Panel (Fig. **C**). The setting **1** results in stronger coffee and the setting **1** results in mild coffee.
- Place the thermos jug **4** in the Coffee maker and make sure the thermos jug **4** is empty before every use.

Note:

The coffee remains warm for a longer period if the thermos jug is rinsed out with hot water before use.

- Start the brewing process by pressing switch "on" **15**. The red indicator **10** turns on.
- Pour the coffee from the thermos jug **4** after the red indicator light **10** turns off.

Take note of Fig. **D** for serving the coffee.

Note:

Let the coffee maker cool down for about 5 minutes, before you start the next brewing process or add water.

Using the Timer

With the button „prog“ **15** you can programme the Coffee Maker so that it starts the brewing process at a predetermined time. Always first insert coffee powder into the filter bag in the filter holder **6** and water into the water tank **2**.

Place the thermos jug **4** in the Coffee Maker.

Make sure the thermos jug **4** is empty and the water tank **2** is not filled beyond the max-marking (10 cups) before every use.

- Press and hold down the button "prog" 15.
- Enter in the desired start time with the buttons "h" 16 and "min" 7 (see chapter "Setting the timer").
- When the desired time has been entered, release the button "prog" 15. The Timer is set.
- Enter in the desired coffee strength by turning the aroma knob 9.
- Press the button "auto" 8 until the green indicator 11 lights up.
- If you wish to deactivate the automatic brewing start, press the button "off" 12.

Cleaning and care

- Always remove the plug from the power socket before cleaning the appliance.

Danger of electrical shock

Before you clean the Coffee Maker, you must remove the power plug from the power socket.

Caution

When cleaning the Coffee Maker, under no circumstances may you submerge it in water or hold it under running water.

Risk of burns!

Always wait until the Coffee Maker has cooled down before cleaning it.

Take off the lid of the thermos jug 4, when cleaning (see Fig. 5)

- Do not use household detergents or sharp/pointed objects to remove soiling. These could damage the Coffee Maker.
- Wipe the housing of the Coffee Maker and the thermos jug 4 with a soft cloth lightly moistened with a soapy solution.
- After every brewing process remove the filter bag from the filter insert 6.

- Remove the filter and rinse the filter holder 1, the filter insert 6 and the thermos jug 4 under running water.
- Use a dry cloth to wipe it again.

Cleaning of the lid

- To clean the lid of the thermos jug r first disassemble the lid (See Fig. 5):
- Carefully pull off the silicone disc from the valve at the underside of the lid. When doing this, hold the valve, because it is pressed up by a spring from the other side.
- You now can take off the valve and the spring.
- Clean all parts with a mild soapy solution and wipe them off well.
- To assemble the lid again, proceed in reversed order.

Note:

Do not let the thermos jug with lid lie in soapy water and do not wash the parts in the dishwasher, as they could become leaky!

If you do not use the Coffee Maker for an extended period, store the power cable in the cable storage compartment 5 (Fig. 6).

Removing scale

Remove scale from the Coffee Maker regularly. If your water has a high degree of hardness, the coffee maker must be descaled after every 30 applications, low degrees of hardness need only be descaled after every 60 applications.

Use only descaling agents that are suitable for coffee machines and read up the instructions.

- Insert the descaling agent into the water tank 2.
- Fill it with enough water for max. 8 large cups.
- Turn the aroma knob 9 to "calc" to activate the descaling function.
- Press the button "on" 13. The red indicator 10 turns on and the indicator "calc" 14 is blinking.
- Wait until the solution has completely run through the Coffee Maker.

- When the procedure is complete, rinse the Coffee Maker through with 8 large cups of clean water twice.
- After descaling, the Coffee Maker switches itself off.

Rectifying malfunctions

The Coffee Maker does not start working.

- The appliance is not turned on.
Press the switch "on" **13** to turn on the Coffee Maker.
- The power plug is not plugged into the power socket. Connect the Coffee Maker to the mains by plugging the power plug into the power socket.
- The appliance has not been cooled down after the last brewing process. Wait for the appliance to cool down for about 5 minutes until you start the next brewing process.

The brewing process does not start at the determined time (Timer Function):

- The timer is not activated. Press the button "auto" **8** to activate the timer.
- The time is not set correctly. Check the present time and set the time if necessary.

The coffee is too strong/too weak:

- There is too little/too much water in the water tank. Fill in the correct amount of water.
- There is too much/too little coffee powder in the filter bag. Fill in less/more coffee powder.
- The coffee powder is grinded too fine/too rough. Choose a different type of ground coffee.
- The aroma control knob **9** is incorrectly adjusted. Reset the coffee strength on the aroma control knob **9**.

The brewing process lasts very long.

The appliance switches off during brewing.

The unit gets very loud during brewing.

Immoderate steam develops during brewing.

- The brewing system is scaled. remove the scale as described under "Removing scale".

Disposal



Do not dispose of the appliance in your normal domestic waste. This product is subject to the European guideline 2002/96/EC.

Dispose of the appliance through an approved disposal centre or at your community waste facility. Observe the currently applicable regulations. In case of doubt, please contact your waste disposal centre.



Dispose of all packaging materials in an environmentally responsible manner.

Warranty & Service

The warranty for this appliance is for 3 years from the date of purchase. The appliance has been manufactured with care and meticulously examined before delivery. Please retain your receipt as proof of purchase. In the event of a warranty claim, please make contact by telephone with our Service Department. Only in this way can a post-free despatch for your goods be assured.

The warranty covers only claims for material and manufacturing defects, but not for transport damage, for wearing parts or for damage to fragile components, e.g. buttons or batteries. This product is for private use only and is not intended for commercial use. The warranty is void in the case of abusive and improper handling, use of force and internal tampering not carried out by our authorized service branch. Your statutory rights are not restricted in any way by this warranty.

The warranty period will not be extended by repairs made under warranty. This applies also to replaced and repaired parts. Any damage and defects extant on purchase must be reported immediately after unpacking the appliance, at the latest, two days after the purchase date. Repairs made after the expiration of the warranty period are subject to payment.

Importer

KOMPERNASS GMBH
BURGSTRASSE 21
44867 BOCHUM, GERMANY

www.kompernass.com

GB DES UK LTD

Tel.: 0871 5000 700 (£ 0.10 / minute)

e-mail: support.uk@kompernass.com

IE Kompernass Service Ireland

Tel.: 1850 930 412 (0,082 EUR/Min.)

Standard call rates apply. Mobile operators may vary.

e-mail: support.ie@kompernass.com