



20V MAX* LITHIUM CORDLESS CHAIN SAW INSTRUCTION MANUAL

Model Number LCS120

Thank you for choosing Black & Decker! Go to www.BlackandDecker.com/NewOwner to register your new product.

PLEASE READ BEFORE RETURNING THIS PRODUCT FOR ANY REASON:

If you have a question or experience a problem with your Black & Decker purchase, go to WWW.BLACKANDDECKER.COM/INSTANTANSWERS for instant answers 24 hours a day.

If you can't find the answer or do not have access to the internet, call 1-800-544-6986 from 8 a.m. to 5 p.m. EST Mon. - Fri to speak with an agent.

Please have the catalog number available when you call.

**SAVE THIS MANUAL FOR FUTURE REFERENCE.
VEA EL ESPAÑOL EN LA CONTRAPORTADA.
POUR LE FRANÇAIS, VOIR LA COUVERTURE ARRIÈRE.**

INSTRUCTIVO DE OPERACIÓN, CENTROS DE SERVICIO Y PÓLIZA DE GARANTÍA. ADVERTENCIA: LÉASE ESTE INSTRUCTIVO ANTES DE USAR EL PRODUCTO.

Model # LCS120

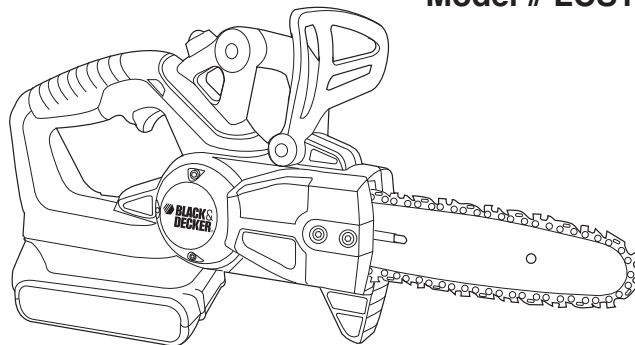

KEY INFORMATION YOU SHOULD KNOW:

- DO NOT OVER-TENSION CHAIN. Refer to "ADJUSTING CHAIN TENSION" for proper method of tensioning chain.
- Retighten chain frequently during first two hours of use.

*Maximum initial battery pack voltage (measured without a workload) is 20 volts. Measured under a workload, nominal voltage is 18.

TABLE OF CONTENTS

| | |
|---|----|
| Safety Guidelines - Definitions | 2 |
| Chain Saw Terms..... | 2 |
| Important Safety Instructions | 3 |
| Components..... | 6 |
| Important Safety Instructions for Battery Chargers..... | 6 |
| Important Safety Instructions for Battery Packs..... | 7 |
| Charging Procedure..... | 8 |
| Preparing Chain Saw for Use | 10 |
| Assembly | 10 |
| Operating the Chain Saw..... | 12 |
| Maintenance | 15 |
| Service Information | 16 |
| Full Two-Year Home Use Warranty..... | 16 |
| Troubleshooting | 17 |

SAFETY GUIDELINES - DEFINITIONS

It is important for you to read and understand this manual. The information it contains relates to protecting YOUR SAFETY and PREVENTING PROBLEMS. The symbols below are used to help you recognize this information.

⚠ DANGER: Indicates an imminently hazardous situation which, if not avoided, will result in death or serious injury.

⚠ WARNING: Indicates a potentially hazardous situation which, if not avoided, could result in death or serious injury.

⚠ CAUTION: Indicates a potentially hazardous situation which, if not avoided, may result in minor or moderate injury.

CAUTION: Used without the safety alert symbol indicates a potentially hazardous situation which, if not avoided, may result in property damage.

INTENDED USE

Your Black & Decker Cordless Chain Saw is ideal for pruning applications and cutting small logs up to 8 inches (203 mm) in diameter. This tool is intended for consumer use only.

CHAIN SAW NAMES AND TERMS

- **Bucking** - The process of cross cutting a felled tree or log into lengths.
- **Motor Brake** - A device used to stop the saw chain when the trigger is released.
- **Chain Saw Powerhead** - A chain saw without the saw chain and guide bar.
- **Drive Sprocket or Sprocket** - The toothed part that drives the saw chain.
- **Felling** - The process of cutting down a tree.
- **Felling Back Cut** - The final cut in a tree felling operation made on the opposite side of the tree from the notching cut.
- **Front Handle** - The support handle located at or toward the front of the chain saw.
- **Front Hand Guard** - A structural barrier between the front handle of a chain saw and the guide bar, typically located close to the hand position on the front handle and sometimes employed as an activating lever for a chain brake.
- **Guide Bar** - A solid railed structure that supports and guides the saw chain.
- **Guide Bar Scabbard** - Enclosure fitted over guide bar to prevent tooth contact when saw is not in use.
- **Kickback** - The backward or upward motion, or both of the guide bar occurring when the saw chain near the nose of the top area of the guide bar contacts any object such as a log or branch, or when the wood closes in and pinches the saw chain in the cut.
- **Kickback, Pinch** - The rapid pushback of the saw which can occur when the wood closes in and pinches the moving saw chain in the cut along the top of the guide bar.
- **Kickback, Rotational** - The rapid upward and backward motion of the saw which can occur when the moving saw chain near the

upper portion of the tip of the guide bar contacts an object, such as a log or branch.

- **Limbing** - Removing the branches from a fallen tree
- **Low-Kickback Chain** - A chain that complies with the kickback performance requirements of ANSI B175.1-1991 (when tested on a representative sample of chain saws.)
- **Normal Cutting Position** - Those positions assumed in performing the bucking and felling cuts.
- **Notching Undercut** - A notch cut in a tree that directs the tree's fall.
- **Oiler Control** - A system for oiling the guide bar and saw chain.
- **Rear Handle** - The support handle located at or toward the rear of the saw.
- **Reduced Kickback Guide Bar** - A guide bar which has been demonstrated to reduce kickback significantly.
- **Replacement Saw Chain** - A chain that complies with kickback performance requirements of ANSI B175.1-2000 when tested with specific chain saws. It may not meet the ANSI performance requirements when used with other saws.
- **Saw Chain** - A loop of chain having cutting teeth, that cut the wood, and that is driven by the motor and is supported by the guide bar.
- **Ribbed Bumper** - The ribs used when felling or bucking to pivot the saw and maintain position while sawing.
- **Switch** - A device that when operated will complete or interrupt an electrical power circuit to the motor of the chain saw.
- **Switch Linkage** - The mechanism that transmits motion from a trigger to the switch.
- **Switch Lockout** - A movable stop that prevents the unintentional operation of the switch until manually actuated.

IMPORTANT SAFETY INSTRUCTIONS

⚠ **WARNING:** When using a battery operated chain saw, basic safety precautions should always be followed to reduce risk of fire, electric shock, and personal injury, including the following:

READ ALL INSTRUCTIONS

SAFETY INSTRUCTIONS AND WARNINGS FOR CHAIN SAWS

- **Keep Work Area Clean** - Cluttered areas invite injuries. Do not start cutting until you have a clear work area, secure footing, and a planned retreat path from the falling tree.
- **Consider Work Area Environment** - Use extreme caution when cutting small size brush and saplings because the slender material may catch the saw chain and be whipped toward you or pull you off balance. When cutting a limb that is under tension be alert for spring back so that you will not be struck when the tension in the wood fibers is released. Do not expose chain saw to rain or snow. Do not use chain saw in damp or wet locations or while it is raining or snowing. Do not use chain saw in the presence of flammable liquids or gases or enclosed concentrations of dust. Cut only when visibility and light are sufficient to see clearly
- **Keep Children, Bystanders, Visitors and Animals Away** - Do not let visitors contact chain saw. All visitors should be kept away from work area.
- **Store Idle Chain Saw** - When not in use, chain saws should be stored in a dry, and high or locked-up place - out of the reach of children. When storing saw, always remove battery and use a scabbard or carrying case.
- **Don't Force Chain Saw** - It will do the job better and safer at the rate for which it was intended.
- **Use Right Tool** - Cut wood only. Don't use chain saw for purpose not intended - for example - Don't use chain saw for cutting plastic, metal, masonry, non-wood building materials.
- **Dress Properly** - Do not wear loose clothing or jewelry. Keep your hair, clothing, and gloves away from moving parts. Loose clothing, jewelry, or long hair can be caught in moving parts. Wear protective hair covering to contain long hair. Air vents cover moving parts and should be avoided. Protective non-slip gloves and non-skid footwear are recommended when working outdoors. Always wear heavy, long pants or other protection for your legs.
- **Use Safety Glasses** - Also use safety footwear; snug fitting clothing; protective gloves; proper hearing, respiratory, and head protection.
- **Carrying Saw** - Carry the chain saw by the front handle with the

saw stopped, finger off the switch, the guide bar and saw chain to the rear. Remove battery and use scabbard when transporting saw.

- **Maintain Chain Saw With Care** - Keep tools sharp and clean for better and safer performance. Follow instructions for lubricating and changing accessories. Keep handles dry, clean, and free from oil and grease.

- **Disconnect Battery** - Disconnect battery from chain saw when not in use, before servicing, when tensioning chain, and when changing accessories and attachments, such as saw chain.

- **Stay Alert** - Watch what you are doing. Use common sense. Do not operate chain saw when you are tired, ill, or under the influence of alcohol, drugs, or medication. Keep all parts of the body away from the saw chain when the motor is operating. Before you start the saw, make sure the saw chain is not contacting anything. When cutting through wood, remember the chain saw cuts quickly and will continue its downward or upward path. Stay out of its path.

- **Check Damaged Parts** - Before further use of the chain saw, any part that is damaged should be carefully checked to determine that it will operate properly and perform its intended function. Check for alignment of moving parts, binding of moving parts, breakage of parts, mounting, and any other conditions that may affect its operation. A guard or other part that is damaged should be properly repaired or replaced by an authorized service center unless otherwise indicated elsewhere in this instruction manual. Have defective switches replaced by authorized service center. Do not use chain saw if switch does not turn it on and off. Do not operate a chain saw that is damaged, improperly adjusted, or is not completely and securely assembled. Be sure that the saw chain stops moving when the trigger is released.

- **Guard Against Kickback**

⚠ WARNING: KICKBACK may occur when the nose or tip of the guide bar touches an object, or when the wood closes in and pinches the saw chain in the cut. Tip contact in some cases may cause a lightning fast reverse reaction, kicking the guide bar up and back towards the operator. Pinching the saw chain along the top of the guide bar may push the guide bar rapidly back towards the operator. Either of these reactions may cause you to lose control of the saw which could result in serious injury to user.

The following precautions should be followed to minimize kickback:

(1.) Grip Saw Firmly. Hold the chain saw firmly with both hands when the motor is running. Use a firm grip with thumbs and fingers encircling the chain saw handles. Chain saw will pull forward when cutting on the bottom edge of the bar, and push backward when cutting along the top edge of the bar.

(2.) Do not over reach.

(3.) Keep proper footing and balance at all times.

(4.) Don't let the nose of the guide bar contact a log, branch, ground or other obstruction.

(5.) Don't cut above shoulder height.

(6.) Use devices such as low kickback chain and reduced kickback guide bars that reduce the risks associated with kickback.

(7.) Only use replacement bars and chains specified by the manufacturer or the equivalent.

(8.) Never let the moving chain contact any object at the tip of the guide bar.

(9.) Keep the working area free from obstructions such as other trees, branches, rocks, fences, stumps, etc. Eliminate or avoid any obstruction that your saw chain could hit while you are cutting through a particular log or branch.

(10.) Keep your saw chain sharp and properly tensioned. A loose or dull chain can increase the chance of kickback. Check tension at regular intervals with the motor stopped and battery removed, never with the motor running.

(11.) Begin and continue cutting only with the chain moving at full speed. If the chain is moving at a slower speed, there is a greater chance for kickback to occur.

(12.) Cut one log at a time.

(13.) Use extreme caution when re-entering a previous cut. Engage ribbed bumpers into wood and allow chain to reach full speed before proceeding with cut.

(14.) Do not attempt plunge cuts or bore cuts.

(15.) Watch for shifting logs or other forces that could close a cut and pinch or fall into chain.

- **Power Supply** - Connect chain saw battery charger to correct voltage, that is, be sure that the voltage supplied is the same as that specified on the nameplate of the tool.

Kickback Safety Features

⚠ **WARNING:** The following features are included on your saw to help reduce the hazard of kickback; however such features will not totally eliminate this dangerous reaction. As a chain saw user do not rely only on safety devices. You must follow all safety precautions, instructions, and maintenance in this manual to help avoid kickback and other forces which can result in serious injury.

- **Reduced-Kickback Guide Bar**, designed with a small radius tip which reduces the size of the kickback danger zone on bar tip. A reduced - kickback guide bar is one which has been demonstrated to significantly reduce the number and seriousness of kickbacks when tested in accordance with safety requirements for electric chain saws.
- **Low-Kickback Chain**, designed with a contoured depth gauge and guard link which deflect kickback force and allow wood to gradually ride into the cutter. A low-kickback chain is a chain which has met kickback performance requirements of ANSI B175.1-1991.
- **Do not operate chain saw while in a tree, on a ladder, on a scaffold, or from any unstable surface.**
- **Hold tool by insulated gripping surfaces when performing an operation where the cutting tool may contact hidden wiring.** Contact with a "live" wire will make exposed metal parts of the tool "live" and shock the operator.
- **Do not attempt operations beyond your capacity or experience.** Read thoroughly and understand completely all instructions in this manual.
- **Before you start chain saw**, make sure saw chain is not contacting any object.
- **Do not operate a chain saw with one hand! Serious injury to the operator, helpers, or bystanders may result from one handed operation.** A chain saw is intended for two-handed use only.
- **Keep the handles dry, clean, and free of oil or grease.**
- **Do not allow dirt, debris, or sawdust to build up on the motor or outside air vents.**
- **Stop the chain saw before setting it down.**
- **Do not cut vines and/or small under brush.**

- **Use extreme caution when cutting small size brush and saplings** because slender material may catch the saw chain and be whipped toward you or pull you off balance.

⚠ **WARNING:** Some dust created by power sanding, sawing, grinding, drilling, and other construction activities contains chemicals known to the State of California to cause cancer, birth defects or other reproductive harm. Some examples of these chemicals are:

- lead from lead-based paints,
- crystalline silica from bricks and cement and other masonry products, and
- arsenic and chromium from chemically-treated lumber.

Your risk from these exposures varies, depending on how often you do this type of work. To reduce your exposure to these chemicals: work in a well ventilated area, and work with approved safety equipment, such as those dust masks that are specially designed to filter out microscopic particles.



- **Avoid prolonged contact with dust from power sanding, sawing, grinding, drilling, and other construction activities. Wear protective clothing and wash exposed areas with soap and water.** Allowing dust to get into your mouth, eyes, or lay on the skin may promote absorption of harmful chemicals.

⚠ **WARNING: Use of this tool can generate and/or disburse dust, which may cause serious and permanent respiratory or other injury.** Always use NIOSH/OSHA approved respiratory protection appropriate for the dust exposure. Direct particles away from face and body.

SAVE THESE INSTRUCTIONS

SYMBOLS

The label on your tool may include the following symbols.

| | |
|--|--|
| <i>V</i>volts | <i>A</i>amperes |
| <i>Hz</i>hertz | <i>W</i>watts |
| <i>min</i>minutes | <i>~</i>alternating current |
| <i>---</i>direct current | <i>n</i> <i>o</i>no load speed |
| Class II Construction | earthing terminal |
| safety alert symbol | <i>.../min</i>revolutions per minute |

COMPONENTS

Before using your Chain Saw familiarize yourself with all operating and safety features.

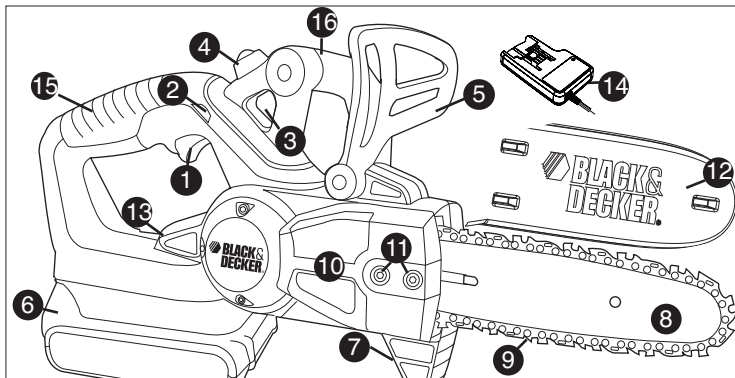

- | | |
|----------------------|------------------------|
| 1. Trigger Switch | 9. Saw Chain |
| 2. Lock Off Button | 10. Sprocket Cover |
| 3. Oil Reservoir | 11. Allen Head Screws |
| 4. Oil Reservoir Cap | 12. Guide Bar Scabbard |
| 5. Front Hand Guard | 13. Wrench |
| 6. Battery | 14. Charger |
| 7. Ribbed Bumper | 15. Rear Handle |
| 8. Guide Bar | 16. Front Handle |

IMPORTANT SAFETY INSTRUCTIONS FOR BATTERY CHARGERS

SAVE THESE INSTRUCTIONS: This manual contains important safety instructions for battery chargers.

- Before using charger, read all instructions and cautionary markings on charger, battery pack, and product using battery pack.

⚠ WARNING: Shock hazard. Do not allow any liquid to get inside charger.

⚠ CAUTION: Burn hazard. To reduce the risk of injury, charge only designated **Black & Decker** batteries. Other types of batteries may burst causing personal injury and damage.

⚠ CAUTION: Under certain conditions, with the charger plugged in to the power supply, the charger can be shorted by foreign material. Foreign materials of a conductive nature such as, but not limited to, steel wool, aluminum foil, or any buildup of metallic particles should be kept away from charger cavities. Always unplug the charger from the power supply when there is no battery pack in the cavity. Unplug charger before attempting to clean.

- **The charger supplied with this product is intended to be plugged in such that it is correctly orientated in a vertical or floor mount position.**
- **DO NOT attempt to charge the battery pack with any chargers other than the ones in this manual.** *The charger and battery pack are specifically designed to work together.*
- **These chargers are not intended for any uses other than charging designated **Black & Decker** rechargeable batteries.** *Any other uses may result in risk of fire, electric shock or electrocution.*
- **Do not expose charger to rain or snow.**
- **Pull by plug rather than cord when disconnecting charger.** *This will reduce risk of damage to electric plug and cord.*
- **Make sure that cord is located so that it will not be stepped on, tripped over, or otherwise subjected to damage or stress.**

- **Do not use an extension cord unless it is absolutely necessary.** Use of improper extension cord could result in risk of fire, electric shock, or electrocution.
- **An extension cord must have adequate wire size (AWG or American Wire Gauge) for safety.** The smaller the gauge number of the wire, the greater the capacity of the cable, that is 16 gauge has more capacity than 18 gauge. When using more than one extension to make up the total length, be sure each individual extension contains at least the minimum wire size.

Recommended Minimum Wire Size for Extension Cords

| Volts | Minimum Gauge for Cord Sets | | | | |
|---------------|------------------------------|---------------|---------|---------------------|-----------------|
| | Total Length of Cord in Feet | | | | |
| 120V | 0-25 | 26-50 | 51-100 | 101-150 | |
| 240V | 0-50 | 51-100 | 101-200 | 201-300 | |
| Ampere Rating | | | | | |
| More Than | | Not more Than | | American Wire Gauge | |
| 0 | - | 6 | 18 | 16 | 14 |
| 6 | - | 10 | 18 | 16 | 14 |
| 10 | - | 12 | 16 | 16 | 14 |
| 12 | - | 16 | 14 | 12 | Not Recommended |

- **Do not place any object on top of charger or place the charger on a soft surface that might block the ventilation slots and result in excessive internal heat. Place the charger in a position away from any heat source.** The charger is ventilated through slots in the top and the bottom of the housing.
- **Do not mount charger on wall or permanently affix charger to any surface.** The charger is intended to use on a flat, stable surface (i.e., table top, bench top).
- **Do not operate charger with damaged cord or plug — have them replaced immediately.**
- **Do not operate charger if it has received a sharp blow, been dropped, or otherwise damaged in any way. Take it to an authorized service center.**
- **Do not disassemble charger; take it to an authorized service**

center when service or repair is required. Incorrect reassembly may result in a risk of electric shock, electrocution or fire.

- **Disconnect the charger from the outlet before attempting any cleaning.** This will reduce the risk of electric shock. Removing the battery pack will not reduce this risk.
- **NEVER attempt to connect 2 chargers together.**
- **The charger is designed to operate on standard household electrical power (120 Volts). Do not attempt to use it on any other voltage.**

SAVE THESE INSTRUCTIONS

IMPORTANT SAFETY WARNINGS FOR BATTERY PACKS

⚠ WARNING: For safe operation, read this manual and manuals originally supplied with tool before using the charger.

The battery pack is not fully charged out of the carton. Before using the battery pack and charger, read the safety instructions below. Then follow charging procedures outlined.

READ ALL INSTRUCTIONS

- **Do not incinerate the battery pack even if it is severely damaged or is completely worn out.** The battery pack can explode in a fire. Toxic fumes and materials are created when battery packs are burned.
- **Do not charge or use battery in explosive atmospheres, such as in the presence of flammable liquids, gases or dust.** Inserting or removing the battery from the charger may ignite the dust or fumes.
- **If battery contents come into contact with the skin, immediately wash area with mild soap and water.** If battery liquid gets into the eye, rinse water over the open eye for 15 minutes or until irritation ceases. If medical attention is needed, the battery electrolyte for Li-ion batteries is composed of a mixture of liquid organic carbonates and lithium salts.

- **Contents of opened battery cells may cause respiratory irritation.** Provide fresh air. If symptoms persist, seek medical attention.

⚠ WARNING: Burn hazard. Battery liquid may be flammable if exposed to spark or flame.

- Charge the battery packs only in **Black & Decker** chargers.
- **DO NOT splash or immerse in water or other liquids.** This may cause premature cell failure.
- **Do not store or use the tool and battery pack in locations where the temperature may reach or exceed 105°F (40°C) (such as outside sheds or metal buildings in summer).**

⚠ WARNING: Never attempt to open the battery pack for any reason. If battery pack case is cracked or damaged, do not insert into charger. Do not crush, drop or damage battery pack. Do not use a battery pack or charger that has received a sharp blow, been dropped, run over or damaged in any way (i.e., pierced with a nail, hit with a hammer, stepped on). Damaged battery packs should be returned to service center for recycling.

⚠ WARNING: Fire hazard. Do not store or carry battery so that metal objects can contact exposed battery terminals. For example, do not place battery in aprons, pockets, tool boxes, product kit boxes, drawers, etc., with loose nails, screws, keys, etc. **Transporting batteries can possibly cause fires if the battery terminals inadvertently come in contact with conductive materials such as keys, coins, hand tools and the like.** The US Department of Transportation Hazardous Material Regulations (HMR) actually prohibit transporting batteries in commerce or on airplanes (i.e., packed in suitcases and carry-on luggage) UNLESS they are properly protected from short circuits. So when transporting individual batteries, make sure that the battery terminals are protected and well insulated from materials that could contact them and cause a short circuit. **NOTE: LI-ION batteries should not be put in checked baggage.**

STORAGE RECOMMENDATIONS

1. The best storage place is one that is cool and dry away from direct sunlight and excess heat or cold.
2. Long storage will not harm the battery pack or charger.

CHARGING PROCEDURE

The standard charger provided will charge a fully depleted battery in about 8 hours.

1. Plug the charger into an appropriate outlet before inserting the battery pack.
2. Insert the battery pack into the charger as shown in **figure A**.

 3. The green LED will flash indicating that the battery is being charged.

 4. The completion of charge is indicated by the green LED remaining on continuously. The pack is fully charged and may be used at this time or left on the charger.

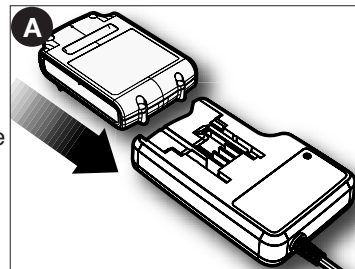

Recharge discharged batteries as soon as possible after use or battery life may be greatly diminished. It is recommended that the batteries be recharged after each use.

CHARGER DIAGNOSTICS

This charger is designed to detect certain problems that can arise with the battery packs or the power source. Problems are indicated by one LED flashing in different patterns.

BAD BATTERY

 The charger can detect a weak or damaged battery. The red LED flashes in the pattern indicated on the label. If you see this bad battery blink pattern, do not continue to charge the battery. Return it to a service center or a collection site for recycling.

HOT/COLD PACK DELAY

 When the charger detects a battery that is excessively hot or excessively cold, it automatically starts a Hot/Cold Pack

Delay, suspending charging until the battery has normalized. After this happens, the charger automatically switches to the Pack Charging mode. This feature ensures maximum battery life. The red LED flashes in the pattern indicated on the label when the hot / cold pack delay is detected.

LEAVING THE BATTERY IN THE CHARGER

The charger and battery pack can be left connected with the green LED glowing indefinitely. The charger will keep the battery pack fresh and fully charged.

IMPORTANT CHARGING NOTES

1. Longest life and best performance can be obtained if the battery pack is charged when the air temperature is between 60°F and 80°F (16°- 27°C). DO NOT charge the battery pack in an air temperature below +40°F (+4.5°C), or above +105°F (+40.5°C). This is important and will prevent serious damage to the battery pack.

2. The charger and battery pack may become warm to touch while charging. This is a normal condition, and does not indicate a problem. To facilitate the cooling of the battery pack after use, avoid placing the charger or battery pack in a warm environment such as in a metal shed, or an uninsulated trailer.

3. If the battery pack does not charge properly:
- Check current at receptacle by plugging in a lamp or other appliance
 - Check to see if receptacle is connected to a light switch which turns power off when you turn out the lights.
 - Move charger and battery pack to a location where the surrounding air temperature is approximately 60°F and 80°F (16°- 27°C)
 - If charging problems persist, take the tool, battery pack and charger to your local service center.

4. The battery pack should be recharged when it fails to produce sufficient power on jobs which were easily done previously. DO NOT CONTINUE to use under these conditions. Follow the charging procedure. You may also charge a partially used pack whenever you desire with no adverse affect on the battery pack.

5. Foreign materials of a conductive nature such as, but not limited to, steel wool, aluminum foil, or any buildup of metallic particles should be kept away from charger cavities. Always unplug the charger from the power supply when there is no battery pack in the cavity. Unplug charger before attempting to clean.

6. Do not freeze or immerse charger in water or any other liquid.

⚠ WARNING: Shock hazard. Do not allow any liquid to get inside charger. *Never attempt to open the battery pack for any reason. If the plastic housing of the battery pack breaks or cracks, return to a service center for recycling.*

INSTALLING / REMOVING BATTERY PACK

⚠ WARNING: *Make certain the lock-off button is engaged to prevent switch actuation before removing or installing battery.*

TO INSTALL BATTERY PACK:
Insert battery pack into tool until an audible click is heard (**figure B/C**).

TO REMOVE BATTERY PACK:
Depress the battery release button in the back of the battery pack and pull battery pack out of tool (**figure B/C**).

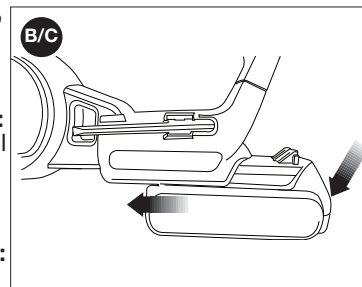

PREPARING YOUR CHAIN SAW FOR USE

⚠ WARNING: Read and understand all instructions. Failure to follow all instructions listed below may result in electric shock, fire and/or serious personal injury.

ASSEMBLY

Installing the Guide Bar and Saw Chain

⚠ CAUTION: Sharp chain. Always wear protective gloves when handling the chain. The chain is sharp and can cut you when it is not running.

⚠ WARNING: Sharp moving chain. To prevent accidental operation, insure that battery is disconnected from the tool before performing the following operations. Failure to do this could result in serious personal injury.

The saw chain and guide bar are packed separately in the carton inside the scabbard. The chain has been placed on the guide bar at the factory to insure that the teeth are facing in the proper direction when you first attach it. Should the chain come off of the guide bar, refer to the section “Replacing the Chain” for proper tooth orientation.

- Place the saw on a firm surface. Rotate the two allen head screws (11) counterclockwise with the wrench (13) provided as shown in **figure D**.
- Remove sprocket cover (10) and allen head screws (11).
- Cut the plastic wire tie holding the guide bar scabbard (12) to the guide bar (8). Be sure to cut away from yourself to prevent injury if cutting instrument should slip.

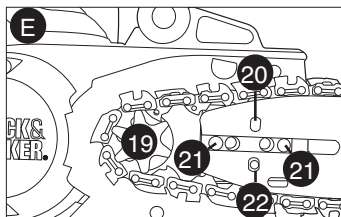
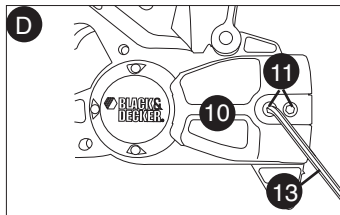

- Wearing protective gloves, grasp the saw chain (9) and guide bar (8) with one hand and pull the guide bar scabbard (12) off with your free hand.
- Place the saw chain and guide bar assembly around the sprocket (19). Check to make sure that the slot (20) in the guide bar (8) is over the two location pins (21) shown in **figure E** and that the hole below the slot is located over the adjustment pin (22).
- Replace sprocket cover (10) and thread allen head screws (11) in with wrench until snug, then back wrench off one full turn.
- Cut the plastic wire tie holding the saw chain to the guide bar. Be sure to cut away from yourself to prevent injury if cutting instrument should slip.
- Pull bar nose up and keep it up as you adjust tension.
- With the flat screwdriver end of the wrench provided rotate the tension adjustment screw (23) in the front of the housing clockwise to increase the chain tension as in **figure F**.
- **Follow instructions in “Adjusting Chain Tension” section.**
- While still holding the bar nose up, tighten the rear allen screw first, then tighten the front allen screw. Make sure both allen screws are securely tightened. Do not overtighten.
- When the chain is new check the tension frequently (after disconnecting battery) during the first 2 hours of use as a new chain stretches slightly.

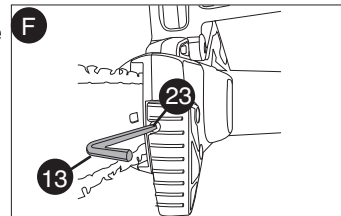

Replacing the Saw Chain

⚠ CAUTION: Sharp chain. Always wear protective gloves when handling the chain. The chain is sharp and can cut you when it is not running.

⚠ WARNING: Sharp moving chain. To prevent accidental operation, insure that battery is disconnected from the tool before performing the following operations. Failure to do this could result in serious personal injury.

- Place the saw on a firm surface. Rotate the two allen head screws (11) counterclockwise with the wrench (13) provided as shown in **figure D**.

- To remove the saw chain (9), rotate the tension adjustment screw (23) in the front of the housing using the flat screwdriver end of the wrench (13) as shown in **figure F**. Turning the screw counterclockwise allows the guide bar to recede and reduces the tension on the chain so that it may be removed.

- Remove sprocket cover (10) and allen head screws (11).
- Lift the worn saw chain (9) out of the groove in the guide bar (8).
- Place new chain in groove of guide bar making sure saw teeth are facing correct direction by matching arrow on chain with graphic on housing shown in **figure G**.

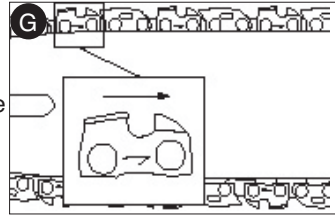

- Place the saw chain and guide bar assembly around the sprocket (19). Check to make sure that the slot (20) in the guide bar (8) is over the two location pins (21) shown in **figure E** and that the hole below the slot is located over the adjustment pin (22).
- Replace sprocket cover (10) and thread allen head screws (11) in with wrench until snug, then back wrench off one full turn.
- Pull bar nose up and keep it up as you adjust tension **Figure G1**.
- Rotate the tension adjustment screw (23) in the front of the housing clockwise to increase the chain tension as in **Figure F**.
- Follow instructions in “Adjusting Chain Tension” section.**
- While still holding the bar nose up, securely tighten the rear allen screw (11) first, then tighten the front allen screw.
- When the chain is new check the tension frequently (after disconnecting battery) during the first 2 hours of use as a new chain stretches slightly.

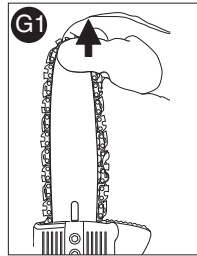

Adjusting Chain Tension

⚠ CAUTION: Sharp chain. Always wear protective gloves when handling the chain. The chain is sharp and can cut you when it is not running.

⚠ WARNING: Sharp moving chain. To prevent accidental operation, insure that battery is disconnected from the tool before performing the following operations. Failure to do this could result in serious personal injury.

- With the saw still on a firm surface check the chain tension. The tension is correct when the chain snaps back after being pulled 1/8 inch (3mm) away from the guide bar (8) with light force from the middle finger and thumb as shown in **figure H**. There should be no “sag” between the guide bar and the chain on the underside as shown in **figure I**.

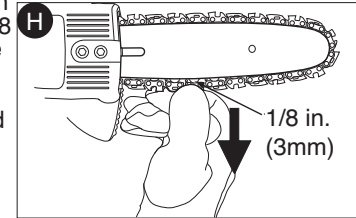

- To adjust saw chain tension, loosen the allen head screws (11).
- Rotate the tension adjustment screw (23) in the front of the housing using the flat screwdriver end of the wrench (13) as shown in **figure F**.
- Do not over-tension the chain as this will lead to excessive wear and will reduce the life of the bar and chain. Overtensioning also reduces the amount of cuts you will get per battery charge.
- Once chain tension is correct, tighten allen head screws (11).
- When the chain is new check the tension frequently (after disconnecting battery) during the first 2 hours of use as a new chain stretches slightly.

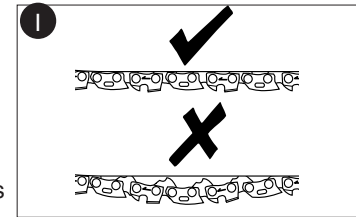

Chain Oiling

NOTES:

- A high quality bar and chain oil or SAE30 weight motor oil should be used for chain and bar lubrication. Never use waste oil or very thick oil. These may damage your chain saw.
- Replace oil reservoir cap immediately after filling oil reservoir. Failure to do so will allow excessive oil to drip out of oiling outlet.
- It is normal for a small amount of excess oil to drip from the chain saw bar and chain during storage. Do not store chain saw on top of anything that may be damaged by the dripping oil.
- Remove the oil reservoir cap (4) and fill the oil reservoir (3) with the above recommended oil. For best results, keep reservoir over half full.
- Lubricate the saw chain as shown in **figure J** by pressing the bulb on the oil reservoir cap (4) twice before making each cut. Hold bulb down for 3-4 seconds.
- Because the saw uses a gravity fed oiling system, the saw should be pointed downward and slightly to the right when applying oil to the chain.

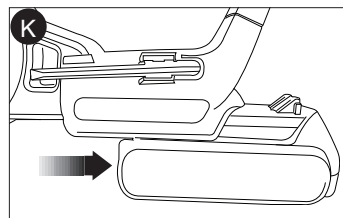
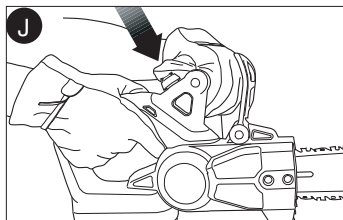

Transporting Saw

- Always remove the battery (6) from the tool (**figure K**) and cover the guide bar (8) with the scabbard (12) (**figure L**) when transporting the saw. See the warning under “Battery Cap Information” for additional information on transporting the battery.

OPERATING THE CHAIN SAW

⚠ WARNING: Read and understand all instructions. Failure to follow all instructions listed below may result in electric shock, fire and/or serious personal injury.

- **Guard Against Kickback which can result in severe injury or death.** See **Important Safety Instructions** “Guard Against Kickback”, to avoid the risk of kickback.
- **Do not overreach. Do not cut above chest height. Make sure your footing is firm.** Keep feet apart. Divide your weight evenly on both feet.
- **Use a firm grip with your left hand on the front handle (16) and your right hand on the rear handle (15)** so that your body is to the left of the guide bar.
- **Do not hold chain saw by front hand guard (5).** Keep elbow of left arm locked so that left arm is straight to withstand a kickback.
⚠ WARNING: Never use a cross-handed grip (left hand on the rear handle and right hand on the front handle).
⚠ WARNING: Never allow any part of your body to be in line with the guide bar (8) when operating the chain saw.
- **Never operate while in a tree, in any awkward position or on a ladder or other unstable surface.** You may lose control of saw causing severe injury.
- **Keep the chain saw running at full speed the entire time you are cutting.**
- **Allow the chain to cut for you.** Exert only light pressure. Do not put pressure on chain saw at end of cut.

Connecting the Battery

- Place the battery (6) into the tool as shown in **figure M** and be certain that it is inserted fully into the tool cavity until it “clicks” into place. To remove the battery from the tool, press down on the release button (18) on the back of the battery and slide out.

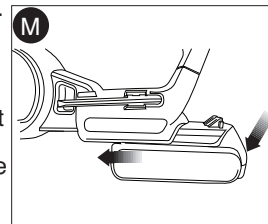

Switch

- Always be sure of your footing and grip the chain saw firmly with both hands with the thumb and fingers encircling both handles.
- To turn the tool ON push the lock off button (2) to either side and squeeze the trigger switch (1) with your fingers as shown in **figure N**. (Once the tool is running you can release the lock off button.)
- To turn the tool OFF, release the trigger switch.

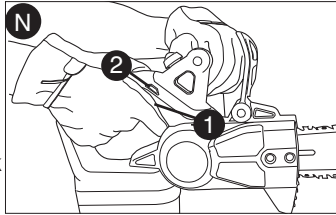

Chain Braking System

Your chain saw is equipped with a motor chain braking system which will stop the chain quickly each time you release the trigger. This system should be tested before every use.

Saw Chain Sharpness

The cutters will dull immediately if they touch the ground or a nail while cutting. Refer to “Sharpening the Chain”.

Saw Chain Tension

This should be done regularly. Refer to “Adjusting Chain Tension”.

Common Cutting Techniques

Felling

Felling is the process of cutting down a tree. Be sure battery is fully charged before felling a tree so you can finish on a single charge. Do not fell trees in high wind conditions.

Bucking is the process of cutting a felled tree or log into lengths. When bucking and felling operations are being performed by two or more persons, at the same time, the felling operation should be separated from the bucking operation by a distance of at least twice the height of the tree being felled. Trees should not be felled in a manner that would endanger any person, strike any utility line or cause any property damage. If the tree does make contact with

any utility line, the utility company should be notified immediately. Scrutinize the surrounding overhead for dead or broken limbs or branches which may fall during the felling process. The chain saw operator should keep on the uphill side of the terrain as the tree is likely to roll or slide downhill after it is felled.

- **(Figure O)** A retreat path should be planned and cleared as necessary before cuts are started. The retreat path should extend back and diagonally to the rear of the expected line of fall.
- Before felling is started, consider the natural lean of the tree, the location of larger branches and the wind direction to judge which way the tree will fall. Have wedges (wood, plastic or aluminum) and a heavy mallet handy.

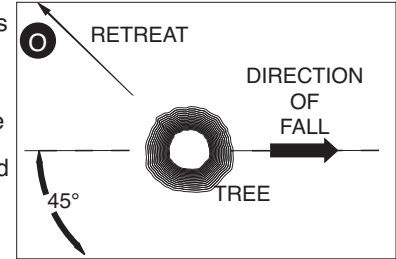

- **(Figure P)** Notching Undercut - Make the notch 1/3 of the diameter of the tree, perpendicular to the direction of the fall. Make the lower horizontal notching cut first. This will help to avoid pinching of either the saw chain or the guide bar when the second notch is being made.

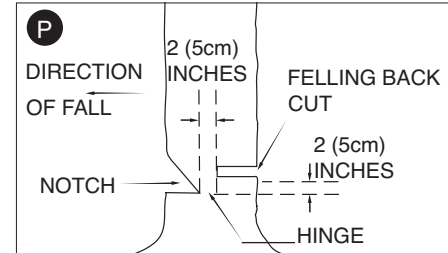

- **(Figure Q)** Felling Back Cut - Make the felling back cut at least 2 inches (51mm) higher than the horizontal notching cut. Keep the felling back cut parallel to the horizontal notching cut. Make the

felling back cut so enough wood is left to act as a hinge. The hinge wood keeps the tree from twisting and falling in the wrong direction. Do not cut through the hinge.

- **(Figure Q)** As the felling cut gets close to the hinge the tree should begin to fall. If there is any chance that the tree may not fall in the desired direction or it may rock back and bind the saw chain, stop cutting before the felling cut is complete and use wedges to open the cut and drop the tree along the desired line of fall. When the tree begins to fall remove the chain saw from the cut, stop the motor, put the chain saw down, then use the retreat path planned. Be alert for overhead limbs falling and watch your footing.

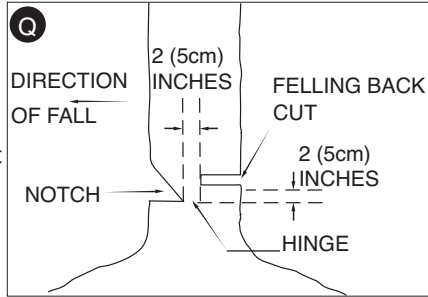

Limbing (figure R)

Limbing is removing the branches from a fallen tree. When limbing, leave larger lower limbs to support the log off the ground. Remove the small limbs in one cut. Branches under tension should be cut from the bottom up to avoid binding the chain saw. Trim limbs from opposite side

keeping tree stem between you and saw. Never make cuts with saw between your legs or straddle the limb to be cut.

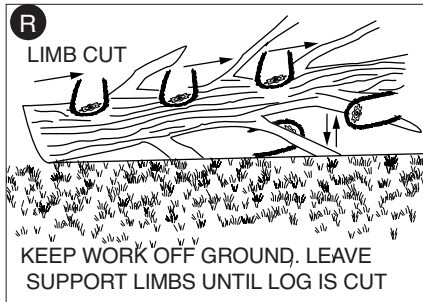

Bucking

Bucking is cutting a felled tree or log into lengths. How you should cut depends on how the log is supported. Use a saw horse **(figure W)** whenever possible.

Always start a cut with the chain running at full speed and the ribbed bumper (7) in contact with the wood. To complete the cut use a pivoting action of the ribbed bumper against the wood.

- **(Figure S)** When supported along its whole length
Make a cut from the top (overbuck), but avoid cutting the earth as this will dull your saw quickly.

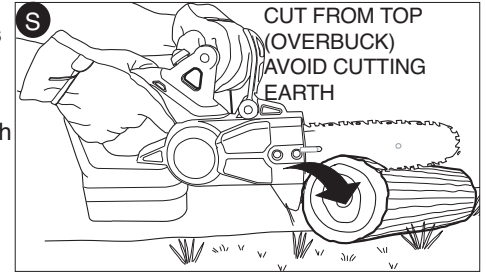

- **(Figure T)** When supported at one end
First, cut 1/3 the diameter from the underside (underbuck). Then make the finished cut by overbucking to meet the first cut.

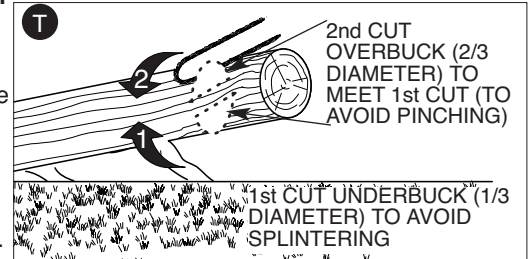

• **(Figure U) When supported at both ends**

First, cut 1/3 down from the top overbuck. Then make the finished cut by underbucking the lower 2/3 to meet the first cut.

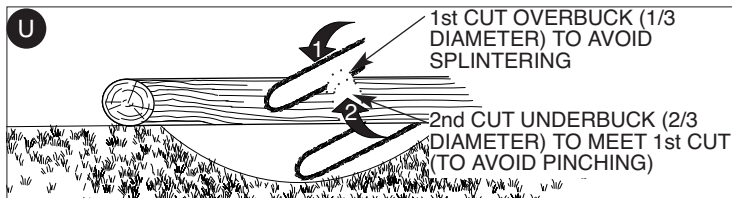

• **(Figure V) When on a slope**

Always stand on the uphill side of the log. When "cutting through", to maintain complete control release the cutting pressure near the end of the cut without relaxing your grip on the chain saw handles. Don't let the chain contact the ground. After completing the cut, wait for the saw chain to stop before you move the chain saw. Always stop the motor before moving from tree to tree.

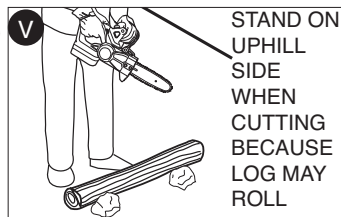

• **(Figure W) When using a saw horse**

This is strongly recommended whenever possible. Position the log in a stable position. Always cut on the outside of the saw horse arms.

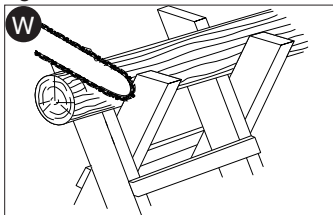

CARE AND MAINTENANCE

Use only mild soap and damp cloth to clean the tool. Do not use solvents to clean the plastic housing of the saw. Never let any liquid get inside the tool; never immerse any part of the tool into a liquid.

IMPORTANT: To assure product SAFETY and RELIABILITY, repairs, maintenance and adjustment should be performed by authorized service centers or other qualified service organizations, always using identical replacement parts.

Regular maintenance ensures a long effective life for your chain saw. We recommend you make the following checks on a regular basis:

Oil Level

The level in the reservoir should not be allowed to fall below a quarter full.

Chain and Bar

After every few hours of use, remove the guide bar and chain and clean thoroughly.

Saw Chain Sharpening

CAUTION: Sharp chain. Always wear protective gloves when handling the chain. The chain is sharp and can cut you when it is not running.

WARNING: Sharp moving chain. To prevent accidental operation, insure that battery is disconnected from the tool before performing the following operations. Failure to do this could result in serious personal injury.

To get the best possible performance from your chain saw it is important to keep the teeth of the chain sharp. Follow these helpful tips for proper saw chain sharpening:

1. For best results use a 4.5mm file and a file holder or filing guide to sharpen your chain. This will ensure you always get the correct sharpening angles.
2. Place the file holder flat on the top plate and depth gauge of the cutter.

3. **(Figure X)** Keep the correct top plate (24) filing angle line of 30° on your file guide parallel with your chain (file at 60° from chain viewed from above).

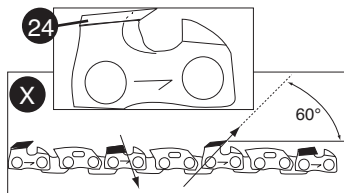

4. **(Figure Y)** Sharpen cutters (25) on one side of the chain first. File from the inside of each cutter to the outside. Then turn your saw around and repeat the processes (2,3,4) for cutters on the other side of the chain. Use a flat file to file the tops of the rakers (portion of chain link in front of the cutter) so that they are about .025 inch (.635 mm) below the tips of the cutters.

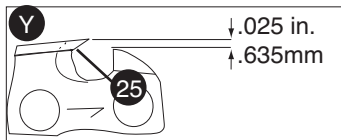

5. **(Figure Z)** Keep all cutter lengths equal.
6. If damage is present on the chrome surface of the top plates or side plates, file back until such damage is removed.

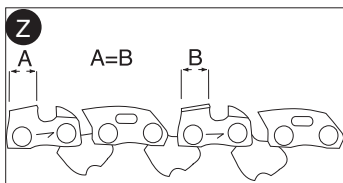

⚠ CAUTION: After filing, the cutter will be sharp, use extra caution during this process.

NOTE: Each time the chain is sharpened, it loses some of the low kickback qualities and extra caution should be used. It is recommended that a chain be sharpened no more than four times.

THE RBRC™ SEAL

The RBRC™ (Rechargeable Battery Recycling Corporation) Seal on the LI-ION battery (or battery pack) indicates that the costs to recycle the battery (or battery pack) at the end of its useful life have already been paid by **Black & Decker**.



RBRC™ in cooperation with **Black & Decker** and other battery users, has established programs in the United States to facilitate the collection of spent LI-ION batteries. Help protect our environment and conserve natural resources by returning the spent LI-ION battery to an authorized **Black & Decker** service center or to your local retailer for recycling. You may also contact your local recycling center for information on where to drop off the spent battery. RBRC™ is a registered trademark of the *Rechargeable Battery Recycling Corporation*.

ACCESSORIES

Accessories are available from your local retailer or nearest Black & Decker service center.

Replacement chain accessory number RC800 (service part # 623382-00)

Replacement bar service part # 623381-00

⚠ WARNING: The use of accessories not recommended in this manual may be hazardous.

SERVICE INFORMATION

All Black & Decker Service Centers are staffed with trained personnel to provide customers with efficient and reliable power tool service. Whether you need technical advice, repair, or genuine factory replacement parts, contact the Black & Decker location nearest you. To find your local service location, refer to the yellow page directory under "Tools—Electric" or call: **1-800-544-6986** or visit **www.blackanddecker.com**

FULL TWO-YEAR HOME USE WARRANTY

Black & Decker (U.S.) Inc. warrants this product for two years against any defects in material or workmanship. The defective product will be replaced or repaired at no charge in either of two ways.

The first, is to return the product to the retailer from whom it was purchased (provided that the store is a participating retailer). Returns should be made within the time period of the retailer's policy for exchanges (usually 30 to 90 days after the sale). Proof of purchase may be required. Please check with the retailer for their specific return policy regarding returns that are beyond the time set for exchanges.

The second option is to take or send the product (prepaid) to a Black & Decker owned or authorized Service Center for repair or replacement at our option. Proof of purchase may be required. Black & Decker owned and authorized Service Centers are listed under "Tools-Electric" in the yellow pages of the phone directory.

This warranty does not apply to accessories. This warranty gives you specific legal rights and you may have other rights which vary from state to state or province to province. Should you have any questions, contact the manager of your nearest Black & Decker Service Center. This product is not intended for commercial use.

LATIN AMERICA: This warranty does not apply to products sold in Latin America. For products sold in Latin America, check country specific warranty information contained in the packaging, call the local company or see the website for warranty information. **FREE**

WARNING LABEL REPLACEMENT: If your warning labels become illegible or are missing, call **1-800-544-6986** for a free replacement.

Imported by
Black & Decker (U.S.) Inc.,
701 E. Joppa Rd.
Towson, MD 21286 U.S.A.

See 'Tools-Electric'
– Yellow Pages –
for Service & Sales



BlackandDecker.com
1-800-544-6986

TROUBLESHOOTING

If your Chain Saw does not operate correctly check the following:

| Problem | Possible Cause | Possible Solution |
|--------------------------------|--|--|
| • Tool will not start. | • Battery not installed properly. • Battery not charged. • Lock-out button not actuated. | • Check battery installation. • Check battery charging requirements. • Push lock off button/actuate trigger. |
| • Unit will not charge. | • Battery not inserted into charger. | • Insert battery into charger until green LED appears. Charge up to 8 hours if battery totally drained. |
| • Bar / chain overheated. | • Chain too tight. • Lubrication needed. | • Refer to "adjusting chain tension" section. • Refer to "chain oiling" section. |
| • Chain is loose. | • Chain tension set incorrectly. | • Refer to "adjusting chain tension" section. |
| • Poor cut quality. | • Chain tension set incorrectly. • Chain needs replacement. | • Refer to "adjusting chain tension" section. Note: Excessive tension leads to excessive wear and reduction in life of bar & chain. Lubricate before each cut. Refer to "replacing the chain" section. |
| • Unit runs but does not cut. | • Chain installed backwards. | • Refer to sections for installing and removing chain. |
| • Oil is not getting to chain. | • Sawdust / debris is accumulated under sprocket cover. | • Remove battery, remove sprocket cover. Clean out accumulated sawdust / debris. |