

Miele

Operating Instructions



Freestanding coffee machine CM 5200

To prevent accidents
and machine damage
read these instructions

before
installation or use.

en - US

M.-Nr. 09 319 110

Contents

IMPORTANT SAFETY INSTRUCTIONS	4
Guide to the machine	8
Display and controls	9
Button illumination	10
Operation	10
Preparing the coffee machine for use	11
Before using for the first time	11
Turning on for the first time	11
Water hardness	12
Filling the water tank	14
Filling the coffee bean container	15
Turning the machine On / Off	16
Pre-heating cups	17
To switch cup heating on or off	17
Adjusting the coffee dispensers to the cup height	18
Canceling preparation	19
Espresso or coffee	20
Preparing espresso or coffee	20
Preparing two portions at one time	20
Making coffee or espresso using ground coffee	21
Adding ground coffee	21
Making coffee or espresso using ground coffee	22
Specialty coffees with milk	23
Preparation	23
Stainless steel milk flask	23
Preparing two portions at one time	24
After dispensing milk	25
Preparing hot water	26
Adjusting the grinder setting	27
Grinder setting	27
Adjusting the strength of the coffee	28
Amount of coffee	28
Pre-brewing the coffee	29
Brewing temperature	30
Setting the serving size	31

The SETTINGS menu	34
Possible setting options	35
Language	37
Time of day and clock display	37
Timer functions	38
Operating modes	41
To display information	42
To lock the coffee machine	42
Factory default	43
Demo mode	44
Cleaning and care	45
Quick guide	45
Rinsing the system	47
Rinsing the milk system	47
Cleaning the milk system	48
Cleaning the stainless steel milk flask	51
Water container	51
Drip tray cover	52
Drip tray and waste container	52
Bean container and ground coffee chute	54
Brew unit	54
Exterior	57
Descaling	58
Descaling following display reminder	58
Selecting Descale from the MAINTENANCE menu	59
Energy saving mode	60
Frequently asked questions	61
After sales service	71
Accessories	72
Transport	73
Evaporating the coffee machine	73
Packing	73
Installation instructions	75
Electrical connection	76
Installation	77
Dimensions	78
Caring for the environment	79

IMPORTANT SAFETY INSTRUCTIONS

When using electrical appliances basic safety precautions should always be followed, including the following:

Read all instructions before installation or use of the coffee system.

Please read these instructions carefully to prevent accidents and machine damage.

This appliance complies with current safety requirements. Improper use of the appliance can cause personal injury and material damage.

Read this safety information carefully before operating the appliance. They contain important information on the safe installation, operation, and care of your coffee system. To avoid the risk of personal injury or damage to the coffee system, it is important that you carefully read the instructions.

Keep these instructions in a safe place and pass the on to any future user.

Proper Use

► This coffee system is not designed for commercial use. It is intended for household use and only, for the preparation of coffee, cappuccino, espresso, etc.

Do not use appliance other than for its intended use. Any other use could be dangerous.

► This coffee machine is not intended for outdoor use.

► The coffee machine is intended for household use only for the preparation of coffee, cappuccino, espresso, latte macchiato, etc.

Any other use is not supported. Miele cannot be held liable for damage resulting from incorrect or improper use.

► Persons which lack physical, sensory or mental abilities or experience with the machine should not use it without supervision or instruction by a responsible person.

IMPORTANT SAFETY INSTRUCTIONS

Children

Caution! The coffee and hot water dispensers present a danger of burning or scalding!

Children's skin is very sensitive and reacts to hot temperatures.

- ▶ Keep the coffee system out of reach of children.
- ▶ Close supervision is necessary when the coffee machine is used near children.
- ▶ Never let children play with the coffee machine.

Technical safety

- ▶ Before installing the coffee machine, check for externally visible damage. If the coffee system is damaged, it may pose a safety hazard and must not be used under any circumstances.
- ▶ Before connecting the coffee machine, check the voltage and frequency indicated on the data plate against the voltage and frequency of the household electrical supply. The values must correspond in order to prevent damage to the coffee machine. If in doubt, consult a qualified electrician. To disconnect, turn the main switch at the back of the machine to 0, then remove the plug from the wall outlet.

- ▶ Be certain your appliance is properly installed and grounded by a qualified technician. To guarantee the electrical safety of this appliance, continuity must exist between the appliance and an effective grounding system. It is imperative that this basic safety requirement be met. If there is any doubt, have the electrical system of the house checked by a qualified electrician.
- ▶ Do not operate any appliance with a damaged cord or plug, or after the appliance malfunctions or has been damaged in any manner. Contact Miele.
- ▶ Unplug the machine from the power supply immediately if you notice any damage or smell scorching, for example.
- ▶ Ensure that the power cord will not be pinched or damaged by any sharp edges.
- ▶ Ensure that the power cord does not hang down. Someone could trip over it and the machine could be damaged.
- ▶ The coffee machine must not be used in mobile installations such as ships.
- ▶ The ambient temperature should be between 50°F (10°C) and 90°F (32°C).
- ▶ Ensure that there is sufficient ventilation around the coffee machine. Do not cover the vents on the top.

IMPORTANT SAFETY INSTRUCTIONS

▶ Do not place the appliance on or near a hot gas or electric burner, or in a heated oven.

▶ The use of accessory attachments not recommended by the appliance manufacturer may result in fire, electric shock or injury to persons.

▶ Protect the coffee machine from water and water spray.

▶ Installation, maintenance and repairs may only be carried out by qualified technicians.

▶ Repairs must only be performed by a trained technician in accordance with national and local safety regulations. Repairs and other work by unauthorized persons could be dangerous and may void the warranty.

▶ Defective components should be replaced by Miele original parts only. Only with original Miele parts can the manufacturer guarantee the safety of the appliance.

▶ Unplug from outlet when not in use and before cleaning and care. Allow to cool before putting on or taking off parts, and before cleaning the appliance.

▶ Never open the outer casing of the appliance. Tampering with electrical connections or components and mechanical parts is dangerous and may cause machine damage.

▶ To protect against fire, electric shock and injury to persons do not submerge the cord, plugs or coffee machine in water or other liquids.

▶ If the coffee system will not be used for an extended period of time, turn it off by using the main power switch.

Safety

Caution! The coffee and hot water dispensers present a danger of burning or scalding! The liquids and steam dispensed are very hot.

▶ Keep away from the areas under the coffee dispensers when beverages or steam are being dispensed.

▶ Do not touch hot components. Use handles or knobs.

▶ The spouts can spray hot liquid or steam. Be sure the cappuccinatore is fitted correctly and only use it if it is clean.

▶ Do not use the coffee machine to clean objects.

▶ Clean the coffee machine and the milk flask (depending on model) thoroughly before using for the first time. Before first use, flush the coffee and milk supply lines thoroughly (see "Cleaning and care").

▶ Only fill the water container with cold, fresh tap water. Warm or hot water and other liquids can damage the coffee machine.

▶ Change the water every day to prevent a build-up of bacteria.

▶ Do not use mineral water. Mineral water will cause serious limescale deposits to build up in your coffee machine and damage it.

IMPORTANT SAFETY INSTRUCTIONS

- ▶ Fill the bean container only with roasted whole coffee beans. Do not fill the bean container with coffee beans which have been treated or with ground coffee.
- ▶ Do not reach into the grinder.
- ▶ Only put ground coffee or cleaning tablets to the ground coffee chute. The cleaning tablets remove grease from the brew unit of the coffee machine.
- ▶ Only use plain milk. Flavored milk products contain substances that can clog the milk system.
- ▶ Do not use coffee beans which have been treated with caramel, sugar, or fill the coffee machine with other sugar-containing liquids. Sugar damages the machine!
- ▶ Never place a cup with a burning alcohol-coffee mixture underneath the main dispenser. This could cause plastic parts of the coffee machine to catch fire and melt.
- ▶ Do not place any open flame, e.g. a candle, on or near the coffee machine. The coffee machine could catch fire and the fire could spread.
- ▶ Disconnect the coffee machine from the power supply before cleaning.
- ▶ Clean the coffee machine and the milk flask (depending on model) daily (for further information see "Cleaning and Care").
- ▶ Do not use a steam cleaner to clean this machine. The steam could cause a short circuit.
- ▶ Descale the coffee machine regularly with the appropriate number of Miele descaling tablets for the water hardness level in your area. Descale the machine more frequently in areas with very hard water. The manufacturer cannot be held liable for damage arising from insufficient descaling.
- ▶ Degrease the brew unit regularly with the supplied Miele cleaning tablets. Depending on the natural oil content of the coffee used, the brew unit can become blocked quite quickly.
- ▶ Used coffee grounds from the waste container should be disposed of with organic waste or put on the compost heap. Coffee grounds can clog the sink.

For machines with stainless steel trim:

- ▶ Do not use sticky notes, transparent adhesive tape, masking tape or other types of adhesive on the surface of the trim. These damage the surface, causing it to lose its dirt repellent protective coating.
- ▶ The surface of the stainless steel trim is susceptible to scratching. Even magnets can cause scratches to appear.

SAVE THESE INSTRUCTIONS AND REVIEW THEM PERIODICALLY

Guide to the machine

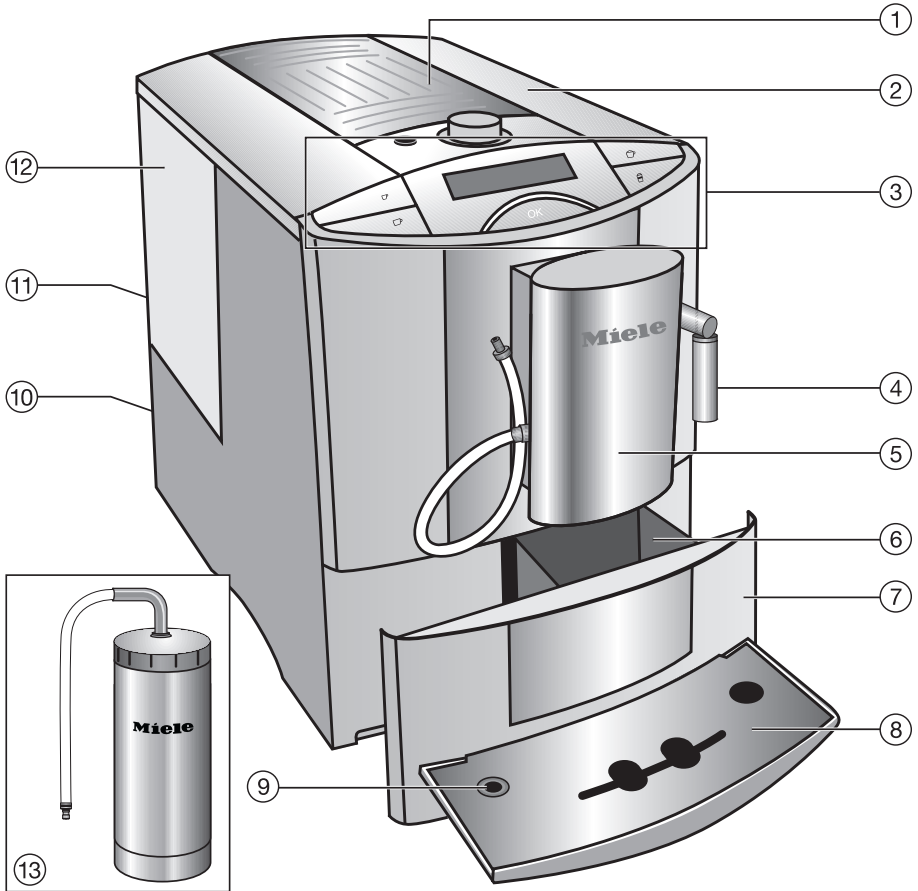

- ① Cup warming surface
- ② Bean container, ground coffee chute and rotary selector to control the fineness of the ground coffee
- ③ Display and controls
- ④ Hot water spout
- ⑤ Central spout with integrated cappuccinatore
- ⑥ Waste container
- ⑦ Drip tray
- ⑧ Drip tray cover
- ⑨ Milk tube aperture
- ⑩ Main switch
- ⑪ Compartment for quick guide
- ⑫ Water container
- ⑬ Milk container (depending on model)

Display and controls

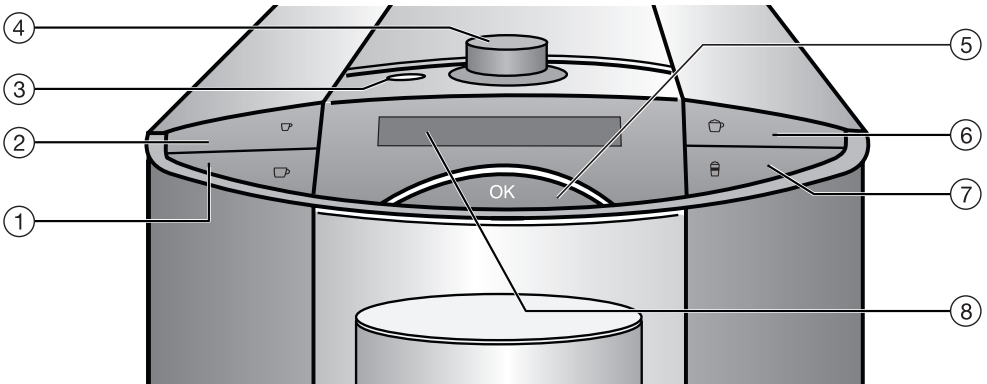

Drink buttons

Press these buttons to prepare the desired drink.

The symbols mean:

- ☐ Espresso ②
- ☐ Coffee ①
- ☐ Latte Macchiato ⑦
- ☐ Cappuccino ⑥

To **prepare a drink**, press the corresponding button once.

For **two portions of a drink**, press the corresponding button briefly twice in succession.

To **specify portion size** (programming amount), hold the drink button down for more than 3 seconds.

OK button ⑤

With the OK button you confirm display information and save settings.

Rotary selector ④

You can select from the different menu options using the rotary selector.

On/Off button ③

The On/Off button  turns the coffee machine on and off (Standby), if the main switch on the back is turned on.

Display ⑧

The display gives information about current action or status of the coffee machine.

Guide to the machine

Button illumination

When the drink buttons are illuminated, you are in the main menu and can prepare drinks. If drink preparation has commenced, only the corresponding drink button is illuminated.

The semicircle also lights up on the OK button shortly before the steam is produced, e.g. for milk froth.

The OK button and the semicircle are illuminated when a menu is called up, when an option selection is possible or if an action requires confirmation.

Operation

You are in the main menu when the display shows:



If ◀ and ▶ appear in the display, you can select further options using the rotary selector.

To select an action or setting

- Turn the rotary selector until the action or setting you want appears in the display.
Press the OK button.

You will be able to identify the current active setting by the checkmark ✓.

- To save a setting, press the OK button.

Calling up a menu

- You can call up menus by holding the OK button for more than 2 seconds

Using the rotary selector, you choose from

- OTHER DRINKS
- MAINTENANCE
- SETTINGS

- Press the OK button to confirm your selection.

You will be able to start actions or alter settings in the selected menu.

Exiting a menu level

- Turn the rotary selector until BACK appears in the display.
Press the OK button.

or

- Press the OK button for 2 seconds .

or

If none of the buttons has been pressed for a while, the coffee machine will revert to the main menu.

Preparing the coffee machine for use

Please read the operating instructions and take the time to familiarize yourself with the coffee machine before using it for the first time.

Before using for the first time

- Set up the coffee machine and remove any protective film (see "Installation").

Clean the coffee machine thoroughly (see "Cleaning and Care") before filling it with water and coffee beans.

- Insert the plug of the coffee machine into the outlet (see "Electrical connection").

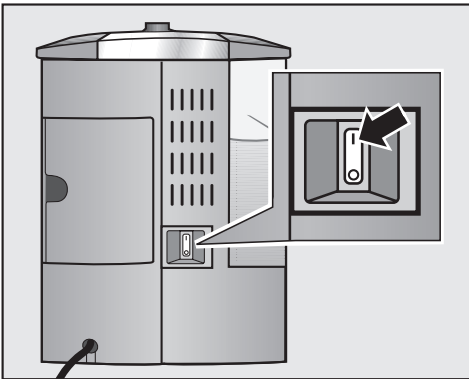

- Set the main switch at the back of the coffee machine to "I".

Turning on for the first time

When you turn the coffee machine on for the first time, you will be prompted to set the following after the welcome screen has appeared:

- Language
- Time format
- Time of day

- Press the On/Off button .

The welcome message MIELE - WILLKOMMEN will appear in the display briefly.

To set the language

- Turn the rotary selector until the language you require appears in the display.
Press the OK button.

The setting is now saved.

To set the time format

- Select 12 H, if you want the time to be shown as a 12 hour clock.

or

- Select 24 H, if you want the time to be shown as a 24 hour clock.

- Press the OK button.

The setting is now saved.

Preparing the coffee machine for use

To set the time of day

- Turn the rotary selector until the current hour appears in the display. Press the OK button.
- Turn the rotary selector until the current minutes appear in the display. Press the OK button.

The setting is now saved. SET UP SUCCESSFUL will now appear in the display.

- Press the OK button.

In the display you will see:



FILL WATER CONTAINER
AND PLACE IN MACHINE

- Fill the water container with cold, fresh tap water.

TIP Place a suitable container underneath the hot water spout.

In the display you will see:



< SYSTEM FILLING UP
START >

- Press the OK button.

TIP Continue following the instructions given in this booklet to set up your machine and familiarize yourself with it.

Water hardness

Water hardness is an indication of the amount of minerals dissolved in water. The higher the mineral content, the harder the water. And the harder the water, the more often the coffee machine will need to be descaled.

The coffee machine monitors the quantity of water and steam used. The number of drinks which can be dispensed before the machine needs to be descaled will depend on the water hardness level set.

Set the water hardness level on the coffee machine to the water hardness level for the local area to ensure that the machine functions correctly and is not damaged. This will ensure that the reminder to descale the machine will appear in the display at the correct time.

There is a choice of four water hardness levels:

- **Level 1 (soft):**
0 - 3 gr/gal (0 - 3 °dH)
- **Level 2 (moderate):**
4 - 7 gr/gal (4 - 7 °dH)
- **Level 3 (hard):**
7 - 15 gr/gal (7 - 14 °dH)
- **Level 4 (very hard):**
15 - 22 gr/gal (14 - 21 °dH)

Preparing the coffee machine for use

Determining the water hardness

You can test the water hardness with the supplied test strips. Your local water supplier will also be able to advise you on the water hardness in your area.

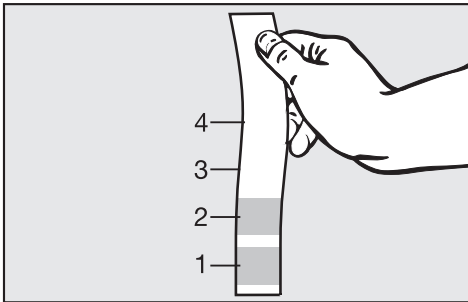

- Dip the test strip in water for a second, then shake off any excess water. The result will be visible after about one minute.

You can now set the water hardness level for the coffee machine.

Setting the water hardness level

SELECT TYPE OF DRINK will appear in the display.

- Press the OK button until MENU appears in the display.
- Turn the rotary selector until SETTINGS appears in the display. Press the OK button.



- Select WATER HARDNESS and press the OK button.
- Turn the rotary selector until the water hardness level you require appears in the display. Press the OK button.

The setting is now saved.

Filling the water tank

The quality of the water used plays an important part in the overall quality of the coffee.

The water tank should be emptied and filled with fresh, cold tap water.

Hot or warm water, or other liquids could damage the coffee system.

Do not use mineral water. Mineral water will cause lime scale deposits to build up in the machine, possibly damaging it.

- Open the lid on the left hand side of the coffee system ①. Pull the water tank up and out using the handle ②.

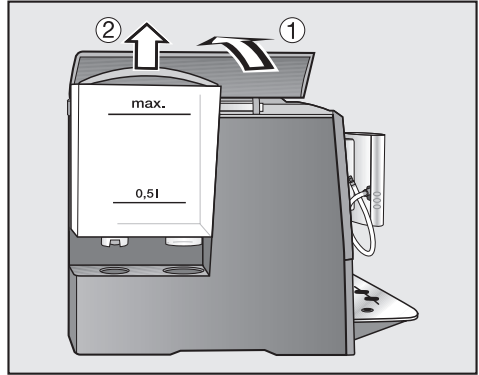

- Fill the water tank with fresh, cold tap water to the "Max." mark.

Be sure the area under the water tank is clean and free of obstructions. If the water tank is not seated correctly the drainage valve will not be sealed. Clean if necessary.

- Replace the water tank. Make sure the tank fits correctly onto the notch at the top of the housing.
- Close the lid.

Filling the coffee bean container

Fill the coffee bean container with roasted espresso or coffee beans.

Important: Only use roasted espresso or coffee beans in the container. Anything else, including ground coffee, will damage the grinder.

Important: Do not use coffee beans that have been treated with sugar, caramel or other substances. Do not put drinks containing sugar in the coffee bean container. Sugar will damage the machine.

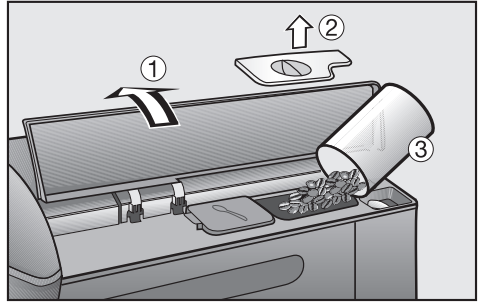

- Open the lid on the right of the coffee system ①. Remove the coffee bean container lid ②.
- Fill the container ③ with roasted coffee beans.
- Replace the bean container lid, close the coffee system lid.

TIP Only add enough beans to last for a few days. Contact with the air causes the beans to lose their flavor.

Turning the machine On / Off

The On/Off button  (Standby) can be used to turn the coffee system on or off, if the main switch at the back of the machine is turned on.

Turning on

When the machine is turned on, it heats up and rinses out the pipework. This cleans and heats the pipework ready for coffee preparation. After rinsing, hot water will run into the drip tray.

TIP If you do not want the water from the rinsing process to flow into the drip tray, place a suitable container underneath the coffee dispensers before preparing the first coffee of the day.

If the coffee machine still has an operating temperature higher than 140°F (60°C), rinsing will not take place.

- Press the On/Off button .

The following will appear in the display:

HEATING UP PHASE

The following appears in the display after heating up:

RINSING

Hot water will flow from the coffee dispensers.

The main menu will then appear in the display:

SELECT TYPE OF DRINK

You can now prepare drinks.

Turning off

- Press the On/Off button .

The coffee machine rinses the coffee pipework before turning off.

If you have made a drink with milk, the following message appears in the display:

RINSE THE MILK SYSTEM

- Press the OK button to rinse the milk system.
- Follow the instructions given in the display.

The milk system is rinsed out.

If the milk system is not rinsed before turning off, the message RINSE THE MILK SYSTEM or CLEAN THE MILK SYSTEM will appear in the display next time the machine is turned on.

Follow the instructions in the display next time the machine is turned on (see "Rinsing the milk system").

TIP To save energy, use the main switch at the back of the coffee machine to turn it off if it is not going to be used for a long period of time, e.g. during holidays.

Please note that the time of day will not be saved and must be entered again the next time the coffee machine is turned on.

Cups should always be pre-heated to allow the flavor of espresso and other coffee drinks to develop and be retained.

The smaller the volume of coffee/espresso and the thicker the cup, the more important it is to pre-heat the cup.

You can use the cup heating surface on the top of the coffee machine to pre-heat coffee cups and glasses. The cup heating function must be turned on.

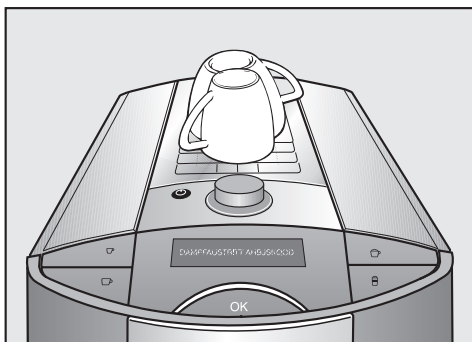

- Arrange the cups or glasses on the cup heating surface on the top of the coffee machine.

The cup heating surface will be heated continually until the coffee machine is turned off.

To switch cup heating on or off

SELECT TYPE OF DRINK will appear in the display.

- Press the OK button until MENU appears in the display.
- Turn the rotary selector until SETTINGS appears in the display. Press the OK button.



- Select CUP HEATING and press the OK button.
- To turn cup heating on, turn the rotary selector until YES appears in the display.

or

- To turn cup heating off, turn the rotary control until NO appears in the display.
- Press the OK button.

Adjusting the coffee dispensers to the cup height

The coffee dispensers can be raised or lowered to the height of your cup. If the dispensers are closer the beverage will not cool down as quickly and the crema will have a better consistency.

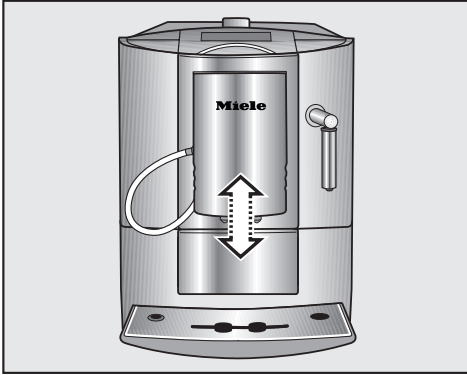

- Pull the coffee dispenser down to the same level as the rim of the cup.

or

- Push the dispenser up until there is enough room to fit a larger cup or mug underneath.

Canceling preparation

Preparation can be canceled while STOP is showing in the display.

To cancel the preparation of **coffee** or **espresso**,

- press the OK button.

Drink preparation will be canceled.

To cancel the preparation of **specialty coffees with milk** or **two portions of a drink**, you can cancel

- the preparation of the ingredients individually or
- the preparation of the entire drink.

To cancel an **individual** stage, e.g. milk froth,

- press the OK button once.

To cancel preparation of a **whole** drink,

- press the OK button twice.

or

- press and hold the OK button.

Drink preparation will be canceled.

TIP During the grinding and heating up phases, preparation of the whole drink can be canceled with **one** press of the button.

Espresso or coffee

Preparing espresso or coffee

When the ☐ or ☐ buttons are pressed, the coffee system automatically grinds the beans to brew the coffee.

SELECT TYPE OF DRINK will appear in the display.

- Place a cup under the coffee dispensers.



- To make an espresso press the ☐ button.

or

- To make a coffee press the ☐ button.

The chosen beverage will now be dispensed.

To ensure that any residues from the factory testing process are removed from the brewing system, please discard the first two cups of coffee when using the machine for the first time.

Preparing two portions at one time

You can request two portions of espresso or coffee at once in one cup or in two separate cups simultaneously.

To prepare two cups of coffee or espresso at the same time:



- Place a cup under each coffee dispenser.
- Press the button for the desired drink twice.

Two portions of the desired drink will be dispensed from the coffee dispensers.

Making coffee or espresso using ground coffee

To make espresso or coffee using ready ground coffee, add a portion of ground coffee to the ground coffee chute.

This allows you to prepare a decaffeinated coffee, if the bean container is already filled with regular coffee beans for example.

The coffee machine will automatically recognize that ground coffee has been placed in the chute.

Only **one** portion can be prepared at a time when using ready ground coffee.

Adding ground coffee

Use the scoop supplied with the machine to ensure the correct amount of ground coffee is used.

Do not add more than one level scoop of ground coffee to the coffee chute. If too much ground coffee is added to the ground coffee chute the brew unit cannot process it.

The coffee machine uses all the coffee powder which is put in to dispense the next drink.

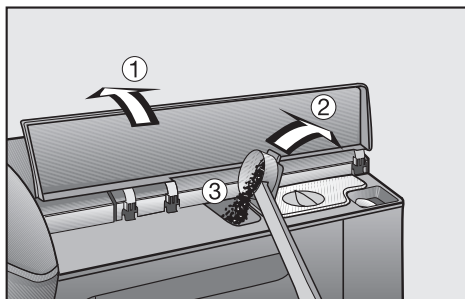

- Open the lid on the right hand side of the coffee machine ①.
- Open the lid of the ground coffee chute ②. Add one level scoop of ready ground coffee into the ground coffee chute ③.
- Close both lids.

The following message appears in the display:



- To prepare the coffee/espresso using ground coffee, confirm with the OK button.

or to **cancel** preparation with ground coffee:

- Turn the rotary selector until NO appears in the display.
- Press the OK button.

The ground coffee will be directed into the waste container.

Making coffee or espresso using ground coffee

Making coffee or espresso using ground coffee

You can now select whether you want to dispense a coffee or an espresso made with ground coffee.

If no button is pressed within approx. 15 seconds, the ground coffee is emptied into the waste container.

The following message appears in the display:



SELECT DRINK
USE GROUND COFFEE

- Place a cup under the coffee dispensers.
- To make an espresso press the ☒ button.

or

- To make a coffee press the ☒ button.

The desired coffee drink is prepared.

Specialty coffees with milk

You can choose from a variety of specialty coffees. with milk

Cappuccino consists of about two-thirds milk froth and one-third espresso.

Latte macchiato consists of one-third each of hot milk, milk froth and espresso.

Caffè latte consists of hot milk and coffee.

Hot milk or **milk** froth can also be prepared just as easily.

TIP For best results use cold milk for making milk froth.

Preparation

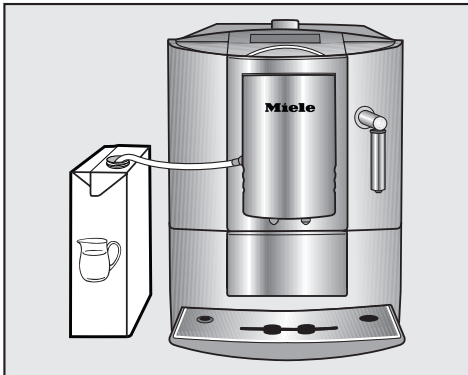

- Place a container with sufficient milk beside the coffee machine on the left hand side.
- Insert the milk tube into the container. Make sure that the milk tube is sufficiently submerged in the milk.

Stainless steel milk flask

(depending on the model)

The stainless steel milk container helps keep the milk cold for longer. Cold milk gives best results for milk froth.



- Connect the stainless steel suction tube to the inside of the lid. Make sure that the slanted end is pointing downwards, as shown.
- Fill the flask with milk up to a maximum of 3/4" (2 cm) below the rim. Place the lid on the flask.
- Connect the stainless steel angled end of the milk tube to the top of the lid until it clicks into place.
- Place the milk flask on the left hand side of the coffee machine. Connect the other end of the milk tube to the cappuccinatore.

Specialty coffees with milk

Making specialty coffees with milk

Caution! Danger of burning and scalding from hot steam coming out of the cappuccinatore. The liquids and steam dispensed are very hot.

The coffee machine heats up when a button is pressed to request a drink. HEATING-UP PHASE will appear in the display.

Steam is then used to heat the milk in the cappuccinatore. It can also be frothed if milk froth is required.

If you have not prepared any milk drinks for some time, rinse the milk system before preparing the first drink. This will remove any bacteria which may have built up in the milk tube.

Cappuccino or latte macchiato

Use a cup for cappuccino or a glass for latte macchiato.

SELECT TYPE OF DRINK will appear in the display.

■ Place a suitable container under the coffee dispensers.

■ To make an espresso press the ☕ button.

or

■ To make a latte macchiato press the ☕ button.

The desired coffee drink is prepared.

Caffè latte, milk froth or hot milk

SELECT TYPE OF DRINK will appear in the display.

■ Place a suitable container under the coffee dispensers.

■ Press the OK button until MENU appears in the display.



■ Turn the rotary selector until OTHER DRINKS appears in the display. Press the OK button.

■ Use the rotary selector to select the drink you want:

– CAFFÈ LATTE

– MILK FROTH

– HOT MILK

■ Press the OK button.

The desired coffee drink is prepared.

Preparing two portions at one time

You can select two portions of **cappuccino** or **latte macchiato** at the same time.

■ Place a suitable container under each coffee dispenser.

■ Press the button twice for your choice of cappuccino ☕ or latte macchiato ☕.

The drinks will be dispensed.

Specialty coffees using ground coffee

You can also make cappuccino, latte macchiato or caffè latte from ground coffee.

- Fill the ground coffee chute with ground coffee (see "Espresso or coffee from ground coffee").

When SELECT TYPE OF DRINK USE GROUND COFFEE appears in the display,

- you can make **cappuccino** or **latte macchiato** at the touch of a button.

For **caffè latte** from ground coffee:

- Press the OK button to call up the OTHER DRINKS menu and then prepare caffè latte as described above.

After dispensing milk

Warning! Bacteria can cause infection.

It is important to clean and rinse the milk system regularly to avoid the risk of bacteria building up.

The milk system should be rinsed if more than an hour has elapsed since the last preparation of a milk drink (see "Rinsing the milk system") . If not done, the milk system can become clogged with milk residues.

Preparing hot water

You can make hot drinks or preheat cups using the hot water function.

Caution! Danger of scalding and burns. The water dispensed is very hot.

SELECT TYPE OF DRINK will appear in the display.



To stop dispensing water,

- press the OK button.

Drink preparation will be canceled.

- Place a suitable container under the hot water spout.
- Press the OK button until MENU appears in the display.
- Turn the rotary selector until OTHER DRINKS appears in the display. Press the OK button.
- Select HOT WATER with the rotary control. Press the OK button.

Hot water is dispensed into the container under the spout.

Adjusting the grinder setting

You can customize the coffee machine to suit the type of coffee used.

You can:

- adjust the grinder setting,
- change the amount of coffee,
- pre-brew the freshly ground coffee, and
- set the brewing temperature.

Grinder setting

You can adjust the grinder setting to suit the type of coffee you are using

When the beans are ground correctly the coffee or espresso will flow evenly into the cup and have a good crema.

The ideal crema has a hazelnut-brown color.

There are various ways to tell whether the coffee grinder is set correctly.

The coffee is ground **too coarse**, if

- espresso or coffee flows into the cup too quickly.
- the crema is very pale and uneven.

Set a finer grinder setting.

The coffee is ground **too fine**, if



- espresso or coffee flows into the cup very slowly.
- the crema is dark brown.

Set a coarser grinder setting.

To avoid damaging the grinder:

only ever adjust the grinder by one setting at a time.

Grind the coffee beans again if you want to adjust the grinder to the next setting.

- Place a suitable container under the coffee dispensers.
- Open the lid on the right hand side of the coffee machine.
- Press the  or the  button.

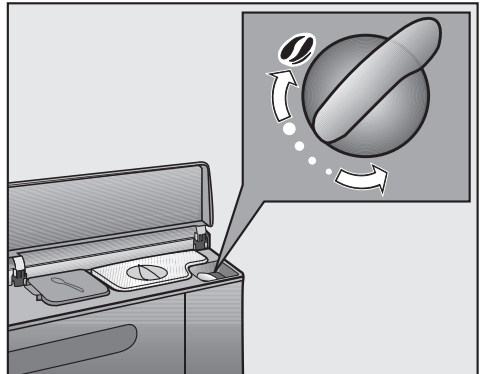

- Turn the grinder control counter-clockwise, if you want the beans to be ground more finely.
- or
- Turn the rotary selector for the grinder setting clockwise, if you want the beans to be ground more coarsely.

Adjusting the strength of the coffee

Amount of coffee

The coffee machine can grind and brew 6-14 g of coffee per cup. The greater the quantity, the stronger the coffee or espresso.

There are various ways to tell whether the amount of coffee is set correctly.

The amount of coffee is **too low**, if

- espresso or coffee flows into the cup too quickly.
- the crema is very pale and uneven.
- the espresso or coffee lacks body.

Increase the amount of coffee so that more ground coffee is brewed.

The amount of coffee is **too high**, if

- espresso or coffee flows into the cup very slowly.
- the crema is dark brown.
- the espresso or coffee tastes bitter.

Decrease the amount of coffee so that less ground coffee is brewed.

You can alter the amount of coffee by selecting a different setting. There is a choice of three settings.

- mild
- normal
- strong

You can alter the amount of coffee for espresso, coffee, cappuccino, latte macchiato and caffè latte individually.

SELECT TYPE OF DRINK will appear in the display.

■ Press the OK button until MENU appears in the display.

■ Turn the rotary selector until SETTINGS appears in the display. Press the OK button.



■ Select AMOUNT OF COFFEE and press the OK button.

■ Use the rotary selector to select the drink for which you want to set the coffee amount.

■ Turn the rotary selector until the setting you want appears in the display. Press the OK button.

The setting is now saved.

Pre-brewing the coffee

When the pre-brewing function is switched on, the freshly ground coffee is first moistened with a little hot water. Then the remaining water is forced through the moistened coffee at high pressure. This helps release the flavor of the coffee.

The pre-brewing function can be turned on or off. The machine is delivered with pre-brewing switched off.

SELECT TYPE OF DRINK will appear in the display.

- Press the OK button until MENU appears in the display.
- Turn the rotary selector until SETTINGS appears in the display. Press the OK button.



- Select PRE-BREWING and press the OK button.
- To turn pre-brewing on, turn the rotary selector until YES appears in the display.

or

- To turn pre-brewing off, turn the rotary selector until NO appears in the display.
- Press the OK button.

The setting is now saved.

Brewing temperature

Brewing temperature

The ideal brewing temperature depends on the type of coffee, and whether espresso or coffee is being prepared.

You can set different temperatures for espresso and coffee. There is a choice of three brewing temperatures:

- low
- normal
- high

TIP Not all types of coffee can withstand a high temperature. Certain types are too delicate - the crema on top would not be as good and the taste would be impaired.

SELECT TYPE OF DRINK will appear in the display.

- Press the OK button until MENU appears in the display.
- Turn the rotary selector until SETTINGS appears in the display. Press the OK button.



- Select TEMPERATURE and press the OK button.
- Use the rotary selector to select the drink for which you want to set the brew temperature
- Turn the rotary selector until the brew temperature you want appears in the display. Press the OK button.

The setting is now saved.

Setting the serving size

The coffee machine is equipped with portion programming. You can program the amount of water used for each portion of espresso, coffee or hot water to suit your taste and cup size.

For drinks prepared with milk, you can also set the duration of the steam used for heating or frothing the milk. You can also program the amount of hot milk and froth.

There is a maximum amount which can be programmed for each type of drink. Preparation stops when this is reached. The maximum portion size possible for that type of drink will then be saved.

There are two ways to program the portion amount; either:

- when preparing a drink, or
- if you call up PROG. THE AMOUNT in the SETTINGS menu.

If there is insufficient water in the water container, the process will be stopped. The portion size will **not** be saved.

TIP You can cancel programming the amount as long as CANCEL is visible in the display.

Setting the serving size when making a drink

Press the ☐, ☐, ☐ or ☐ button for at least 3 seconds to program the amount for that particular drink.

For caffè latte, milk froth, hot milk and hot water you can start portion size programming by pressing the OK button for at least 3 seconds after selecting the drink

Setting portion size for espresso and coffee

- Place the desired cup under the main dispenser.
- Press and hold the ☐ or ☐ button until PROG. THE AMOUNT appears in the display.



The selected drink will be prepared and SAVE will appear in the display.

- Press the OK button when the cup has been filled to the level you want.

The portion size programmed will now be dispensed every time that particular drink is selected.

Setting the serving size

Setting portion size for cappuccino and latte macchiato

- Place the desired cup under the main dispenser.
- Press the  or  button for at least 3 seconds.

The ingredients of the drink are now displayed and their respective quantities can be changed.

Cappuccino: milk froth, espresso

Latte macchiato: hot milk, milk froth, espresso

- Using the rotary selector select all ingredients for which you wish to alter the portion size. Confirm your selection by pressing the OK button.

You can see from the check  next to the relevant ingredient that portion size can be set for this.

- Turn the rotary selector until START appears in the display. Press the OK button.

The coffee machine starts making the drink. When SAVE appears in the display, portion sizes can be set for each selected ingredient.

- Press the OK button when the cup has been filled to the level you want.
- Save the portion size required for selected ingredients.

The portion size and ingredients programmed will now be dispensed every time that particular drink is selected.

Setting portion size for caffè latte, milk froth, hot milk and hot water

SELECT TYPE OF DRINK will appear in the display.

- Place a suitable container under the main dispenser.
- Press the OK button until MENU appears in the display.
- Turn the rotary selector until OTHER DRINKS appears in the display. Press the OK button.
- Use the rotary selector to select the program you want.
- Press the OK button until PROG. THE AMOUNT appears in the display.

For **Caffè latte** the quantities for individual ingredients – hot milk, coffee – can be altered as described in "Setting portion size for cappuccino and latte macchiato".

For **milk froth, hot milk and hot water**, proceed as described in "Setting portion size for espresso and coffee".

Setting the serving size from the SETTINGS menu

SELECT TYPE OF DRINK will appear in the display.

- Press the OK button until MENU appears in the display.
- Turn the rotary selector until SETTINGS appears in the display. Press the OK button.



- Select PROG. THE AMOUNT and press the OK button.
- Use the rotary selector to select the drink for which you want to set the portion size.
- Turn the rotary selector until START appears in the display. Press the OK button.

From now on the drink will be prepared according to the portion sizes set.

The SETTINGS menu

You can use the SETTINGS menu to customize the coffee machine to suit your personal requirements.

Calling up the SETTINGS menu

- Press the OK button for 2 seconds.



- Turn the rotary selector until SETTINGS appears in the display.
- Press the OK button.

Now you can adjust the settings, display information or check current settings.

Options which are currently selected will have a check  next to them.

TIP If the coffee machine is turned off at the On/Off  switch, you can also call up the SETTINGS menu in Standby. Press the OK button for 2 seconds to do so.

Possible setting options

The factory setting for the currently selected option is shown in **bold**.

Option	Available settings
Language	English, German and other languages
Time of day (available in Comfort mode)	Time format 12 H/ 24 H Set
Timer (available in Comfort mode)	Set switch on at / switch off after (1:00) / switch off at Activate Switch on at (yes / no) / switch off at (yes / no)
Program the amount	Espresso Coffee Cappuccino Latte Macchiato Caffè Latte Milk froth Hot Milk Hot water
Amount of coffee	Espresso mild / normal / strong Coffee mild / normal / strong Cappuccino mild / normal / strong Latte Macchiato mild / normal / strong Caffè Latte mild / normal / strong
Pre-brewing	Yes / No
Temperature	Espresso low / normal / high Coffee low / normal / high Cappuccino low / normal / high Latte Macchiato low / normal / high Caffè Latte low / normal / high
Operating mode	Eco mode Comfort mode

The SETTINGS menu

Option	Available settings
Info	Total portions Coffee drinks Espresso Coffee Cappuccino Latte Macchiato Caffè Latte Milk froth Hot Milk Hot water No. portions until descaling
Water hardness	Soft 1 Medium 2 Hard 3 Very hard 4
System lock	Yes / No
Cup heating	Yes / No
Demo mode (only available in Standby)	Yes / No
Factory default	Reset

Language

SELECT TYPE OF DRINK will appear in the display.

- Press the OK button until MENU appears in the display.
- Turn the rotary selector until SETTINGS appears in the display. Press the OK button.



- Select LANGUAGE  and press the OK button.
- Select the desired language and confirm with the OK button.

The setting is now saved and the display will revert to the previous screen.

The display will now appear in the language you have set.

If you select the wrong language by mistake, find the LANGUAGE option via the flag symbol  again.

Time of day and clock display

If you are operating the coffee machine in Comfort mode you can set the time of day and the time format in the clock display in the SETTINGS menu.

The clock can be displayed as:

- 24 hour clock
- 12 hour clock

The time of day has to be set for the timer to work, however it will **not** be visible in the display.

You will need to reset the time of day if there is a power cut or you switch the coffee machine off with the main switch.

SELECT TYPE OF DRINK will appear in the display.

- Press the OK button until MENU appears in the display.
- Turn the rotary selector until SETTINGS appears in the display. Press the OK button.



- Select TIME OF DAY and press the OK button.

You can now set the clock display and the time of day:

To set the clock display

- Select CLOCK DISPLAY and press the OK button.

The SETTINGS menu

- Select 24 H, if you want the time to be shown as a 24 hour clock.

or

- Select 12 H, if you want the time to be shown as a 12 hour clock.
- Press the OK button.

The setting is now saved.

To set the time of day

- Select SET and press the OK button.
- Turn the rotary selector until the current hour appears in the display. Press the OK button.
- Turn the rotary selector until the current minutes appear in the display. Press the OK button.

The setting is now saved.

Timer functions

The timer is only available if you are operating the coffee machine in **Comfort mode**.

You can set the timer so that the coffee machine:

- turns on at a particular time, e.g. in the morning for breakfast (SWITCH ON AT).
- turns off at a particular time (SWITCH OFF AT).
- turns off after a particular length of time if none of the buttons have been pressed and no drinks have been prepared (SWITCH OFF AFTER).

The timer will only work correctly if:

- the time of day has been set correctly,
- the coffee machine was turned off using the ON / Off button .

For "Switch on at" and "Switch off at", the timer must be activated.

With "**Switch off at**" and "**Switch off after**", remember: the milk system is not automatically rinsed out if a milk drink is prepared.

Follow the instructions in the display next time you switch on (see "Rinsing the milk system").

Setting the timer

SELECT TYPE OF DRINK will appear in the display.

- Press the OK button until MENU appears in the display.
- Turn the rotary selector until SETTINGS appears in the display. Press the OK button.



- Select TIMER and press the OK button.
- Turn the rotary selector until SET appears in the display. Press the OK button.

You can now choose the timer function you want to set.

Switch on at

Please note that the coffee machine will **not** switch on at the required time if you have activated the system lock.

- Select SWITCH ON AT and press the OK button.

You can now enter the hours and minutes.

- Turn the rotary selector until the hour you want appears in the display. Press the OK button.
- Turn the rotary selector until the minutes you want appears in the display. Press the OK button.

The setting is now saved.

The timer function must be **activated** for the coffee machine to switch on at the desired time (see "To activate and deactivate the timer").

If the coffee machine has turned itself on automatically 3 times and no drinks have been dispensed, the machine will not turn itself on again automatically. This prevents the coffee machine from turning itself on unnecessarily, for example while you are away on holiday.

The programmed times will, however, remain in memory and will be reactivated after manually turning the machine on again.

Switch off at

- Select SWITCH OFF AT and press the OK button.

You can now enter the hours and minutes.

- Turn the rotary selector until the hour you want appears in the display. Press the OK button.
- Turn the rotary selector until the minutes you want appears in the display. Press the OK button.

The setting is now saved.

The timer function must be **activated** for the coffee machine to switch off at the desired time (see "To activate and deactivate the timer").

The SETTINGS menu

Switch off after

If none of the buttons has been pressed or no drink has been prepared, the coffee machine will turn itself off after one hour to save energy.

You can change this timer function setting for "Switch off after" to another time between 15 minutes and 9 hours.

- Select SWITCH OFF AFTER and press the OK button.

You can now enter the hours and minutes.

- Turn the rotary selector until the hour you want appears in the display. Press the OK button.
- Turn the rotary selector until the minutes you want appears in the display. Press the OK button.

The setting is now saved. The coffee machine will now turn itself off after the set time.

To activate and deactivate the timer

If you have activated the "Switch on at" option for the timer,  will appear in the display when the coffee machine is in Standby mode.

Proceed as follows:

SELECT TYPE OF DRINK will appear in the display.

- Press the OK button until MENU appears in the display.
- Turn the rotary selector until SETTINGS appears in the display. Press the OK button.
- Select TIMER and press the OK button.



- Turn the rotary selector until ACTIVATE appears in the display. Press the OK button.
- Select SWITCH ON AT to activate or deactivate this timer function.

or

- Select SWITCH OFF AT to activate or deactivate this timer function.
- Press the OK button.

The setting is now saved.

Operating modes

You can operate the coffee machine in **Eco mode** or in **Comfort mode**.

The **Eco mode** is an energy-saving mode. The coffee machine will switch to energy saving mode if it has not been used to prepare a drink for some time. The coffee machine will heat up again when a button is pressed. The "Switch on at" and "Switch off at" timer functions are not available in Eco mode.

In **Comfort mode** the coffee machine will remain heated and all functions are available without restriction. The amount of energy used in Comfort mode is considerably higher than that used in Eco mode.

When the coffee machine is operated in Eco mode, the following will appear in the display while the machine is heating up:



The coffee machine is delivered with Eco mode preset.

To select the operating mode

SELECT TYPE OF DRINK will appear in the display.

- Press the OK button until MENU appears in the display.
- Turn the rotary selector until SETTINGS appears in the display. Press the OK button.



- Select OPERATING MODE and press the OK button.
- Select ECO MODE to operate the coffee machine in energy-saving mode.

or

- Select COMFORT MODE to operate the coffee machine in Comfort mode.
- Press the OK button.

The setting is now saved.

The SETTINGS menu

To display information

In the menu option INFO the number of portions prepared for each individual drink can be displayed.

You can also see whether more than 50 portions can be dispensed before the machine needs to be descaled (NO. PORTIONS UNTIL DESCALING).

SELECT TYPE OF DRINK will appear in the display.

- Press the OK button until MENU appears in the display.
- Turn the rotary selector until SETTINGS appears in the display. Press the OK button.



- Select INFO and press the OK button.
- Turn the rotary selector until the information you want appears in the display.

To return to the previous menu,

- press the OK button.

To lock the coffee machine

You can lock the coffee machine to prevent it being used without your knowledge, by children, for example.

To activate and deactivate the system lock

When the system lock is activated, the "Switch on at" option for the timer will not work. The timer symbol  will not appear in the display.

SELECT TYPE OF DRINK will appear in the display.

- Press the OK button until MENU appears in the display.
- Turn the rotary selector until SETTINGS appears in the display. Press the OK button.

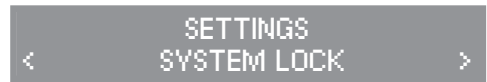

- Select SYSTEM LOCK and press the OK button.
- Select ON, to activate the system lock.

or

- Select OFF, to deactivate the system lock.
- Press the OK button.

The setting is now saved.

When the coffee machine is switched off it is locked and drinks cannot be dispensed.

To deactivate the system lock temporarily

You can deactivate the system lock temporarily, if you want to prepare drinks, for example.

- Press the OK button for 3 seconds .

You can now prepare drinks.

As soon as you turn the coffee machine off, the system lock will be activated again and the coffee machine is locked again.

Factory default

You can restore the settings back to the ones which were set when the coffee machine was delivered - the factory default settings.

Please refer to the "Possible setting options" chart for the factory settings which are shown in bold.

Please note that the following settings will **not** be reset:

- Language
- Time of day
- Number of drinks dispensed

SELECT TYPE OF DRINK will appear in the display.

- Press the OK button until MENU appears in the display.
- Turn the rotary selector until SETTINGS appears in the display. Press the OK button.



- Select FACTORY DEFAULT and press the OK button.
- Turn the rotary selector until RESTORE appears in the display. Press the OK button.

The settings are then reset to the default.

The SETTINGS menu

Demo mode

Do not activate this setting for domestic use.

The coffee machine can be demonstrated in the showroom or at exhibitions in "demo mode". In this mode the machine lights up, but no drinks are prepared or actions carried out.

To activate demo mode

The coffee machine cannot be switched off with the On/Off button  when demo mode is activated.

- Press the On/Off button  to turn off the machine (Standby).
- Press the OK button to call up MENU.
- Select SETTINGS and press the OK button.
- Select DEMO MODE and press the OK button.
- Turn the rotary selector until YES appears in the display. Press the OK button.

The following will appear in the display:

DEMO MODE
FOR SHOWROOMS ONLY

- Press the OK button.

- Follow the instructions given in the display.
- Confirm the messages DEMO MODE ACTIVE and MACHINE HEATING DEACTIVATED with the OK button.

Demo mode is active.

To deactivate demo mode

- Turn the coffee machine off with the main switch. Wait a short while and then turn the machine on again.
- Press the OK button to call up MENU.
- Select SETTINGS and press the OK button.
- Select DEMO MODE and press the OK button.
- Turn the rotary selector until NO appears in the display. Press the OK button.

The following will appear in the display:

DEMO MODE ACTIVE
FOR SHOWROOMS ONLY

- Press the OK button.
- Follow the instructions given in the display.
- Confirm the messages DEMO MODE DEACTIVATED and MACHINE HEATING ACTIVATED with the OK button.

The showroom demo program has now been deactivated.

Quick guide

The coffee system must be cleaned regularly to prevent a build-up of bacteria.

Recommended frequency	What do I have to do?
Each time milk is prepared, if more than one hour has passed since the last time milk was prepared	Rinsing the milk system
Daily (before you turn the coffee machine off)	Clean the water container
	Clean the waste container
	Clean the drip tray and the drip tray cover
	Clean the stainless steel milk flask (depending on the model)
Once a week	Cleaning the milk system
	Remove the brew unit and wash by hand
Approx. every 200 portions	Degrease the brew unit (with cleaning tablets)
When prompted	Descalc the coffee machine
When necessary	Clean the coffee bean container
	Clean the exterior (especially right after descaling)

Some components of the coffee machine are dishwasher safe. Cleaning these in the dishwasher frequently can however cause them to become discolored due to regular contact with food residues (e.g. tomatoes) in the dishwasher. The surface can also become damaged.

Clean by hand only	Dishwasher-safe
<ul style="list-style-type: none"> – Brew unit – Drip tray – Coffee bean container lid – Stainless steel milk flask (depending on the model) 	<ul style="list-style-type: none"> – Waste container – Drip tray cover – Water container – Integrated cappuccinatore with milk tube

Cleaning and care

Danger of burning and scalding on hot components or by hot liquids! Always allow the coffee machine to cool down before cleaning. Note that the water in the drip tray can be very hot.

Do not use a steam cleaner to clean the coffee machine. The steam could cause a short circuit.

To avoid damage to the surface do not use the following:

- cleaning agents containing soda, ammonia, acid or chloride,
- Solvent-based cleansers
- limescale removers,
- stainless steel cleaners,
- dishwasher detergent,
- oven cleaner,
- abrasive cleaning agents, e.g. powder or cream cleansers, pumice stones,
- scouring pads, such as pot scrubbers and sponges, or used sponges that still contain abrasive cleanser residue,
- eraser sponges,
- sharp metal scrapers,

In the MAINTENANCE menu you can call up the different care programs and change care settings.

Calling up the MAINTENANCE menu

- Press the OK button for more than 2 seconds.



- Turn the rotary selector until MAINTENANCE appears in the display.

- Press the OK button.

TIP If the coffee machine is turned off at the On/Off  switch, you can also call up the MAINTENANCE menu in Standby. Press the OK button for more than 2 seconds to do so.

Rinsing the system

The coffee machine rinses itself when it is turned on. This means that the pipes are pre-heated with warm water ready for you to prepare a delicious coffee drink immediately.

If a coffee drink has been prepared, the coffee machine also rinses itself before turning off. This removes any remaining coffee residue.

Rinsing the system manually

SELECT TYPE OF DRINK will appear in the display.

- Press the OK button until MENU appears in the display.
- Turn the rotary selector until MAINTENANCE appears in the display.
Press the OK button.
- Select RINSE THE SYSTEM and press the OK button.

The following will appear in the display:



- Press the OK button.

The piping will now be rinsed through. The water used for the rinsing process will run out of the coffee dispensers.

Rinsing the milk system

Caution! Bacteria can cause infection.

It is important to rinse the milk system regularly to avoid the risk of bacteria building up.

The milk system consists of the integrated cappuccinatore in the coffee dispensers and the milk tube.

You should **rinse the milk system** after every milk drink preparation, or at least if more than an hour elapses between preparation of milk drinks. Milk residue can clog up the milk pipes.

Rinsing does not replace **cleaning of the milk system**.

If milk has been prepared, the coffee machine reminds you to rinse the milk system on turning off.

TIP Place a suitable container underneath the coffee dispensers.

SELECT TYPE OF DRINK will appear in the display.

- Press the OK button until MENU appears in the display.
- Turn the rotary selector until MAINTENANCE appears in the display.
Press the OK button.
- Select RINSE MILK SYSTEM and press the OK button.

Cleaning and care

The following will appear in the display:

RINSING THE MILK SYSTEM
START

- Press the OK button.

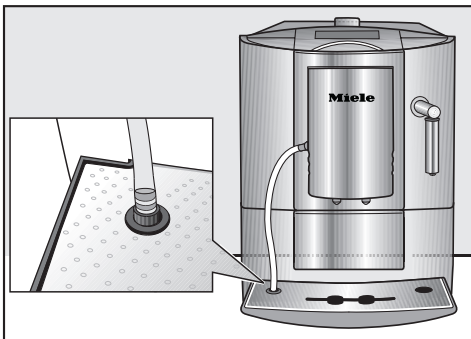

- Place the milk tube into the left-hand opening in the drip tray, when instructed in the display.
- Press the OK button.

The milk system is rinsed out.

Cleaning the milk system

Caution! Bacteria can cause infection.

It is important to clean the milk system regularly to avoid the risk of bacteria building up.

There are two options:

- You can remove and dismantle the integrated cappuccinatore and either wash it in the dishwasher or by hand with hot water and liquid dish soap
- or clean the milk system with the CLEAN THE MILK SYSTEM program and Miele cleaner.

The coffee machine will remind you to clean the milk system at the correct time.

The following will appear in the display:

CLEAN THE
MILK SYSTEM

- Press the OK button.

When you confirm the message CLEAN THE MILK SYSTEM with the OK button, the internal cleaning interval counter is reset. You will **not** be reminded again.

- Clean the milk system.

Dismantling and cleaning the milk system

The milk system can be cleaned in the dishwasher or by hand using hot water and liquid dish soap.

Place the individual components in the dishwasher for thorough cleaning.

- Pull the coffee dispensers all the way down.

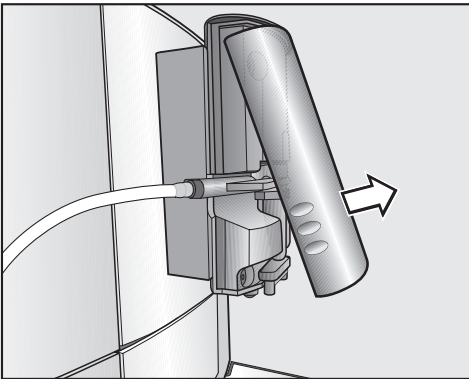

- Lift the cover forward and off.

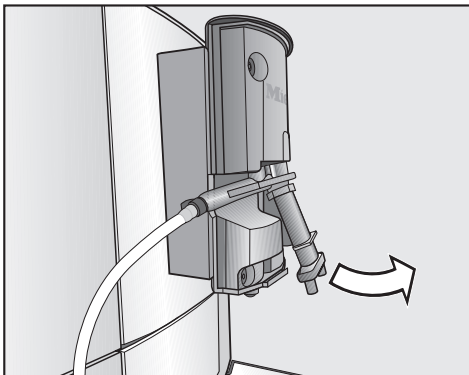

- Pull the integrated cappuccinatore down and remove it.

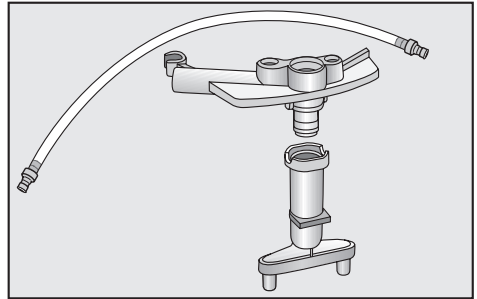

- Dismantle the integrated cappuccinatore. Clean all components thoroughly.

If the milk tube is blocked, clean under running water with the brush supplied.

- Insert the brush into the milk tube and move it back and forth until there are no more milk residues in the tube.

Cleaning and care

Now re-assemble the cappuccinatore:

- Reassemble the integrated cappuccinatore.

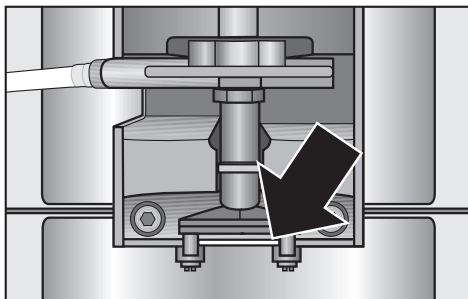

- Push the integrated cappuccinatore into the central spout. Push hard until the dispensers are correctly located under the spout edge.
- Replace the stainless steel cover and then push the central spout back up into position.

Cleaning the milk system with detergent

The milk system detergent was developed specifically for this coffee machine. It is available from Miele.

SELECT TYPE OF DRINK will appear in the display.

- Place a suitable container under the main dispenser.
- Put the detergent in a container with approx. 5 oz. (150 mL) of lukewarm water. Place the container beside the coffee machine.
- Press the OK button until MENU appears in the display.

- Turn the rotary selector until MAINTENANCE appears in the display. Press the OK button.
- Select CLEAN MILK SYSTEM and press the OK button.
- Select START and press the OK button.

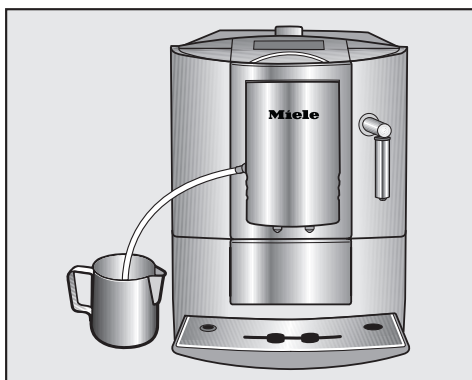

- Place the milk tube into the container when prompted to do so in the display. Make sure that the milk tube is sufficiently submerged in the cleaning solution.
- Follow the instructions given in the display.
- When PROGRAM FINISHED appears in the display, press the OK button.

The milk system has been cleaned.

Cleaning the stainless steel milk flask

(depending on the model)

The milk flask should be taken apart and cleaned every day.

- Clean all parts **by hand only** using hot water and liquid dish soap. If necessary, a small brush can be used to remove any stubborn milk deposits.
- Rinse all parts carefully under running water. Traces of dish soap can affect the taste and quality of the milk froth. Dry all parts thoroughly.
- Reassemble the milk flask.

Water container

Change the water every day to prevent a build-up of bacteria.

Make sure that the valve, the underside of the water container and the water container niche are clean. Otherwise the water container will not sit correctly.

- The water container can be cleaned in the dishwasher or by hand using hot water and liquid dish soap. After cleaning, dry the water container.
- Clean the surface the water container sits on, particularly the slots, carefully.

Cleaning and care

Drip tray cover

- Remove the drip tray cover from the drip tray.
- The drip tray cover can be cleaned in the dishwasher or by hand using hot water and liquid dish soap.
- Dry the drip tray cover thoroughly

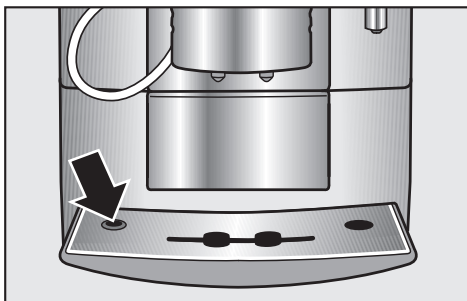

- Replace the cover onto the drip tray. Ensure that the milk tube aperture is on the left.

Drip tray and waste container

Clean the drip tray and waste container **every day** every day to avoid unpleasant smells and mildew.

The waste container is located in the drip tray.

The coffee machine will alert you via the display when the drip tray and/or waste container is full and needs to be emptied. Empty the drip tray **and** the waste container then.

TIP If the coffee machine has just been rinsed, wait a while before removing the drip tray. Rinse water will run out of the coffee dispensers.

Drip tray

- Push the coffee dispensers up as far as they will go.
- Remove the drip tray together with the waste container by pulling the drip tray forward.
- Empty the drip tray **and** waste container.
- Clean the drip tray **by hand** using warm water and liquid dish soap. Clean the waste container, if necessary (see "Waste container").
- Dry the drip tray.

Make sure that the metal contact discs on the drip tray are cleaned and dried properly. The discs will not be able to detect that the drip tray is full if they are dirty or damp.

- Clean the space under the drip tray.
- Replace the waste container in the drip tray and push the drip tray back into the coffee machine.

Make sure the drip tray has been pushed into its niche as far as it will go.

Waste container

The waste container will usually contain some residual water from the rinsing process

- Push the coffee dispensers up as far as they will go.

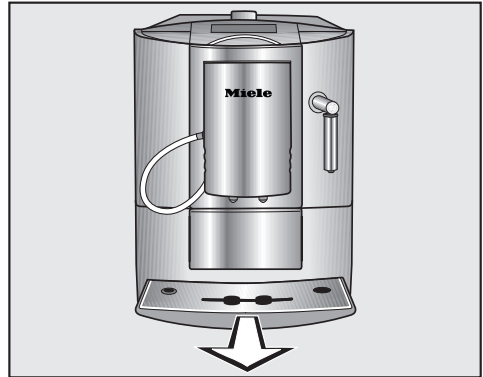

- Remove the drip tray together with the waste container by pulling the drip tray forward.
- Empty the waste container and the drip tray, if necessary. Used coffee grounds should be disposed of with organic waste or put on the compost heap.
- The waste container can be cleaned in the dishwasher or by hand using hot water and liquid dish soap. Clean the drip tray, if necessary (see "Drip tray").
- Dry the waste container.
- Replace the waste container in the drip tray and push the drip tray back into the coffee machine.

Cleaning and care

Bean container and ground coffee chute

Disconnect the coffee machine from the power supply before cleaning.

TIP Use a vacuum cleaner to remove any dry coffee residues from the bean container and the ground coffee chute.

- Open the lid on the right hand side of the coffee machine. Remove the coffee bean container lid.
- Remove any coffee beans.
- Clean the bean container with a dry, soft cloth.

The coffee bean container can now be refilled.

- Replace the coffee bean container lid.

If necessary, clean the ground coffee chute:

- Open the lid of the ground coffee chute.
- Remove any ground coffee.
- Close the lid of the ground coffee chute.
- Close the lid on the right hand side of the coffee machine.

Brew unit

Clean the brew unit **by hand only** using hot water. Do not use soap. The moving parts of the brew unit are lubricated. Soap will damage the brew unit.

Clean the brew unit once a week.

Remove the brew unit and wash by hand

The brew unit can be removed for cleaning.

- Pull out the two flaps on the right hand side of the coffee machine. Turn the flaps 90° clockwise. Open the door.

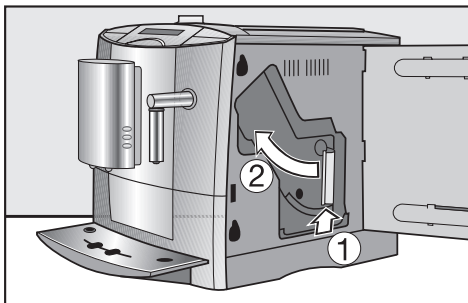

- Press the button on the end of the handle of the brew unit ① and while doing so turn the handle counterclockwise ②.

Cleaning and care

- Carefully pull the brew unit out of the coffee machine.

If you cannot remove the brew unit easily, the brew unit is not in the correct position (see "Frequently asked questions").

After the brew unit has been removed, do **not** alter the position of the brew unit handle. This would displace the brew unit and it would not fit back into the coffee machine.

- Clean the brew unit **by hand under hot running water** without soap.

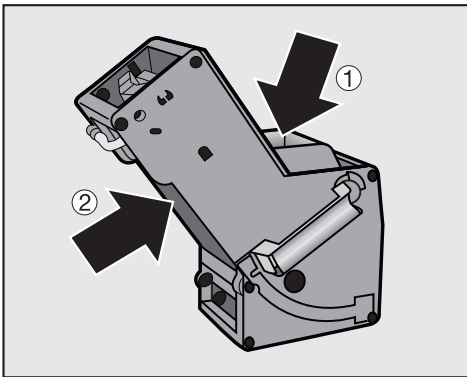

- Wipe any coffee from the two filters. One filter is located in funnel ① and the other to the left of funnel ②.
- Dry funnel area ① to prevent ground coffee sticking to it.
- Clean the inside of the coffee machine. Use your vacuum cleaner to remove dry coffee grounds.

To replace the brew unit, repeat the previous steps in the reverse order:

- Push the brew unit back into the coffee machine, making sure it is straight.

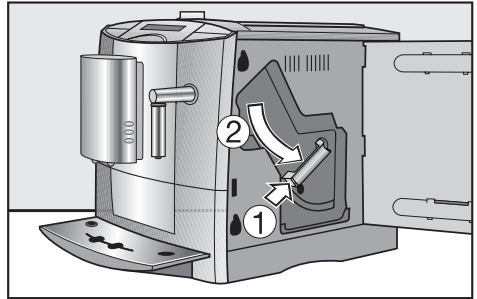

- Press the button on the end of the handle of the brew unit ① and while doing so turn the handle clockwise ②.
- Close the door. Turn the flaps 90° counterclockwise. Lower the flaps.

Cleaning and care

Cleaning the brew unit

Depending on the natural oil content of the coffee used, the brew unit can become blocked quite quickly. Use the cleaning tablets supplied to clean the brew unit.

These have been specially formulated for use in the coffee maker to optimize the degreasing. They are available from Miele.

After 200 portions have been dispensed, CLEAN THE BREW UNIT will appear in the display. This message will be displayed until the cleaning program has been carried out.

The cleaning process takes about 10 minutes.

It is important to degrease the brew unit regularly.

- Press the OK button until MENU appears in the display.
- Turn the rotary selector until MAINTENANCE appears in the display. Press the OK button.
- Select CLEAN THE BREW UNIT and press the OK button.
- Turn the rotary selector until START appears in the display. Press the OK button.

Follow the instructions about degreasing the brew unit that appear in the display.

TIP Place a suitable container underneath the coffee dispensers. Then you don't have to empty the drip tray so often.

When DROP CLEANING TAB IN GROUND COFFEE CHUTE appears:

- Open the lid on the right hand side of the coffee machine.

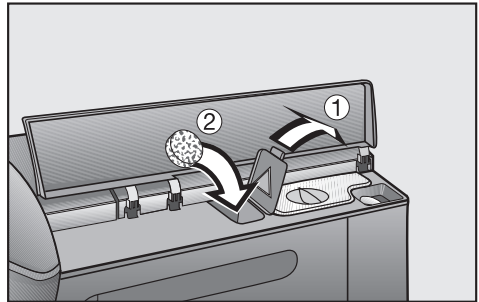

- Open the lid of ground coffee chute ①. Drop a cleaning tablet into ground coffee chute ②.
- Close both lids.
- Follow the instructions given in the display.
- When PROGRAM FINISHED appears in the display, press the OK button.

The brew unit has now been degreased.

Exterior

Remove any soiling promptly. The surfaces can become discolored or otherwise altered if soiling is not removed right away.

Make sure that no water gets in behind the display.

The exterior surfaces are susceptible to scratching. Contact with unsuitable cleaning agents could cause discoloration.

Do not dry the **mat** surfaces of black machines with a tea towel or similar. The surface can become darker and more shiny.

Ensure that any splashes during the descaling process are wiped off immediately.

- Turn the machine off using the On/Off button .
- Clean the housing with a clean, soft sponge and warm water and liquid dish soap.

Descaling

Limescale builds up in the coffee machine during use. The limescale buildup in the machine will depend on the hardness of your local water supply. Limescale must be removed regularly.

The machine will guide you through the descaling process. Various instructions will appear in the display, e.g. you will be prompted to empty the drip tray, fill the water container, etc.

Descaling **must** be carried out. The program takes approx. 30 minutes.

During the descaling program, water containing descaling agent will run out of the hot water spout. This is followed by an activation period before a little more descaling agent is dispensed.

The coffee system will remind you when the descaling program needs to be carried out. NO. PORTIONS UNTIL DESCALING: 50 will appear in the display. The remaining number of drinks that can be made before descaling will show in the display after each drink is made.

- Confirm the message with the OK button.

When 0 is reached the coffee system will lock. START THE DESCALING PROGRAM will appear in the display.

You can turn the coffee machine off if you do not want to run the descaling program at this time. However, no more drinks can be prepared until the descaling program has been completed.

TIP Place a suitable container underneath the coffee dispensers. Then you don't have to empty the drip tray so often.

Descaling following display reminder

- Press the OK button to start the descaling program.

The descaling program cannot be canceled once it has started. The program has to be carried through to the end.

Descaling solution

The descaling tablets supplied have been specially formulated for use with this coffee machine. More descaling tablets are available from Miele.

You will need one descaling tablet to descale the machine.

Only use the Miele descaling tablets supplied. Other types of descaling agents can damage the machine and affect the taste.

- Fill the water container to the "0.5 l" mark with lukewarm water.
- Place **1** descaling tablet in the water.

Be sure to mix water and descaling tablets in the right proportions. It is important that you fill the water container with enough water. Too little water can cause the descaling program to be stopped prematurely.

- Replace the water container in the coffee machine.

Various messages will appear in the display.

- Follow the instructions given.

When FILL WATER CONTAINER AND PLACE IN MACHINE appears in the display,

- Rinse the water container carefully with clean water. Be sure that no descaling agent is left in the water container. Fill the water container with cold, clean tap water up to the "max." mark.

PROGRAM FINISHED will appear in the display when the descaling process has been completed.

- Press the OK button.
- Empty the drip tray.

The descaling program is now complete and drinks can be prepared in the machine again.

When descaling the machine be sure to wipe away any splashes of descaling agent immediately. These could damage the surfaces.

After descaling the machine carefully, rinse the water container and the drip tray to remove all traces of descaling agent.

Selecting Descale from the MAINTENANCE menu

- Press the OK button until MENU appears in the display.
- Turn the rotary selector until MAINTENANCE appears in the display. Press the OK button.
- Select DESCALE and press the OK button.

The following will appear in the display:



The descaling program cannot be canceled once it has started. The program has to be carried through to the end.

- Press the OK button.

The descaling process will begin.

Energy saving mode

Eco-Mode

When using Eco Mode the coffee system will save energy.

The coffee system will switch to Eco mode if it has not been used to prepare a drink in some time. When in Eco mode the heat function is not on constantly, therefore reducing energy usage.

The coffee system will heat up again when a drink is selected.

Pre-warming the cups with hot water

If you only need to pre-heat cups occasionally, the cup warming surface can be turned off.

Hot water from the cappuccinatore can be used to pre-heat the cups instead.

Turning off





If the machine will not be used for an extended period of time, turn it off using the main switch at the back of the machine.

 Repairs should only be carried out by a qualified and trained person in accordance with local and national safety regulations. Unauthorized repairs could cause personal injury or machine damage.

Do not open the outer casing of the coffee system.

You can easily resolve many of the minor problems yourself. In some cases, an appropriate message appears in the display. To address the fault, follow the instructions on the display.

Messages in the display

Message	Possible cause and solution
FAULT - 1 FAULT - 2 FAULT - 82	<p>The coffee machine has overheated.</p> <ul style="list-style-type: none">■ Turn the machine off with the On/Off  button. Wait approx. one hour and then turn it on again.■ If the fault still appears, contact Miele Technical Service.
FAULT - 28	<p>There is too much ready ground coffee in the ground coffee chute.</p> <p>If more than one level scoop is put into the ground coffee chute the brew unit cannot process it. The ground coffee will be directed into the waste container, and a Fault will appear in the display.</p> <ul style="list-style-type: none">■ Turn the machine off with the On/Off  button. Wait approx. 2 minutes and then turn it on again.
FAULT - 73	<p>The brew unit cannot be positioned correctly.</p> <ul style="list-style-type: none">■ Turn the machine off with the On/Off  button.■ Press the  and  buttons at the same time. Then press the OK button twice. <p>This will initialize the brew unit motor and put in back into the start position.</p> <p>If the fault message appears in the display again,</p> <ul style="list-style-type: none">■ contact Miele Technical Service.

Frequently asked questions

Message	Possible cause and solution
FAULT - 74	<ul style="list-style-type: none">■ Turn the machine off and then back on again. If the fault message appears in the display again, <ul style="list-style-type: none">■ contact Miele Technical Service.
The following appears in the display, even though the drip tray is empty: EMPTY THE DRIP TRAY	The drip tray is not seated correctly <ul style="list-style-type: none">■ Push the drip tray into the coffee system into it clicks into place. or The metal contacts are dirty. <ul style="list-style-type: none">■ Clean and dry the contacts. or <ul style="list-style-type: none">■ The drip tray sensor is not working correctly.■ Turn the coffee machine off and then on again with the main switch.■ If the fault still appears, contact Miele Technical Service.
Noises can be heard from the pump and the display shows: FILL WATER CONTAINER AND PLACE IN THE MACHINE	The coffee system is trying to draw in water, even though the water tank is empty. Air is present in the pipework. <ul style="list-style-type: none">■ Fill the water container with cold, fresh tap water. SYSTEM FILLING UP - START will appear in the display. <ul style="list-style-type: none">■ Press the OK button.

Frequently asked questions

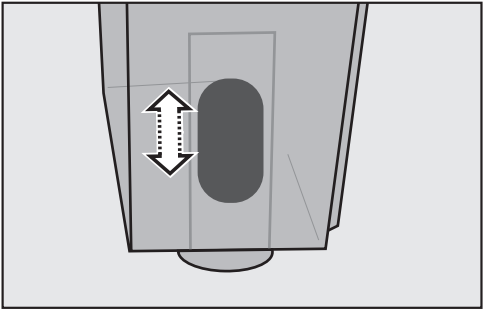
Message	Possible cause and solution
<p>The following appears in the display although the water container is full:</p> <p>FILL WATER CONTAINER AND PLACE IN THE MACHINE</p>	<p>The water tank is not seated correctly.</p> <ul style="list-style-type: none">■ Remove the water container and then replace it. <p>If the fault message appears in the display again,</p> <ul style="list-style-type: none">■ empty the water container.  <ul style="list-style-type: none">■ Check to see that the float moves freely, by shaking the water container.■ Fill the water container with fresh, cold tap water and replace it in the coffee system. <p>If the fault still appears, contact Miele Technical Service.</p>
<p>Dispensing stops and the following appears in the display:</p> <p>PROCESS STOPPED WATER CONT. EMPTY</p>	<p>There is not enough water in the water container.</p> <ul style="list-style-type: none">■ Fill the water container.■ Press the OK button. <p>CONTINUE DISPENSING - YES ✓ appears in the display.</p> <ul style="list-style-type: none">■ Press the OK button to continue dispensing, or select NO to cancel the preparation.

Frequently asked questions

Message	Possible cause and solution
<p>The message SYSTEM FILLING UP - START appears in the display again.</p>	<p>The coffee machine needs descaling and/or the brew unit filters are blocked.</p> <ul style="list-style-type: none"> ■ Turn the machine off with the On/Off  button. ■ Press the OK button for 2 seconds and call up MAINTENANCE - DESCALE. ■ Descalcify the coffee machine. ■ Remove the brew unit and rinse it under running water (see "Brew unit"). <p>If the fault message appears in the display again,</p> <ul style="list-style-type: none"> ■ Degrease the brew unit (see "Cleaning the brew unit"). <p>If the fault still appears in the display, contact Miele Technical Service.</p>
<p>The following message is displayed after turning on: RINSE THE MILK SYSTEM</p>	<p>The milk system was not rinsed prior to turning off last time.</p> <ul style="list-style-type: none"> ■ Rinse the milk system (see "Rinsing the milk system").
<p>CLEAN THE MILK SYSTEM appears in the display.</p>	<p>The milk system needs to be cleaned.</p> <ul style="list-style-type: none"> ■ Confirm this message by pressing the OK button. ■ Clean the milk system (see "Cleaning the milk system").
<p>DEMO MODE IS ACTIVE or DEMO MODE ACTIVE FUNCTION DEACTIVATED appears in the display.</p>	<p>The demo setting of the coffee machine for showrooms or dealers has been activated.</p> <ul style="list-style-type: none"> ■ Deactivate the demo mode (see "Demo mode").

Unsatisfactory results

Problem	Possible cause and solution
Water is dispensed from the coffee dispensers when coffee has been selected.	<p>The ground coffee chute lid was opened and closed without coffee being put into it. YES was then selected when the GROUND COFFEE option appeared in the display.</p> <ul style="list-style-type: none">■ If ground coffee has not been added to the ground coffee chute, NO must be selected when prompted to use GROUND COFFEE. <p>or</p> <p>Coffee beans have become stuck in the grinder</p> <ul style="list-style-type: none">■ Turn the coffee machine off with the main switch.■ Remove all coffee beans from the bean container. Use a vacuum cleaner if necessary.■ Add fresh coffee beans. Prepare a coffee drink.
Espresso or coffee flows into the cup too quickly.	<p>The grind level is too coarse.</p> <ul style="list-style-type: none">■ Set the grinder control to a finer setting (see "Adjusting the grinder setting").
Espresso or coffee flows too slowly into the cup.	<p>The grind level is too fine.</p> <ul style="list-style-type: none">■ Set the grinder control to a coarser setting (see "Adjusting the grinder setting").



Frequently asked questions

Problem	Possible cause and solution
The coffee or espresso is not hot enough	<p>The cup has not been pre-heated.</p> <ul style="list-style-type: none">■ Pre-heat the cups (see "Pre-warming cups"). <p>or</p> <p>The brewing temperature is set too low.</p> <ul style="list-style-type: none">■ Set a higher brew temperature (see "Brewing temperature"). <p>or</p> <p>The brew unit filters are blocked.</p> <ul style="list-style-type: none">■ Clean the brew unit (see "Brew unit").■ Degrease the brew unit (see "Cleaning the brew unit").
The crema on the coffee or espresso is "not right".	<p>The grinder is not set correctly.</p> <ul style="list-style-type: none">■ Set the grinder control to a coarser or finer setting (see "Adjusting the grinder setting"). <p>or</p> <p>The brew temperature is too high for the type of coffee being used.</p> <ul style="list-style-type: none">■ Set a lower brew temperature (see "Brewing temperature"). <p>or</p> <p>The coffee beans are no longer fresh.</p> <ul style="list-style-type: none">■ Add fresh beans to the coffee bean container. <p>or</p> <p>The coffee dispensers are too high.</p> <ul style="list-style-type: none">■ Pull the dispensers down until they are at the same height as the cup rim.

Unusual performance of the coffee machine

Problem	Possible cause and solution
When a drink is selected very little or nothing at all is dispensed from the coffee dispensers.	The brew unit filters are blocked. <ul style="list-style-type: none">■ Clean the brew unit (see "Brew unit").■ Degrease the brew unit (see "Cleaning the brew unit").
Water has stopped flowing when programming the amount.	The maximum water quantity possible was reached. Preparation is stopped and the max. portion size possible is saved. or There was not enough water in the water tank. The programming process is canceled and the setting will not be saved. <ul style="list-style-type: none">■ Fill the water container.■ Repeat the programming procedure.
The coffee machine does not rinse itself when turned on.	This is not a fault. If the coffee machine still has an operating temperature higher than 140 °F (60°C), rinsing will not take place.
There is a lot of "coffee water" in the waste container.	The grind level is too coarse. <ul style="list-style-type: none">■ Set the grinder control to a finer setting (see "Adjusting the grinder setting").■ Adjust the amount of coffee, if necessary (see "Adjusting the strength of the coffee").



Frequently asked questions

Problem	Possible cause and solution
<p>When the coffee system is turned on using the  button the display remains dark.</p>	<p>The main switch is turned off ("0").</p> <ul style="list-style-type: none">■ Set the main switch to on ("I"). <p>or</p> <p>The machine is not properly plugged into the outlet.</p> <ul style="list-style-type: none">■ Insert the plug into the electrical outlet. <p>or</p> <p>The circuit breaker has tripped due to a problem with the coffee machine, the electricity supply or another machine.</p> <ul style="list-style-type: none">■ Remove the power plug from the electrical outlet.■ Contact a qualified electrician or Miele Technical service for assistance.
<p>The display lights up but the coffee machine does not heat up and no drinks are prepared.</p> <p>The coffee machine cannot be turned off with the On/Off button .</p>	<p>The demo setting of the coffee machine for showrooms or dealers has been activated.</p> <ul style="list-style-type: none">■ Deactivate the demo mode (see "Demo mode").
<p>The coffee machine turns off suddenly.</p>	<p>The programmed turn off time has been reached.</p> <ul style="list-style-type: none">■ If desired set a new turn off time (see "Timer"). <p>or</p> <p>The machine is not properly plugged into the outlet.</p> <ul style="list-style-type: none">■ Insert the plug into the electrical outlet.

Frequently asked questions

Problem	Possible cause and solution
The coffee machine does not turn on at the programmed and activated "Switch on at" time.	The system lock is activated. ■ Deactivate the system lock. See "System lock". or The coffee system was not used after being turned on three times in a row automatically. ■ Turn the machine on and prepare a drink. or Eco mode is activated. The timer function is not available in this mode. ■ Select Comfort mode (see "Operating modes").
The grinder is louder than usual.	The beans could contain stones. ■ Turn the machine off immediately. ■ Contact Technical Service. or The coffee bean container has become empty during the grinding process. ■ Fill the coffee bean container with fresh beans.
The grinder setting control will not move.	The control is blocked. ■ Prepare a coffee drink. ■ Reset the grinder setting while grinding is in progress.
Milk is dripping out of the cappuccinatore even though no milk is being dispensed.	The level of milk in the milk flask is higher than the cappuccinatore. ■ Push the coffee dispensers up as far as they will go. ■ Use a smaller milk flask if necessary.

Frequently asked questions

Problem	Possible cause and solution
<p>The brew unit cannot be removed, or the brew unit cannot be replaced in the coffee system</p>	<p>The brew unit or the brew unit motor is not in the correct position. This can happen if the brew unit or the drip tray is pulled out while brewing is taking place.</p> <ul style="list-style-type: none"> ■ Turn the machine off with the On/Off  button. ■ Press the  and  buttons at the same time. Then press the OK button twice. <p>This will initialize the brew unit motor and put in back into the start position.</p> <p>If the brew unit still cannot be removed or replaced in the machine,</p> <ul style="list-style-type: none"> ■ Contact Miele Technical Service.
<p>The descaling program was started unintentionally.</p>	<p>The descaling program cannot be canceled once the OK button has been pressed.</p> <p>The process must run through to completion. This is a safety measure to ensure that the machine is fully descaled. It is important for the long-term protection of the machine and to ensure that it functions properly.</p> <ul style="list-style-type: none"> ■ Complete the descaling program (see "Descaling".)
<p>Loud noises are heard during the descaling program.</p>	<p>This is not a fault.</p> <p>These noises occur when water is flushed through the machine at a high pressure.</p>
<p>The heating-up time is longer than usual, the amount of water being dispensed is not right and the coffee machine is not performing correctly.</p>	<p>The coffee machine needs to be descaled.</p> <ul style="list-style-type: none"> ■ Complete the descaling program (see "Descaling".)

Repairs

In the event of a fault which you cannot correct yourself please contact the Miele Service Department by phone number at the back of this booklet.

- Please quote the model type and number of your appliance.

These can be found on the data plate located behind the drip tray inside the coffee system.

Accessories

The following accessories are included with your coffee system **depending on the model**:

- **Measuring spoon**
for ground coffee
- **Integrated cappuccinatore**
as a spare part
- **Cleaning tablets**
to clean/degrease the brew unit
- **Descaling tablets**
for descaling the water pipework
- **Test strips**
to determine the water hardness level
- **Cleaning**
brush for cleaning the milk tube
- **Milk flask**
for storing and keeping milk cool longer

These products and other useful accessories can be ordered on the Internet at www.mieleusa.com.

If the coffee machine will not be used for an extended period of time, e.g. vacation, or will be transported over a long distance, the machine should be prepared as follows.

Please note:

- Empty and clean the coffee bean container
- Empty and clean the water container
- Evaporating the coffee machine
- Clean the drip tray and waste container
- Pack the machine securely

Evaporating the coffee machine

The coffee machine should be evaporated before it is stored for a long period of time or transported any distance - particularly at temperatures below freezing.

Evaporating the machine will remove all traces of water from the system. This prevents water and frost damage.

- Turn the machine off with the On/Off  button.
- Empty the water container.

TIP Place a suitable container underneath the hot water spout.

- Press the OK button.
- Then press the  button twice.

The evaporation process starts, the coffee machine heats up and DRAIN THE SYSTEM appears in the display.

Caution! Danger of scalding and burns. Hot steam will escape from the cappuccinatore.

The evaporation process is complete when the message goes out.

- Turn the machine off using the main switch
- Clean the drip tray and waste container.

The coffee machine is now ready to be packed.

When you are ready to use the coffee system again it will need to be filled with water (see "First steps to use").

Packing

Only pack the machine in a clean, dry environment.
Residue of coffee grounds can cause scratches on surfaces.
Coffee, milk and water residues can cause bacteria build-up.

Use the original packaging including Styrofoam to pack the coffee system.

Keep the Operating Instructions in the box for future reference. That way they are available when the coffee machine is used again.

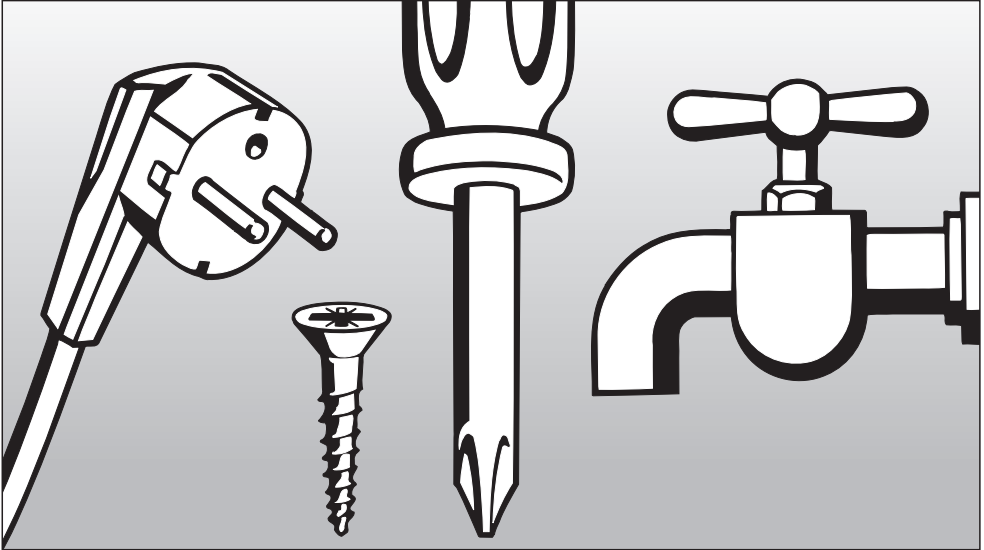

Installation instructions

Information is subject to change. Please refer to our website to obtain the most current product specification, technical & warranty information.

Electrical connection

All electrical work should be performed by a qualified electrician in strict accordance with national and local safety regulations. Installation, repairs and other work by unqualified persons could be dangerous.

Verify that the voltage, load and circuit rating information found on the data plate match the household electrical supply. This data must match to prevent damage to the coffee system. If in doubt, consult a licensed electrician.

The data plate can be found behind the drip tray inside the coffee system.

The plug will fit in the outlet only one way. If it does not fit, **DO NOT** use force and **DO NOT** modify the plug in any way. Contact a qualified electrician.

The socket should be located next to the machine and be easily accessible.

If the appliance is connected to the electrical supply with an extension cord please note:

- A short power-supply cord is to be provided to reduce risks resulting from becoming entangled in or tripping over a longer cord.
- Always use care and exercise caution with using an extension cord.
- The marked electrical rating of the extension cord should be at least as great as the electrical rating of the appliance.
- The extension cord should be a grounding-type 3-wire cord.

- A longer cord should be arranged so that it will not drape over the counter top or table top where it can be pulled on by children or tripped over.

Do not connect the appliance to a power inverter or directly to power produced outside of the normal electrical grid (i.e. direct solar or wind power source).

Direct connection to such power sources can cause power surges and tripped breakers when the appliance is turned on, and could damage the appliance.

Do not connect the appliance to energy saving plugs or outlets. The reduction of power to the appliance caused by these devices will cause the appliance to run hot and may damage it and/or shorten its usable life.

Do not operate any appliance with a damaged cord or plug. Contact Miele Technical Service.

If there is any question concerning the electrical connection of this appliance to your power supply, please consult a licensed electrician or contact Miele's Technical Service Department. See back page for contact information.

WARNING:
THIS APPLIANCE MUST BE GROUNDED

Danger of overheating!
Ensure that there is sufficient ventilation around the coffee system. Be sure the vents at the top of the machine are not covered completely.

Danger of overheating. If the coffee system is installed behind a cabinet door, it may only be used with the door open. Do not close the cabinet door while the coffee system is in use.

- Install the coffee system in a dry, well ventilated room.
- The ambient temperature should be between 50°F (10°C) and 90°F (32°C).
- The coffee machine should be installed on a water resistant, horizontal surface.
- Be sure the vents at the top of the machine are not covered completely, e.g. with a dish towel.

If the coffee machine is installed in a niche, the minimum dimensions of the niche are:

Height	20" (508 mm)
Width	17 11/16" (450 mm)
Depth	21 7/8" (555 mm)

- Position the coffee machine so that the front edge lines up with the front edge of the niche.

Dimensions

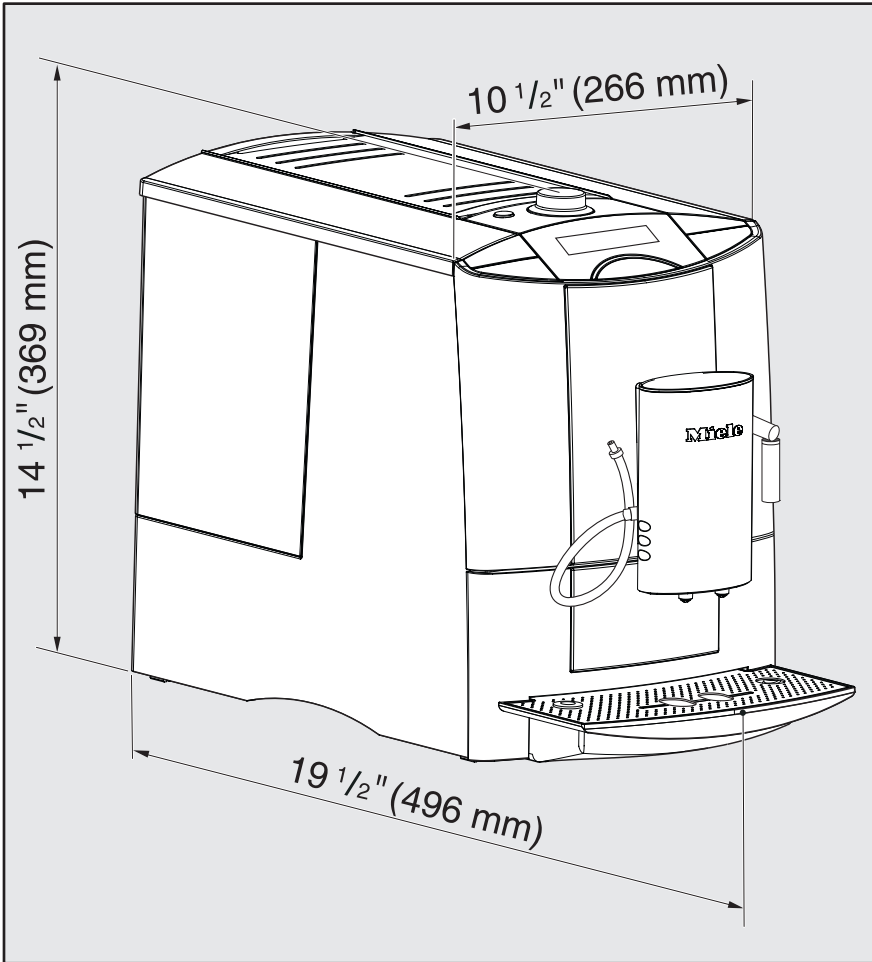

Disposal of packing material

The cardboard box and packing materials protect the appliance during shipping. They have been designed to be biodegradable and recyclable. Please recycle.

Ensure that any plastic wrappings, bags, etc. are disposed of safely and kept out of the reach of children.
Danger of suffocation!

The original packaging can be used to transport the coffee system.

Disposal of an old appliance

Old appliances may contain materials that can be recycled. Please contact your local recycling authority about the possibility of recycling these materials.

Ensure that the appliance presents no danger to children while being stored for disposal. Before discarding an old appliance, unplug it from the outlet, cut off its power cord and remove any doors to prevent hazards.

**Please have the model and serial number
of your appliance available before
contacting Technical Service.**



U.S.A. Miele, Inc.

National Headquarters

9 Independence Way
Princeton, NJ 08540
Phone: 800-843-7231
609-419-9898
Fax: 609-419-4298
www.mieleusa.com

Technical Service & Support Nationwide

Phone: 800-999-1360
Fax: 888-586-8056

TechnicalService@mieleusa.com

Canada Miele Limited

Headquarters and Showroom

161 Four Valley Drive
Vaughan, ON L4K 4V8
Phone: 800-643-5381
905-660-9936
Fax: 905-532-2290
www.miele.ca
professional@miele.ca
(commercial enquiries)

MieleCare National Service

Phone: 800-565-6435
905-532-2272
Fax: 905-532-2292
customercare@miele.ca
(general and technical enquiries)

Germany

Miele & Cie. KG
Carl-Miele-Straße 29
33332 Gütersloh