

Miele

Operating Instructions



Freestanding coffee machine CM 5100

To prevent accidents
and machine damage
read these instructions

before
installation or use.

en - US, CA

M.-Nr. 07 995 311

Contents

IMPORTANT SAFETY INSTRUCTIONS	4
Guide to the machine	8
Accessories	10
First steps to use	11
Before the first use	11
Turning on	11
Water hardness	12
Filling the water tank	14
Filling the coffee bean container	15
Turning the machine On / Off	16
Pre-heating cups	17
Turning the cup warmer on and off	17
Pre-heating cups using the cup warming function	17
Preparing coffee or espresso	18
Preparing two portions at one time	18
Adjusting the height of the coffee dispensers	19
Making coffee or espresso using ground coffee	20
Adding ground coffee	20
Preparing coffee/espresso using ground coffee	21
Frothing and heating milk	22
Preparing milk froth	23
Preparing hot milk	24
After preparing milk	24
Milk temperature	25
Milk froth consistency	25
Preparing a cappuccino	25
Preparing a Latte Macchiato	25
Preparing hot water	26
Adjusting the grinder setting	27
Adjusting the strength of the coffee	28
Pre-brewing the coffee	29
Brewing temperature	30
Setting the serving size	31
SETTINGS Menu	33
Options menu	34
Language	35

Time of day and clock display	36
Timer	37
Default settings	40
Operating modes	41
System lock	42
Displaying information	43
Cleaning and care	44
Quick guide	44
Rinsing the system.	45
Cappuccinatore	47
Milk flask	48
Water tank	48
Drip tray cover	49
Drip tray and waste container	49
Coffee bean container	51
Brew unit	51
Exterior.	54
Descaling	55
Energy saving mode	57
Transport	58
Evaporating the coffee system	58
Frequently Asked Questions	59
After sales service	68
Installation instructions	69
Caring for the environment	70
Electrical connection	71
Installation	72
Dimensions	73

IMPORTANT SAFETY INSTRUCTIONS

When using electrical appliances basic safety precautions should always be followed, including the following:

Read all instructions before installation or use of the coffee system.

Please read these instructions carefully to prevent accidents and machine damage.

This appliance complies with current safety requirements. Improper use of the appliance can cause personal injury and material damage.

Read this safety information carefully before operating the appliance. They contain important information on the safe installation, operation, and care of your coffee system. To avoid the risk of personal injury or damage to the coffee system, it is important that you carefully read the instructions.

Keep these instructions in a safe place and pass the on to any future user.

Proper use

► This coffee system is not designed for commercial use. It is intended for household use and only (up to 20 cups per day), for the preparation of coffee, cappuccino, espresso, etc.

Do not use appliance other than for its intended use. Any other use could be dangerous.

► This coffee system is not suitable for outdoor use.

► Persons which lack physical, sensory or mental abilities or experience with the machine should not use it without supervision or instruction by a responsible person.

Children

► Keep the coffee system out of reach of children.

► Close supervision is necessary when any appliance is used by or near children. They could easily be scalded or burned.

The coffee dispensers and cappuccinatore can become very hot.

IMPORTANT SAFETY INSTRUCTIONS

Technical safety

- ▶ Before installing the appliance, check for externally visible damage. Do not operate a damaged appliance.
- ▶ Before connecting the appliance to the electrical supply make sure that the voltage and frequency listed on the data plate correspond with the household electrical supply. If in doubt, consult a qualified technician. To disconnect, turn the main switch at the back of the machine to 0, then remove the plug from the wall outlet.
- ▶ Be certain your appliance is properly installed and grounded by a qualified technician. To guarantee the electrical safety of this appliance, continuity must exist between the appliance and an effective grounding system. It is imperative that this basic safety requirement be met. If there is any doubt, have the electrical system of the house checked by a qualified electrician.
- ▶ Do not operate any appliance with a damaged cord or plug, or after the appliance malfunctions or has been damaged in any manner. Contact Miele.
- ▶ Ensure that the power cord will not be pinched or damaged by any sharp edges.
- ▶ Do not let the cord hang over the edge of a table or counter, or touch hot surfaces. Push the excess cord into the hole at the back of the coffee system.
- ▶ The ambient temperature should be between 50°F (10°C) and 90°F (32°C).
- ▶ Be sure the vents at the top of the machine are not completely covered, e.g. with a dish towel.
- ▶ If the appliance is installed behind a door front, use the appliance only when the door front is open. Do not close the door front when the appliance is in operation.
- ▶ Do not place the appliance on or near a hot gas or electric burner, or in a heated oven.
- ▶ The use of accessory attachments not recommended by the appliance manufacturer may result in fire, electric shock or injury to persons.
- ▶ Repairs must only be performed by a trained technician in accordance with national and local safety regulations. Repairs and other work by unauthorized persons could be dangerous and may void the warranty.
- ▶ While the appliance is under warranty repairs should only be performed by an authorized service technician. Otherwise the warranty is void.
- ▶ Defective components should be replaced by Miele original spare parts only. Only with these parts can the manufacturer guarantee the safety of the appliance.
- ▶ Before cleaning and care disconnect the power supply by either removing the fuse, "tripping" the circuit breaker or unplugging the unit.

IMPORTANT SAFETY INSTRUCTIONS

- ▶ Never open the outer casing of the appliance. Tampering with electrical connections or components and mechanical parts is dangerous and may cause machine damage.
- ▶ To protect against fire, electric shock and injury to persons do not submerge the cord or plugs in water or other liquids.
- ▶ If the coffee system will not be used for an extended period of time, turn it off by using the main power switch.

Safety

Use Caution. There is a risk of burns when dispensing beverages. The coffee dispensers, cappuccinatore, liquids and steam get very hot.

- ▶ Keep away from the areas under the coffee dispensers and cappuccinatore when beverages or steam are being dispensed.
- ▶ Do not touch hot components.
- ▶ Be sure the cappuccinatore is fitted correctly and only use it if it is clean. If it becomes clogged hot liquid or steam could splash.
- ▶ Do not use the coffee system to clean objects.
- ▶ Before the first use, flush the supply lines thoroughly clean the coffee system (see "Cleaning and care").
- ▶ Only fill the water tank with cold, fresh tap water. Warm or hot water, or any other liquids may damage the machine. The water should be changed daily to prevent bacteria or mold growth.
- ▶ Do not use deionized or mineral water. They may lead to heavy calcium build-up in the machine that can damage the unit.
- ▶ Only roasted whole coffee beans should be put in the bean container.
- ▶ Sugar can damage the appliance! Caramelized or otherwise pre-treated coffee beans or other sugar containing beverages must not be put in the machine.
- ▶ Do not reach into the grinder.
- ▶ Do not place anything into the brew unit but ground coffee or a cleaning tablet.
- ▶ Always place the milk flask on a level surface. Be sure that the milk container is protected from heat, for example not right next to the stove.
- ▶ Clean the coffee system and the milk flask thoroughly before use. Rinse the cappuccinatore lines and system (see "Cleaning and Care").
- ▶ Clean the coffee system and the milk flask daily (see "Cleaning and Care"). The milk flask is not dishwasher safe, it must be washed by hand.
- ▶ Only use plain milk. Flavored milk products contain substances that can clog the coffee system.

IMPORTANT SAFETY INSTRUCTIONS

- ▶ Never place a cup with an alcohol-coffee mixture under the coffee dispenser. Plastic parts of the unit could catch fire!
- ▶ Do not place anything that produces an open flame such as a candle on top of or next to the coffee machine. Danger of fire!
- ▶ Disconnect the coffee machine from the electrical supply before cleaning.
- ▶ Clean the coffee system daily, see "Cleaning and care".
- ▶ Do not use a steam cleaner to clean the coffee system.
- ▶ The appliance must be descaled regularly with the supplied descaling tablets. In areas with very hard water the machine may need to be descaled more often.
- ▶ Clean/degrease the brew unit regularly with the supplied cleaning tablets. Depending on the oil content of the coffee, the brew unit can clog.

**SAVE THESE INSTRUCTIONS
AND REVIEW THEM
PERIODICALLY**

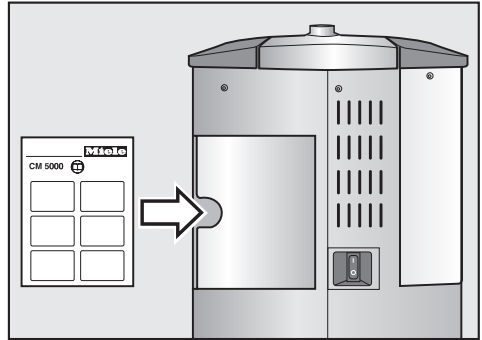

Quick Guide

A Quick Guide is supplied to give basic information on how to operate and clean the machine on a daily basis.

The Quick Guide does not replace the Operating manual.

Please read all instructions, especially the "Important Safety Instructions", before using the coffee system.

For easy reference, keep the quick guide in the slot at the back of the machine.

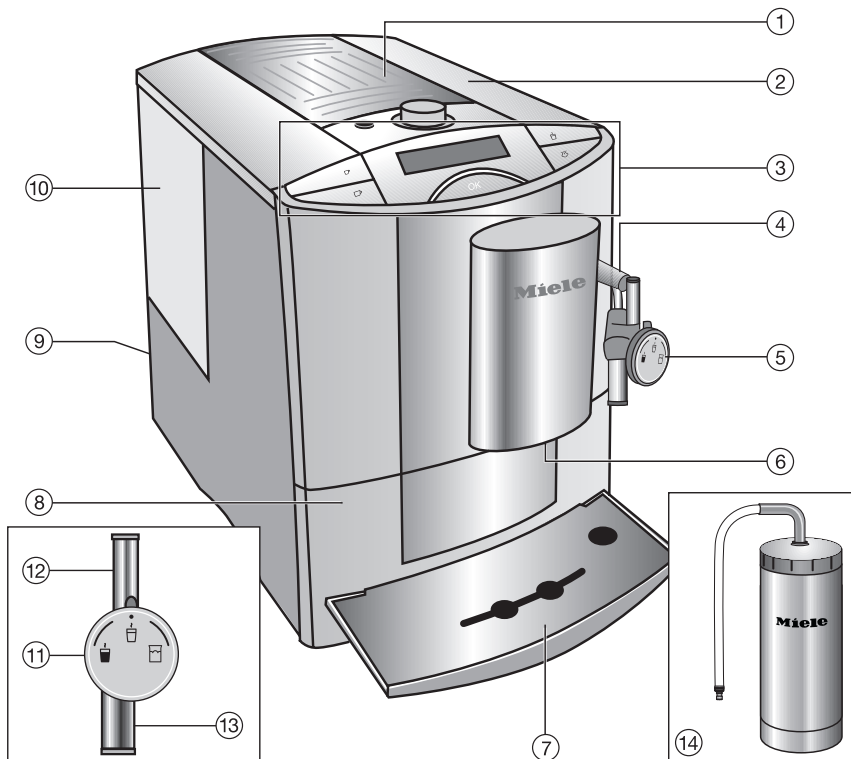

Guide to the machine



- ① Cup warming surface
- ② Bean container, ground coffee chute and rotary selector to control the fineness of the ground coffee
- ③ Display and controls
- ④ Steam and hot water dispenser
- ⑤ Cappuccinatore (see inset diagram)
- ⑥ Coffee dispensers
- ⑦ Drip tray cover
- ⑧ Drip tray and waste container
- ⑨ Main switch
- ⑩ Water tank

- ⑪ Cappuccinatore control, to select hot milk, hot water or milk froth
- ⑫ Air intake nozzle
- ⑬ Dispenser
- ⑭ Milk flask with tubing

Cappuccinatore symbols:

-  Hot water
-  Milk froth
-  Hot milk

Display and controls

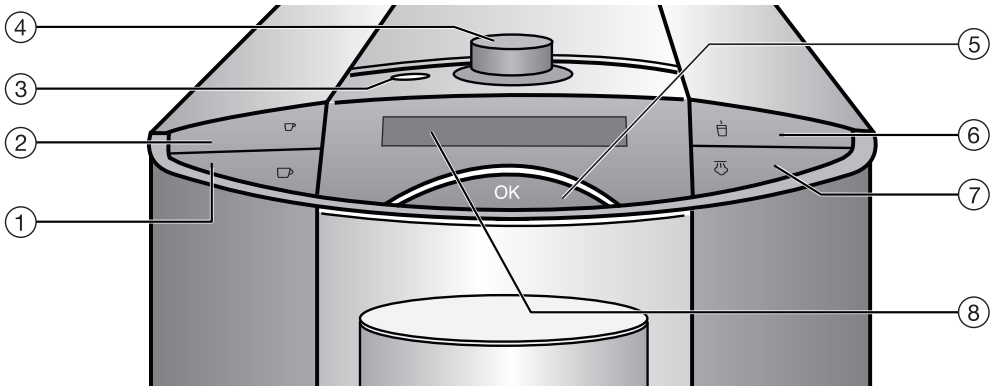

	Control	Action	Function
①	Coffee button ☐	Press	To dispense coffee
②	Espresso button ☐	Press	To dispense espresso
③	On/Off button ⏻	Press	Turns the machine On/Off (Standby mode)
④	Rotary selector	Turn in either direction	Displays options or settings
⑤	OK button	Press	Confirms a selection or action Cancels beverage preparation Brings up the SETTINGS menu (Press and hold for 2 seconds) The OK button will light up if the option is available. The OK button will blink before steam is generated.
⑥	Hot water button ☒	Press	To dispense hot water
⑦	Steam button ☕	Press	To dispense milk froth or hot milk
⑧	Display		Displays messages From here you can customize the coffee system (in the SETTINGS menu)

Accessories

The following accessories come included with your coffee system:

- **Measuring spoon**
for ground coffee
- **Cleaning tablets**
to clean/degrease the brew unit
- **Descaling tablets**
for descaling the water pipework
- **Test strips**
to determine the water hardness level
- **Milk flask**
for storing and preparing milk

Optional accessory

- **Microfiber cloth (optional accessory)**
for removing finger prints and light soiling

These accessories and others are available from your Miele dealer or online at www.Mieleusa.com.

Before the first use

Clean the appliance and remove protective foils before the first use. See "Cleaning and Care".

- Plug in the appliance. If the power cord is too long, it can be pushed into the hole in the back of the unit.
- Fill the coffee bean container. See "Filling the beans container").
- Fill the water tank with fresh, cold tap water. See "Filling the water tank").

Turning on

When the coffee system is turned on for the first time and after the welcome screen appears, you will be prompted to set the following:

- Language
- Clock format
- Time of day

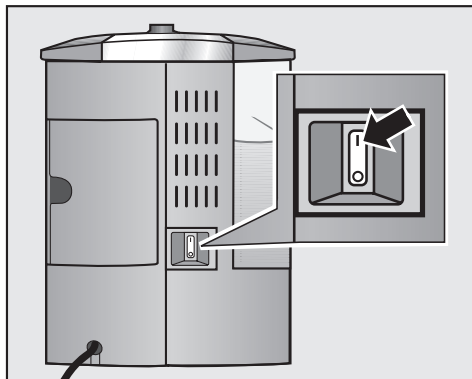

- Turn On "I" the main switch at the back of the machine.
- Press the On/Off  button.

The welcome message MIELE - WILLKOMMEN appears briefly in the display.

Setting the language

- Turn the rotary selector until the desired language appears in the display.
Press OK to confirm.

The setting is now saved.

First steps to use

Setting the clock format

- Turn the rotary selector until the desired clock format (12 hour or 24 hour) appears in the display.

The setting has now been saved.

Setting the time of day

- Turn the rotary selector until the current hour appears. Confirm with OK.
- Repeat for the minutes. Confirm with OK.

The setting is now saved. SET UP SUCCESSFUL will now appear in the display.

- Press the OK button.

If the water container needs to be filled the following message will appear in this display:

FILL WATER CONTAINER
AND PLACE IN MACHINE

- Fill the water tank with cold, fresh tap water.

The following now appears in this display:

SYSTEM FILLING UP
START

- Press the OK button.

Water hardness

The hardness of the water used in the coffee system must be determined and programmed into the appliance. The water hardness will determine how frequently the unit must be descaled to maintain the coffee system properly. The machine monitors the volume of water passing through it in conjunction with the hardness of the water and will indicate when descaling is necessary. Your local water authority can tell you the hardness of your tap water or you can measure it yourself using the enclosed test strip.

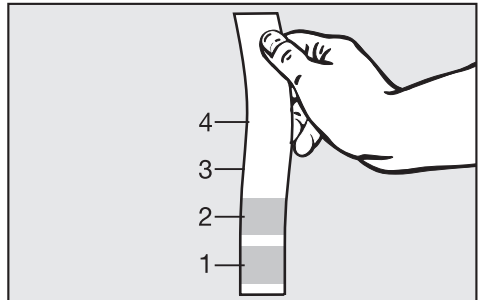

- Place the test strip under your kitchen tap for a second and shake off any remaining water. The result is visible in about 1 minute.

The appliance can be set to one of 4 hardness levels:

- **Level 1 (soft):**
0 - 3 gr/gal (0 - 3 °d)
- **Level 2 (moderate):**
4 - 7 gr/gal (4 - 7 °d)
- **Level 3 (hard):**
7 - 15 gr/gal (7 - 14 °d)
- **Level 4 (very hard):**
15 - 22 gr/gal (14 - 21 °d)

Setting the water hardness

- In the main menu, press the OK button for two seconds.



- Turn the rotary selector until WATER HARDNESS appears in this display. Confirm with OK.
- Turn the rotary selector until the desired water hardness level appears in the display. Confirm with OK.

The setting is now saved.

Filling the water tank

The quality of the water used plays an important part in the overall quality of the coffee.

The water tank should be emptied and filled with fresh, cold tap water.

Hot or warm water, or other liquids could damage the coffee system.

Do not use mineral water. Mineral water will cause lime scale deposits to build up in the machine, possibly damaging it.

- Fill the water tank with fresh, cold tap water to the "Max." mark.

Be sure the area under the water tank is clean and free of obstructions. If the water tank is not seated correctly the drainage valve will not be sealed. Clean if necessary.

- Replace the water tank. Make sure the tank fits correctly onto the notch at the top of the housing.
- Close the lid.

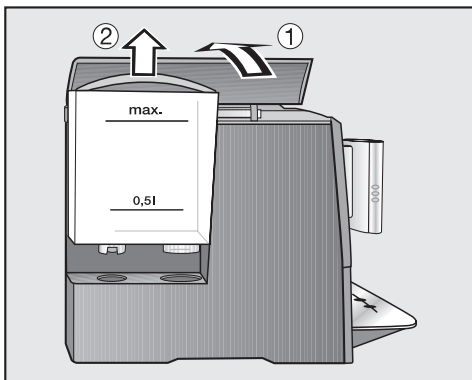

- Open the lid on the left hand side of the coffee system ①. Pull the water tank up and out using the handle ②.

Filling the coffee bean container

Fill the coffee bean container with roasted espresso or coffee beans.

Important: Only use roasted espresso or coffee beans in the container.

Anything else, including ground coffee, will damage the grinder.

Important: Do not use coffee beans that have been treated with sugar, caramel or other substances. Do not put drinks containing sugar in the coffee bean container. Sugar will damage the machine.

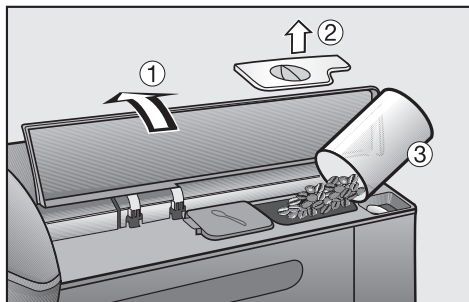

- Open the lid on the right of the coffee system ①. Remove the coffee bean container lid ②.
- Fill the container ③ with roasted coffee beans.
- Replace the bean container lid, close the coffee system lid.

TIP Only add enough beans to last for a few days. Contact with the air causes the beans to lose their flavor.

Turning the machine On / Off

The On/Off  button (Standby) can be used to turn the coffee system on or off, if the main switch at the back of the machine is turned on.

Turning on

When the On/Off  button is pressed, the coffee system will heat up.

If the coffee system was used recently and still has an operating temperature higher than 140°F (60°C), rinsing will not take place.

- Press the On/Off button .

The following appears in the display:



HEATING-UP PHASE

If the automatic rinsing has been **turned on**, the following will appear in the display after the heat-up phase is complete:



RINSING

Hot water will be dispensed from the coffee spouts.
The main menu will then appear.



SELECT TYPE OF DRINK

Beverages can now be prepared.

Turning off

- Press the On/Off button .

If the automatic rinsing function has been **turned on**, the pipework will be rinsed before the coffee system turns itself off.

If you have switched the automatic rinsing **function off**, the pipework should be rinsed manually (see, "Cleaning and care") before turning off the machine.

In order to allow the flavor of the coffee to develop and be retained, the cups should be pre-heated.

The smaller the volume of coffee/espresso and the thicker the cup, the more important it is to pre-heat the cup.

The cup warmer on the top of the coffee system can be used to pre-heat coffee cups and glasses. The cup warming function must be turned on.

TIP Cups can also be warmed with hot water by using the  button.

Turning the cup warmer on and off

- In the main menu, press and hold OK for two seconds.



- Turn the rotary selector until CUP HEATING appears in the display. Confirm with the OK button.
- Turn the warming function on or off by selecting YES or NO (as desired) in the display.
- Confirm by pressing the OK button.

Pre-heating cups using the cup warming function

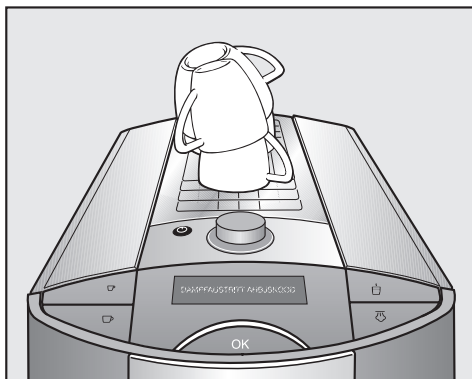

- Arrange the cups or glasses on the top of the coffee machine.

The cup warming surface will be heated continuously until the coffee system is turned off.

Preparing coffee or espresso

When the ☐ or ☑ buttons are pressed, the coffee system automatically grinds the beans to brew the coffee.



- Place a cup under the coffee dispensers.
- Press the button for the desired beverage:
 - ☐ for coffee, or
 - ☑ for espresso.

The chosen beverage will now be dispensed.

To ensure that any residues from the factory testing process are removed from the brewing system, please discard the first two cups of coffee when using the machine for the first time.

Preparing two portions at one time

Two portions of coffee or espresso can be prepared at the same time. The coffee system will make two portions one right after the other.



- Place one cup under each of the coffee dispensers.
- Press the button for the desired beverage **twice**:
 - ☐ for coffee, or
 - ☑ for espresso.

Two portions of coffee/espresso will be dispensed from into the cups.

TIP To prepare a **double coffee or espresso** follow the same procedure as listed above except place only one cup under both dispensers.

Preparing coffee or espresso

Canceling preparation

The coffee/espresso preparation can be canceled when STOP? appears in this display. Any coffee beans which have already been ground will be directed into the waste container.

- Press the OK button.

The preparation will be canceled.

Adjusting the height of the coffee dispensers

The coffee dispensers can be raised or lowered to the height of your cup. If the dispensers are closer the beverage will not cool down as quickly and the crema will have a better consistency.

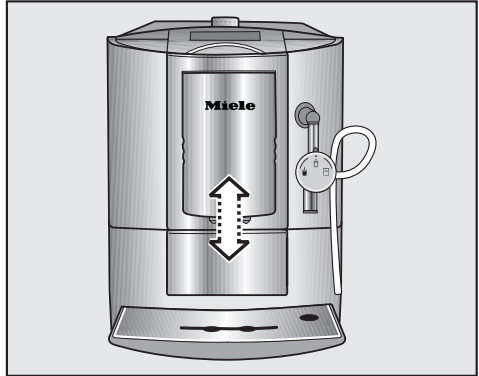

- Pull or push the coffee dispenser up or down as needed.

Making coffee or espresso using ground coffee

One portion at a time of coffee or espresso can be using ground coffee.

This allows you to prepare a decaffeinated coffee, if the bean container is already filled with regular coffee beans for example.

The coffee system will automatically recognize that ground coffee has been placed in the chute.

Use the scoop supplied with the machine to ensure the correct amount of ground coffee is used.

The machine will use all the ground coffee in the chute, if too much is added the brew unit will not be able to process the coffee.

Adding ground coffee

- Open the lid on the right of the coffee system ①.
- Open the lid for the ground coffee chute. Add one level scoop of ground coffee.
- Close the lids.

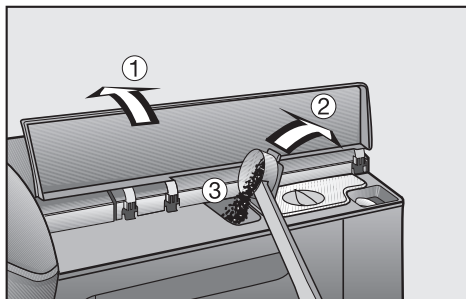

The following message appears in this display:



- To prepare the coffee/espresso using ground coffee, confirm with OK.

To **cancel preparation** with ground coffee, turn the rotary control until NO appears in the display. Confirm with OK.

The ground coffee will be directed into the waste container.

Making coffee or espresso using ground coffee

Preparing coffee/espresso using ground coffee

The following message appears in this display:



SELECT DRINK
USE GROUND COFFEE

- Place a cup under the coffee dispensers.
- Press the button for the desired beverage:
 - ☐ for coffee, or
 - ☑ for espresso.

The beverage is now prepared.

Canceling preparation

Coffee preparation can be canceled when STOP? appears in this display. Any coffee which has already been ground will be directed into the waste container.

- Press the OK button.

The preparation will be canceled.

Frothing and heating milk

The coffee system draws milk through a tube from the milk flask. Steam is then used to heat the milk in the cappuccinatore. If desired, the milk can also be frothed this way.

In order to produce the best milk froth, use cold milk. The milk flask will keep the milk cold for an extended period of time.

Preparing the milk flask

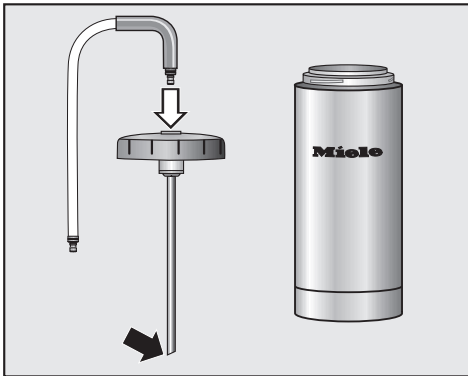

- Insert the stainless steel suction tube to the inside the lid. Be sure that the slanted end is pointed downwards (as shown).
- Fill the milk flask up to a maximum of 3/4" (2 cm) below the rim..
- Place the lid on the flask.

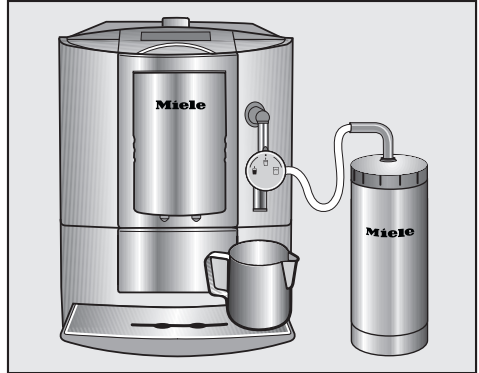

- Connect the stainless steel angled end of the milk tube to the top of the lid until it clicks into place.
- Place the milk flask on the right hand side of the coffee system.
- Connect the other end of the milk tube to the cappuccinatore.

Caution! The cappuccinatore will become hot - danger of burns.

Preparing milk froth

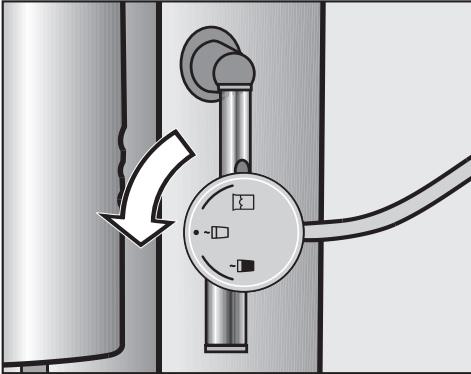

- Turn the cappuccinatore dial to ☕.
- Place a cup or suitable container under the cappuccinatore.
- Press the ☑ button.

The coffee system will heat up. HEATING-UP PHASE will appear in the display. After heating the milk froth will be dispensed into the container underneath.

- Press the OK button when enough milk froth has been prepared.

TIP For best results use cold milk.

Frothing and heating milk

Preparing hot milk

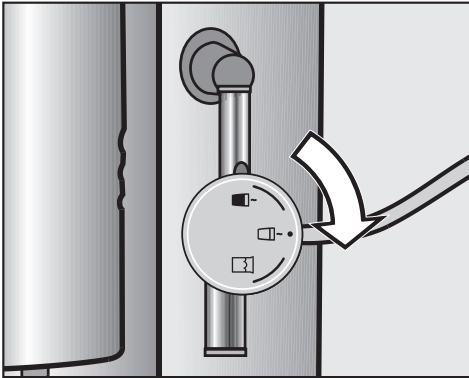

- Turn the cappuccinatore dial to the ☐ position.
- Place a cup or suitable container under the cappuccinatore.
- Press the ☐ button.

The machine will heat up and HEATING-UP PHASE will appear in the display. After being heated the hot milk will be dispensed from the cappuccinatore into the container underneath.

- Press OK when enough hot milk has been dispensed.

Canceling preparation

Milk preparation can be canceled when STOP? appears in this display.

- Press the OK button.

The preparation is canceled.

After preparing milk

To prevent the build-up of milk residues, the cappuccinatore needs to be cleaned if more than one hour has elapsed since a drink with milk was prepared.

Milk temperature

The cappuccinatore dial can be used to adjust the temperature of the milk.



- Turn the dial to:
 - ① for warm milk, or
 - ② for hot milk.

Milk froth consistency

The cappuccinatore dial can also be used to adjust the consistency of the milk froth.

- Turn the dial to:
- ③ for hot milk froth with a thinner consistency, or
 - ④ for warm milk with a thicker consistency.

Preparing a cappuccino

- Fill the cup half way with milk froth.
- Place the cup under the coffee dispensers and prepare an espresso.

Preparing a Latte Macchiato

- Fill a Macchiato glass one third full with hot milk.
- Top the hot milk with one third of milk froth.
- Place the glass under the coffee dispensers and prepare an espresso.

Preparing hot water

If the cappuccinatore has been used to prepare hot milk or milk froth, the cappuccinatore needs to be rinsed. See "Cleaning and care".

Use caution. Danger of burning or scalding on the cappuccinatore. The liquid and steam dispensed are very hot.

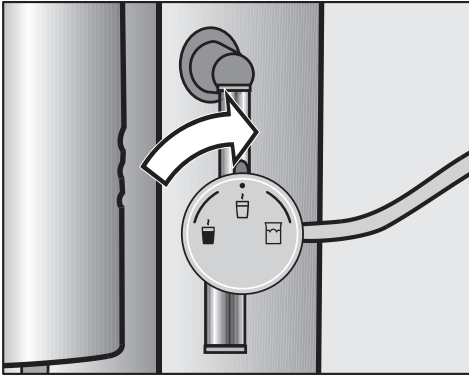

- Turn the cappuccinatore dial to ☕.
- Place a cup or suitable container under the cappuccinatore.
- Press the ☕ button.
- Press the OK button when enough hot water has been prepared.

Adjusting the grinder setting

The grinder setting should be adjusted to suit the type of coffee you are using.

When the beans are ground correctly the coffee or espresso will flow evenly into the cup and have a good crema.

The coffee is ground **too coarse**, if

- the espresso or coffee flows into the cup too quickly.
- the crema is very pale and uneven.

The coffee is ground **too fine**, if

- the espresso or coffee flows into the cup very slowly.
- the crema is dark brown.

To avoid damaging the grinder :

- only adjust the setting when it is in operation,
- only adjust the grinder one setting at a time.
- grind the coffee beans again if you would like to adjust the grinder to the next finer setting.

- Place a suitable container under the coffee dispensers.
- Open the lid on the right hand side of the coffee system.
- Select ☐ or ☐.

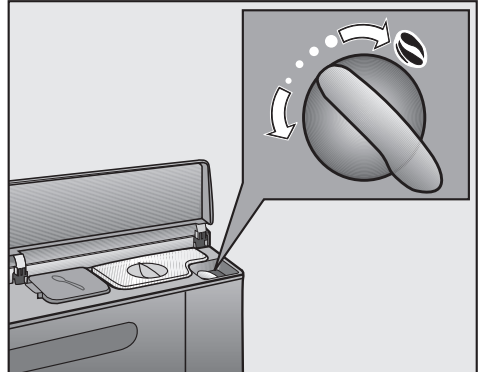

- Turn the rotary selector for the grinder counter-clockwise for a **finer** grind or clockwise for a **coarser** grind.

The new grinder setting will not take effect until after the second coffee has been prepared.

Adjusting the strength of the coffee

The ground coffee amount can be set between 0.2 ounces and 0.5 ounces (6 - 14 grams). The greater the quantity the stronger the coffee or espresso will be.

The coffee amount is **too low**, if

- espresso or coffee flows into the cup too quickly.
- the crema is pale and uneven.
- the espresso or coffee lacks body.

Increase the amount of coffee so that more ground coffee is brewed with each cup.

The coffee amount is **too high**, if

- the espresso or coffee flows too quickly into the cup.
- the crema is dark brown.
- the espresso or coffee tastes bitter.

Decrease the amount of coffee so that less ground coffee is brewed with each cup.

The coffee ground amount can be altered by selecting a different setting. Three settings are available:

- mild
 - normal
 - strong
- In the main menu, press and hold the OK button for two seconds.



- Turn the rotary selector until AMOUNT OF COFFEE appears in the display. Press the OK button.
- Turn the rotary selector until COFFEE or ESPRESSO (as desired) appears in the display.
- Confirm with OK.
- Turn the rotary selector until the desired setting appears in the display. Confirm with OK.

The setting is now saved.

During pre-brewing a small amount of hot water moistens the ground coffee before the remaining water is pushed through the grounds at high pressure. This helps release the flavor of the coffee.

This function can be turned on or off. The machine is delivered with the pre-brewing function turned off.

To turn the pre-brewing function on or off

- In the main menu, press and hold the OK button for two seconds.



- Turn the rotary selector until PRE-BREWING appears in this display.
Confirm with OK.
- Turn the rotary selector until YES (on) or NO (off), as desired, appears in this display.
- Confirm with OK.

The setting is now saved.

Brewing temperature

The ideal brewing temperature depends on the type of coffee, and whether espresso or coffee is being prepared.

Three temperatures are available for coffee and espresso:

- low
- normal
- high

TIP Not all coffee can withstand high temperatures. Certain types are too delicate, which could cause poor crema to form and impair the taste.

To set the coffee/espresso temperature

- In the main menu, press and hold the OK button for two seconds.



- Turn the rotary control until TEMPERATURE appears in the display. Confirm with OK.
- Turn the rotary selector until COFFEE or ESPRESSO (as desired) appears in the display.
- Confirm with OK.
- Turn the rotary selector until the desired temperature appears in the display.

The setting is now saved.

Setting the serving size

The amount of water used for each serving of espresso, coffee or hot water can be set to suit your taste and cup size.

For drinks prepared with milk, you can also set the duration of the steam used for heating or frothing the milk.

There is a maximum amount of water that can be programmed for each type of drink. The water flow will stop automatically when the maximum amount of water has been reached.

To program the serving size you can either:

- use the ☐, ☐, ☐ or ☐ buttons, or
- select program the amount from the settings menu.

If there is not enough water in the water tank, the process will be stopped and the programmed amount **will not** be saved.

Programming using the ☐, ☐, ☐ or ☐ buttons

Setting the portion sizes for espresso, coffee and hot water

- Place a cup under the coffee dispensers.
- Press and hold the ☐, ☐ or ☐ buttons until PROG. THE AMOUNT appears in the display.

The selected drink will be prepared and SAVE will appear in the display.

- Press the OK button when the cup has been filled to the desired level.

The serving size set will now be dispensed every time the selected drink is prepared.

TIP Programming can be canceled as long as CANCEL appears in the display.

Setting the serving size

Setting the steam duration for hot milk and milk froth

The duration of steam is the same for heating milk and for frothing milk.

- Place a container with sufficient milk next to the coffee system on the right hand side. Place the milk tube into the container.
- Turn the cappuccinatore dial to the ☒ or ☑ symbol.
- Place a cup under the cappuccinatore.
- Press and hold the ☒ button until PROG. THE AMOUNT appears in the display.

Hot or frothed milk will now be prepared and SAVE will appear in the display.

- Press the OK button when the cup is filled to the desired level.

The serving size set will now be dispensed each time hot milk or milk froth is selected.

Programming can be canceled as long as CANCEL appears in the display.

Programming the amount using the SETTINGS menu

- Press and hold the OK button for two seconds.



- Turn the rotary control until PROG. THE AMOUNT appears in the display. Confirm with OK.
- Turn the rotary selector until the desired drink appears in the display. Confirm with the OK button.
- Turn the rotary selector until START appears in the display. Confirm with OK.

Preparation will begin and SAVE will appear in the display.

- Press the OK button when the cup has been filled to the desired level.

The serving size set will now be dispensed every time the selected drink is prepared.

SETTINGS Menu

The SETTINGS menu can be used to customize the coffee system to your preferences.

Options currently selected are marked with a check .

If a button has not been pressed for some time, the coffee system will revert to the main menu.

How to...	Action
Access the SETTINGS menu	In the main menu or standby mode, press and hold the OK button for two seconds.
Access an option	Turn the rotary selector in either direction until the desired option appears in the display. Confirm with OK.
Modify a setting	Turn the rotary selector in either direction until the desired setting appears in the display. Confirm with OK.
Exit the SETTINGS menu. Go back to the previous option. Go back to the previous menu.	Turn the rotary selection until BACK appears in the display. Confirm with OK.
Access the main menu or drinks selection menu	Press and hold the OK button for two seconds.

The factory default setting for each option appears **bold** in the following chart.

SETTINGS Menu

Options menu

Option	Available settings
Language	Deutsch (German), English and other languages
Maintenance	Rinse the system Descale Clean the brew unit
Time of day (available in Comfort mode)	Clock display 12 H / 24 H Set
Timer (available in Comfort mode)	Set switch on at / switch off after (1:00) / switch off at Activate switch on at (12:00) / switch off at (12:00)
Prog. the amount	Espresso Coffee Steam Hot water
Amount of coffee	Espresso mild / normal / strong Coffee mild / normal / strong
Pre-brewing	Yes / No
Temperature	Espresso low / normal / high Coffee low / normal / high
Operating mode	Eco-Mode Comfort-Mode
Automatic rinsing	On / Off
Info	Total portions Coffee Steam Hot water No. of portions until descaling
Water hardness	Soft 1 Medium 2 Hard 3 Very hard 4
System lock	On / Off
Cup warming	Yes / No
Factory default	Reset

The desired display language can be selected in the SETTINGS menu.

- Press and hold the OK button for two seconds.



- Turn the rotary selector until LANGUAGE  appears in this display. Confirm with OK.
- Turn the rotary selector until the desired language appears in this display. Confirm with the OK button.

The setting is now saved and the display will revert to the previous screen.

The display now appears in the set language.

If the wrong language has been selected by mistake, the LANGUAGE option can be found by following the  symbol.

Time of day and clock display

If the coffee system is being operated in Comfort Mode you can set the Time of day and the clock display in the SETTINGS menu.

The clock can be displayed in a 24 hour or 12 hour clock.

The time of day must be set in order for the timer to work, however it **will not** be visible in the display.

The time of day will not be saved if there is a power failure or if the machine is turned off using the main switch.

- Press and hold the OK button for two seconds.



- Turn the rotary selector until TIME OF DAY appears in the display. Confirm with OK.

The clock display and time of day can now be set.

Clock format

- Turn the rotary selector until CLOCK DISPLAY appears in the display. Confirm with OK.
- Turn the rotary control to the clock format desired, 12 H or 24 H.
- Confirm with OK.

The setting is now saved.

Setting the time of day

- Turn the rotary selector until SET appears in the display. Confirm with OK.
- Turn the rotary selector until the current hour appears. Confirm with OK.
- Repeat to set the minutes. Confirm with OK.

The setting is now saved.

The timer is only available if you are operating the coffee system in **Comfort Mode**.

The timer can be set so that the coffee system:

- turns on at a particular time (SWITCH ON AT).
- turns off at a particular time (SWITCH OFF AT).
- turns off after a particular length of time if none of the buttons have been pressed and no drinks have been prepared (SWITCH OFF AFTER).

The timer can only work correctly if:

- the time of day has been set.
- the coffee system is turned off via the On/Off button .
- the appropriate timer function has been activated (see "To activate and deactivate the timer").

After setting the "Switch on at" or "Switch off at" functions, they will need to be activated.

Setting the timer

- Press and hold the OK button for two seconds.



- Turn the rotary selector until TIMER appears in the display. Confirm with OK.
- Turn the rotary control until SET appears in this display. Confirm with OK.

You will now be asked to choose which timer function you would like to set.

Switch on at

The coffee system "Switch on at / Switch off at" functions will not operate if the system lock is activated.

- Turn the rotary selector until SWITCH ON AT appears in the display. Press the OK button.

You can now enter the hours and minutes.

- Turn the rotary selector until the desired hour setting appears in the display. Confirm with OK.

Timer

- Turn the rotary control until the desired minute setting appears in the display. Confirm with OK.

The setting is now saved. Once you have activated the timer function (see "To activate and deactivate the Timer"), the coffee system will turn on at the set time.

If the coffee system has turned itself on automatically three times and no drinks have been dispensed, the machine will not turn itself on again automatically. This will prevent the coffee system from turning on unnecessarily, for example if on vacation.

However the set times will remain in memory and be reactivated after manually turning the machine on again.

Switch off at

- Turn the rotary selector until SWITCH OFF AT appears in the display. Confirm with OK.

You can now enter the hours and minutes:

- Turn the rotary control until the desired hour setting appears in the display. Confirm with OK.
- Turn the rotary selector until the desired minute setting appears in the display. Confirm with OK.

The setting is now saved. Once you have activated the timer function (see "To activate and deactivate the Timer"), the coffee system will turn off at the set time.

Switch off after

If none of the buttons have been pressed and no drinks have been prepared after one hour the coffee system will turn itself off to save energy.

This time can be changed to another time ranging from 15 minutes to 9 hours.

- Turn the rotary selector until SWITCH OFF AFTER appears in the display. Confirm with OK.
- Turn the rotary selector until the desired hour appears in the display. Confirm with OK.
- Turn the rotary selector until the desired minutes appears in the display. Confirm with OK.

The setting is now saved. The coffee system will now turn itself off after the set time.

To activate and deactivate the timer

If the setting "Switch on at" has been activated, the  symbol will appear in the display when the coffee system is in Standby mode.

- Press and hold the OK button for two seconds.



- Turn the rotary selector until TIMER appears in the display. Confirm with OK.
- Turn the rotary selector until ACTIVATE appears in the display. Confirm with OK.
- Turn the rotary selector until SWITCH ON AT or SWITCH OFF AT (as desired) appears in the display. Confirm with OK.

The setting is now saved.

Default settings

The settings can be reset to the factory default settings as they were when the machine was first turned on.

Refer to the "Options menu" for the default settings marked in bold.

The following settings will not be reset:

- Language
- Time of day
- Number of drinks dispensed

- Press and hold the OK button for two seconds.



SETTINGS
< FACTORY DEFAULT >

- Turn the rotary selector until **FACTORY DEFAULT** appears in the display. Confirm with OK.
- Turn the rotary selector until **RESET** appears in the display. Confirm with OK.

The settings are now reset to the default.

The coffee system can be operated in either **Eco Mode** or in **Comfort Mode**.

When the coffee machine is operated in Eco Mode, the following will appear in the display while the machine is heating up:

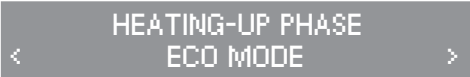

HEATING-UP PHASE
ECO MODE

The coffee system is preset with Eco Mode.

Eco Mode saves energy, the coffee system will switch to Standby mode if a drink has not been prepared for some time. The coffee system will heat up again when a button is pressed. The "Switch on at" and Switch off at" timer functions are not available in Eco Mode.

In **Comfort Mode** the coffee system will remain heated and all functions are available. The amount of energy used in Comfort Mode is higher than that used in Eco Mode.

To select the operating mode

- In the main menu, press and hold the OK button for two seconds.



SETTINGS
OPERATING MODE

- Turn the rotary selector until OPERATING MODE appears in the display. Confirm with OK.
- Turn the rotary selector until ECO-MODE or COMFORT MODE (as desired) appears in the display. Confirm with OK.

The setting is now saved.

System lock

The coffee system can be locked to prevent it from being used without your consent, e.g. by children.

Activating / Deactivating the system lock

If the system lock is activated the "Switch on at" option **will not** work. The  timer symbol will not appear in the display.

- Press and hold the OK button for two seconds.



- Turn the rotary selector until SYSTEM LOCK appears in the display. Confirm with OK.
- Turn the rotary selection until ON or OFF (as desired) appears in the display. Confirm with OK.

The setting is now saved.

When the system lock is activated, the coffee system will be locked as soon as it is turned off. Drinks cannot be dispensed.

Temporarily deactivating the system lock

- Press and hold the OK button for three seconds.

You are now able to prepare drinks.

Once the machine is turned off the system lock will be activated again and the coffee system will be locked again.

The INFO option can be used to check:

- the total number of portions of espresso, coffee, steam and hot water dispensed (TOTAL PORTIONS),
 - the number of portions of espresso and coffee dispensed (COFFEE),
 - how many times steam for hot milk and milk froth has been prepared (STEAM),
 - how many times hot water has been prepared (HOT WATER), and
 - the number of portions before descaling needs to be performed (No. PORTIONS UNTIL DESCALING).
- In the main menu, press and hold the OK button for two seconds.



- Turn the rotary selector until INFO appears in the display. Confirm with OK.
- Turn the rotary control until the desired option appears in the display. Confirm with OK.

The selected information will appear in the display.

To go back to the previous menu:

- turn the rotary selection until BACK appears in the display. Confirm with OK.

Cleaning and care

Quick guide

The coffee system must be cleaned every day to prevent a build-up of bacteria.

How often	Necessary cleaning
If it is going to be more than one hour before dispensing milk again	Rinse the cappuccinatore
Every day (after the last drink of the day is dispensed)	Wash the cappuccinatore
	Rinse the system
	Wash the water tank
	Wash the milk flask.
	Wash the waste container
Once a week	Wash the drip tray and cover
	Wash the brew unit
Approx. every 200 portions	Clean/degrease the brew unit (with cleaning tablets)
When prompted	Descal the coffee system
As necessary	Wash the bean container
	Cleaning the exterior (especially right after descaling)

Although some components of the coffee system are dishwasher safe, cleaning them in the dishwasher frequently can cause them to discolor. The surface may also become damaged.

Wash by hand only	Dishwasher safe
<ul style="list-style-type: none">– Brew unit– Drip tray– Coffee bean container lid– Cappuccinatore– Milk flask	<ul style="list-style-type: none">– Waste container– Drip tray cover– Water tank

Allow the coffee system to cool before cleaning. The water in the drip tray can be very hot. May cause burns!

Do not clean the unit with a steam cleaner.

Never use cleaners containing chlorides, sand, soda or scouring agents. These will damage the surface.

Rinsing the system

It is important to rinse the system daily to remove any coffee residues from the coffee system. The hot water from the rinsing process also pre-warms the pipework.

It is also important to rinse the system at the end of each day.

Turning the automatic rinsing On / Off

The pipework is rinsed automatically then the coffee system is turned off if this function is turned on, and the coffee system has prepared at least one drink since it was turned on.

The machine comes with this function turned on.

TIP It is recommended to keep this function turned on so that you do not forget to rinse the system.

- In the main menu, press and hold OK for two seconds.



- Turn the rotary selector until AUTOMATIC RINSING appears in the display. Confirm with OK.
- Turn the rotary selector to YES or NO (as desired). Confirm with OK.

The setting is now saved.

Cleaning and care

Rinsing the system manually

The system will need to be rinsed manually if the machine has been used and the automatic rinsing is turned off.

- Place a suitable container under the coffee dispensers.
- In the main menu, press and hold the OK button for two seconds.



- Turn the rotary selector until MAINTENANCE appears in the display. Confirm with OK.
- Turn the rotary selector until RINSE THE SYSTEM appears in the display. Confirm with OK.
- Turn the rotary selector until START appears in the display. Confirm with OK.

The piping will now be rinsed. The water from the rinsing process will flow from the coffee dispensers.



Cappuccinatore

The cappuccinatore can become clogged with milk residues, therefore it should be rinsed through if more than an hour has passed since it was last used to prepare milk.

Regardless it should be taken apart and cleaned daily.

Wash by hand using a mild solution of warm water and liquid dish soap.

Rinsing the cappuccinatore

- Place a container with some water next to the coffee system on the right hand side. Insert the milk tube into the water.
- Turn the cappuccinatore dial to the  or  symbol.
- Place a suitable container under the cappuccinatore.
- Press the  button.

Water will be drawn up through the milk tube and the cappuccinatore.

- When the cappuccinatore is thoroughly rinsed press the OK button.

Cleaning the cappuccinatore

Danger of burns. The cappuccinatore is very hot after use. Allow it to cool down before cleaning.

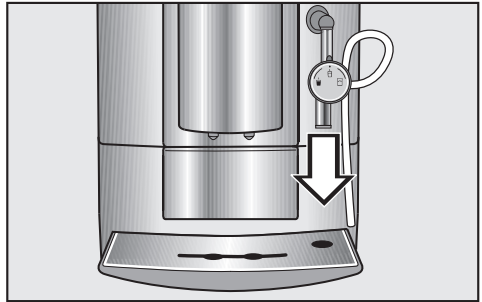

- Remove the cappuccinatore from the steam and hot water spout by pulling it downwards.

To separate the cappuccinatore parts:

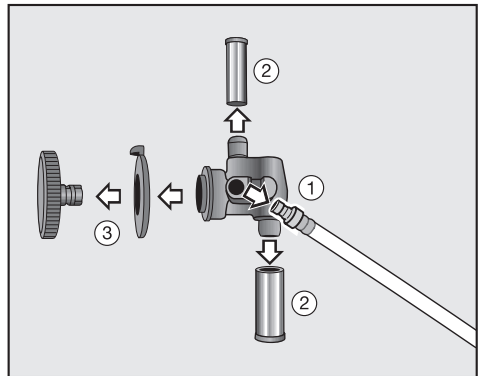

- Remove the milk tube ① and nozzles ②.
- Remove the dial and locking disc ③.

Cleaning and care

- Clean all the parts with a mild solution of warm water and liquid dish soap. If necessary a small soft brush can be used to remove stubborn soiling.
- Rinse all parts carefully and completely with water.
- Dry parts with a soft cloth.

Reassemble the cappuccinatore in the reverse order:

- First replace the locking disc, followed by the dial on the cappuccinatore.
- Then replace the milk tube and nozzles.
- Fit the cappuccinatore on to the steam and water spout from below.

Milk flask

The milk flask should be taken apart and cleaned daily.

The milk flask is not dishwasher safe, **wash by hand.**

- Pull the milk tube from the cappuccinatore. Disconnect the other end of the milk tube/stainless steel angle from the lid.
- Unscrew the lid and remove the stainless steel intake pipe on the lid.
- Wash all parts with a mild solution of warm water and liquid dish soap. If necessary use a small brush to remove stubborn milk residue.
- Rinse all parts with water.
- Thoroughly dry all parts.
- Put the milk container back together.

Water tank

The water should be changed everyday to prevent the build-up of bacteria.

Be sure that the valve, bottom of the water tank and the area under the water tank are clean and free of obstructions. Otherwise the water tank will not sit correctly.

- Wash the water container in the dishwasher, or by hand using a mild solution of warm water and liquid dish soap.
- Dry with a soft cloth.
- Clean the water tank niche, in particular the slots.

Drip tray cover

- Remove the cover from the drip tray.
- The cover can be cleaned in the dishwasher or with a mild solution of warm water and liquid dish soap.
- Dry with a soft cloth.

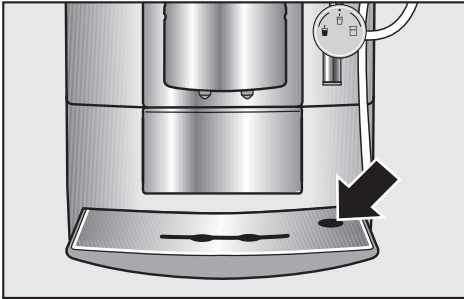

- Replace the drip tray cover. Be sure the outer hole is located under the cappuccinatore.

Drip tray and waste container

Clean the drip tray and waste container **everyday**.

The waste container is located in the drip tray.

The coffee system will display a message when the drip tray and/or waste container is full and needs to be emptied. This should be done when the message appears, if not sooner.

TIP If the rinsing process is in progress, wait a short time before removing the drip tray. Otherwise the water used in the rinsing process will run out of the coffee dispensers.

Cleaning and care

Drip tray

- Push the coffee dispensers up as far as they will go.



- Remove the drip tray together with the waste container by pulling the drip tray forward.
- Empty the drip tray and the waste container, if necessary.
- Wash the drip tray **by hand** with a mild solution of warm water and liquid dish soap. Wash the waste container (see "Waste container").
- Dry with a soft cloth.

Be sure the metal contacts on the drip tray are cleaned and dried properly. The discs will not be able to detect when the drip tray is full if they are dirty.

- Place the waste container back into the drip tray, push the assembly back into the machine.

Make sure the drip tray has been pushed into its niche as far as it will go.

Waste container

The waste container will usually contain some residual water from the rinsing process.

- Push the coffee dispensers up as far as they will go.
- Remove the drip tray together with the waste container by pulling the drip tray forward.
- Empty the waste container and the drip tray, if necessary.
- The waste container can be washed in the dishwasher or by hand using a mild solution of warm water and liquid dish soap. Wash the drip tray, if necessary (see "Drip tray").
- Dry the waste container with a soft cloth.
- Place the waste container back into the drip tray, push the assembly back into the machine.

Coffee bean container

Disconnect the coffee system from the electrical supply before cleaning.

- Open the lid on the right hand side of the coffee system. Remove the coffee bean container lid.
- Remove any coffee beans.
- Clean the bean container with a soft dry cloth.
- Refill it with whole roasted espresso or coffee beans.
- Replace the coffee bean container lid.

If necessary, clean the ground coffee chute.

- Open the lid of the ground coffee chute.
- Remove any ground coffee.

TIP A vacuum cleaner is an easy way to remove unwanted coffee grounds.

- Close the lid to the ground coffee chute.

Close the lid on the right hand side of the coffee system.

Brew unit

Rinse the brew unit **by hand only**. **Do not** use soap.

If the brew unit cannot be removed or it is difficult to do, the brew unit may not be in the correct position (see the "Frequently asked questions").

Note:

- The moving parts of the brew unit are lubricated, soap will wash away the lubrication causing damage to the brew unit.
- Clean the brew unit once per week.

Cleaning the brew unit

- To remove the brew unit pull out the two flaps on the right hand side of the coffee system. Turn the flaps 90° clockwise. Open the door.

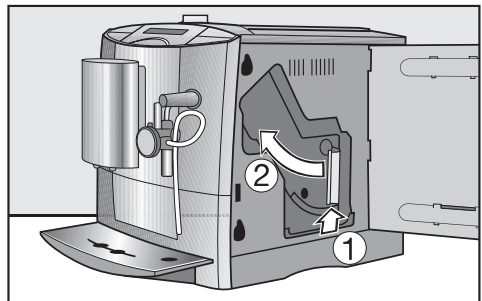

- Press the button under the handle of the brew unit ①, at the same time turn the handle to the counterclockwise ②.
- Carefully pull the brew unit out of the coffee system.

Cleaning and care

Do not move the brew unit handle, this could cause the brew unit to be out of alignment and you would be unable to fully push it back into the machine.

Clean the brew unit **by hand** under warm water **without soap**.

- Wipe away any coffee from the two filters. One filter is located in the funnel ①, the other is to the left of the funnel ②.

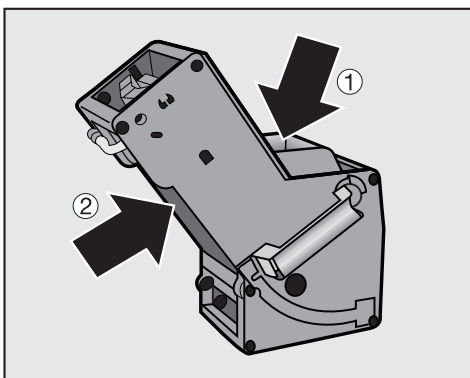

- Thoroughly dry the funnel area ①, to prevent coffee from sticking to it.
- Clean the inside of the coffee system. Use a vacuum to remove dry coffee grounds.

To replace the brew unit, repeat the previous steps in the reverse order:

- Push the brew unit back into the coffee system, making sure it is straight.

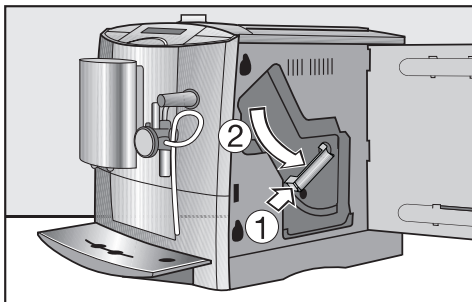

- Press the button on the handle of the brew unit ① at the same time turn the handle to the clockwise ②.
- Close the door. Turn the flaps 90° counterclockwise. Lower the flaps.

Cleaning/Degreasing the brew unit

Depending on the fat content of the coffee, the brew unit can clog. Clean the brew unit approx. every 200 cups with the enclosed detergent tablets. They are specially developed for the coffee maker to optimize the degreasing. The cleaning tablets can be purchased from Miele.

As a reminder the display shows CLEAN THE BREW UNIT after 200 portions have been dispensed and then count down until the machine is cleaned. The cleaning process takes about 10 minutes.

It is important to degrease the brew unit regularly.

- Press and hold the OK button for two seconds.



- Turn the rotary selector until MAINTENANCE appears in the display. Confirm with OK.
- Turn the rotary selector until CLEAN THE BREW UNIT appears in the display. Confirm with OK.
- Turn the rotary selector until START appears in the display. Confirm with OK.

Follow the instructions as prompted in the display to continue the cleaning program.

TIP Place a suitable container under the coffee dispensers, so that you do not have to continually empty the drip tray.

When DROP CLEANING TAB IN GROUND COFFEE CHUTE appears in the display:

- Open the lid on the right side of the coffee system.

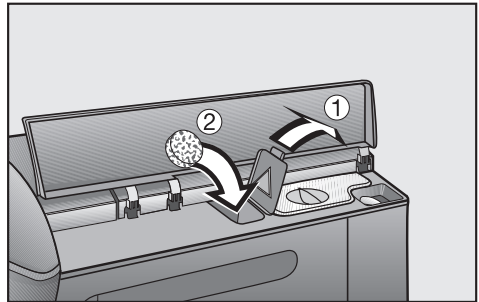

- Open the lid for the ground coffee chute ①. Place a cleaning tablet into the chute ②.
- Close the lids.
- Follow the instructions as prompted in the display.
- When PROGRAM FINISHED appears in the display, confirm with OK.

The brew unit is now degreased and drinks can be prepared.

Cleaning and care

Exterior

Remove any soiling as soon as possible. If not removed right away the surface of the machine could alter or discolor.

Be sure water does not get behind the display.

The exterior surfaces are susceptible to scratching. Contact with unsuitable cleaning agents could cause discoloration.

Clean any descaling agent splashes immediately.

- Turn the machine off using the  button.
- Clean the exterior with a soft, damp cloth and a mild solution of warm water and liquid dish soap.
- Dry with a soft cloth.

TIP A clean, damp micro fiber cloth can also be used to clean the exterior.

Avoid the following on all surfaces:

- cleaners containing soda, ammonia, thinners, or chlorides
- cleaners containing descaling agents or lime removers,
- abrasive cleaners,
- stainless steel cleaners,
- dishwasher soap (powders),
- caustic (oven) cleaners,
- scouring pads, steel wool, hard brushes,
- eraser sponges,
- metal scrapers.

Due to lime scale buildup the coffee system must be descaled regularly. How often, depends on the hardness of your local water supply.

The coffee system will remind you when a descaling program is needed. NO. PORTIONS UNTIL DESCALING: 50 will appear in the display. This number will then count down after each drink is prepared.

- Confirm the message with OK.

When 0 is reached the coffee system will lock. START THE DESCALING will appear in the display.

The descaling program **must** now be performed. The program takes approx. 20 minutes.

The coffee system can be turned off if you do not wish to perform the descaling program right now.

Regardless no more drinks will be prepared until the descale program is complete.

The display will guide you through the descaling procedure.

During the descaling program, water and descaling agent will run out of the steam and hot water spouts. This will be followed by a brief pause, then more agent will run from the machine.

- Press the OK button to start the descaling program.

The descaling program cannot be canceled once it has started.

- Turn the dial on the cappuccinatore to .

If the coffee system is hot, it will need to cool down for approx. 10 minutes before the descaling program can begin.

TIP Place a suitable container under the cappuccinatore, e.g. the waste container, so you do not have to empty the drip tray too frequently.

Descaling solution

Only use the **enclosed descaling tablets** for descaling. They are specially developed for the coffee system to optimize the descaling. The descaling tablets can be purchased from Miele. Other agents may damage the machine and affect the taste of coffee and hot water. The machine could also be damaged.

Follow the instructions on the descaling agent packaging closely. Be sure to fill the water container with enough water, using too little water can cause the descaling program to be stopped prematurely.

One descaling tablet will be needed to descale this machine.

- Fill the water container to the "0.5 l" mark with lukewarm water.
- Place one descaling tablet in the water.

Descaling

- Replace the water container in the coffee system.

When FILL WATER CONTAINER AND PLACE IN MACHINE appears in this display:

- remove the water tank and rinse it carefully with clean water. Be sure that no descaling agent is left in the water container. Fill the water container with cold, clean tap water up to the "Max." mark.

FINISHED will appear in the display when the descaling process has been completed.

- Confirm with OK.
- Wash the cappuccinatore to remove any descaling agent.
- Empty and wash the drip tray.
- Wash the water container.

The descaling program is now complete and drinks can be prepared.

When descaling the machine be sure to wipe away any splashes of descaling agent immediately. These could cause damage.

Selecting Descale via the MAINTENANCE menu

- In the main menu press and hold the OK button for two seconds.



- Turn the rotary selector until MAINTENANCE appears in the display. Confirm with OK.
- Turn the rotary selector until DESCALE appears in the display. Confirm with OK.
- Turn the rotary selector until START appears in the display.

The descaling program cannot be canceled once it has been started.

- Press the OK button.

Eco-Mode

When using Eco Mode the coffee system will save energy.

The coffee system will switch to Eco mode if it has not been used to prepare a drink in some time. When in Eco mode the heat function is not on constantly, therefore reducing energy usage.

The coffee system will heat up again when a drink is selected.

Pre-warming the cups with hot water

If you only need to pre-heat cups occasionally, the cup warming surface can be turned off.

Hot water from the cappuccinatore can be used to pre-heat the cups instead.

Turning off

If the machine will not be used for an extended period of time, turn it off using the main switch at the back of the machine.

Transport

If the coffee machine will not be used for an extended period of time, e.g. vacation, or will be transported over a long distance, the machine should be prepared in the following ways:

- Empty and clean the coffee bean container
- Empty and clean the water tank
- Evaporate the machine
- Clean the drip tray and waste container
- Pack the machine securely

Only pack the machine in a clean, dry environment. Coffee, milk and water residues can cause bacteria.

Evaporating the coffee system

The coffee system should be evaporated if being stored for a long period of time or transported any distance.

Evaporating the machine will remove all traces of water from the system, preventing water and frost damage.

- Turn the coffee machine Off using the  button.
- Empty the water tank.

TIP Place a suitable container, such as a coffee cup under the cappuccinatore.

- Press the OK button.
- Press the  button twice.

The evaporation process starts, the coffee system heats up and DRAIN THE SYSTEM appears in the display. The evaporation process is complete when the message goes out.

Caution! Hot steam will escape from the cappuccinatore, be careful of burns.

- When the display goes out, the evaporation process is complete.
- Turn the machine off using the main switch.
- Clean the drip tray and waste container.

The coffee system is now ready to be packed.

When you are ready to use the coffee system again it will need to be filled with water (see, "First steps to use").

Packing

Only pack the machine in a clean, dry environment. Coffee, milk and water residues can cause bacteria.

Use the original packaging including styrofoam to pack the coffee system. Keep the Operating Instruction manual in the box for future reference.

Frequently Asked Questions

 Repairs should only be carried out by a qualified and trained person in accordance with local and national safety regulations. Unauthorized repairs could cause personal injury or machine damage.

Do not open the outer casing of the coffee system.

Fault messages appear in the display

Fault - 1, Fault - 80 or Fault - 82

The coffee machine has overheated

- Turn the machine off with the On/Off button. Wait approx. one hour and then turn it on again.
- If the fault still appears, contact Miele Technical Service.

Fault - 28



There is too much coffee in the ground coffee chute.

If more than one level scoop is put into the ground coffee chute the brew unit cannot process it. The ground coffee will be directed into the waste container, and a Fault will appear in the display.

- Turn the coffee system off with the  button. Wait approx. two minutes and then turn it on again.

Fault - 73

The brew unit cannot be positioned correctly.

- Turn the coffee system off with the  button.
- Press the  and  buttons at the same time. Then press the OK button twice.

This will initialize the brew unit motor and put in back into the start position.

- If the fault appears again, contact Miele Technical Service.

Frequently Asked Questions

EMPTY THE DRIP TRAY appears in the display even though the drip tray is empty

The drip tray is not seated correctly.

- Push the drip tray into the coffee system into it clicks into place.

The metal contacts are dirty.

- Clean and dry the contacts.

or

- The drip tray sensor is not working correctly.
- Turn the coffee system off and then on again using the main switch.

If the fault still appears, contact Miele Technical Service.

Noises can be heard from the pump and FILL WATER CONTAINER AND PLACE IN THE MACHINE appears in the display.

The coffee system is trying to draw in water, even though the water tank is empty. Air is in the pipework.

- Fill the water tank with fresh, cold tap water.

The display will show SYSTEM FILLING UP - START.

- Confirm with the OK button.

Frequently Asked Questions

FILL WATER CONTAINER AND PLACE IN THE MACHINE appears in the display even though the water tank is full

The water tank is not seated correctly.

- Remove the water tank and then place it back into the niche.

If the fault message still appears

- empty the water container.

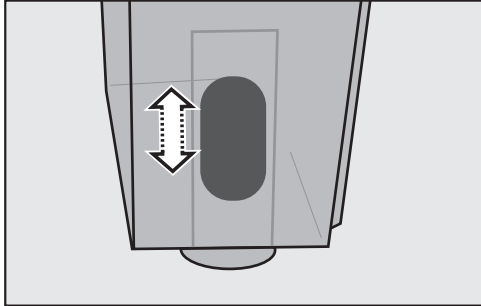

- Check to see that the float moves freely, by shaking the water tank.
- Fill the water container with fresh, cold tap water and replace it in the coffee system.

If the fault still appears, contact Miele Technical Service.

PROCESS STOPPED WATER CONT. EMPTY appears in the display and the dispensing stops

There is not enough water in the water tank.

- Fill the water container with fresh, cold tap water and replace it in the coffee system.
- Press the OK button.

CONTINUE DISPENSING -YES appears in the display.

- Press the OK button to continue dispensing, or select NO to cancel the preparation.

Frequently Asked Questions

Preparation / dispensing problems

Water is dispensed from the coffee dispensers when coffee has been selected

The ground coffee chute lid was opened and closed without coffee being put into it. YES was then selected when the GROUND COFFEE option appeared in the display.

- If ground coffee has not been added to the ground coffee chute, NO must be selected when prompted to use GROUND COFFEE.

Coffee beans have become stuck in the grinder

- Turn the coffee machine off with the main switch.
- Remove all coffee beans from the bean container.
- Add fresh beans.

Espresso or coffee flows into the cup too quickly

The coffee was ground too coarsely.

- Set the grinder to a finer setting (see "Adjusting the grinder setting").

Espresso or coffee flows too slowly into the cup.

The coffee was ground too finely.

- Set the grinder to a coarser setting (see "Adjusting the grinder setting").

Frequently Asked Questions

The coffee or espresso is not hot enough

The cup has not been pre-heated.	■ Pre-heat the cups (see "Pre-warming cups").
The brewing temperature is set too low.	■ Set a higher brew temperature (see "Brewing temperature").
The brew unit filters are blocked.	■ Clean the brew unit. ■ Clean/degrease the brew unit. See "Cleaning and care".

The crema on the coffee or espresso is "not right"

The grinder is not set correctly.	■ Set the grinder to a coarser or finer setting (see "Adjusting the grinder setting").
The brew temperature is too high for the type of coffee being used.	■ Set a lower brewing temperature (see "Brewing temperature").
The coffee beans are no longer fresh.	■ Add new beans to the coffee bean container.
The coffee dispensers are too high.	■ Pull the dispensers down until they are at the same height as the cup rim.

Frequently Asked Questions

General problems

When a drink is selected very little or nothing at all is dispensed from the coffee dispensers.

The brew unit filters are blocked.

- Clean/degrease the brew unit.
See "Cleaning and care".

Water has stopped flowing when programming the amount.

The maximum amount possible was reached. Preparation is stopped and the max. portion size possible is saved.

There is not enough water in the water tank. The programming process is canceled and the setting will not be saved.

- Fill the water tank with fresh, cold tap water and replace it in the niche.
- Repeat the programming procedure.

The machine does not rinse when turned on, even though the Automatic rinsing function is turned on.

This is not a fault.

If the coffee system still has an operating temperature higher than 140°F (60°C), the rinsing will not take place.

There is a lot of "coffee water" in the waste container.

The coffee is too coarsely ground.

- Set the grinder on a finer setting (see "Adjusting the grinder setting").
- Adjust the amount of coffee, if necessary (see "Adjusting the strength of the coffee").

Frequently Asked Questions

When the coffee system is turned on using the button the display remains dark.

The unit has no power.

- The main switch is turned off.
- The machine is not plugged in.
- Check that the fuse had not blown or is defective. If the fuse has blown contact Miele's Technical Service Department.

The coffee system turns off suddenly.

The programmed turn off time has been reached.

- If desired set a new turn off time (see "Timer").

The machine is not plugged in.

- Check the plug.

The coffee system does not turn on at the programmed and activated "Switch on at" time.

The system lock is activated.

- Deactivate the system lock. See "System lock".

The coffee system was not used after being turned on three times in a row automatically.

- Turn the machine on and prepare a drink.

Eco mode is activated.

- The timer function is not available in this mode.
- Select Comfort mode (see "Operating modes").

Frequently Asked Questions

The grinder is louder than usual

There could be pebbles within the coffee beans.



- Turn off the unit immediately.
- Contact Technical Service.

The coffee bean container has become empty during the grinding process.

- Fill with fresh beans.

The brew unit cannot be removed, or the brew unit cannot be replaced in the coffee system.

The brew unit or the brew unit motor is not in the correct position.

- Turn the machine off with the  button.
- Press the  and  buttons at the same time. Then press the OK button twice.

This will initialize the brew unit motor and the brew unit will move into the start position.

- If the brew unit can still not be removed or replaced in the machine, contact the Miele Technical Service Department.

The grinder control will not move.

The control is blocked.

- Reset the grinder setting while the grinding is in progress.

Frequently Asked Questions

The descaling program was started accidentally.

The descaling program cannot be canceled once the OK button has been pressed.

This is a safety measure to ensure that the machine is fully descaled. It is important for the long-term protection of the machine and to ensure that it functions properly.

- Complete the descaling program (see "Descaling".)

Loud noises are heard during the descaling program.

This is not a fault.

These noises occur when water is flushed through the machine at a high pressure.

The heating-up time is longer than usual, the amount of water being dispensed is not right and the coffee machine is not performing correctly.

The coffee system needs to be descaled.

- Descaling the coffee system (see, "Descaling").

Water is being sprayed above or is running out of the top of the cappuccinatore.

The cappuccinatore and steam tube are not connected securely.

- Remove the cappuccinatore by pulling it downwards.
- Turn the connecting piece very firmly onto the steam pipe.
- Push the cappuccinatore back onto the steam and water spout from below.

Milk is dripping from the cappuccinatore even though you are through dispensing milk.

The level of milk in the milk container is higher than the cappuccinatore.

- Turn the cappuccinatore dial to the ☞ position.

After sales service

Repairs

In the event of a fault which you cannot correct yourself please contact the Miele Service Department by phone number at the back of this booklet.

- Please quote the model type and number of your appliance.

These can be found on the data plate located behind the drip tray inside the coffee system.



Installation instructions

Information is subject to change. Please refer to our website to obtain the most current product specification, technical & warranty information.

Caring for the environment

Disposal of packing material

The cardboard box and packing materials protect the appliance during shipping. They have been designed to be biodegradable and recyclable. Please recycle.

Ensure that any plastic wrappings, bags, etc. are disposed of safely and kept out of the reach of children.
Danger of suffocation!

The original packaging can be used to transport the coffee system.

Disposal of an old appliance

Old appliances may contain materials that can be recycled. Please contact your local recycling authority about the possibility of recycling these materials.

Ensure that the appliance presents no danger to children while being stored for disposal. Before discarding an old appliance, unplug it from the outlet, cut off its power cord and remove any doors to prevent hazards.

All electrical work should be performed by a qualified electrician in strict accordance with national and local safety regulations. Installation, repairs and other work by unqualified persons could be dangerous.

Verify that the voltage, load and circuit rating information found on the data plate match the household electrical supply. This data must match to prevent damage to the coffee system. If in doubt, consult a licensed electrician.

The data plate can be found behind the drip tray inside the coffee system.

The plug will fit in the outlet only one way. If it does not fit, **DO NOT** use force and **DO NOT** modify the plug in any way. Contact a qualified electrician.

The socket should be located next to the machine and be easily accessible.

If the appliance is connected to the electrical supply with an extension cord please note:

- A short power-supply cord is to be provided to reduce risks resulting from becoming entangled in or tripping over a longer cord.
- Always use care and exercise caution with using an extension cord.
- The marked electrical rating of the extension cord should be at least as great as the electrical rating of the appliance.
- The extension cord should be a grounding-type 3-wire cord.

- A longer cord should be arranged so that it will not drape over the counter top or table top where it can be pulled on by children or tripped over.

Do not connect the appliance to a power inverter or directly to power produced outside of the normal electrical grid (i.e. direct solar or wind power source).

Direct connection to such power sources can cause power surges and tripped breakers when the appliance is turned on, and could damage the appliance.

Do not connect the appliance to energy saving plugs or outlets. The reduction of power to the appliance caused by these devices will cause the appliance to run hot and may damage it and/or shorten its usable life.

Do not operate any appliance with a damaged cord or plug. Contact Miele Technical Service.

If there is any question concerning the electrical connection of this appliance to your power supply, please consult a licensed electrician or contact Miele's Technical Service Department. See back page for contact information.

WARNING:
THIS APPLIANCE MUST BE GROUNDED

Installation

Danger of overheating!
Ensure that there is sufficient ventilation around the coffee system. Be sure the vents at the top of the machine are not covered completely.

Danger of overheating. If the coffee system is installed behind a cabinet door, it may only be used with the door open. Do not close the cabinet door while the coffee system is in use.

- Install the coffee system in a dry, well ventilated room.
- The ambient temperature should be between 50°F (10°C) and 90°F (32°C).
- The coffee machine should be installed on a water resistant, horizontal surface.
- Be sure the vents at the top of the machine are not covered completely, e.g. with a dish towel.

If the coffee machine is installed in a niche, the minimum dimensions of the niche are:

Height	20" (508 mm)
Width	17 11/16" (450 mm)
Depth	21 7/8" (555 mm)

- Position the coffee machine so that the front edge lines up with the front edge of the niche.

Dimensions

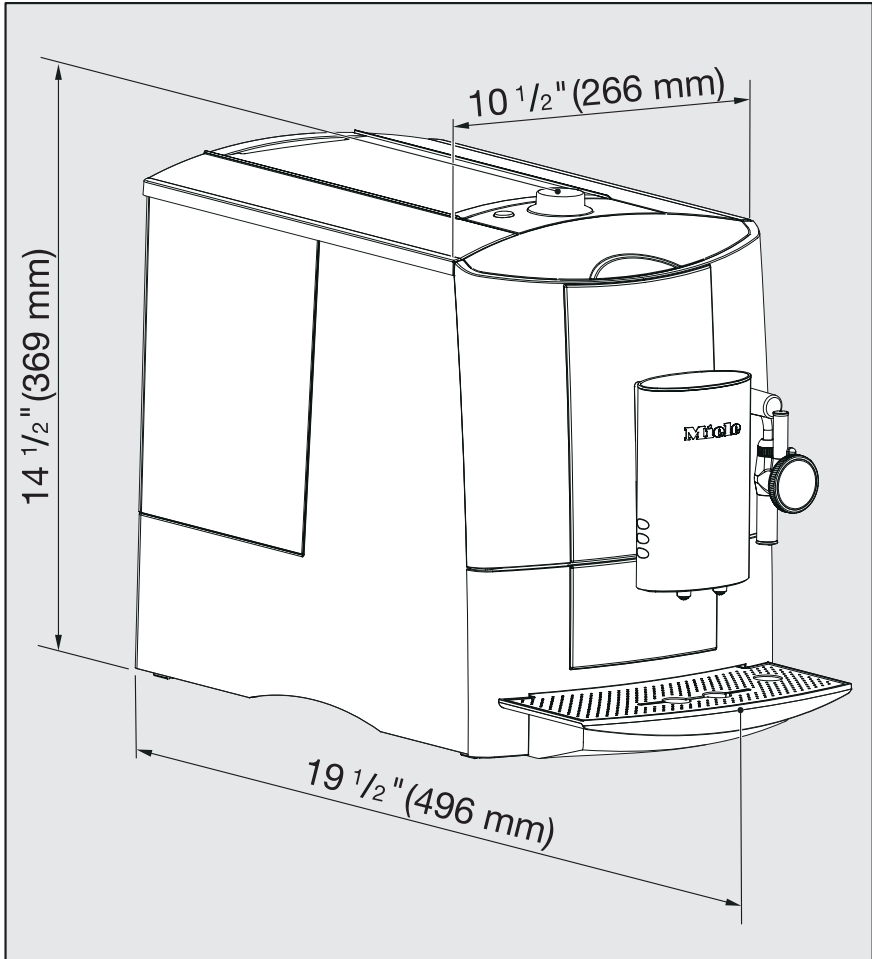

**Please have the model and serial number
of your appliance available before
contacting Technical Service.**



**U.S.A.
Miele, Inc.**

National Headquarters

9 Independence Way
Princeton, NJ 08540
Phone: 800-843-7231
609-419-9898
Fax: 609-419-4298
www.mieleusa.com

**Technical Service & Support
Nationwide**

Phone: 800-999-1360
Fax: 888-586-8056

TechnicalService@mieleusa.com

**Canada
Miele Limited**

Headquarters and Showroom

161 Four Valley Drive
Vaughan, ON L4K 4V8
Phone: 800-643-5381
905-660-9936
Fax: 905-532-2290
www.miele.ca
professional@miele.ca
(commercial enquiries)

MieleCare National Service

Phone: 800-565-6435
905-532-2272
Fax: 905-532-2292
customercare@miele.ca
(general and technical enquiries)

Germany

Miele & Cie. KG
Carl-Miele-Straße 29
33332 Gütersloh