

KRUPS

Espresso

Art. XP4050

www.krups.com

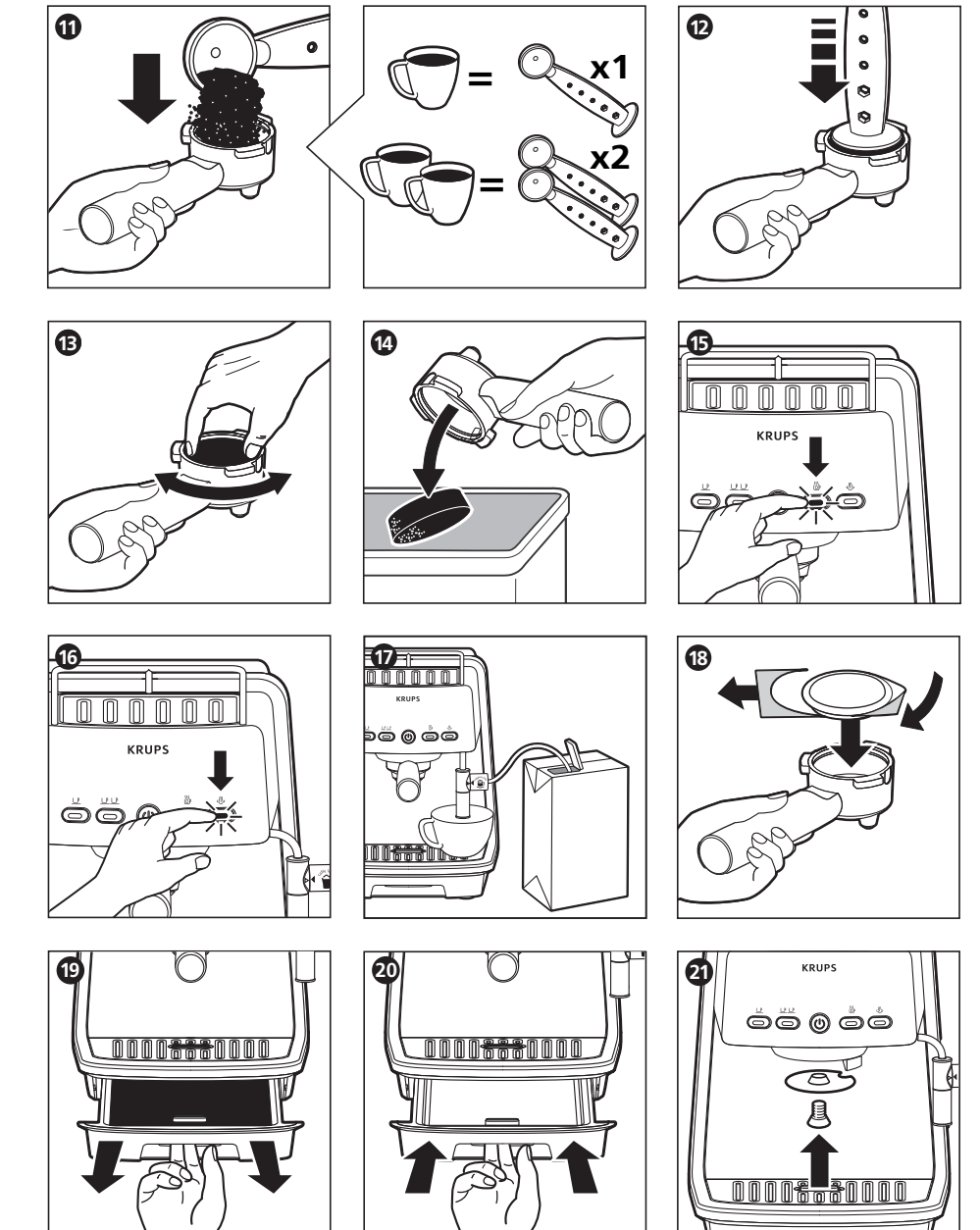
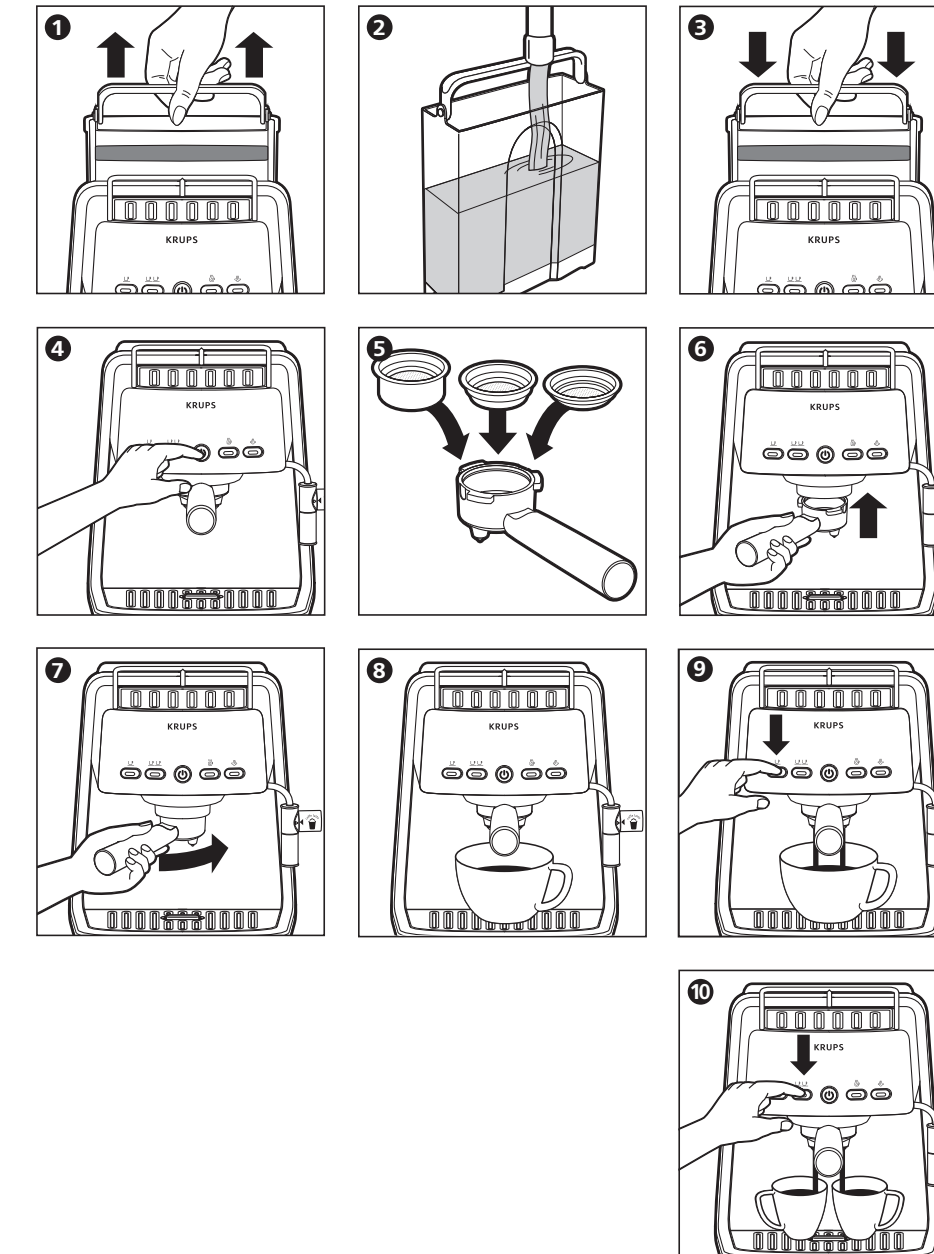
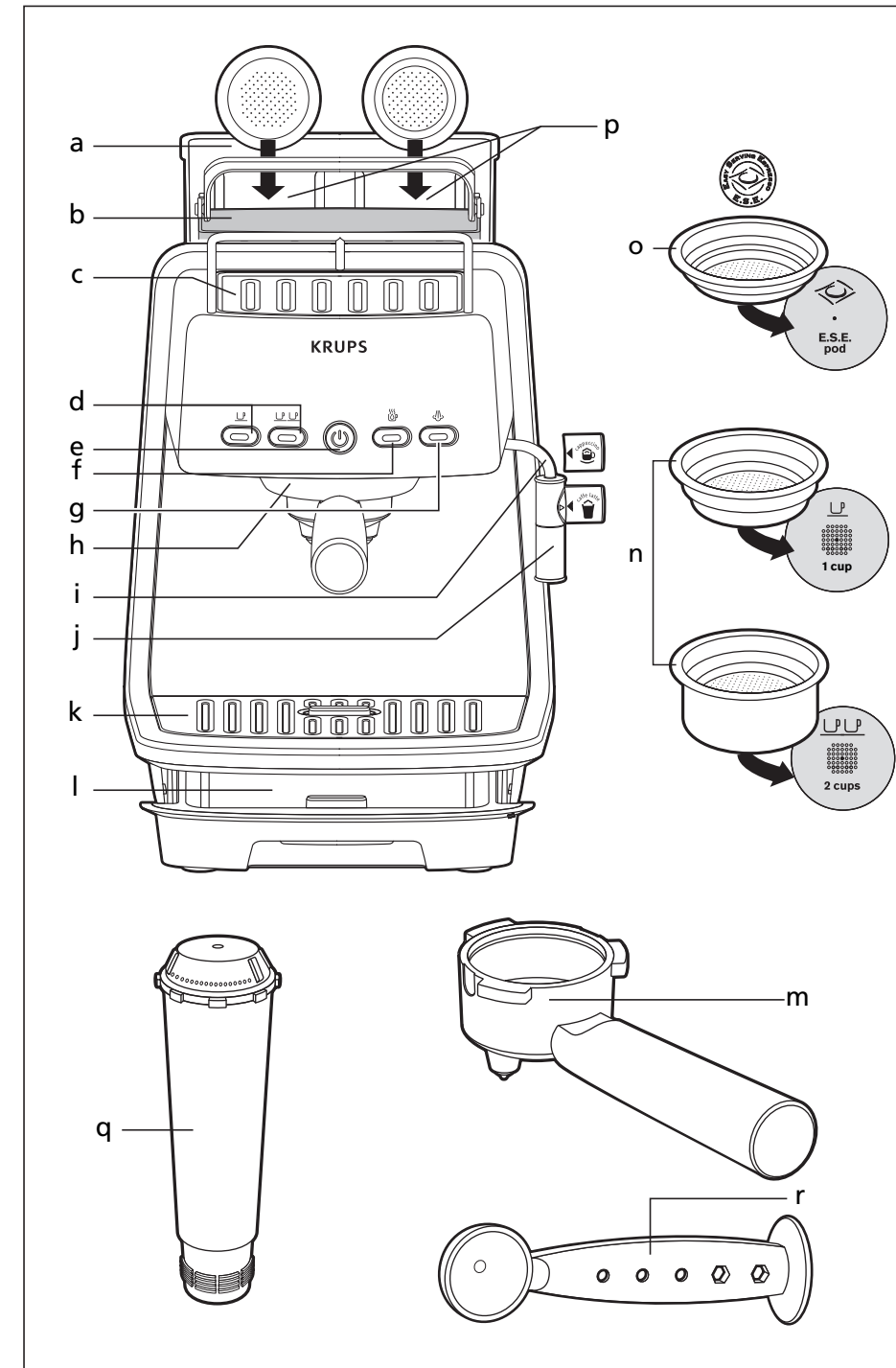

English

Description

a	Tank lid
b	Removable water tank
c	Warming plate for cups
d	Coffee buttons (☺, ☺☺)
e	Start / Stop switch with blue operating control lamp
f	Hot water button (☺☺)
g	Steam button (☺)
h	Brewing head
l	Steam nozzle
J	Auto cappuccino accessory
k	Grid
l	Drip tray
m	Filter holder
n	Filter for one or two cups (ground coffee)
o	ESE filter
p	Storage for filter sieves
q	Claris water filter*
r	Measuring spoon

* depending on model

Safety recommendations



- Please read these instructions carefully before first using your espresso. The appliance must only be connected to the mains via an earthed plug. Check that the voltage shown on the appliance's indicator plate corresponds to that of your electricity system.

It complies with the requirements of the EEC Directive (89/336/EEC) and (72/23/EEC).

- Never put your espresso on a hot surface (electric warming plate, for example) or close to a flame. Place on a flat, stable heat-resistant surface.
- Never remove the filter holder containing the coffee grounds while water is being passed through, since the appliance is under pressure at this time.

- Never use the appliance if the drip plate and the grid are not in position.
- Disconnect the electricity if there is any problem while the coffee is brewing or prior to cleaning your appliance.
- Never unplug the appliance by pulling on the cord and never lay the cord across a sharp edge or the corner of an item of furniture.
- Do not allow the cable or your hands to come into contact with the hot parts of the appliance (cup warming plate, filter holder, steam nozzle, cappuccino accessory).
- Never immerse the appliance in water.
- Keep away from children and do not allow the cord to hang down.
- Follow the instructions given for descaling.
- Never start the machine if it is damaged or if the cord is in poor condition.
- If the cord or any other specific part becomes defective, these can only be replaced by a Krups approved service centre. You must never, under any circumstances, open the appliance yourself, in order to avoid any danger.
- Check that the filter holder is firmly in position before starting the coffee and reset the selector to **O** before releasing the filter holder.
- Do not leave the appliance in the reach of unsupervised children - young children and severely handicapped persons must only use the appliance under the supervision of a responsible adult.
- This product has been designed for domestic use only. Any commercial use, inappropriate use or failure to comply with the instructions, the manufacturer accepts no responsibility and the guarantee will not apply.

Espresso coffee

Espresso coffee is richer in aroma and stronger than normal coffee. It is drunk from small pre-heated espresso cups. Hot water is passed through the ground coffee to obtain this delicious black coffee.

You can recognise an espresso by its characteristic aroma and its typical crema. But this requires high pressure and an excellent fresh espresso coffee which has been well roasted and correctly ground.

If you cannot buy espresso ground coffee, use a coffee grinder to grind the beans.

So as to obtain a sufficient crema with a good colour, it is normal that the flow rate of the coffee is slower than with a filter coffee machine.

To guarantee complete success for your espresso, you must also use freshly-drawn water (so that it has not had time to stagnate in the air), without any chlorine odour and at a fairly cold temperature.

The coffee must not be ground too fine. It must be slightly granulated. If it is too fine, you risk blocking the grid of the brewing head and the filter. Only use Espresso ground coffee. Do not use any other type of coffee such as filter, cafetiere, instant etc.

Before first using your machine

Before using your appliance for the first time, clean the water heating system, without coffee in the filter holder, filling the water tanks once or twice, as follows:

- Open the lid and lift out the water tank using the handle **(1)**. Fill with water **(2)**.
- Replace the tank, positioning it firmly to ensure that water can enter, and close the lid **(3)**.
- Press the Start/Stop switch **(4)** whereby the blue operating control lamp blinks. Two filters are kept in the tank lid.
- Place one of the filters in the filter holder **(5)**. Then put the filter holder on the appliance's brewing head.
- To ensure that the filter holder is in the correct position, turn the handle so it points to the left **(6)**, place the filter holder flat against the brewing head, then turn the handle towards the right **(7)** as far as it can go (may not be at right-angles).
- Place a container, as large as possible, beneath the filter holder **(8)**.

- As soon as the blue operating control lamp glows continuously,

The appliance is ready to operate.

- Pressing the double coffee button **☰☰ (10)** will now cause water to run through the water circuit.

Repeat this process five times.

As an optional extra, there is a filter cartridge available (N° art. F088 not delivered with the appliance).

Using the various functions of your espresso machine

1. MAKING AN ESPRESSO

.WITH ESPRESSO GROUND COFFEE

For best results, we recommend that you first **pre-heat the accessories** (filter holder, filter and cups) **without putting in ground coffee**. To do this :

- Fill the water tank **(1) (2) (3)** and start the appliance **(4)**.
- Put the filter holder in place **(6) (7)**, and place one or two cups underneath.
- As soon as the control lamp on the coffee buttons glows continuously, the appliance is ready to operate.
- Press the coffee keys **☰** or **☰☰ (9) (10)**.
- The cups will be filled with hot water then empty them.

Once the appliance is hot, the espresso cups can then be pre-heated on the cup warming plate.

. Preparing an espresso :

- Fill the water tank **(1) (2) (3)** and start the appliance **(4)**.
- Put the filter for one or two cups into the filter holder **(5)**.
- Put one or two measures of ground coffee into the filter with the measuring spoon and tamp down using the measuring spoon **(11) (12)**.
- Remove any ground coffee which is lying around the filter **(13)**.
- Replace the filter holder **(6) (7)**.

- Place one or two espresso cups beneath the filter holder.

As soon as the control lamp on the coffee buttons glows continuously, the appliance is ready to operate.

Your appliance is already preprogrammed for the preparation of one or two cups of espresso.

- Pressing the coffee keys **☰** or **☰☰** **(9) (10)**.
- At the beginning, there is a pre brewing time lasting 2 or 3 seconds.
- When the programmed quantity is reached, the espresso stops running automatically.
- Remove the filter holder and the filter from the machine and take out the coffee grounds **(14)**.

The filter can be refilled to make more espressos.

. WITH THE SPECIAL «ESE» FILTER

The E.S.E. system was designed for making Italian-style espresso ristretto (squeezed). The amount of coffee is 35 ml and the water should take 20 seconds to run through. (see Individual Programming to adjust volume)

«ESE», which stands for «**E**asy **S**erving **E**spresso», is a selected measure of coffee, ground and pressed between two filter papers making it ready for use. This system makes it easy for you to prepare your espresso because you avoid the measurement and tamping down operations and it also makes it easier for you to clean the appliance.

We do not intend, or recommend, that the ESE servings are used for making a long coffee.

We recommend that you take care, when handling and storing the ESE servings, that they do not become deformed.

For best results, we recommend that you pre-heat the accessories (filter holder, filter and cups) without any coffee. Do this as described in the Making an Espresso using Espresso Ground Coffee section.

. Preparing an espresso:

- Fill the water tank **(1) (2) (3)** and start the appliance **(4)**.
- Place the ESE serving in the ESE filter **(18)**.

Tear excess paper from the pod at the perforated edge. Place the ESE pod with the RED MARKING FACE DOWN (bend the paper corners down).

- Take care to put all the paper inside the filter to avoid any drips.

Placing the ESE pod correctly will create a richer, thicker crema.

- Put the filter holder in place **(6) (7) (8)** by pressing it firmly to the right.



As soon as the control lamp on the coffee buttons glows continuously, the appliance is ready to operate.

- Press the coffee key **☰** **(9)**.
- At the beginning, there is a pre-brewing time lasting 2 or 3 seconds.
- When the recommended quantity of coffee has been reached (35ml), press the coffee button **☰** **(9)** if suitable volume was not preprogrammed.
- Remove the filter holder from the brewing head and throw away the used measure.

. Individual Programming:

Should you wish to alter the preprogrammed quantity (50ml per cup, manufacturing setting) of hot espresso filled into one or two cups, proceed as follows:



- Fill the water tank **(1) (2) (3)** and start the appliance **(4)**.
- Put the filter for one or two cups into the filter holder **(5)**.
- Put one or two measures of ground coffee into the filter with the measuring spoon and tamp down using the measuring spoon **(11) (12)** or a ESE pod in the ESE filter **(18)**.
- Remove any ground coffee which is lying around the filter **(13)**.
- Replace the filter holder **(6) (7)**.
- Place one or two cups beneath the filter holder.
- As soon as the control lamp on the coffee buttons glows continuously, the appliance is ready to operate.
- Hold down either the one or two cups key **☰** or **☰☰** **(9) (10)** (for at least 3 sec) , the two lamps (coffee key and operating control) blink.

When the desired quantity of espresso has run through, you stop by pressing the coffee key  or  (9) (10).

Now the quantity is automatically memorized.

. Hot Water Preparation

You can prepare hot water with this appliance.

- Fill the water tank (1) (2) (3) and start the appliance (4).
- Place the cup beneath the auto cappuccino accessory.
- As soon as the control lamp on the hot water button glows continuously, the appliance is ready to operate.
- Pressing the hot water button  (15).
- When the desired quantity of water has run through, you stop by pressing the hot water key  (15).

2. STEAM FUNCTION

The tapping noise which occurs while steam is being produced comes from the intermittent operation of the pump and has no effect on the proper working of the appliance.





Beware: during and after use of the machine, the metallic parts of the auto cappuccino accessory can become burning hot.

. Using the auto cappuccino accessory

The auto cappuccino accessory makes it easy to produce frothy milk for making a cappuccino, a latte or a hot chocolate.

- Fill the water tank (1) (2) (3) and start the appliance (4).
- Put the auto cappuccino accessory in place on the steam nozzle.
- Place a cup under the auto cappuccino accessory.
- Pour about 100 ml of very fresh, very cold milk into a container. The milk and its container must be well chilled.
- Insert the flexible tube into this container or directly into the milk carton (17).

Please note the straight cut end of tube must fit inside auto cappuccino device and the irregular end dipped in milk.

- Turn the setting knob to the position “cappuccino” or “latte”.
- When the appliance is ready (operating control lamp glows continuously), press the steam button  (16), the operating control lamp blinks.
- When the control lamp of steam button glows continuously again, appliance is ready for steam.
- Press the steam button  (16).
- Once the froth has been produced, stop by pressing the steam button  (16) for the following cleaning operation in order to prevent the milk from drying on the auto cappuccino accessory.
- Place a cup under the auto cappuccino accessory.
- Immerse the flexible tube into a clean container 1/3 full of water.
- Press the steam button  (16) and when all the water has run through, press the steam key  (16) to stop.
- Next, clean the auto cappuccino accessory with a damp cloth.

For more thorough cleaning of the auto cappuccino accessory, please refer to the paragraph on maintenance.

. Hot chocolate

- Repeat the same procedure as below after changing the milk with a chocolate beverage you want to heat up.
- If your espresso machine is ready for steam - for 5 min without use, the appliance switches automatically to coffee stand by.

If you wish to make an espresso immediately after steam, the appliance must first be allowed to cool down in order to achieve the correct temperature for preparing an espresso.

- Appliance automatically cools down when pressing the coffee button (one or two cups) - When cooling down, the blue operating control blinks and hot water flows into drip tray. When correct temperature is reached, appliance will run espresso cycle.

- If your espresso machine runs short of water, a sonor signal and all leds blinking incite you to fill the water tank.
- Your espresso machine switches to stand by mode after 30 mn for energy saving and switches off after 1H 30 of none use.

Maintenance

- Never wash your espresso machine accessories in the dishwasher.

After use, the water tank must be emptied.

. Drip tray

This must be emptied after using the appliance after taking off the grid **(19)**. If several espressos are being prepared one after the other, the drip tray should be emptied from time to time (about once every 7 - 8 espressos). The presence of water is normal and does not signify a leak. If necessary, clean the drip tray and its grid with water and a little non-abrasive washing-up liquid, rinse and dry. Replace it correctly **(20)**.

. The brewing head, the filter and the filter holder

These must be cleaned after each use. All you need to do is wipe a damp cloth over the brewing head of your appliance and to wash the other accessories in water and a little non-abrasive washing-up liquid, rinse and dry.

If the brewing head is heavily clogged up, unscrew the grid, clean it and refit it, pressing down firmly **(21)**.

When your espresso is not being used, do not leave the filter holder on the appliance to prevent wear on the gasket.

. **The cup warming plate:** remove this to clean it with water and a little non-abrasive washing-up liquid, rinse and dry.

. The auto cappuccino accessory

For more thorough cleaning the auto cappuccino accessory can be dismantled from the appliance.

Clean it with water, a little non-abrasive washing-up liquid and a small brush. Rinse and dry it before refitting it.



Please note the direction of fitting the flexible tube : engage the straight-cut end in the auto cappuccino Accessory.

Descaling

- Descaling of your espresso should be done fairly frequently with citric or tartaric acid.
- Due to the acid substance, we recommend protecting your worktop and sink unit during the descaling process, especially if it is made of marble or stone. Isolate your espresso with a tea towel, a tablecloth or a tray.

However, we would advise you to use the **Krups descaling accessory, reference F054**, which is available from Krups after-sales service centres. This accessory includes, apart from two descaling doses, a testing strip for water hardness to assess the frequency of descaling of your appliance in normal use. Descaling depends on the hardness of the water, but also on the use cycle. The frequency of descaling indicated by the **F054** accessory is thus given by way of indication only.

- Then follow the following method:

- Unscrew the grid from the head of the appliance and clean it **(21)**.
- Dissolve a sachet of KRUPS descaling accessory, reference F054, in half a litre of lukewarm water and pour the whole amount into the empty water tank.
- start the appliance **(4)**.
- Place a container, as large as possible, beneath the auto cappuccino accessory.
- As soon as the blue operating control lamp glows continuously, the appliance is ready
- Pressing the hot water button  **(15)**, run through 1/3 of the liquid.
- Then, pressing the hot water button  **(15)** to stop.
- Move the container under the brewing head.
- Run the second third of the liquid immediately by pressing the coffee button  **(10)** as many times as necessary.

- Stop the appliance by pressing the start/stop switch **(4)** and wait for 10 - 15 minutes to allow the descaler to take effect.
- Next, start the machine again **(4)** and allow the rest of the liquid to run through by pressing the coffee button **☺☺ (10)** as many times as necessary.
- Then rinse with two water tanks of fresh water, clean the brewing head and replace the grid on the head of the appliance (see paragraph on maintenance).
- **The guarantee does not include espresso machines which do not function, or do not function properly, because descaling has not been carried out.**

Problems, probable causes and how to correct them

Problems	Probable causes	Corrective actions
Espresso not hot enough	Cups, filter and filter holder are cold.	Preheat the accessories (cups, filter, filter holder) See paragraph «Preparing an espresso».
Coffee leaks around the filter holder	The filter holder is not mounted correctly or has not been tightened sufficiently.	See paragraph «Preparing an espresso».
	There are coffee grounds on the edge of the filter	Clean around the filter and the gasket.
	The brewing head gasket is dirty.	Clean the gasket with a damp cloth.
	The brewing head gasket is defective	Contact an approved Krups service centre.
Pump is very noisy	No water in the water tank.	Fill the water tank.
	Water tank incorrectly mounted.	Press firmly down on the water tank.
	Coffee grounds too old or very dry and the pump cannot produce pressure.	Use fresh coffee

Water does not run through.	No water in the water tank.	Fill the water tank.
	Water tank incorrectly mounted.	Press firmly down on the water tank.
	The filter is blocked, the coffee grounds are too fine or tamped down too hard.	Clean the filter and the grid on the brewing head. See the paragraph «Maintenance» and try a coarser coffee.
	Brewing head grid is encrusted.	Put the grid to soak in descaling solution See paragraph «Maintenance».
Water runs through too quickly.	Appliance needs descaling.	See paragraph «Descaling».
	Coffee grounds too coarse.	Try a finer coffee
	Quantity of ground coffee is insufficient.	Use the spoon provided to measure out the coffee.
The espresso has no crema (froth on coffee).	Coffee grounds not tamped down firmly enough.	Tamp down the coffee again.
	Coffee grounds too coarse.	Try a finer-ground coffee.
The milk is not very frothy.	Coffee grounds not tamped.	Tamp down the coffee again.
	Coffee grounds stale or too dry.	Use fresh coffee.
	Auto Cappuccino accessory blocked	See paragraph «Maintenance»
Lots of water on the coffee grounds.	Milk not fresh.	Use fresh milk.
	Milk is lukewarm.	Put milk in refrigerator.
	Milk is not suitable.	Try another brand.
	Grounds not properly tamped down.	Tamp down the grounds.
	Insufficient quantity of ground coffee.	Increase the quantity of ground.

If you have any product problems or queries, please contact our Customer Relations Team first for expert help and advice :

0845 602 1454 - UK

(01) 4751947 - Ireland

or consult our website - www.krups.co.uk

Recipes

Savour your espresso just as you like it: when you want to relax or to round off a good meal.

Here are a few recipes which you will be able to create with your espresso machine.

. Original espresso

- Take one measuring spoonful of good quality well roasted espresso coffee, and filter it directly into the pre-heated cup.

If you use good, finely ground espresso coffee, the cup will be crowned by a fine head of froth.

- Add sugar if desired and treat yourself. Original espresso is drunk without milk but plenty of sugar.

. Cappuccino

For a state of the art cappuccino, the ideal quantities are as follows: 1/3 coffee, 1/3 hot milk, 1/3 frothy milk. The quantity of hot milk + froth obtained should be about double the amount of coffee prepared.

- Use large cups which have been pre-heated.
- Fill them with coffee to the equivalent of one cup of espresso and top up with milk which has been frothed up using the auto cappuccino accessory.
- Lastly, sprinkle with drinking chocolate powder.

. Café crème

- Prepare a classic espresso in a large cup.
- Add a cloud of cream to make an espresso with milk.

You can also replace the cream with hot milk.

. Caffè corretto *

- Prepare a cup of espresso in the normal way.
- Then slightly 'correct' the taste by adding 1/4 or 1/2 a glass of cognac.

You can also use anisette, grappa, Sambuco, Kirsch or Cointreau for the same effect.

And there must be countless other possibilities for «enriching» an espresso. Let your imagination run wild.

. Coffee Liqueur *

- Mix in an empty 0.75 litre bottle: 3 cups of espresso, 250 g brown cane sugar, 1/2 litre cognac or Kirsch.
- Leave the mixture to soak for at least 2 weeks.

You will then have a delicious liqueur, especially for coffee lovers.

. Iced coffee à l'italienne

4 vanilla ice cubes, 2 cups of cold sugared espresso, 1/8 litre milk, fresh cream, grated chocolate.

- Mix the cold espresso with milk.
- Distribute the ice cubes among the glasses, pour the coffee over them and decorate with fresh cream and grated chocolate.

. Friesian coffee *

- Add a small glass of rum to a sugared cup of espresso.
- Decorate with a good layer of fresh cream and serve.

. Espresso flambé*

2 cups of espresso, 2 small glasses of cognac, 2 teaspoonfuls of brown sugar, fresh cream.

- Pour the cognac into heat-resistant glasses, heat and flame.
- Add sugar, mix, pour the coffee and decorate with fresh cream.

If you like, the espresso can also be diluted with a little boiling water.

. Perfect espresso *

2 cups of espresso, 6 egg yolks, 200g sugar, 1/8 litre sugared fresh cream, 1 small glass of orange liqueur.

- Beat the egg yolks with the sugar until it forms a thick foamy mass.

- Add the cold espresso and orange liqueur.
- Then mix in the fresh whipped cream.
- Pour the mixture into cups or glasses.
- Put the cups into the freezer.

(* : The abuse of alcohol is dangerous to your health).



Environment protection first!

- ① Your appliance contains valuable materials which can be recovered or recycled.
- ➔ Leave it at a collection point.