



THE  
**DEFENDER**<sup>®</sup>

V15 & 15H

**GUITAR AMPLIFIERS**

OWNER'S MANUAL



## **Congratulations on the purchase of your Kustom Defender Amplifier.**

Your Defender Model draws on decades of amp design and manufacturing experience at Kustom. This model was built from the ground up to offer world-class tone, useful features and reliable performance. Inside this manual, you'll find valuable information about the amp's controls and specifications. Being familiar with its features will help you effectively dial in different tones. We wish you many years of enjoyment with your Kustom amplifier.

## FCC Statements

1. Caution: Changes or modifications to this unit not expressly approved by the party responsible for compliance could void the user's authority to operate the equipment.

2. Note: This equipment has been tested and found to comply with the limits for a Class B digital device, pursuant to Part 15 of the FCC Rules. These limits are designed to provide reasonable protection against harmful interference in a residential installation. This equipment generates, uses, and can radiate radio frequency energy and, if not installed and used in accordance with the instructions, may cause harmful interference to radio communications. However, there is no guarantee that interference will not occur in a particular installation. If this equipment does cause harmful interference to radio or television reception, which can be determined by turning the equipment off and on, the user is encouraged to try to correct the interference by one or more of the following measures:

- Reorient or relocate the receiving antenna.
- Increase the separation between the equipment and receiver.
- Connect the equipment into an outlet on a circuit different from that to which the receiver is connected.
- Consult the dealer or an experienced radio/TV technician for help.

# ENGLISH

## Danger

Exposure to extremely high noise levels may cause a permanent hearing loss. Individuals vary considerably to noise induced hearing loss but nearly everyone will lose some hearing if exposed to sufficiently intense noise for a sufficient time.

The U.S. Government's Occupational Safety and Health Administration (OSHA) has specified the following permissible noise level exposures:

DURATION PER DAY (HOURS)	8	6	4	3	2	1
SOUND LEVEL (dB)	90	93	95	97	100	103

According to OSHA, any exposure in the above permissible limits could result in some hearing loss. Ear plugs or protectors in the ear canal or over the ears must be worn when operating this amplification system in order to prevent a permanent hearing loss. If exposure in excess of the limits as put forth above, to insure against potentially harmful exposure to high sound pressure levels, it is recommended that all persons exposed to equipment capable of inducing high sound pressure levels, such as this amplification system, be protected by hearing protectors while this unit is in operation.

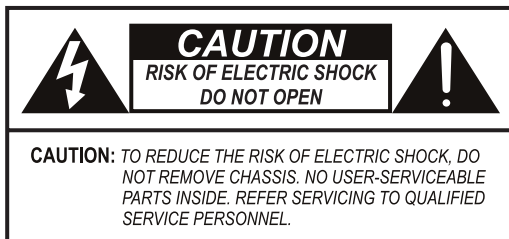

**AVIS: RISQUE DE CHOC ELECTRIQUE-NE PAS OUVRIR.**



THIS SYMBOL IS INTENDED TO ALERT THE USER TO THE PRESENCE OF NON-INSULATED "DANGEROUS VOLTAGE" WITHIN THE PRODUCT'S ENCLOSURE THAT MAY BE OF SUFFICIENT MAGNITUDE TO CONSTITUTE A RISK OF ELECTRIC SHOCK TO PERSONS.



THIS SYMBOL IS INTENDED TO ALERT THE USER TO THE PRESENCE OF IMPORTANT OPERATING AND MAINTENANCE (SERVICING) INSTRUCTIONS IN THE LITERATURE ACCOMPANYING THE UNIT.



APPARATUS SHALL NOT BE EXPOSED TO DRIPPING OR SPLASHING AND THAT NO OBJECTS FILLED WITH LIQUIDS, SUCH AS VASES, SHALL BE PLACED ON THE APPARATUS.

## IMPORTANT SAFETY INSTRUCTIONS

1. Read all safety and operating instructions before using this product.
2. All safety and operating instructions should be kept for future reference.
3. Read and understand all warnings listed on the operating instructions.
4. Follow all operating instructions to operate this product.
5. This product should not be used near water, i.e. Bath tub, sink, swimming pool, wet basement, etc.
6. Only use dry cloth to clean this product.
7. Do not block any ventilation openings, It should not be placed flat against a wall or placed in a built-in enclosure that will impede the flow of cooling air.
8. Do not install this product near any heat sources ;such as,radiators, heat registers, stove or other apparatus (including heat producing amplifiers) that produce heat.
9. Do not defeat the safety purpose of the polarized or grounding-type plug. A polarized plug has two blades with one wider than the other.A grounding-type plug has two blades and a third grounding prong. The wide blade or the third prong are provided for your safety If the provided plug does not fit into your outlet, consult an electrician for replacement of the obsolete outlet.
10. Protect the power cord being walked on or pinched, particularly at Plugs, convenience receptacles and the point where they exit from the apparatus. Do not break the ground pin of the power supply cord.
11. Only use attachments specified by the manufacturer.
12. Use only with the cart, stand, tripod, bracket, or table specified by the manufacturer or sold with the apparatus. When a cart is used, use caution when moving cart/ apparatus combination to avoid injury from tip-over. 
13. Unplug this apparatus during lightning storms or when unused for long periods of time.
14. Care should be taken so that objects do not fall and liquids are not spilled into the unit through the ventilation ports or any other openings.
15. Refer all servicing to qualified service personnel. Servicing is required when the apparatus has been damaged in any way; such as, power-supply cord or plug is damaged, liquid has been spilled or objects have fallen into the apparatus, the apparatus has been exposed to rain or moisture, does not operate normally or has been dropped.
16. **WARNING:** To reduce the risk of fire or electric shock, do not expose this apparatus to rain or moisture.
17. When the MAINS plug, or an appliance coupler, is used as the disconnect device, the disconnect device shall remain readily operable.

# FRENCH

## Danger

L'exposition a des niveaux eleves de bruit peut provoquer une perte permanente de l'audition, Chaque organisme humain reagit differemment quant a la perte de l'audition, mais quasiment tout le monde subit une diminution de l'acuite auditive lors d'une exposition suffisamment longue au bruit intense. Les autorites competentes en reglementation de bruit ont defini les expositions tolerees aux niveaux de bruits:

DURE EN HEURES PAR JOUR	8	6	4	3	2	1
INIVEAU SONORE CONTINU EN dB	90	93	95	97	100	103

Selon les autorites, toute exposition dans les limites citees ci-dessus, peuvent provoquer certaines pertes d'audition. Des bouchons ou protections dans l'appareil auditif ou sur l'oreille doivent etre portes lors de l'utilisation de ce systeme d'amplification afin de prevenir le risque de perte permanente de l'audition, Dans le cas d'expositions superieures aux limites precitees il est recommande, afin de se premunir contre les expositions aux pressions acoustiques elevees potentiellement dangeureuses, aux personnes exposees aux equipements capables de delivrer de telles puissances, tels ce systeme d'amplification en fonctionnement, de proteger l'appareil auditif.



CE SYMBOLE A POUR BUT D'AVERTIR L'UTILISATEUR DE LA PRESENCE DE VOLTAGE DANGEREUX NON-ISOLE A L'INTERIEUR DE CE PRODUIT QUI PEUT ETRE DE PUISSANCE SUFFISAMMENT IMPORTANTE POUR PROVOQUER UN CHOC ELECTRIQUE AUX PERSONNES.



CE SYMBOLE A POUR BUT D'AVERTIR L'UTILISATEUR DE LA PRESENCE D'INSTRUCTIONS D'UTILISATION ET DE MAINTENANCE DANS LES DOCUMENTS FOURNIS AVEC CE PRODUIT.



AFIN DE REDUIRE LES RISQUÉ D'INCENDIE ET DE DECHARGE ELECTRIQUE, NE PAS EXPOSER CET APPAREIL A LA PLUIE OU A L'HUMIDITE.

## IMPORTANTES INSTRUCTIONS DE SECURITE

1. Lire avec attention toutes les recommandations et precautions d'emploi avant d'utiliser ce produit.
2. Toutes les recommandations et precautions d'emploi doivent être conservées afin de pouvoir s'y reporter si nécessaire.
3. Lire et comprendre tous les avertissements énumérés dans les precautions d'emploi.
4. Suivre toutes les precautions d'emploi pour utiliser ce produit.
5. Ce produit ne doit pas être utilisé près d'eau, comme par exemple baignoires, éviers, piscine, sous-sol humides ... Etc.
6. Utiliser exclusivement un chiffon sec pour nettoyer ce produit.
7. Ne bloquer aucune ouverture de ventilation. Ne pas placer le produit tout contre un mur ou dans une enceinte fermée, cela génèrerait le flux d'air nécessaire au refroidissement.
8. Ne pas placer le produit près de toute source de chaleur telle que radiateurs, arrivées d'air chaud, fourneaux ou autres appareils générant de la chaleur (incluant les amplificateurs producteurs de chaleur) .
9. Ne pas négliger la sécurité que procure un branchement polarisé ou avec raccordement à la terre, Un branchement polarisé comprend deux fiches dont l'une est plus large que l'autre. Un branchement à la terre comprend deux fiches plus une troisième reliée à la terre. Si la fiche secteur fournie ne s'insert pas dans votre prise de courant. consulter un 'électricien afin de remplacer votre prise obsolète.
10. Protéger le cordon d'alimentation de tout écrasement ou pincement, particulièrement au niveau des fiches, des réceptacles utilisés et à l'endroit de sortie de l'appareil. Ne pas casser la fiche de terre du cordon d'alimentation.
11. Utiliser uniquement les accessoires spécifiés par le constructeur.
12. Utiliser uniquement avec le chariot de transport, le support, le trépied, la console ou la table spécifiés par le constructeur ou vendus avec l'appareil. Lors de l'utilisation d'un chariot, bouger avec précaution l'ensemble chariot/appareil afin d'éviter les dommages d'un renversement.
13. Débrancher cet appareil lors d'orages ou s'il n'est pas utilisé pendant une longue période.
14. Des precautions doivent être prises afin qu'aucun objet ne tombe et qu'aucun liquide ne se répande à l'intérieur de l'appareil par les orifices de ventilation ou n'importe quelle autre ouverture.
15. Pour toutes interventions techniques s'adresser à un technicien qualifié. L'intervention technique est nécessaire lorsque l'appareil a été endommagé de n'importe quelle façon, comme par exemple si le cordon secteur ou sa fiche sont détériorés, si du liquide a coulé ou si des objets sont tombés à l'intérieur de l'appareil, si l'appareil a été exposé à la pluie ou à l'humidité, s'il ne fonctionne pas normalement ou s'il est tombé.
16. ATTENTION: Pour réduire le risque d'incendie ou de choc électrique ne pas exposer l'appareil à la pluie ou à l'humidité.
17. Quand la prise MAINS, au coupler, est utilisé pour la source d'alimentation électrique, il est conseillé de garder cette prise facilement accessible.



# V15 Front Panel

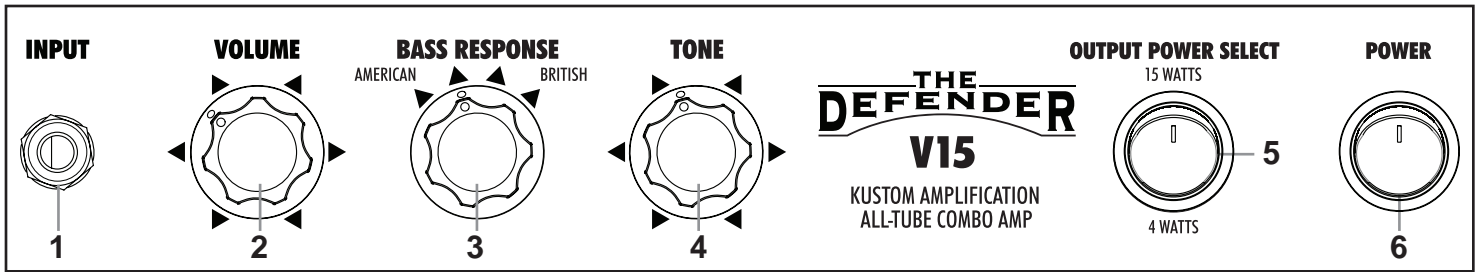

**1. INPUT JACK:** This is a ¼", 2-conductor input for plugging in your instrument. It is intended for guitar but will accept other instruments as well.

**2. VOLUME:** This control determines the overall volume level of the amplifier. Due to the simplicity of the Defender V15's all-tube circuitry, a wide range of tones can be obtained with the use of this control alone.

For example, when set in its lower ranges, the sound is clean and snappy. As the Volume control is turned up, light overdrive is generated by the amp's all-tube circuitry. This overdrive occurs naturally and is not created by any internal distortion circuit. As the Volume control is turned higher (clockwise), you'll hear increased natural drive and compression that is great for crunchy rhythms and sustaining guitar solos. In essence, the Defender V15 generates classic overdriven tube amp tone but at lower, more manageable volume levels. (Although you may be surprised by the amount of volume that the Defender V15 & 15H can generate, so watch your ears!)

**3. BASS RESPONSE:** This control varies the low frequency response and changes how the amp sounds and feels. When turned all the way to the left, the bass notes will have a looser, less focused sound reminiscent of vintage American tube amps. As you turn the knob clockwise, the bass notes gain a tighter, thicker attack with a distinctly British flavor.

**4. TONE:** The Tone control adjusts the balance of low, middle and high frequencies. When set at 12 o'clock, thicker control provides an even balance of all frequencies. When turned to the left, bass notes are emphasized providing a thicker tone. Turning the knob clockwise adds high frequencies to the tone. Higher settings will provide more bite and help you cut through the mix.

**5. OUTPUT POWER SELECT:** This control changes the output power of the amplifier. Set to 15 Watts for maximum volume and more headroom before the sound "breaks up" as a result of overdriving the tubes. Set to 4 Watts to achieve this distorted sound at lower volumes.

**6. POWER:** This dual-function component is both an ON/OFF power switch and a status indicator light. When illuminated, it shows that your amplifier is ready to be played. To turn your amplifier on, press switch upward. To turn amp off, press switch downward.

Note: After the power switch is turned on, the tubes must warm up for approximately one minute before you will hear sound from your amplifier.

# 15H Front Panel

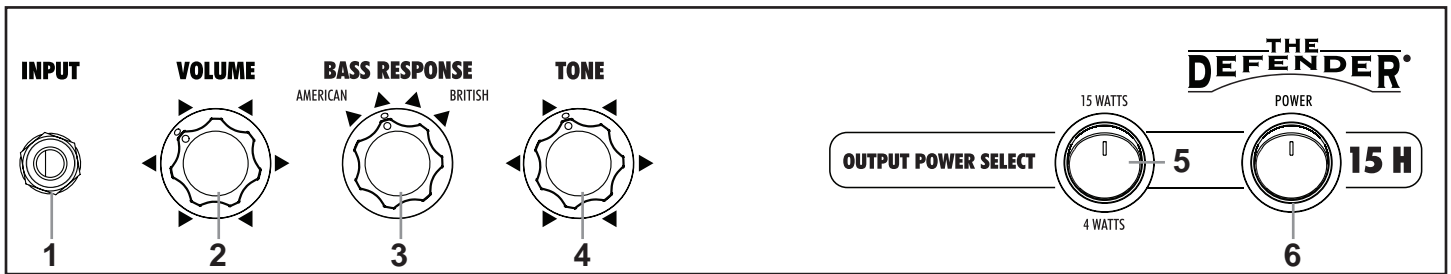

**1. INPUT JACK:** This is a 1/4", 2-conductor input for plugging in your instrument. It is intended for guitar but will accept other instruments as well.

**2. VOLUME:** This control determines the overall volume level of the amplifier. Due to the simplicity of the Defender 15H's all-tube circuitry, a wide range of tones can be obtained with the use of this control alone.

For example, when set in its lower ranges, the sound is clean and snappy. As the Volume control is turned up, light overdrive is generated by the amp's all-tube circuitry. This overdrive occurs naturally and is not created by any internal distortion circuit. As the Volume control is turned higher (clockwise), you'll hear increased natural drive and compression that is great for crunchy rhythms and sustaining guitar solos. In essence, the Defender 15H generates classic overdriven tube amp tone but at lower, more manageable volume levels. (Although you may be surprised by the amount of volume that the Defender V15 & 15H can generate, so watch your ears!)

**3. BASS RESPONSE:** This control varies the low frequency response and changes how the amp sounds and feels. When turned all the way to the left, the bass notes will have a looser, less focused sound reminiscent of vintage American tube amps. As you turn the knob clockwise, the bass notes gain a tighter, thicker attack with a distinctly British flavor.

**4. TONE:** The Tone control adjusts the balance of low, middle and high frequencies. When set at 12 o'clock, thicker control provides an even balance of all frequencies. When turned to the left, bass notes are emphasized providing a thicker tone. Turning the knob clockwise adds high frequencies to the tone. Higher settings will provide more bite and help you cut through the mix.

**5. OUTPUT POWER SELECT:** This control changes the output power of the amplifier. Set to 15 Watts for maximum volume and more headroom before the sound "breaks up" as a result of overdriving the tubes. Set to 4 Watts to achieve this distorted sound at lower volumes.

**6. POWER:** This dual-function component is both an ON/OFF power switch and a status indicator light. When illuminated, it shows that your amplifier is ready to be played. To turn your amplifier on, press switch upward. To turn amp off, press switch downward.

Note: After the power switch is turned on, the tubes must warm up for approximately one minute before you will hear sound from your amplifier.

## V15 & 15H Back Panel

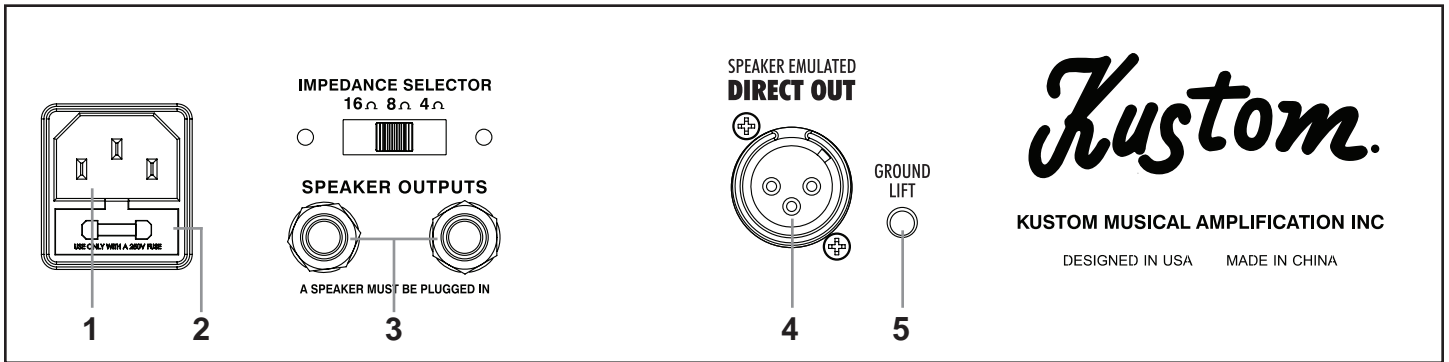

**1. AC POWER CORD RECEPTACLE:** Insert the AC cord (provided) firmly into the AC connector. NOTE: Replace the AC power cord if protective jacket is damaged or ground pin is damaged or removed. The fuse is located in a housing just below the receptacle. Replace only with same type and size. To remove the fuse, remove AC power cord and pull out on the tab above the fuse symbol located on the fuse carriage. Place the new fuse in the carriage clip and re-insert.

**NOTE:** To prevent an electrical hazard, **DO NOT** replace fuse without using the fuse carriage. Replace the fuse carriage if lost or damaged before re-inserting the AC power cord.

**2. FUSE:** The fuse is located in a fuse tray just below the receptacle. Replace only with the same type and size. For your convenience, a spare fuse is located inside the fuse tray toward the front. To replace fuse, remove AC power cord.

Remove fuse tray by pulling the tab located above the fuse symbol away from the receptacle.

**3. SPEAKER OUTPUTS:** These 1/4" jacks are provided to connect the internal and/or external speakers to the V15. **THE AMPLIFIER SHOULD NEVER BE OPERATED WITHOUT A SPEAKER PLUGGED INTO A SPEAKER JACK.**

**4. DIRECT OUT:** The XLR Direct Out jack is designed to connect the amplifier to a recording or live mixer. The output is speaker-emulated, and mimics the sound of the Celestion loudspeaker. This output is very useful for direct recording, and especially helpful for live applications since it eliminates a live microphone on stage and the resulting feedback potential.

**5. GROUND LIFT:** The Ground Lift switch disconnects pin 1 of the XLR Direct Out jack to eliminate a "ground loop" hum. A ground loop can exist when the amp and the mixer it is plugged into are connected to grounded outlets that are in physically different locations and/or on different circuits, and should only be used if there is an audible hum. Pressing the ground lift does not disconnect the ground connection from the chassis.

# V15 Signal Flow Diagram

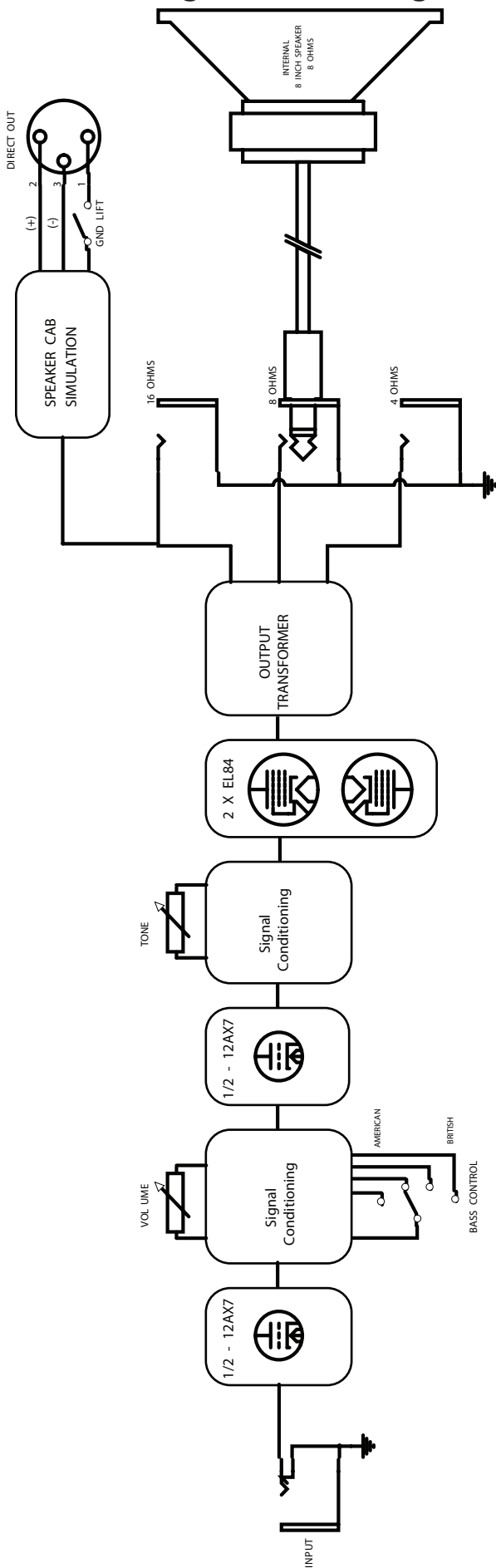

# 15H Signal Flow Diagram

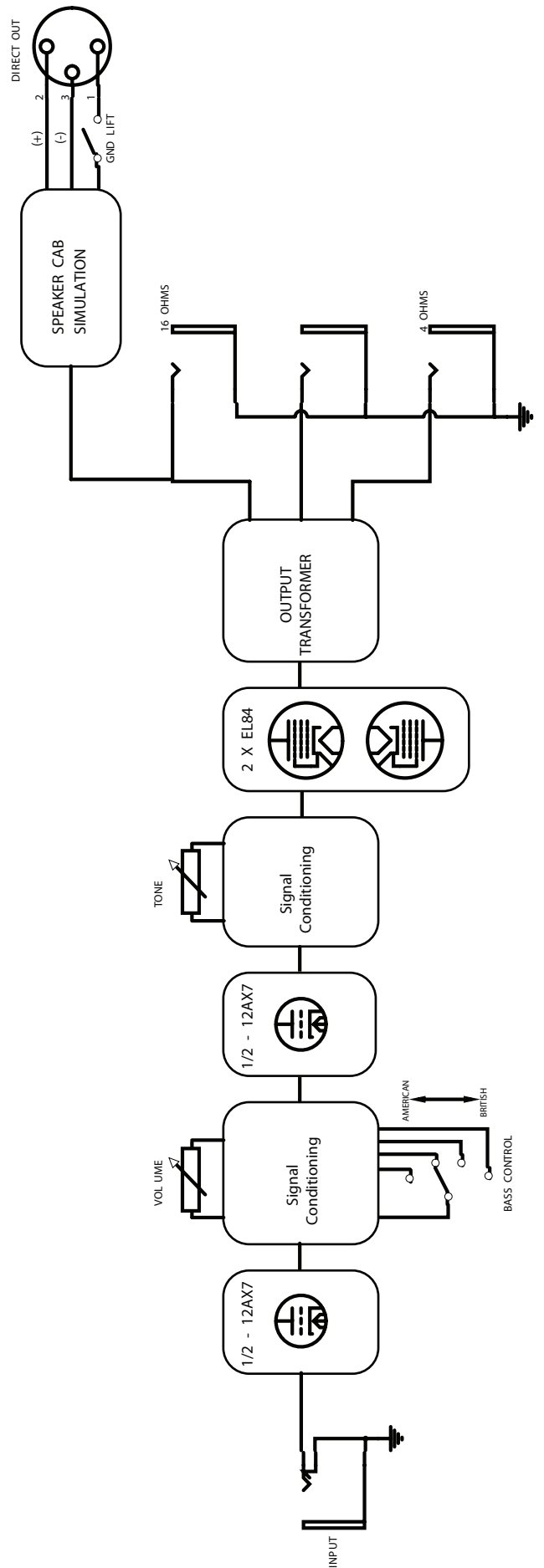



## V15 Specifications

<b>Output Power</b>	4 / 15 Watts	¼ inch jacks w/ impedance selector for 4 Ohm, 8 Ohm and 16 Ohm speakers Internal Speaker 8 Ohms
<b>Speaker</b>	1	10" Celestion
<b>Gain</b>	70dB	@ 1 kHz
<b>Preamp Tube</b>	1	12AX7
<b>Poweramp Tubes</b>	2	EL84
<b>Power Requirements</b>	USA / Canada	120VAC/60Hz 80W
	Europe	230VAC/50Hz 80W
	UK	230VAC/50Hz 80W
	Australia	240VAC/50Hz 80W
	Japan	100VAC/50-60Hz 80W
<b>Dimensions / Weight</b>	cm/Kilogram	40.2H x 41.8W x 21.5D 11.8 kg
	Inches/Pounds	15.8 H x 16.5 W 8.5 D 26 Lbs.

## 15H Specifications

<b>Output Power</b>	4 / 15 Watts	¼ inch jacks w/ impedance selector for 4 Ohm, 8 Ohm and 16 Ohm speakers Internal Speaker 8 Ohms
<b>Gain</b>	70dB	@ 1 kHz
<b>Preamp Tube</b>	1	12AX7
<b>Poweramp Tubes</b>	2	EL84
<b>Power Requirements</b>	USA / Canada	120VAC/60Hz 80W
	Europe	230VAC/50Hz 80W
	UK	230VAC/50Hz 80W
	Australia	240VAC/50Hz 80W
	Japan	100VAC/50-60Hz 80W
<b>Dimensions / Weight</b>	cm/Kilogram	14 H x 36.7 W x 22.5 D 4.8 kg
	Inches/Pounds	5.5 H x 14.4 W x 8.9 D 10.58 Lbs.

# EC Declaration of Conformity

We: Kustom Musical Amplification INC.  
3015 Kustom Drive  
Hebron, Ky 41048-0568  
Tel: 1-859-817-7100 Fax: 1-859-817-7150

Declare that the product

Product name: **Kustom**

Product model number: **DEFENDER V15 & DEFENDER 15H**

to which this declaration relates is in conformity with the following standards;

EN55013: 2001/+A1:  
2003+A2: 2006 Limits and methods of measurement of radio disturbance characteristics of broadcast receivers and associated equipment.

EN55020: 2007 Electromagnetic immunity of broadcast receivers and associated equipment.

EN61000-3-2: 2006 Limits for harmonic current emissions (equipment input current < 16A per phase).

EN61000-3-3: 2008 Limitation of voltage fluctuations and flicker in low voltage supply systems for equipment with rated currents < 16A.

EN60065: 2002+A1:  
2006+A11: 2008 Safety requirements for main operated electronic and related apparatus for household and similar general use.

Following the provisions of EU Council Directive(s): 72/73 EEC and 89/336/EEC.

We the undersigned, hereby declare that the equipment specified above conforms to the aforementioned directive(s).

Name of authorized person: James Brown, Chief Engineer

Signature: 

Date: **March 15, 2011**

Kustom Musical Amplification INC.  
3015 Kustom Drive  
Hebron, Ky 41048-0568  
Tel: 1-859-817-7100 Fax: 1-859-817-7150



[www.kustom.com](http://www.kustom.com)

Kustom Amplification, Inc.

3015 Kustom Drive

Hebron, Kentucky

USA 41048

888-4-KUSTOM (888-458-7866)

All specifications are subject to change without prior notice. ©2011 Kustom

