

# **KitchenAid®**

*Electric 30" Built-In  
Single and Double  
Self-Cleaning Ovens*

**MODELS KEBI100V and KEBI200V**



**USE and CARE GUIDE**

# Table of Contents

	Page
Important Safety Instructions . . . . .	3 - 4
Ownership Registration . . . . .	5
Built-In Oven Features . . . . .	6 - 7
Using the Oven . . . . .	8 - 12
Electronic Clock Operation . . . . .	8
Oven Controls . . . . .	9
Preheating the Oven . . . . .	9
Baking or Roasting in the Oven . . . . .	10
Baking or Roasting with Time Bake . . . . .	10 - 12
Broiling in the Oven . . . . .	12
Care and Cleaning . . . . .	13 - 18
Control Knobs . . . . .	13
Glass Surfaces . . . . .	13
Porcelain Surfaces . . . . .	13
Chrome Surfaces and Trim . . . . .	13
Broiler Pan . . . . .	13
Oven Racks . . . . .	13
Lower Oven Interior . . . . .	13
Self-Clean Oven Cycle . . . . .	13 - 16
The Oven Light . . . . .	16 - 17
Removing an Oven Door . . . . .	17
Optional Glass Oven Door Front . . . . .	17
Adjusting the Oven Temperature Control . . . . .	18
For Service or Assistance . . . . .	19
KitchenAid Warranty . . . . .	Back Cover

© 1989 KitchenAid, Inc.

## **⚠ WARNING**

**Read all instructions before using the oven. To reduce the risk of fire, electrical shock, injury to persons, or damage when using the oven, follow basic precautions, including the following.**

1. Install or locate this oven only in accordance with the provided Installation Instructions.
2. Do not use the oven for warming or heating the room. Persons could be burned or injured, or a fire could start.
3. Do not leave children alone in area where oven is in use. They should never be allowed to sit or stand on any part of the oven. They could be burned or injured.
4. Do not wear loose or hanging garments when using the oven. They could ignite if they touch a heating element and you could be burned.
5. Do not repair or replace any part of the oven unless specifically recommended in this manual. All other servicing should be referred to a qualified technician.
6. Do not store flammable materials in or near the oven. They could explode or burn.
7. Do not use water on grease fires. Never pick up a flaming pan. Smother flaming pan by covering with a well-fitted lid, cookie sheet or flat tray. Flaming grease outside pan can be extinguished with baking soda, or if available, a multipurpose dry chemical or foam-type extinguisher.
8. Use only dry potholders. Moist or damp potholders on hot surfaces may result in burns from steam. Do not let potholder touch hot heating elements. Do not use a towel or bulky cloth for a potholder. They could catch on fire.
9. Use care when opening oven door. Let hot air or steam escape before removing or replacing food.
10. Do not heat unopened containers. They could explode. The hot contents could cause burns and container particles could cause injury.
11. Keep oven vents unobstructed.
12. Always position oven racks in desired location while oven is cool. If rack must be moved while oven is hot, do not let potholder contact hot heating element in oven.
13. Do not clean door gasket. It is essential for a good seal. Care should be taken not to rub, damage, or move the gasket. Clean only parts recommended in this manual.
14. Do not use oven cleaners. No commercial oven cleaner or oven liner protective coating of any kind should be used in or around any part of the oven.

continued on next page

15. Before self-cleaning the oven, remove broiler pan, broiler grid, oven racks and other utensils. Do not use your oven to clean miscellaneous parts.
16. Do not store things children might want above the oven. Children could be burned or injured while climbing on it.
17. Do not touch heating elements or interior surfaces of oven. Heating elements may be hot even though they are dark in color. Interior surfaces of an oven become hot enough to cause burns. During and after use, do not touch, or let clothing or other flammable materials contact heating elements or interior surfaces of oven until they have had sufficient time to cool. Other surfaces of the oven may become hot enough to cause burns; such as, the oven vent opening, the surface near the vent opening, the oven door, and the oven door window.

### **FOR YOUR SAFETY**

**DO NOT STORE OR USE GASOLINE OR OTHER FLAMMABLE  
VAPORS AND LIQUIDS IN THE VICINITY OF THIS OR  
ANY OTHER APPLIANCE. THE FUMES CAN CREATE A  
FIRE HAZARD OR EXPLOSION.**

**SAVE THESE INSTRUCTIONS**

# Ownership Registration

Please fill out and mail your Ownership Registration Card packed with the Use and Care Guide. This card will enable us to contact you in the unlikely event of a product safety notification and assist us in complying with the provisions of the Consumer Product Safety Act. Return of this card is not necessary to validate your warranty.

You must provide proof of purchase or installation date for in-warranty service.

Write down the following information. You will need it if your oven ever requires service.

**Model Number\*** \_\_\_\_\_

**Serial Number\*** \_\_\_\_\_

**Date Purchased** \_\_\_\_\_

**Date Installed** \_\_\_\_\_

**Builder's or Dealer's Name** \_\_\_\_\_

**Address** \_\_\_\_\_

**Phone** \_\_\_\_\_

\*Model and serial numbers are located on the upper left side of the door opening on the Single/Upper Oven.

# Built-In Oven Features

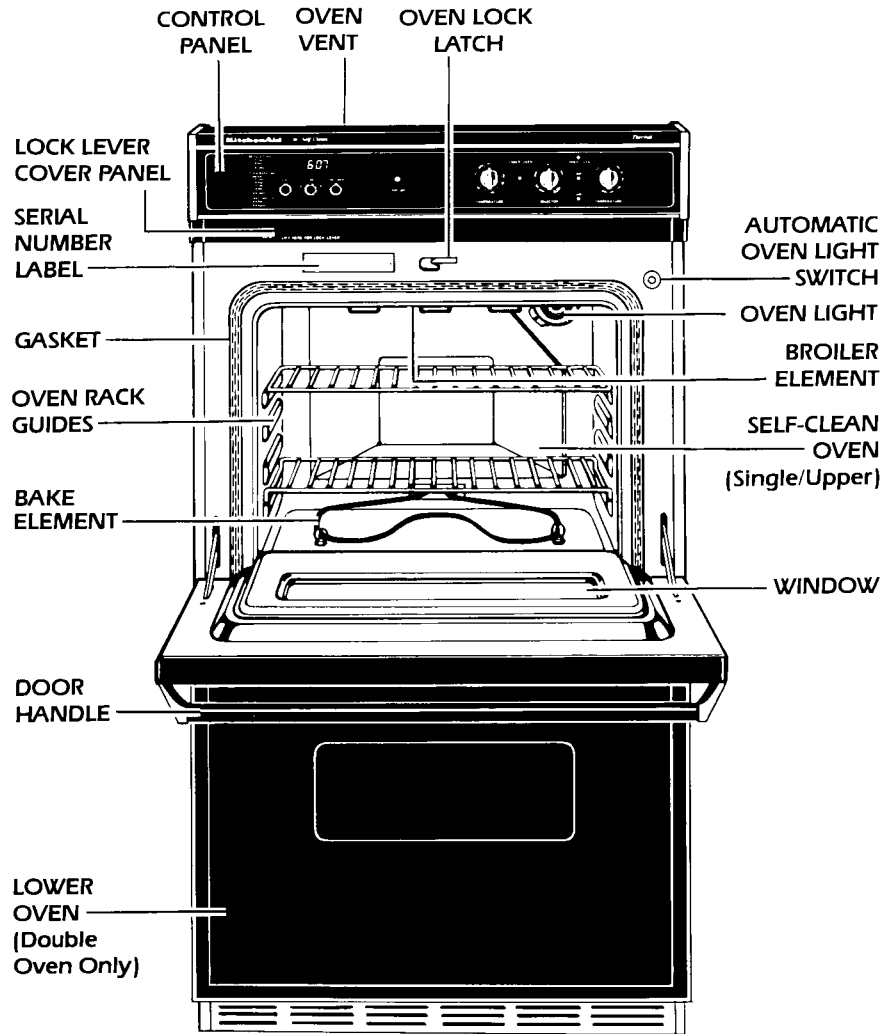

## DOUBLE OVEN CONTROL PANEL

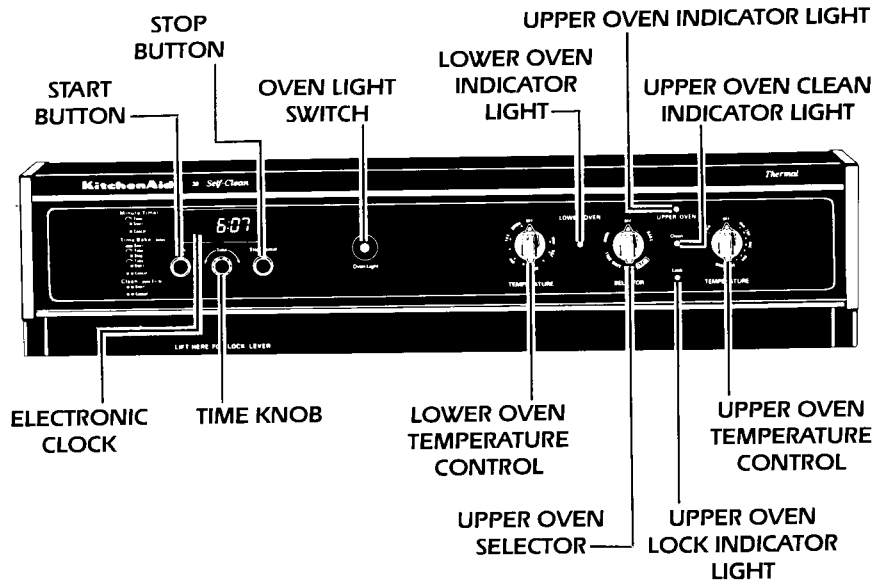

## SINGLE OVEN CONTROL PANEL

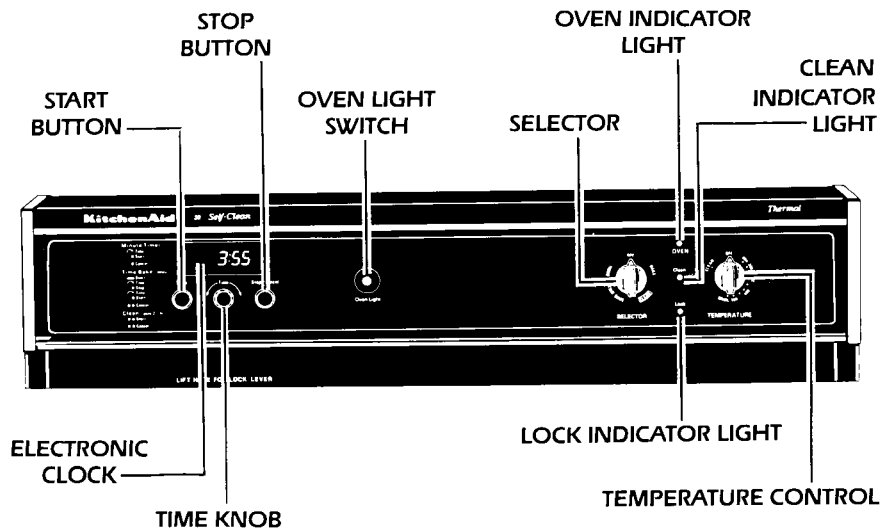

# Using the Oven

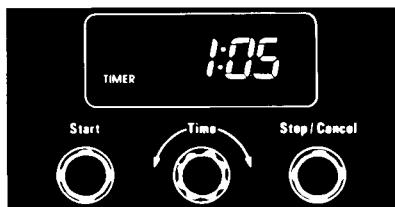

## Electronic Clock Operation

The electronic clock controls all timed operations for the Single/Upper Oven. It consists of the Display Window, START button, TIME knob and STOP/CANCEL button. When your oven is first connected to the power in your home, "00:00" will appear in the Display Window.

### TO SET THE TIME OF DAY:

1. Turn the TIME knob to the left until a tone is heard and "TIME" appears in the Display Window. The previously set time (or "12:00") will appear in the Display Window.
2. Continue turning the TIME knob in either direction until the correct time of day appears in the Display Window.
3. Press the START button to begin clock operation.

### TO USE THE MINUTE TIMER:

The Minute Timer can be programmed from 5 seconds to 99 minutes for precise timing of short and long-term cooking, or any other activity. The Minute Timer is only an audible reminder and will not turn the oven ON or OFF.

1. To use, turn the TIME knob to the right. The Display Window will immediately change to ":05" and "TIMER" will be displayed.
2. Continue turning the TIME knob until the desired time is displayed (in minutes and seconds) in the Display Window.
3. To start the Minute Timer, press the START button.

The Display Window will continue to show "TIMER" and the selected time will begin counting down. At the end of the timed period, "TIMER" will appear in the Display Window and flash rapidly and a tone will sound for 3 seconds, after which an intermittent tone will sound until the Minute Timer is cancelled, or until a total of 15 minutes have elapsed.

**IMPORTANT:** The current time of day may be checked while the Minute Timer is in use by touching the START button. The time of day will be displayed for 7 seconds, then return to the Minute Timer program in progress.

To cancel a Minute Timer program in progress, press the STOP/CANCEL button once. A tone will sound and the clock will return to the time of day.

When turning the TIME knob to set the Minute Timer, the time will appear in the Display Window and increase in the following increments:

From 5 seconds to 2 minutes	5 second increments
From 2 minutes to 10 minutes	10 second increments
From 10 minutes to 20 minutes	30 second increments
From 20 minutes to 99 minutes	1 minute increments

**IMPORTANT:** The Minute Timer may be used at the same time as an Automatic Time Cooking or Self-Clean program. The Time Cooking or Self-Clean program must be set first, then the Minute Timer. One touch of the STOP/CANCEL button will cancel the Minute Timer and two touches will cancel the cooking or cleaning program.



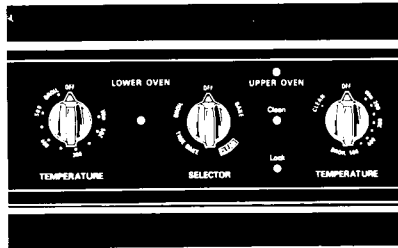

## Oven Controls

The ovens (Single/Upper and Lower) can be used for baking, roasting and broiling. The Single/Upper Oven has two controls – a Selector and a Temperature Control. Both must be set for the oven to work. The Lower Oven has one control – a Temperature Control.

### THE SINGLE/UPPER SELECTOR HAS FIVE SETTINGS:

**BAKE** – Use this setting for baking and roasting. Both the upper and lower elements will come on.

**CLEAN** – Use this setting for self-cleaning only.

**TIME BAKE** – Use this setting for Automatic Time Baking. Both the upper and lower elements come on.

**BROIL** – Use this setting for broiling. Only the upper element will come on.

**OFF** – Use this setting to turn the oven off.

### TEMPERATURE CONTROLS

The ovens have an adjustable Temperature Control (see page 18). They can be set at any temperature from WARM (150°F) to BROIL (550°F). The Single/Upper Oven Temperature Control also has a CLEAN setting. Settings WARM to 225°F are suggested for warming and holding foods.

## Preheating the Oven

For best results, preheat the oven until the Oven Indicator Light goes out, unless the recipe states otherwise. Set the Selector to BAKE and the Temperature Control to the desired temperature. Exercise care in turning the Temperature Control so you do not go past the desired set point. If you accidentally go past the desired setting, return the dial to OFF and reset to the desired setting. The Oven Indicator Light will go out when the desired temperature has been reached and will cycle on and off with the elements during the heating period.

When both the upper and lower elements are on, the upper element operates at partial power to aid in more uniform baking. The upper element does not turn red like the lower element which operates at full power.

Be sure the Selector and Temperature Control are turned to OFF when the oven is not in use.

## Baking or Roasting in the Oven

### SINGLE/UPPER OVEN

1. Arrange the oven racks in the desired positions.
2. Set the Temperature Control to the recommended temperature. See the Baking or Roasting Chart in the Cooking Guide.
3. Turn the Selector to BAKE.
4. Place the food in the oven after the Oven Indicator Light goes out, or when the recipe specifies.

Be sure to turn the Selector and the Temperature Control to OFF when cooking has been completed.

### LOWER OVEN (For Double Ovens)

1. Arrange the oven racks in the desired positions.
2. Set the Temperature Control to the recommended temperature. See the Baking or Roasting Chart in the Cooking Guide.
3. Place the food in the oven after the Oven Indicator Light goes out, or when the recipe specifies.

Be sure to turn the Temperature Control to OFF when cooking has been completed. The oven will remain ON if left at any other setting.

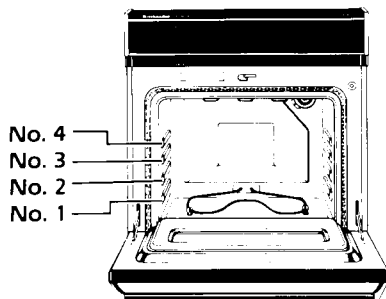

### RACK POSITIONS

There are two racks for each oven. One rack is straight and the other is offset.

Your KitchenAid oven has four rack positions. Rack position 4 is the highest position, or farthest from the bottom

of the oven. Rack position 1 is the lowest position, closest to the bottom of the oven. Be sure to arrange the oven rack(s) before putting foods into the oven or turning the oven on.

### TO REMOVE OVEN RACKS:

1. Straight rack – Lift rack and pull forward.
2. Offset rack – Pull rack out until bar on back of rack touches stop. Lift front of rack up until rear position of rack slides out.

**Never cover self-cleaning oven bottom or an entire oven rack with foil. Foil can obstruct normal heat flow, cause cooking failures and damage the oven interior.**

### Baking or Roasting with Time Bake

Using the TIME BAKE setting allows you to turn the Single/Upper Oven on and off automatically. The starting time can be set for now or later in the day. On double oven models, only the upper oven can be set to Automatic Time Bake.

1. Arrange oven racks in desired positions and place food in the oven.

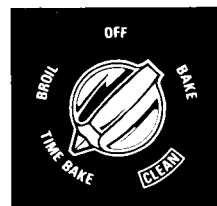

2. Turn the Selector to TIME BAKE and set the Temperature Control to the desired temperature.
3. Check to see that the electronic clock is set to the correct time of day. If not, reset to the correct time following the instructions on page 8.

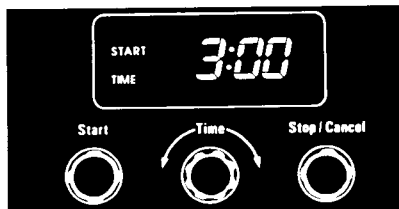

4. Set the start time. Touch the START button and hold down for 3 seconds. "START TIME" will appear in the Display Window and a short tone will sound.
5. To start now, touch the START button again to lock in the start time and go to the next step.

To start later, turn the TIME knob until the desired start time appears in the Display Window, then touch the START button again to lock in the start time.

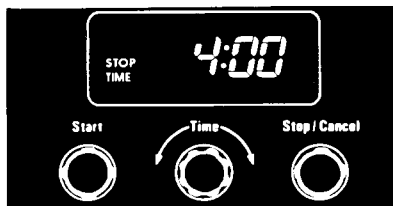

6. Set the stop time. After the start time is set, "STOP TIME" will appear in the Display Window and a short tone will sound. Turn the TIME button until the desired stop time appears in the Display Window. Touch the START button again to lock in the stop time and begin the program.



7. "AUTO" will appear continuously in the Display Window if the Automatic Time Bake cycle has been programmed to start now. "AUTO" will flash in the Display Window if the Automatic Time Bake cycle has been programmed to start later. "AUTO" will change from flashing to continuous when the programmed start time is reached.

**To avoid sickness and food waste when using Time Bake:**

- Do not use foods that will spoil while waiting for cooking to start, such as dishes with milk or eggs, cream soups, and cooked meats or fish. Any food that has to wait for cooking to start should be very cold or frozen before it is put in the oven. **MOST UNFROZEN FOODS SHOULD NEVER STAND MORE THAN TWO HOURS BEFORE COOKING STARTS.**
- Do not use foods containing baking powder or yeast when using delay start. They will not rise properly.
- Do not allow food to remain in oven for more than two hours after end of cooking cycle.

### **WHAT HAPPENS DURING TIME BAKE SELECTION?**

- The oven will come on at the time selected and maintain the temperature set on the Temperature Control until the selected stop time.
- At the end of the cooking period, the oven will shut off. A tone will sound for three seconds, followed by an intermittent tone until the STOP/CANCEL button is touched or a total of 15 minutes has elapsed. Food should be removed from the oven when the cooking time has ended, or they may overcook.

### **TO REVIEW A PROGRAM:**

Press and hold the START button for the start time or the STOP/CANCEL button for the stop time for three seconds. The start or stop time will appear in the Display Window for seven seconds.

If you wish to change the start or stop time after a cooking program has been entered, press and hold the START button for the start time or STOP/CANCEL button for the stop time for three seconds. Turn the TIME knob to the new desired time, then touch the START button to lock in the new time.

### **TO CANCEL AUTOMATIC TIME BAKE:**

If you wish to cancel Automatic Time Bake while in progress, touch the STOP/CANCEL button twice. A tone will sound each time and the clock will return to the present time of day. The oven will automatically turn itself off. If you wish to continue cooking in the oven, the Selector and Temperature Control must be manually reset.

### **Broiling in the Oven**

Broiling is a quick-cook method that will produce foods that are brown on the outside and moist and juicy on the inside.

#### **SINGLE/UPPER OVEN**

1. Arrange the oven racks in the desired positions. See the Broiling Chart in the Cooking Guide.
2. Place food on grid on broiler pan and place in center of the oven rack.
3. Set the Temperature Control to BROIL.
4. Turn the Selector to BROIL. Do not preheat the broiler.
5. Position the oven door at the broil stop position.

#### **LOWER OVEN (For Double Ovens)**

1. Arrange the oven racks in the desired positions. See the Broiling Chart in the Cooking Guide.
2. Place food on grid on broiler pan and place in center of the oven rack.
3. Set the Temperature Control to BROIL (550°F).
4. Position the oven door at the broil stop position.

**IMPORTANT:** If preferred, the oven door can be closed during broiling, but food may not be as well browned.

#### **Fire Hazard**

**Fire hazard may result when broiler grid is fully covered with foil. Accumulated grease can cause a fire. Proper use of foil with broiler grid is to cut slits in foil to correspond with all openings in broiler grid. Grease can then drain away and cool in pan.**

# Care and Cleaning

Several finishes have been used on this oven. To prevent damage to these finishes, follow the suggested cleaning method(s) for that finish.

**IMPORTANT:** Some finishes can be damaged from harsh and abrasive cleaning agents.

**To avoid burns and possible electric shock, first make sure all controls are OFF and the oven is COOL.**

## Control Knobs

Pull the control knobs straight off. Wash with detergent and hot water, then rinse well. Dry completely and replace by pushing them firmly into place.

**IMPORTANT:** Make sure all the control knobs point to the OFF position.

## Glass Surfaces

Clean surface with detergent and hot water. Rinse and dry well. Use mild glass cleaner to remove fingermarks.

## Porcelain Surfaces

Clean surface with detergent and hot water. Rinse and dry with soft cloth.

## Chrome Surfaces and Trim

Clean with soap and hot water. Rinse and dry well. Use mild glass cleaner to remove fingermarks. For stubborn spots, clean with ammonia solution of 1 cup ammonia to 2 gallons of water.

## Broiler Pan

Clean with detergent and hot water. For stubborn spots, use a soap-filled steel wool pad with plenty of water. Rinse well.

## Oven Racks

Clean with detergent and hot water. For stubborn spots, soak in ammonia solution of 1 cup ammonia to 2 gallons of water.

## Lower Oven Interior (Double Oven)

Clean with detergent and hot water. Rinse well with clear water and dry with

a soft towel. To remove heavy soil use commercial oven cleaner or scouring pad.

## Self-Clean Oven Cycle (Single/Upper Oven)

The Self-Clean cycle is designed to eliminate the need for scrubbing and scouring soil baked onto the oven interior. Food spatters on the oven wall become harder to remove each time the oven is heated, but because the Self-Clean cycle heats these soils to a higher temperature (850°F – 900°F), the soil is burned off.

Your KitchenAid oven offers a variable time Self-Clean cycle to give you excellent flexibility when self-cleaning your oven. The length of cleaning time can be set to meet your cleaning needs. A 2½ to 3 hour Self-Clean cycle is usually ample to clean a moderately soiled oven. A 4 hour Self-Clean cycle is suggested for an oven with heavy soil build-up. The Self-Clean cycle can also be delayed to a more convenient time if desired.

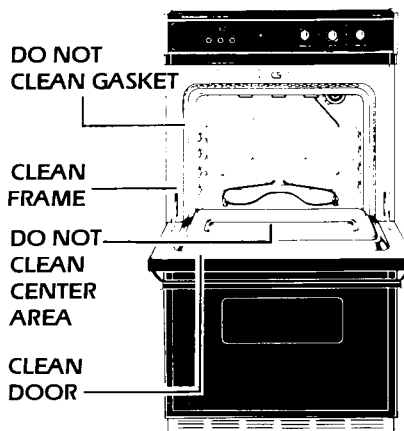

## BEFORE STARTING A SELF-CLEAN CYCLE

1. Turn oven light off before using the Self-Clean cycle to extend the oven light bulb life. If you do not turn oven light off at this time, oven light will turn off automatically once Self-Clean cycle is selected.

continued on next page

- Remove all items and the oven racks from the oven. It is recommended that the oven racks be removed as they will discolor and darken during the Self-Clean cycle. If the oven racks remain in the oven during the Self-Clean cycle, wipe the sides with vegetable oil after cleaning so they will slide more easily. Broiler pan, broiler grid or cooking utensils should not be cleaned in the oven. Heavy grease build-up on these items will produce smoke which can be discharged into the kitchen.
- Wipe up large spillovers in the oven cavity with a damp cloth. Never use chemical oven cleaners inside a self-cleaning oven or on raised portion of the door.

The smoke eliminator will handle the normal flow of odors during the Self-Clean cycle. However, minor smoke may be noticed when soil build-up is heavy.

- Wipe soil from oven frame area outside of gasket, and inside the oven door using detergent and hot water. (The center area of the door does not need to be hand cleaned.) Rinse well with mixture of vinegar and water and wipe dry. A non-scratch scouring pad may be used on heavily soiled areas. Wash surfaces frequently to minimize overall cleaning as these areas are not cleaned during the Self-Clean cycle.

**Do not clean gasket. Do not move it or bend it. Poor cleaning and poor baking results may occur.**

**IMPORTANT:** The lower oven will not operate while the upper oven is being cleaned.

### STARTING THE AUTOMATIC SELF-CLEAN CYCLE

- Follow steps under "BEFORE STARTING A SELF-CLEAN CYCLE."
- Check to see that the electronic clock is set to the correct time of day. If not, reset to the correct time following the instructions on page 8.



- Set the Selector to CLEAN.
- Lift the panel between the oven door and the control panel. Slide the Oven Lock Lever all the way to the right. You will hear a loud click and "START TIME" will appear in the Display Window.

**IMPORTANT:** Do not bake with the Oven Lock Lever in the locked position.

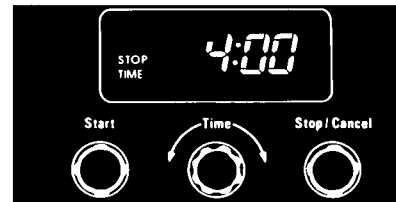

- Touch the START button to lock in the time of day as the start time. "STOP TIME" and the actual cleaning time, 2½ hours from the preset time of day, will appear in the Display Window.

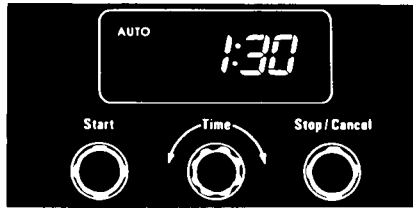

6. Touch the START button to lock in the automatically selected stop time and return the clock to the preset time of day. "AUTO" will appear in the Display Window and the cleaning cycle will begin. No end of cycle tone will be given.
7. The Clean Indicator Light and "AUTO" will go out.

#### **DELAYING THE AUTOMATIC SELF-CLEAN CYCLE**

The start of the Self-Clean cycle can be postponed to a more convenient time, if desired. The controls may be set to delay the Self-Clean cycle for up to twelve hours.

1. Follow steps 1, 2, 3 and 4 under "STARTING THE AUTOMATIC SELF-CLEAN CYCLE."
2. Turn the TIME knob until the desired new start time appears in the Display Window.
3. Touch the START button to lock in the new start time. "STOP TIME" and the actual cleaning stop time, 2½ hours from the selected start time, will appear in the Display Window.
4. Touch the START button to lock in the stop time and return the clock to the present time of day. "AUTO" will flash in the Display Window until the Self-Clean cycle begins. Once the cycle is in progress, "AUTO" will appear continuously. No end of cycle tone will be given.

#### **EXTENDING THE AUTOMATIC SELF-CLEAN CYCLE**

If your oven is excessively dirty and requires longer cleaning time, the Automatic Self-Clean cycle can be extended for up to 4 hours.

1. Follow steps 1, 2, 3 and 4 under "STARTING THE AUTOMATIC SELF-CLEAN CYCLE."
2. When "STOP TIME" appears in the Display Window, turn the TIME knob to the right until the desired length of cleaning time is displayed. Remember, you will be adding time to the normal 2½ hour cleaning time.  
**IMPORTANT:** A self-cleaning time longer than 4 hours cannot be selected.
3. Touch the START button to lock in the new stop time and return the clock to the present time of day.
4. "AUTO" will appear in the Display Window and the Self-Clean cycle will begin. No end of cycle tone will be given.

#### **COMBINING THE DELAY AND EXTENDED SELF-CLEAN CYCLE OPTIONS**

An Automatic Self-Clean cycle can be both delayed and extended if desired.

1. Follow steps 1, 2, 3 and 4 under "STARTING THE AUTOMATIC SELF-CLEAN CYCLE."
2. Set the delayed start time by turning the TIME knob until the new start time appears in the Display Window.
3. Touch the START button to lock in the new start time. "STOP TIME" and the actual cleaning stop time, 2½ hours from the selected start time, will appear in the Display Window. Turn the TIME knob until the new cleaning stop time appears in the Display Window.
4. Touch the START button again to lock in the new stop time and return the clock to the preset time of day.
5. "AUTO" will flash in the Display Window until the Self-Clean cycle begins. Once the cycle is in progress, "AUTO" will appear continuously. No end of cycle tone will be given.

### WHAT HAPPENS DURING THE SELF-CLEAN CYCLE?

After the controls have been set on a non-delayed cycle, or after the delayed time has elapsed on a delayed cycle:

- The Oven Indicator Light will glow to tell you the oven is heating.
- The Clean and Oven Indicator Lights will glow to tell you the oven is heating to the clean temperature, and "AUTO" will appear continuously in the Display Window.
- The Lock Indicator Light will come on when the temperature reaches 575°F – 600°F (approximately 15 minutes).

At the end of the Self-Clean cycle:

- The Oven and Clean Indicator Lights will go out.
- The Lock Indicator Light will continue to glow until the oven temperature drops below 550°F. The oven door cannot be opened until the Lock Indicator Light goes out.

### TO STOP THE SELF-CLEAN CYCLE AT ANY TIME:

1. Touch the STOP/CANCEL button twice. A tone will sound each time and the clock will return to the present time of day.
2. Slide Oven Lock Lever all the way to the left.

**IMPORTANT:** If the Lock Indicator Light has come on, wait until oven cools and light goes off before sliding Lock Lever back to the left.

**Do not force it. Wait until it moves easily.**

3. Turn Selector to OFF.

### TO RETURN OVEN TO REGULAR USE AFTER A SELF-CLEAN CYCLE:

1. Slide the Oven Lock Lever all the way to the left.
2. Turn the Selector to OFF.
3. Allow oven to cool sufficiently before wiping up any residue.

### OVEN SELF-CLEANING TIPS

- Evening is a good time to clean oven, after normal oven use is completed.
- Small amounts of smoke escaping from the oven vent are normal when oven is heavily soiled. Excessive smoke may indicate heavy spillovers have not been wiped up.
- **Do not** force the Oven Lock Lever open when the Lock Indicator Light is on. Damage to the lock mechanism may result.
- Clean the Single/Upper Oven regularly, before it becomes "excessively dirty." If oven is not clean after one cycle, repeat the Self-Clean cycle.
- After a Self-Clean cycle, any powdery residue can be wiped away with a damp cloth. If white spots remain in the oven after a Self-Clean cycle, remove them with a non-scratch scouring pad before using the oven again. These spots are usually salt residues that cannot be removed during the Self-Clean cycle.
- If the soil removal was not complete, increase the length of the clean time in the next cycle.

### The Oven Light

Oven light(s) automatically come on in the oven(s) when an oven door is opened. The light(s) can be turned on when the doors are closed by pushing the Oven Light Switch on the control panel.

### REPLACING A LIGHT BULB

**Electrical Shock Hazard**  
Make sure oven is cool and power to the oven has been turned off before replacing the light bulb. Failure to do so could result in electrical shock. Never touch an oven light bulb with a damp cloth unless the power is turned off to the oven and the bulb is cool to the touch.



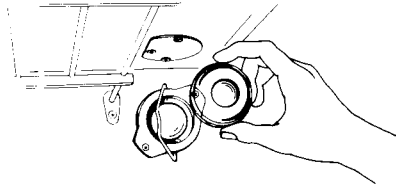

1. Remove the bulb cover in the back of the oven by pulling out and pushing the wire holder to the side.
2. Remove and replace the light bulb with a 40-watt appliance bulb.
3. Replace the bulb cover and snap the wire holder in place.
4. Turn the power back on at the main power supply.

### Removing an Oven Door

The lower oven door can be removed to make cleaning the lower oven easier. The Single/Upper self-cleaning oven door should **not** be removed for cleaning. Both doors can be removed to change optional oven door fronts.

**IMPORTANT:** Use caution as oven doors are heavy. The upper door on Double Ovens is much heavier than the lower door.

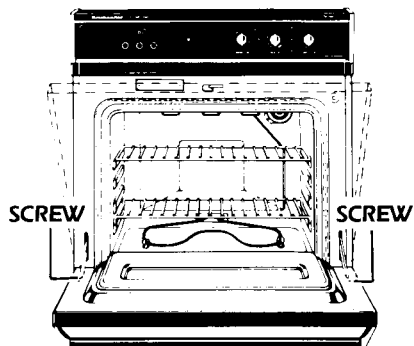

1. Open door completely.
2. Remove the screw above the hinge on one side of the door with a phillips-head screwdriver.

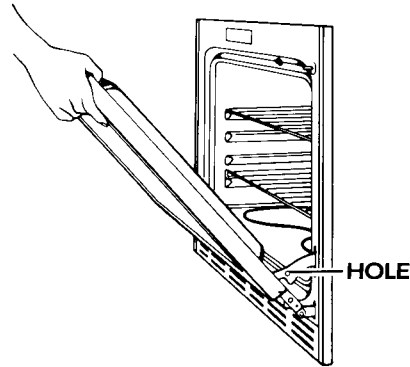

3. To prevent the door from closing quickly and damaging the porcelain finish, place a thin metal object (such as a small screwdriver) in the hole in the hinge.
4. Repeat steps 2 and 3 on the opposite side of the door.
5. Close door to the broil stop position (door will be open about 6 inches).
6. Hold the door firmly on both sides and lift the door off the hinge arm assemblies. Do not lift by the handle.
7. Replace the oven door by using the opposite procedure.

**IMPORTANT:** The inside of Single/Upper Oven door has a slot for the Oven Lock Lever. Do not replace Lower Oven door on Upper Oven cavity, or damage to the interior finish may result from the Oven Lock Lever hitting the door surface.

### Optional Glass Oven Door Front

The front door glass can be changed to white or almond colored glass by ordering one of these kits. White (Kit No. 814069) or Almond (Kit No. 814070) from your KitchenAid dealer. These kits include easy installation instructions.

## Adjusting the Oven Temperature Control

Both ovens have been properly adjusted at the factory to provide accurate temperatures.

If after using the oven(s) for a period of time, you are not satisfied with the temperature settings, they can be adjusted by following these steps:

1. Pull the Temperature Control knob straight off.

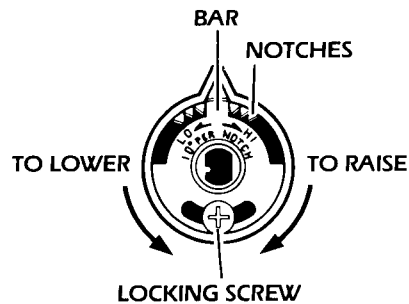

2. Loosen the screw  $\frac{1}{2}$  turn with a Phillips-head screwdriver. Note the position of the notches.
3. To lower the temperature, move the bar a notch closer to LO. Each notch equals about 10°F (5°C).
4. To raise the temperature, move the bar a notch closer to HI. Each notch equals about 10°F (5°C).
5. Tighten the screw and replace the knob.

# For Service or Assistance

## Follow These Steps

1. If your oven should fail to operate, review the following list before calling your dealer. You could save the cost of a service call.
  - Have instructions in this book been followed?
  - Has the fuse blown, or is the circuit breaker open?
  - Is the Selector set in the correct position?
  - Is Oven Lock Lever in proper position for cooking (left) or cleaning (right)?
  - Recheck suspected defect.
2. If the problem is not due to one of the above items, first call your dealer or repair service he recommends.
  - All service should be handled locally by the dealer from whom you purchased the oven or an authorized KitchenAid servicer.
3. In the event you are unable to obtain the name of a local authorized KitchenAid servicer, call KitchenAid Customer Relations, TOLL FREE: **800-422-1230**.
  - A Customer Relations representative can recommend a qualified service company in your area.

If you must call or write, please provide: Model Number, Serial Number, Date of Purchase and complete description of the problem.  
Write to:

Customer Relations Department  
KitchenAid, Inc.  
P.O. Box 558  
St. Joseph, MI 49085-0558

Please include a daytime phone number in your correspondence.
4. If you are not satisfied with the action taken, contact the Major Appliance Consumer Action Panel (MACAP). MACAP is a group of independent consumer experts that voices consumer views at the highest levels of the major appliance industry. Contact them only when the dealer, authorized servicer or KitchenAid Inc., have failed to resolve your problem.

Major Appliance Consumer  
Action Panel  
20 North Wacker Drive  
Chicago, IL 60606

MACAP will in turn inform us of your action.

# KitchenAid

## Electric Built-in Oven Warranty

LENGTH OF WARRANTY:	KITCHENAID WILL PAY FOR:	KITCHENAID WILL NOT PAY FOR:
<b>ONE YEAR FULL WARRANTY</b> FROM DATE OF INSTALLATION.	Replacement parts and repair labor to correct defects in materials or workmanship. Service must be provided by an authorized KitchenAid servicing outlet.	A. Service calls to: 1. Correct the installation of the oven. 2. Instruct you how to use the oven. 3. Replace house fuses or correct house wiring.
<b>FIVE YEAR LIMITED WARRANTY</b> ONE YEAR FULL PLUS SECOND THROUGH FIFTH YEAR LIMITED FROM DATE OF INSTALLATION.	Replacement of the electric burner if found to be defective in materials or workmanship.	B. Repairs when oven is used in other than normal home use.
<b>TEN YEAR LIMITED WARRANTY</b> ONE YEAR FULL PLUS SECOND THROUGH TENTH YEAR LIMITED FROM DATE OF INSTALLATION.	Replacement of the porcelain oven cavity/inner door if the part rusts through due to defective materials or workmanship.	C. Damage resulting from accident, alteration, misuse, abuse, improper installation or installation not in accordance with local electrical codes. D. Any labor cost during the limited warranty. E. Replacement parts or repair labor costs for units operated outside the United States. F. Pickup and delivery. This product is designed to be repaired in the home.

**KITCHENAID, INC. DOES NOT ASSUME ANY RESPONSIBILITY FOR INCIDENTAL OR CONSEQUENTIAL DAMAGES.** Some states do not allow the exclusion or limitation of incidental or consequential damages, so this exclusion or limitation may not apply to you.

This warranty gives you specific legal rights and you may also have other rights which vary from state to state.

KitchenAid, Inc.  
St. Joseph, Michigan 49085, U.S.A.