



User's Information Manual

NOTE TO INSTALLER:

This manual should be left with the equipment owner.

TABLE OF CONTENTS

SAFETY CONSIDERATIONS	1
DETERMINE TYPE OF UNIT CONTROL	2
TO LIGHT UNIT	2
Units With Electro-Mechanical Control	2
Units With <i>ComfortLink</i> ™ Control	3
TO SHUT UNIT OFF	6
Units With Electro-Mechanical Control	6
Units With <i>ComfortLink</i> ™ Control	6
MAINTAINING YOUR UNIT	9
ROUTINE MAINTENANCE AND CARE FOR THE EQUIPMENT OWNER	9
Air Filter(s)	9
Alarm Status (Units with <i>ComfortLink</i> Control)	10
Integrated Gas Controller (IGC)	10
Combustion Area and Vent System	10
Heat Exchanger	10
Evaporator, Condenser and Combustion Fan Motors	10
Indoor Fan, Belt and Pulleys	10
Indoor Fan Shaft Bearings (Sizes 03-14)	10
Indoor Fan Shaft Bearings (Size 16)	10
Refrigerant Circuits	10
Evaporator and Condenser Coils	10
Condensate Drain	10
Compressors	11
Condenser Fan	11
Electrical Controls and Wiring	11
Unit Panels	11
REGULAR DEALER MAINTENANCE	11
BEFORE YOU CALL FOR SERVICE CHECK FOR SEVERAL EASILY SOLVED PROBLEMS	11
If insufficient heating or cooling is suspected	11
If your unit is not operating at all	11
IN CASE OF TROUBLE	11

SAFETY CONSIDERATIONS

Improper installation, adjustment, alteration, service, maintenance, or use can cause fire, electrical shock, or other conditions which may cause personal injury or property damage. Consult a qualified installer, service agency or your distributor or branch for information or assistance. The qualified installer or agency must use factory-authorized kits or accessories when modifying this product. Refer to the individual instructions packaged with the kits or accessories when installing.

Follow all safety codes. Wear safety glasses and work gloves. Have fire extinguishers available.

Recognize safety information. This is the safety-alert symbol . When you see this symbol on the furnace and in instructions or manuals, be alert to the potential for personal injury.

Understand the signal words DANGER, WARNING, and CAUTION. These words are used with the safety-alert symbol. DANGER identifies the most serious hazards which **will** result in severe personal injury or death. WARNING signifies a hazard which **could** result in personal injury or death. CAUTION is used to identify unsafe practices which **may** result in minor personal injury or product and property damage. NOTE is used to highlight suggestions which **will** result in enhanced installation, reliability, or operation.

WARNING

FIRE, EXPLOSION HAZARD

Failure to follow this warning could result in personal injury, death and/or property damage.

Do not store or use gasoline or other flammable vapors and liquids in the vicinity of this or any other appliance.

What to do if you smell gas:

1. DO NOT try to light any appliance.
2. DO NOT touch any electrical switch or use any phone in your building.
3. Leave the building immediately.
3. IMMEDIATELY call your gas supplier from a neighbor's phone. Follow the gas supplier's instructions.
4. If you cannot reach your gas supplier, call the fire department.

Installation and service must be performed by a qualified installer, service agency or the gas supplier.

Always keep the unit's area clear of combustible materials. Do not obstruct the air openings to the unit. Air is required for combustion and ventilation proper operation. Follow the instruction provided in this book for lighting and shutting down the unit. Should the gas supply fail to shut off or if overheating occurs, shut off the gas valve to the unit before shutting off the electrical supply. The following inspections must be completed post unit installation. The detailed routine maintenance inspections are in the Maintaining Your Unit section.

Post Unit Installation Inspection:

1. All flue and vent connections are clear and free of obstructions, are leak free, and not damaged.
2. Duct connections are leak free and physically sound.
3. The unit base support is free of cracks, gaps, etc.
4. There are no signs of furnace deterioration.
5. Burners are aligned correctly.
6. Follow routine maintenance inspection.

⚠ WARNING

FIRE, EXPLOSION HAZARD

Failure to follow this warning could result in personal injury and/or death.

Improper installation, adjustment, alteration, service or maintenance can cause injury or property damage. Refer to this manual. For assistance or additional information, consult a qualified installer, service agency or the gas supplier.

⚠ WARNING

FIRE, EXPLOSION HAZARD

Failure to follow this warning could result in personal injury, death and/or property damage.

Burners will light automatically. Do not attempt to light by hand.

Your combination heating/cooling unit is equipped with direct spark ignition and induced draft power combustion blower.

⚠ WARNING

FIRE, EXPLOSION HAZARD

Failure to follow this warning could result in personal injury, death and/or property damage.

Burners will light automatically. Do not attempt to light by hand.

⚠ WARNING

ELECTRICAL OPERATION HAZARD

Failure to follow this warning could result in personal injury, death and/or property damage.

Do not use this unit if any part has been under water. A flood-damaged unit is extremely dangerous. Attempts to use the unit can result in fire or explosion. A qualified service agency should be contacted to inspect the unit and replace any parts that have been wet or the unit, if deemed necessary.

DETERMINE TYPE OF UNIT CONTROL

The procedures used to light or shut off the unit depend on the type of unit control. This section will help determine the control type of the unit.

Electro-Mechanical Control

These units may be controlled directly by a thermostat, or indirectly by a third-party control that connects to the thermostat inputs. For direct thermostat control, use the Electro-Mechanical Control procedures in this book. For units with third-party controls connected to the thermostat inputs, refer to the third-party control instructions for procedures to ensure complete unit shut off.

ComfortLink™ Control

These units have a factoryinstalled Carrier *ComfortLink* control. A Scrolling Marquee display is located on the front of the unit control box behind the control box and compressor access door. These units may be controlled directly by a thermostat, directly by a space temperature sensor, or indirectly through other Carrier Comfort Network® (CCN) communication devices. To ensure complete unit shut off, use the *ComfortLink* Control procedures in this book.

TO LIGHT UNIT

(UNITS WITH ELECTRO-MECHANICAL CONTROL)

⚠ DANGER

FIRE, EXPLOSION HAZARD

Failure to follow this warning could result in personal injury or death.

1. Do not turn off the electrical power to unit without first turning off the gas supply and applying lockout tags.
2. Before attempting to start the gas heating section, familiarize yourself with all the procedures that must be followed.
3. Never attempt to manually light the burners on the unit with a match, lighter, or any other flame. If the electric sparking device fails to light the burners, refer to the shutdown procedures, then call your dealer as soon as possible.

See Fig. 1. for location of gas valve. Refer to Fig. 2 while proceeding with the following steps:

Step 1 — Set room thermostat to the lowest temperature setting and set SYSTEM switch to OFF position.

Step 2 — Close the shutoff valve on the gas supply piping.

Step 3 — Turn off the electrical supply to the unit and install lockout tag.

Step 4 — Open the heat section access panel.

Step 5 — Move ON/OFF switch on the internal main gas valve to the OFF position an

Step 6 — Move ON/OFF switch on internal main gas valve to ON position.

Step 7 — Close the heat section access panel.

Step 8 — Remove lockout tag and turn on the electrical supply to unit.

Step 9 — Open the shutoff valve on the external gas supply piping.

Step 10 — Set room thermostat selector slightly above room temperature and set system switch to HEAT position to start the unit. The induced-draft combustion air fan will start. Main burners light within 30 seconds. Indoor blower will start within 60 to 90 seconds of main gas ignition.

Step 11 — Set the temperature selector on room thermostat to desired setting.

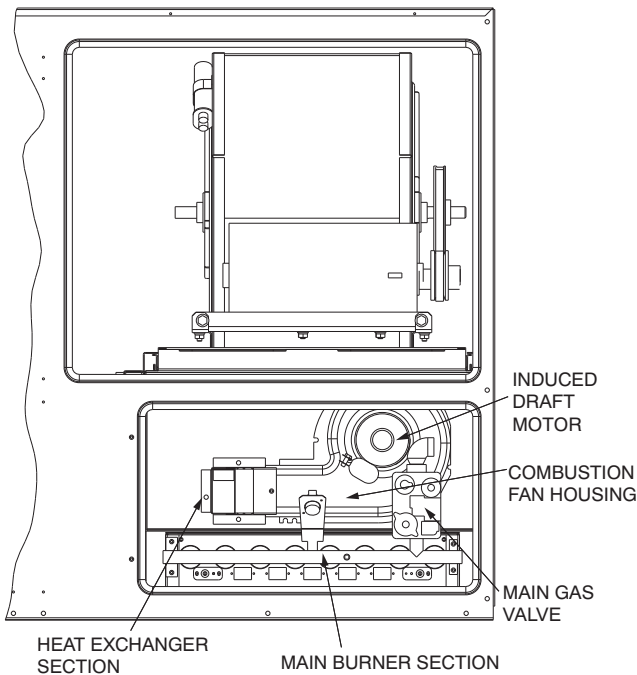

Fig. 1 - Typical Gas Heating Section

C06258

See Fig. 1. for location of gas valve. Refer to Fig. 3 while proceeding with the following steps:

Step 1 — Turn off the unit by using the Scrolling Marquee to put the unit into Service Test mode. The Scrolling Marquee is located on the front of the unit control box behind the control box and compressor access door. Thermostat inputs and remote network commands are ignored when Service Test mode is ON.

NOTE: A password may be required to change Service Test values, depending on previous settings configured in the unit. Default password is “1111.”

- a. Press the ESCAPE key until a blank screen is shown.
- b. Use the arrow keys to scroll the red LED on the display to the “Service Test” position and press ENTER.
- c. The control will display the Field Service Test Mode (TEST) setting. Press ENTER once to select the TEST setting for configuration. Press ENTER again for “OFF” to begin flashing.
- d. Use the arrow keys to change the configuration from “OFF” to “ON,” then press ENTER to save the setting.

Step 2 — Close the shutoff valve on the gas supply piping.

Step 3 — Turn off the electrical supply to the unit and install lockout tag.

Step 4 — Open the heat section access panel.

Step 5 — Move ON/OFF switch on the internal gas valve to the OFF position and wait 5 minutes.

Step 6 — Move ON/OFF switch on internal gas valve to ON position.

Step 7 — Close the heat section access panel.

Step 8 — Remove lockout tag and turn on the electrical supply to unit.

NOTE: Normal operation will automatically begin. Service Test mode will automatically end (exit) after a recycle of power.

Step 9 — Open the shutoff valve on the external gas supply piping.

Step 10 — To test the operation of the gas section, the HEAT submenu of Service Test may be used. See the Controls, Start-Up, Operation, Service, and Troubleshooting Instructions for more details on use of Service Test.

Step 11 — For normal operation, make sure that the set points are at the normal heat set points.

⚠ WARNING

FIRE, EXPLOSION HAZARD

Failure to follow this warning could result in personal injury, death, and/or property damage.

If the main burners fail to light, or the blower fails to come on, shut down gas heating section and call your dealer for service.

TO LIGHT UNIT

(UNITS WITH COMFORTLINK™ CONTROL)

⚠ DANGER

FIRE, EXPLOSION HAZARD

Failure to follow this warning could result in personal injury, death, and/or property damage.

1. Do not turn off the electrical power to unit without first turning off the gas supply and applying lockout tags.
2. Before attempting to start the gas heating section, familiarize yourself with all the procedures that must be followed.
3. Never attempt to manually light the burners on the unit with a match, lighter, or any other flame. If the electric sparking device fails to light the burners, refer to the shutdown procedures, then call your dealer as soon as possible.

⚠ WARNING

FIRE, EXPLOSION HAZARD

Failure to follow this warning could result in personal injury, death, and/or property damage.

If the main burners fail to light, or the blower fails to come on, shut down gas heating section and call your dealer for service.

48PD, 48PG

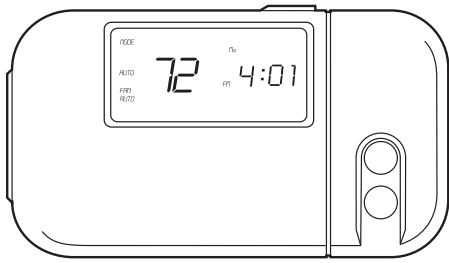

STEP 1

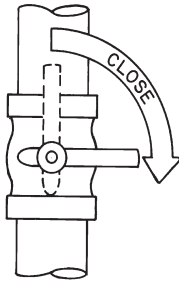

STEP 2

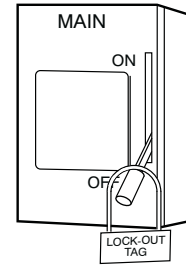

STEP 3

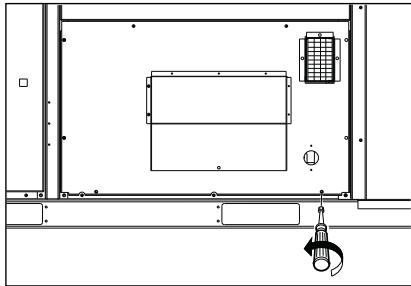

STEP 4

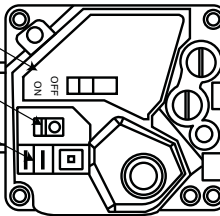
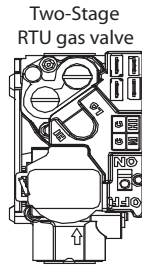

STEP 5

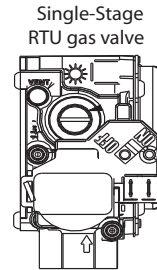

On/Off Switch

On/Off Switch

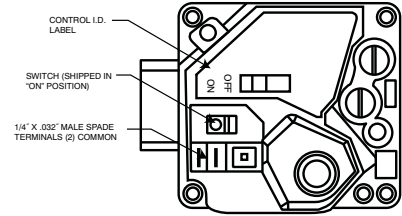

STEP 6

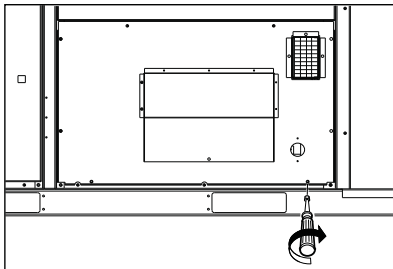

STEP 7

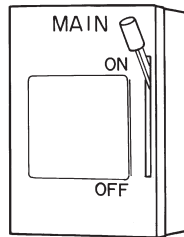

STEP 8

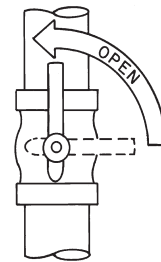

STEP 9

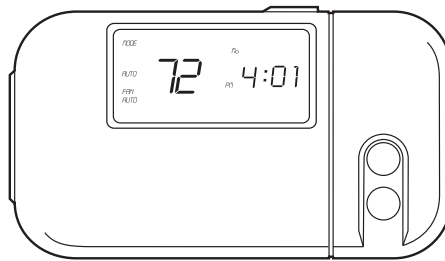

STEP 10

Fig. 2 - To Light Unit (Units with Electro-Mechanical Control)

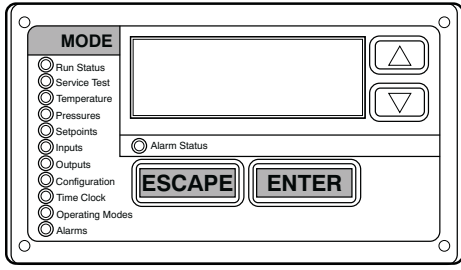

STEP 1

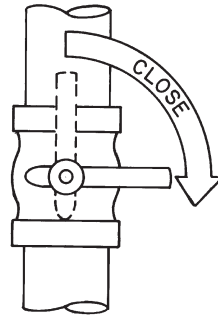

STEP 2

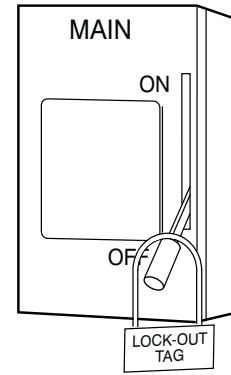

STEP 3

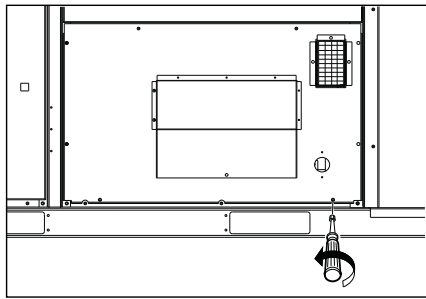

STEP 4

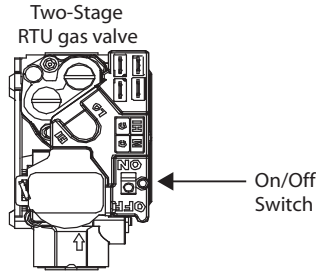

STEP 5

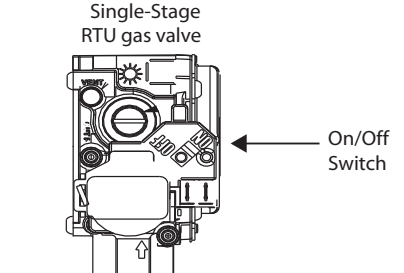

STEP 6

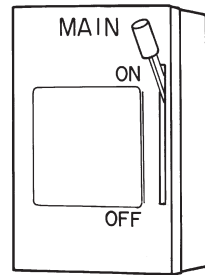
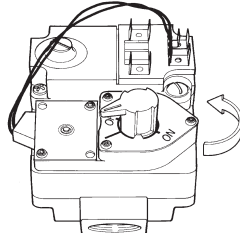

STEP 8

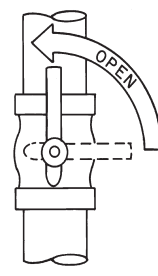
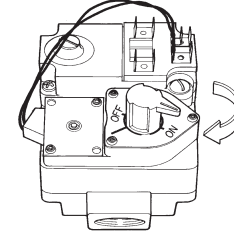

STEP 9

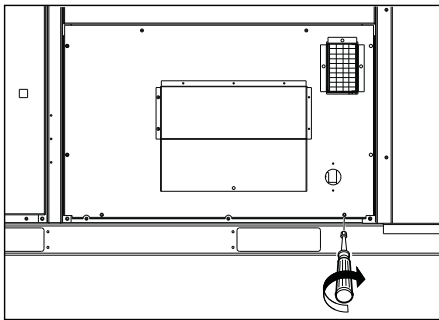

STEP 7

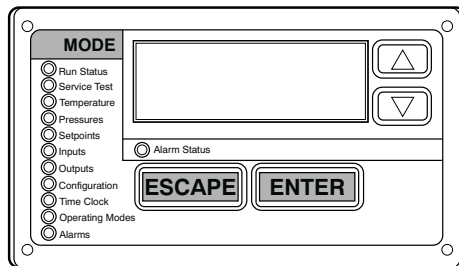

STEP 10

48PD, 48PG

Fig. 3 - To Light Unit (Units with ComfortLink™ Control)

**TO SHUT UNIT OFF
(UNITS WITH ELECTRO-MECHANICAL
CONTROL)**

⚠ WARNING

FIRE HAZARD

Failure to follow this warning could result in personal injury, death, and/or property damage.

Do not turn off the electrical power to unit without first turning off the gas supply. Should the gas supply fail to shut off or if overheating occurs, shut off the gas valve to the unit before shutting off the electrical supply. Make sure to apply lockout tags.

See Fig. 1. for location of gas valve. Refer to Fig. 4 while proceeding with the following steps:

Step 1 — Set room thermostat to lowest temperature setting and set SYSTEM switch to OFF position.

Step 2 — Close the shutoff valve on the external gas supply piping.

Step 3 — Turn off the electrical power supply to the unit and install lockout tag.

Step 4 — Open the heat section access panel.

Step 5 — Move ON/OFF switch on the internal gas valve to the OFF position.

Step 6 — Close the heat section access panel.

Step 7 — If unit is being shut down because of a malfunction, call your dealer as soon as possible.

If unit is being shut down because the heating season has ended, restore electrical power to the unit to ensure operation of the cooling system during the cooling season.

**TO SHUT UNIT OFF
(UNITS WITH COMFORTLINK™
CONTROL)**

⚠ WARNING

FIRE HAZARD

Failure to follow this warning could result in personal injury, death, and/or property damage.

Do not turn off the electrical power to unit without first turning off the gas supply. Should the gas supply fail to shut off or if overheating occurs, shut off the gas valve to the unit before shutting off the electrical supply. Make sure to apply lockout tags.

See Fig. 1. for location of gas valve. Refer to Fig. 5 while proceeding with the following steps:

Step 1 — Turn off the unit operation by using the Scrolling Marquee to put the unit into Service Test mode. The Scrolling Marquee is located on the front of the unit control box behind the control box and compressor access door. (See Fig. 6.) Thermostat inputs and remote network commands are ignored when Service Test mode is ON.

NOTE: A password may be required to change Service Test values, depending on previous settings configured in the unit. Default password is “1111.”

- a. Press the ESCAPE key until a blank screen is shown.
- b. Use the arrow keys to scroll the red LED on the display to the “Service Test” position and press ENTER.
- c. The control will display the Field Service Test Mode (TEST) setting. Press ENTER once to select the TEST setting for configuration. Press ENTER again for “OFF” to begin flashing.
- d. Use the arrow keys to change the configuration from “OFF” to “ON,” then press ENTER to save the setting.

Step 2 — Close the shutoff valve on the external gas supply piping.

Step 3 — Turn off the electrical power supply to the unit and install lockout tag.

Step 4 — Open the heat section access panel.

Step 5 — Move ON/OFF switch on the internal gas valve to the OFF position.

Step 6 — Close the heat section access panel.

Step 7 — If unit is being shut down because of a malfunction, call your dealer as soon as possible. If unit is being shut down because the heating season has ended, restore electrical power to the unit to ensure operation of the cooling system during the cooling season.

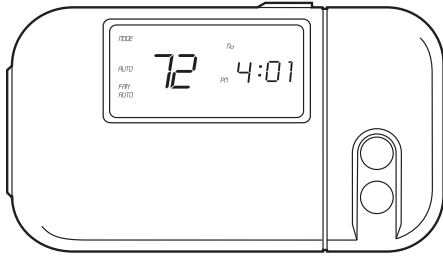

STEP 1

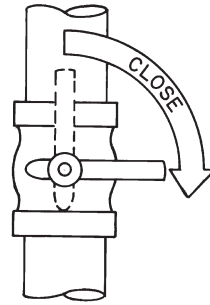

STEP 2

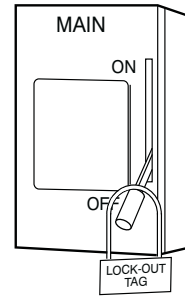

STEP 3

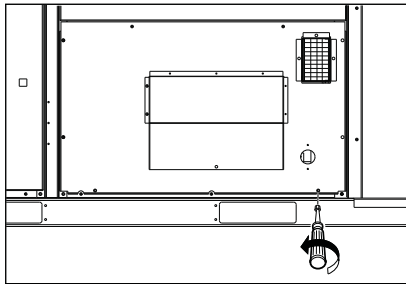

STEP 4

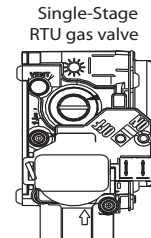
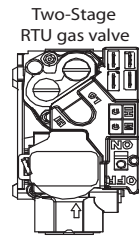

On/Off Switch

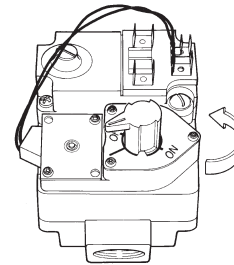

STEP 5

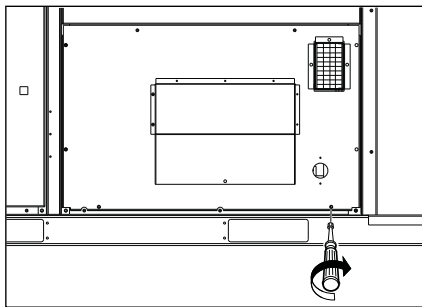

STEP 6

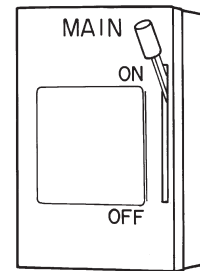

STEP 7

48PD, 48PG

Fig. 4 - To Shut Unit Off (Units with Electro-Mechanical Control)

C08543

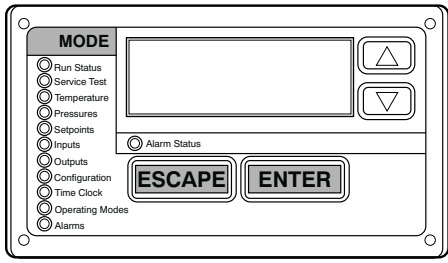

STEP 1

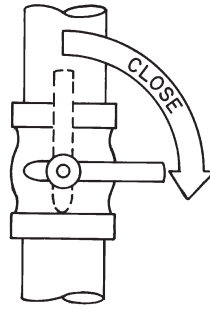

STEP 2

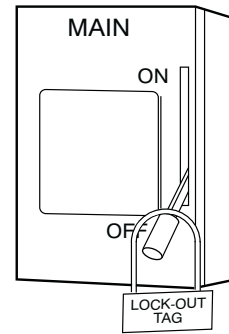

STEP 3

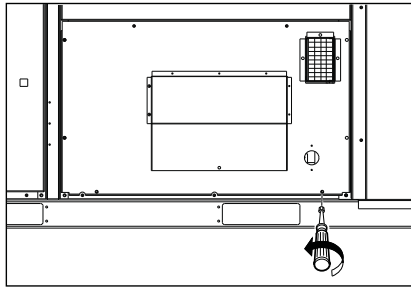

STEP 4

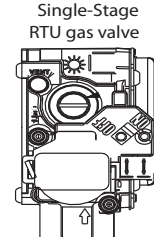
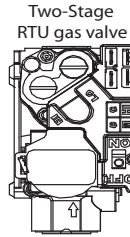

On/Off Switch

On/Off Switch

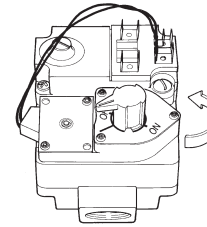

STEP 5

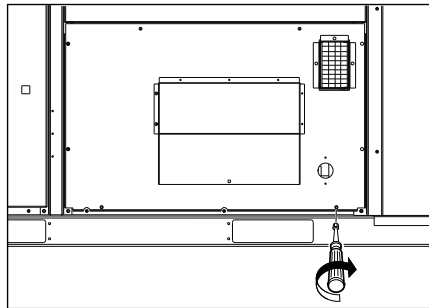

STEP 6

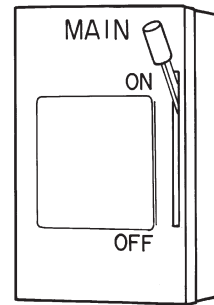

STEP 7

Fig. 5 - To Shut Unit Off (Units with *ComfortLink™* Control)

C08544

48PD, 48PG

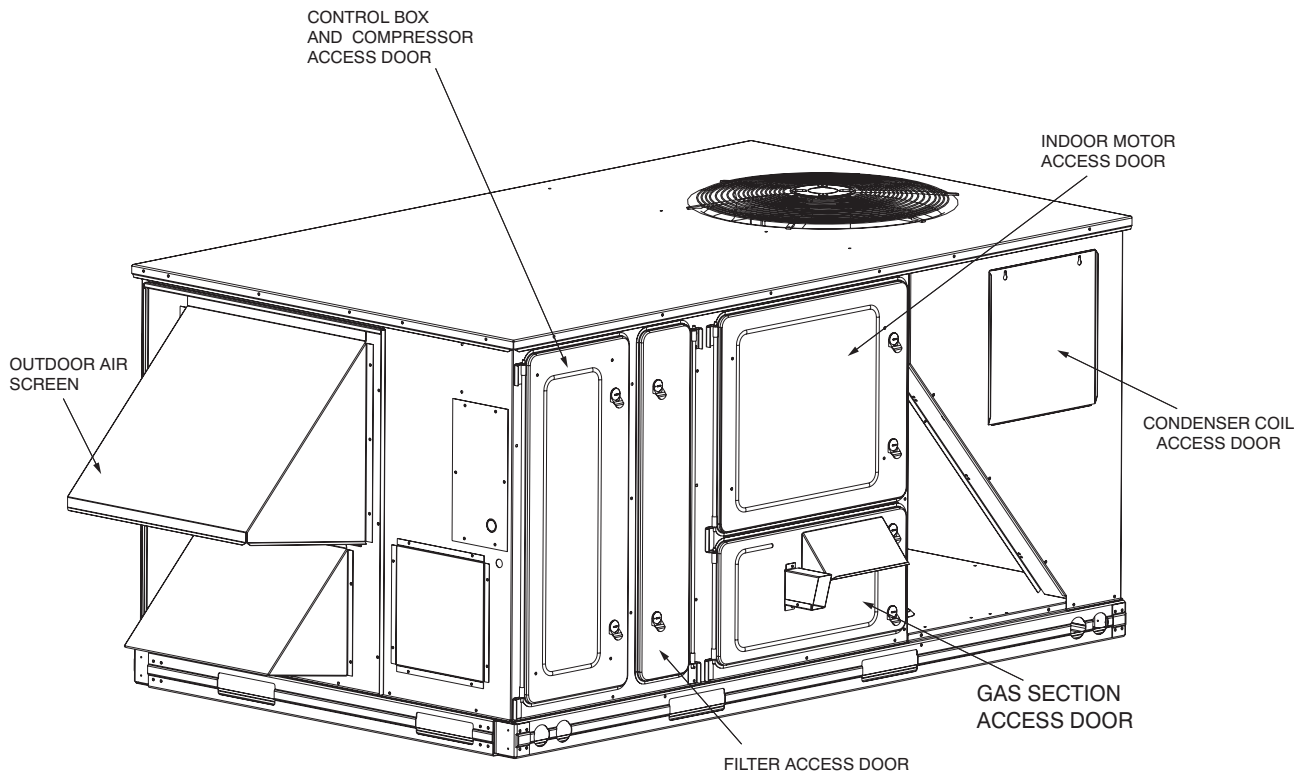

Fig. 6 - Panel and Filter Locations (48PG03-07 Shown)

C08545

48PD, 48PG

MAINTAINING YOUR UNIT

All maintenance should be handled by skilled, experienced personnel. Your dealer can help you establish a standard procedure. For your safety, keep the area around the unit clear and free of combustible materials, gasoline and other flammable liquids and vapors.

To assure proper functioning of the unit, flow of combustion and ventilating air must not be obstructed from reaching the unit. Clearance of at least 6 ft on all sides is required.

ROUTINE MAINTENANCE AND CARE FOR THE EQUIPMENT OWNER

Before proceeding with those things you might want to maintain yourself, please carefully consider the following:

⚠ WARNING

FIRE, EXPLOSION HAZARD

Failure to follow this warning could result in personal injury, death, and/or property damage.

1. Turn off gas supply and electrical power to your unit before servicing or performing maintenance.
2. Do not turn off electrical power to this unit without first turning off gas supply and applying lockout tags.
3. When removing access doors or performing maintenance functions inside your unit, be aware of sharp sheet metal parts and screws. Although special care has been taken to reduce sharp edges to a minimum, be extremely careful when handling parts or reaching into the unit.

Air Filter(s)

Air filters should be checked at least every 3 or 4 weeks and changed or cleaned whenever they become dirty. Table 1 indicates the correct filter size for your unit. Open the filter access panel to replace or inspect the filters. All units have filter tracks into which the filters slide. Remove the filters by pulling the filter slide outward from the track. See Fig. 6 for filter access panel location. Note the direction of flow arrows on the filter frame.

If you have difficulty in locating your air filter in the return-air duct system, or if you have questions concerning proper filter maintenance, contact your dealer for instructions. When replacing your unit filters, always use the correct size and quantity as shown in Table 1. Filter tracks are field convertible for 2 or 4-in. thick filters. Verify airflow and duct static values, and related motor sizing and belt drive adjustment, if filter type or efficiency rating is changed from the original installation.

Units with outdoor air capability have cleanable screens for the outdoor air. These screens should be checked annually and cleaned as necessary.

⚠ WARNING

FIRE AND EQUIPMENT DAMAGE HAZARD

Failure to follow this warning could result in personal injury, death, and/or property damage.

Never operate unit without filters in place. Damage to blower motor and/or compressors could result. An accumulation of dust and lint on internal parts of your unit can cause loss of efficiency and in some cases, fire.

Table 1 – Indoor Air Filter Data

UNIT SIZE	FILTER QUANTITY	FILTER SIZE
03–07	4	16 x 20 x (2 or 4) in (406.4 x 508 x [50.8 or 101.6]) mm
08–14	4	20 x 25 x (2 or 4) in (508 x 635 x [50.8 or 101.6]) mm
16	8	20 x 20 x (2 or 4) in (508 x 508 x [50.8 or 101.6]) mm

Alarm Status (Units with ComfortLink™ Controls)

The Scrolling Marquee display incorporates an Alarm Status LED that turns on to indicate an active alarm or alert. These alarms and alerts are in addition to those that are indicated by the Integrated Gas Control (IGC). The ComfortLink control active alarm codes and alarm history can be viewed with the Scrolling Marquee or other Carrier Comfort Network® (CCN) devices. Alarms may also be configured to broadcast automatically on CCN. If the unit will not operate and the Alarm Status LED is on, contact the local dealer and request service.

Integrated Gas Controller (IGC)

The IGC board incorporates an LED that emits a flashing light to indicate an alarm code. If the furnace section will not operate and the LED is flashing a code (1 to 9 flashes in succession), contact your dealer and request service.

NOTE: Make note of the flash code before powering off the unit. The alarm codes clear after power cycle.

Combustion Air and Vent System

The combustion area and vent system should be visually inspected before each heating season. The normal accumulation of dirt, soot, rust, and scale can result in loss of efficiency and improper performance if allowed to build up.

⚠ WARNING

FIRE HAZARD

Failure to follow this warning could result in personal injury, death, and/or property damage.

If your unit makes and especially loud noise when the main burners are ignited, shut down the heating section and call your dealer.

See Fig. 1 and proceed as follows to inspect the combustion area and power-venting system of your unit.

- Turn off electrical power (install disconnect tag) and gas supply to your unit (follow Shut-Off Steps 1-3).
- Open burner compartment access panel.
- Using a flashlight, carefully inspect the burner areas for dirt, soot, or scale.

⚠ CAUTION

EQUIPMENT DAMAGE HAZARD

Failure to follow this caution may result in damage to unit.

If dirt, soot, rust or scale accumulations are found, call your dealer and do not operate your heating section.

- When you have completed your inspection, follow the start-up procedures in this manual to restore your unit to operation.
- Observe unit heating operation, and watch the burner flame with the access panel removed to see if it is bright blue. If you observe a suspected malfunction, or that the burner flames are not bright blue, call your dealer. Some yellow flame may be present due to the panel being removed.
- Close burner compartment access panel.

Heat Exchanger

To ensure dependable and efficient heating operation, the heat exchanger should be checked by a qualified maintenance person before each heating season, and cleaned when necessary. This checkout should not be attempted by anyone not having the required expertise and equipment to do the job properly. Checking and/or cleaning the heat exchanger involves removing the gas controls assembly and the flue collector box cover and, when completed, reinstalling the gas controls assembly for proper operation. The flue collector box cover must be reinstalled with “red” RTV correctly so that a proper seal is maintained. Contact your dealer for the required periodic maintenance.

Evaporator, Condenser and Combustion Fan Motors

The indoor fan, outdoor fan, and combustion fan motors have permanently sealed bearings, so no field lubrication is necessary.

Indoor Fan, Belt and Pulleys

Check quarterly the condition of the fan wheel(s), pulleys, fan belt and the belt tension. If there is any loose part or belt wear, contact your dealer and request service.

Indoor Fan Shaft Bearings (Sizes 03-14)

The indoor fan has permanently sealed bearings, so no field lubrication is necessary.

Indoor Fan Shaft Bearings (Size 16)

Lubricate bearings at least every 6 months with suitable bearing grease. Typical lubricants are given below:

MANUFACTURER	LUBRICANT
Texaco	Regal AFB-2*
Mobil	Mobilplex EP No. 1
Sunoco	Prestige 42
Texaco	Multifak 2

* Preferred lubricant because it contains rust and oxidation inhibitors.

Refrigerant Circuits

The refrigerant circuits are difficult to check for leaks without the proper equipment; therefore, if inadequate cooling is suspected, contact your dealer for service.

Evaporator and Condenser Coils

Cleaning of the coils should only be done by qualified service personnel. This procedure should be performed prior to cooling operation or more frequently should conditions require. Contact your dealer for the required annual maintenance.

Condensate Drain

The drain pan and condensate drain line should be checked and cleaned at the same time the cooling coils are checked by your dealer.

Compressors

All compressors are factory shipped with a normal charge of the correct type refrigerant grade oil. No field lubrication is necessary except possibly with repair or replacement of refrigerant circuit components.

Condenser Fan

WARNING

PERSONAL INJURY HAZARD

Failure to follow this warning could result in personal injury or death.

Do not poke sticks, screwdrivers, or other object into revolving fan blades.

The fan must be kept free of all obstructions to ensure proper cooling. Contact your dealer for any required service.

Electrical Controls and Wiring

Electrical controls are difficult to check without proper instrumentation; therefore, if there are any discrepancies in the operating cycle, contact your dealer and request service.

Unit Panels

After performing any maintenance or service on the unit, be sure all panels are securely fastened in place to prevent rain from entering unit cabinet and to prevent disruption of the correct unit airflow pattern.

REGULAR DEALER MAINTENANCE

In addition to the type of routine maintenance you might be willing to perform, your unit should be inspected regularly by a properly trained service technician. An inspection (preferably each year, but at least every other year) should include the following:

1. Inspection of all flue product passages - including the burners, combustion baffles, heat exchanger, flue collector box, and vent pipe.
2. Inspection of all combustion-air and ventilation-air passages and openings.
3. Close inspection of all gas pipes leading to and inside your unit.
4. Inspection, and if required, cleaning of the condenser and evaporator coils.
5. Inspection, and if required, cleaning of the evaporator drain pan.
6. Inspection, cleaning, and lubrication of blower wheel housing and motor.
7. Inspection of all supply-air and return-air ducts for leaks, obstructions, and insulation integrity. Any problems found should be resolved at this time.
8. Inspection of the unit base to ensure that no cracks, gaps, etc., exist which may cause a hazardous condition.
9. Inspection of the unit casing for signs of deterioration.
10. Inspection of all electrical wiring and components to assure proper connection.
11. Inspection for leaks in the refrigerant circuit. Pressure-check to determine appropriate refrigerant charge
12. Operational check of the unit to determine working conditions. Repair or adjustment should be made at this time.
13. Your servicing dealer may offer an economical service contract that covers seasonal inspections. Ask for further details.

Complete Service Instructions can be found in the unit Installation, Start-Up and Service Instructions.

BEFORE YOU CALL FOR SERVICE, CHECK FOR SEVERAL EASILY SOLVED PROBLEMS

If insufficient heating or cooling is suspected:

() Check for sufficient airflow. Check the air filter for dirt. Check for blocked return-air or supply-air grilles. Be sure they are open and unobstructed. If these checks do not reveal the cause, call your servicing dealer.

If your unit is not operating at all, check the following list for easy solutions:

() If using a thermostat, check to be sure that your thermostat temperature selector is set above the indoor temperature during the heating season, or below the indoor temperature during the cooling season. Be sure the SYSTEM switch in the proper HEAT or COOL position and not in the OFF position.

() If *ComfortLink*™ controls are used, check Scrolling Marquee to be sure unit is not in SERVICE TEST mode. Check that set points are properly configured.

() If the alarm light is on, check what alarms are active and/or notify the dealer.

() Is the electrical supply switch on? Are any fuses blown, or has the circuit breaker tripped?

() During the heating season, check the manual gas shutoff valve. Is this lever parallel with the pipe, indicating that the valve is open? Or is the lever at the right angle, indicating that the valve is closed? If closed, has the gas been shut off for safety reasons? Otherwise, you may open the valve and follow the start-up procedures listed in this manual.

NOTE: Before proceeding with the next check, turn off the electrical power supply to the unit.

() During the heating season, check the control dial on the gas valve. Is it in the ON position? If it is not, be sure it has not been turned off for the purpose of safety. If nothing else is incorrect, follow the start-up procedures in this manual.

() If your unit still fails to operate, call your servicing dealer for troubleshooting and repairs. Specify the model and serial numbers of your unit. (Record them in this manual in the space provided.) If the dealer knows exactly which unit you have, he may be able to offer suggestions over the phone, or save valuable time through knowledgeable preparation for the service call.

IN CASE OF TROUBLE

If, after performing the above, unit performance is unsatisfactory, shut off the unit and call your dealer.

Dealer's Name: _____

Telephone No.: _____

Unit Model: _____

Unit Serial Number: _____



Turn to the Experts™

TO OBTAIN INFORMATION ON PARTS: Consult your installing dealer or classified section of your local telephone directory under the "Heating Equipment" or "Air Conditioning Contractors & Systems" heading for dealer listing by brand name.

Have available the Model No., Series Letter, & Serial No. of your equipment to ensure correct replacement part.