



ELITE

TACTICAL
PRECISION RIFLESCOPE

**This manual should only be
used for Elite Tactical Riflescopes
with illuminated reticles:**

Illuminated Mil Dot Tactical Reticle
BTR-Mil™ Bushnell Tactical Reticle
BTR-1™ Bushnell Tactical Reticle
BTR-2™ Bushnell Tactical Reticle



PROUD USA COMPANY

TABLE OF CONTENTS

Contents	Page #
Parts Guide	4-5
Fast Focus Eyepiece	6
Power Change Ring	6
Side Focus (Parallax)	6
First Focal Plane and Second Focal Plane Reticles	7
Bore Sighting and Zeroing the Scope	7-8
Elevation and Windage Target Turrets (3-12x44 & 6-24x50 models)	9-10
Elevation and Windage Finger Touch Adjustments (1-6.5x24 models)	11
Elevation and Windage T-LOK™ Turrets (ET18524)	12-13
Using the Mil Dot Reticle (ET3124F / ET6245F)	14-16
Using the BTR-Mil™ Ballistic Tactical Reticle (ET3124FJ / ET6245FJ)	17
Using the BTR-1 First Focal Plane Tactical Reticle (ET1624F)	18
Using the BTR-1 Second Focal Plane Tactical Reticle (ET1624SF)	20

TABLE OF CONTENTS

Contents	Page #
Using the BTR-2 First Focal Plane Tactical Reticle Tactical Reticle (ET1624J / ET18524)	22
Using the BTR-2 Second Focal Plane Tactical Reticle Tactical Reticle (ET1624SJ)	24
Maintenance and Storage	26
<i>Mil Dot Appendix: Using Mil Dot Reticles for Ranging</i>	27
<i>Mil Dot Appendix: Converting Trajectory Data to Mil Holdovers</i>	28
<i>Mil Dot Appendix: Cartridge Table Example</i>	29
<i>Mil Dot Appendix: Using Mil Dot Reticles for Holdover</i>	30

PARTS GUIDE

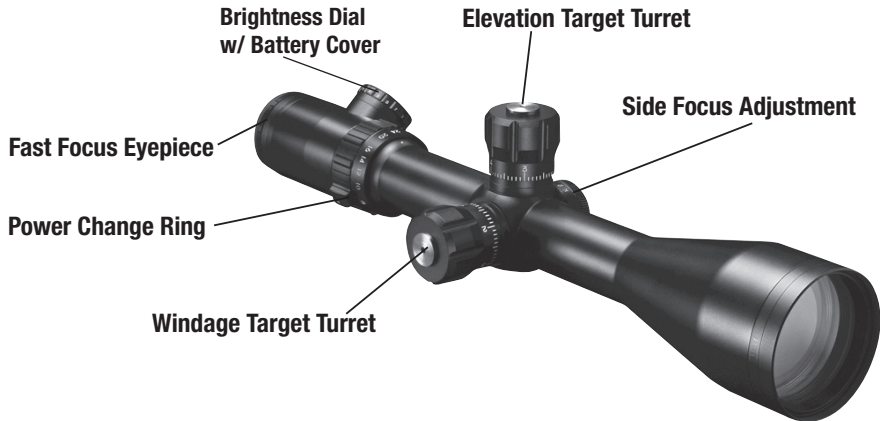

Models with Side Focus (3-12x44, 6-24x50)

PARTS GUIDE

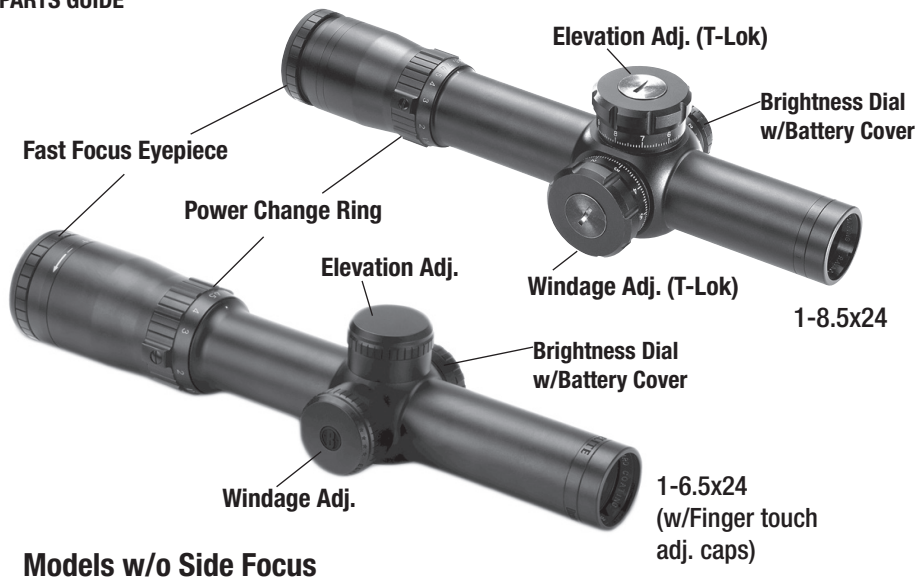

FAST FOCUS EYEPIECE

The fast-focus eyepiece dial is found on the ocular end of the Bushnell Elite Tactical Rifle scope. Use this adjustment to obtain a reticle image that appears sharp to your eyes. If adjustment is needed, look at a distant object for several seconds without using your scope. Then, shift your vision quickly, looking through the scope at a plain background. Turn the fast-focus eyepiece dial clockwise or counterclockwise until the reticle pattern is sharp and clear. *The eyepiece has a large adjustment range and should be used in conjunction with the side focus (parallax) adjustment* to obtain maximum resolution when viewing targets at long ranges (*on high power scopes that provide it).*

POWER CHANGE RING

Changing the magnification of the Bushnell Elite Tactical Rifle scope can be accomplished by grasping the knurled knob marked with the scope's magnification range (located on the far end of the ocular bell end). Turn the power change ring clockwise for higher magnifications, counterclockwise for lower magnifications. The magnification setting can be identified by noting the number that is in front of the stationary dot on the scope tube.



SIDE FOCUS *(high power models only-see Parts Guide)*

The Side Focus adjustment corrects Parallax error. Parallax error is experienced when the intended target and the reticle are not on the same focal plane. The side focus adjustment relocates an optical element within the scope, manipulating the incoming image to appear on the same focal plane as the reticle within the rifle scope, thus eliminating parallax error. Parallax error results in inconsistencies regarding point of impact. This can be best experienced by looking at a 100 yard target with the side focus set to 500 yards. While slightly moving your head left and right, or up and down, you will notice movement at the location where the crosshairs intersect. However, if you change your side focus adjustment to 100 yards while looking at the 100 yard target, the intersection of the crosshairs will not move.

Please note the distance markings on the dial are intended as reference points only. Exact side focus adjustments may be needed after making adjustments to the eyepiece in order to achieve a high resolution, parallax free image.

FIRST FOCAL PLANE AND SECOND FOCAL PLANE RETICLES

Some models of Bushnell Elite Tactical Riflescopes described in this manual have their illuminated reticles located in the first focal plane, while others place the reticle in the second focal plane. If the reticle is within the first focal plane, it will increase in size when the magnification is increased. This feature allows the continued use of the mil measurement system contained in the reticle, regardless of the power setting. Second focal plane reticles restrict the user to making measurements at a specific power, as the reticle remains the same size regardless of the magnification level.

BORE SIGHTING AND ZEROING THE SCOPE

Bore sighting is a preliminary procedure to achieve proper alignment of the scope with the rifle bore. It is best done using a Bushnell Bore Sighter. If a bore sighter is not available, it can be done as follows: Remove the bolt and sight through the gun barrel at a 100 yard target. Then sight through the scope and bring the crosshairs to the same point on the target using the turrets or windage adjustments. Return the bolt and prepare to shoot down range at the 100 yard target.

Your next step will be to zero the scope using live rounds. Fire your first shot and note the location of impact. You can use the elevation and windage adjustments to change the point of impact accordingly. For example, if your first shot went 1 mil high and 1 mil left, adjust your elevation dial down 1 Mil and your windage dial 1 mil right. Always adjust in the opposite direction from your point of impact.

As you fire your second shot, you should see the point of impact hit closer to your intended target. Multiple rounds may need to be fired before achieving consistent results. You may also use reticle within your scope to help decipher the correct adjustments. The following page shows how this works, using the BTR-Mil reticle as an example.

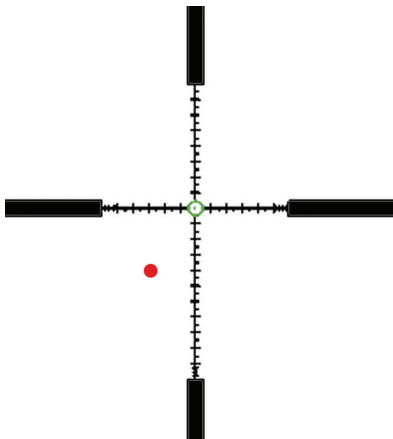

In the example to the left using the BTR-Mil reticle, the shooter was attempting to hit a target in the center of the crosshairs. The actual point of impact hit 4 Mils down and 3 Mils left, as indicated by the red dot. Adjust the elevation dial 4 Mils up/windage dial 3 Mils right. Another way to accomplish this is to return the weapon to the original aiming point on the target. Ensure that it is securely held in place. While holding the weapon steady, adjust the elevation knob until the horizontal cross hair intersects the bullet hole made by the first shot. Then adjust the windage knob until the vertical cross hair intersects the original bullet hole. The rifle scope should now be closely aligned with the bore of the weapon. It is advisable to fire additional shots as some fine adjustments may be required to insure that the firearm is perfectly zeroed.

ELEVATION AND WINDAGE TARGET TURRETS (3-12x44 & 6-24x50 MODELS)

Selected models of Bushnell Elite Tactical Riflescope with illuminated reticle feature target style adjustment turrets, which provide audible and visual references. The turrets can be rotated in either direction to make appropriate adjustments.

Each turn of the turret provides an audible “click” which coincides with a movement of the visible reference point on the turret knob. Additionally, clicks can be felt by your fingers as the turret knob moves. Each “click” represents .1 mil of reticle movement.

Rotate the elevation turret knob counterclockwise to move the reticle plane up, or clockwise to move it down. Rotate the windage dial counterclockwise to move the reticle plane right, or clockwise to move it left. These Bushnell Tactical Riflescopes provide 5 mils of adjustment per complete revolution of the turret.

After adjustments have been made, you can reset the turret to zero by following the procedure below:

REMOVING THE TARGET TURRETS

Using the included Allen wrench (hex key), loosen the turret bolt (**A**) by turning it counter-clockwise while firmly holding the turret in place. You can either remove the bolt entirely (**B**), or just loosen it enough to be able to pull up on the turret and rotate it freely in either direction (make sure the adjustment itself does not change-you don't want to lose your zero setting).

RESETTING THE DIALS TO ZERO

Once the turret bolt is loose (or removed), and you are able to pull up the elevation turret and rotate it freely, line up the “0” on the adjustment scale with the index line, then push the turret back down into place (**C**). Be careful not to lose any clicks when pushing the turret back down, which might affect your targeting at the next use. Replace the turret bolt and use the Allen wrench to tighten it (turn clockwise) until the turret is securely in place. Repeat this process with the windage turret.

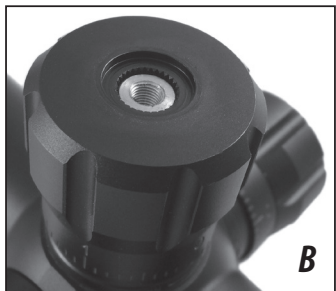

Adjustment Scale

Index Line

ELEVATION AND WINDAGE FINGER TOUCH ADJUSTMENTS (1-6.5x24 MODELS)

1-6.5x24 models of the Bushnell Elite Tactical Riflescope with illuminated reticle feature finger-adjustable, audible-click elevation and windage adjustments. To adjust the elevation or windage:

1. Remove the covers from the Elevation and Windage Adjustments.
2. Grasp the Adjustment Knob and turn it in the appropriate “UP” (and/or “R”) direction indicated by the arrows. Each “click” will change the bullet impact by .1 mil or approximately .360 inches at 100 yd. One full revolution of the turret will move the reticle 10 mils.

RESETTING THE ADJUSTMENT SCALE RING

This step is not necessary, but, for future reference, you may want to realign the zero marks on the Adjustment Scale Rings with the index dots. Simply pull the finger adjustment knob fully to the up position so that it disengages the turret splines- it should rotate freely without any audible clicks. Then rotate it back to “0” and re-seat so that the knob re-engages.

ELEVATION AND WINDAGE T-LOK™ TURRETS (ET18524)

The model# ET18524 Bushnell Elite Tactical Riflescope features T-Lok™ (locking) turrets, which provide audible and visual references. When a turret is lifted (elevated) into the upward position it can be rotated in either direction to make appropriate adjustments.

Each turn of the turret provides an audible “click” which coincides with a movement of the visible reference point on the turret knob. Additionally, clicks can be felt by your fingers as the turret knob moves. Each “click” represents .1 mil. After adjustments are made, the turret can be pushed back into the downward position to prevent movement, or left elevated and ready for further adjustments if preferred.

With the turrets pulled fully upward, rotate the elevation turret knob counterclockwise to move the reticle plane up, or clockwise to move it down. Rotate the windage dial counterclockwise to move the reticle plane right, or clockwise to move it left. These Bushnell tactical riflescopes provide 10 mils of adjustment per complete revolution of the turret. .

After adjustments have been made, you can reset the turret to zero by following the steps below (*see photos on next page*):

1. Ensure the turret is in the lock position.
2. Use a coin or flathead screwdriver to remove the turret screw found on top of the turret knob, being careful not to displace the o-ring found under the turret knob.
3. Remove the turret knob and return it to the turret, with the “zero” mark on the knob lining up with the vertical index line on the turret.
4. Return turret screw to top of knob and tighten down, making sure the turret knob is in the locked position so the turret knob does not turn while tightening the screw.

ELEVATION AND WINDAGE T-LOK™ TURRETS (ET18524)



STEP 1



STEP 2



STEP 4



STEP 3



USING THE MIL DOT RETICLE (ET3124F / ET6245F)

Your Bushnell riflescope contains a mil-dot reticle (1st focal plane), the most accurate means of range estimation using a manual optical device. These mil dots also allow precise leads for moving targets and exact compensation for shooting in a crosswind.

RETICLE DESCRIPTION

The middle of this reticle contains four evenly spaced mil-dots arrayed outward vertically and horizontally from the center. Actually, because the very center dot was left out to allow clear aiming, the reticle represents five mils in any direction -- ten vertical mils -- as shown in the illustration. Note that the most outward dot is replaced by the edge of the heavier reticle line.

One mil is the space from center-dot to center-dot. One-half and one-quarter mils are easy to estimate mentally; with practice, you can measure tenths of mils for the most exact ranging.

RANGING WITH YOUR MIL-DOT RETICLE

The mil is an angular measurement -- 1/6400th of a circle -- which equals almost precisely one yard at 1000 yards, or one meter at 1000 meters. This proportional relationship makes possible a simple formula to compute distances:

$$\frac{\text{The Measured Object's Width or Height in Yards} \times 1000}{\text{Object's Width or Height in Mil}} = \text{Range in Yards}$$

This formula works equally well with meters, but don't mix meters and yards: Measure the object in yards to find the distance in yards, use meters to yield distances in meters.

Looking through your scope, select an object at the distance you want to range -- an object whose width or height you know or can estimate accurately. Man-made objects of uniform size, such as fenceposts, are best, but any object of known dimensions will do. Measure the object's

height or width carefully in mils, compute it according to the formula and you will find its range. Support your rifle and be precise when measuring objects; any measuring error causes an error in the computed range. Equally, a mistake in estimating the object size results in a proportional range error.

Here's an example: A coyote is sunning himself in a snowfield beside a fencepost; having crossed the fence earlier, you know that the post is four feet high, or 1.33 yards. The fencepost measures 2.5 mils in your reticle.

$$\frac{1.33 \text{ yards} \times 1000}{2.5 \text{ mils}} = \frac{1330}{2.5} = 532 \text{ Yards}$$

CALCULATING HOLDS FOR WIND AND MOVING TARGETS

Your horizontal mil dots provide a precise way of holding for crosswinds and target movement. Just look in your cartridge's wind drift and moving target tables to determine the exact holds for different distances. The example table (*see pg. 17*) lists one-mil widths from 100 to 500 yards, so you can calculate how many mils to hold right or left when firing in a crosswind, or engaging a moving target.

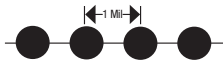

One mil is the distance between centers of dots. It's easy to measure in half-mils or even quarter-mils but with practice you can measure tenths of a mil.

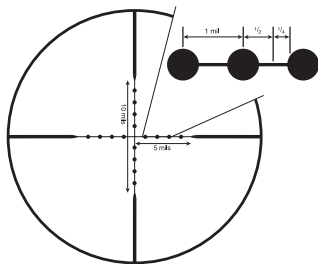

The Mil Dot Reticle Measurement System in the First Focal Plane Applies at any Magnification Level.

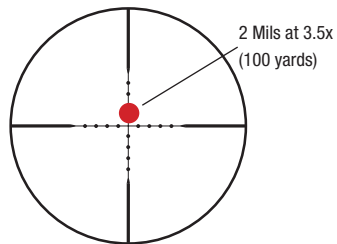
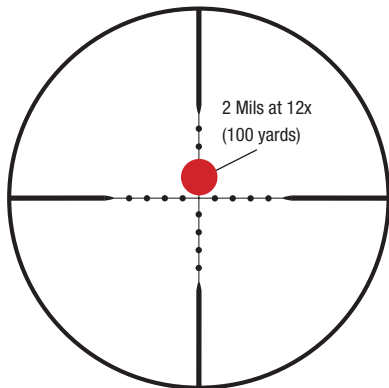

USING THE BTR-MIL™ BALLISTIC TACTICAL RETICLE (ET3124FJ / ET6245FJ)

The Bushnell BTR-Mil™ Ballistic Tactical Reticle is a hashmarked reticle that uses mrad based subtension lines for ranging, holdover and windage corrections. The illuminated 1 mil diameter circle with .1 mil center dot provides an unobstructed view of the target with 10 illumination settings.

In order to facilitate accurate holdover and windage compensation, this reticle uses hash marks spaced in 1 mil increments with .5 mil graduations. It provides a total of 10 mils of holdover below the center dot on the vertical crosshair and a total of 10 mils of subtension lines on the horizontal crosshair. There are also more precise subtensions of .2 mils on the last mil hash on both outer ends of the horizontal crosshair and on the bottom of the vertical crosshair. The BTR-Mil reticle features an illuminated center dot that spans approximately .1 mil and marks the imaginary intersection of the horizontal and vertical stadia lines. This dot is enclosed by an illuminated ring that subtends 1 mil. The thickness of this illuminated ring is .14 mils.

Because the BTR-Mil reticle is positioned in the first focal plane (FFP), reticle measurements can be used with the scope set at any magnification.

To increase the brightness of the illuminated ring, set the brightness adjustment control (*located near the eyepiece-see pg. 5*) to a higher number (opposite the white index dot). To turn off the illumination and when storing the scope, set the dial to "OFF" To replace the battery, remove the cap on the brightness adjustment control knob using a coin, and insert a CR2032 battery with the "+" mark facing up (*pg. 19, Fig. 2*).

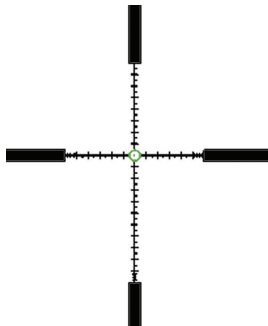

USING THE BTR-1 TACTICAL RETICLE IN A FIRST FOCAL PLANE SCOPE (ET1624F)

Elite Tactical model ET1624F with the BTR-1 Tactical Reticle is designed to be sighted-in at 100 yards (or meters), and provides hold over points out to 600 meters. This reticle is calibrated for use with 223 Rem/5.56 ammunition loaded with 55-62 grain bullets. Because the BTR-1 reticle is located in the first focal plane (FFP) position in this model, it will be accurate for all targets at any magnification setting. It also features an illumination control dial with 11 brightness settings, including 2 positions for use with night vision units.

How To Use the Reticle:

Once zeroed at 100 yards/meters, the center dot of the BTR-1 reticle is used for shots out to 200 meters, based on the 5.56/.223 Rem caliber. Below the center dot, you will find a series of four upside down “T’s” that represent 300, 400, 500, and 600 meter ranges. The “T’s” are used as a bracketing system to best fit a 12”x18” target. When acquiring your target, find the best fit bracket and send your shot. With the reticle in the first focal plane your shot can be taken at any magnification range. The versatility of the reticle can be clearly seen as the center horseshoe dot shrinks down to a single aiming point on low power, perfect for close range shooting scenarios.

Illuminated Reticle Features

The BTR-1 reticle is illuminated. The “third knob” along with elevation and windage turrets is a brightness adjustment control (not a side focus knob), numbered from 0 to 11 (**see Fig. 1, next page**). To increase the brightness, set the control to a higher number (opposite the white index dot). To turn off the illumination and when storing the scope, set the dial to any of the “Off” positions (dots) between each numbered illumination setting. To replace the battery, remove the cap on the brightness adjustment control knob using a coin, and insert a CR2032 battery with the “+” mark facing up (**Fig. 2**).

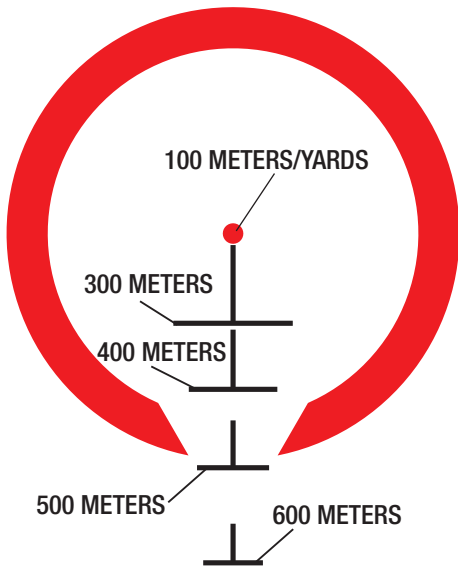

Note: the scope should be zeroed at 100 Meters/Yards



Fig. 1



Fig. 2

USING THE BTR-1 TACTICAL RETICLE IN A SECOND FOCAL PLANE SCOPE (ET1624SF)

Elite Tactical model ET1624SF with the BTR-1 Tactical Reticle is designed to be sighted-in at 100 meters/yards, and provides hold over points out to 600 meters. This reticle is calibrated for use with 223 Rem/5.56 ammunition loaded with 55-62 grain bullets. The reticle design allows accurate aiming points out to 600 meters. It also features an illumination control dial with 11 brightness settings, including 2 positions for use with night vision units.

How To Use the Reticle:

Once zeroed at 100 yards or meters, the center dot of the BTR-1 reticle is used for shots out to 200 meters, based on the 5.56/.223 Rem caliber. Below the center dot, you will find a series of four upside down “T’s” that represent 300, 400, 500, and 600 meter ranges. The “T’s” are used as a bracketing system to best fit a 12”x18” target. When acquiring your target, find the best fit bracket and send your shot. With the reticle in the second focal plane, the scope must be set at 6.5x magnification to insure the accuracy of the holdover points.

Illuminated Reticle Features

The BTR-1 reticle is illuminated. The “third knob” along with elevation and windage turrets is a brightness adjustment control (not a side focus knob), numbered from 0 to 11 (*see Fig. 1, next page*). To increase the brightness, set the control to a higher number (opposite the white index dot). To turn off the illumination and when storing the scope, set the dial to any of the “Off” positions (dots) between each numbered illumination setting. To replace the battery, remove the cap on the brightness adjustment control knob using a coin, and insert a CR2032 battery with the “+” mark facing up (*Fig. 2*).

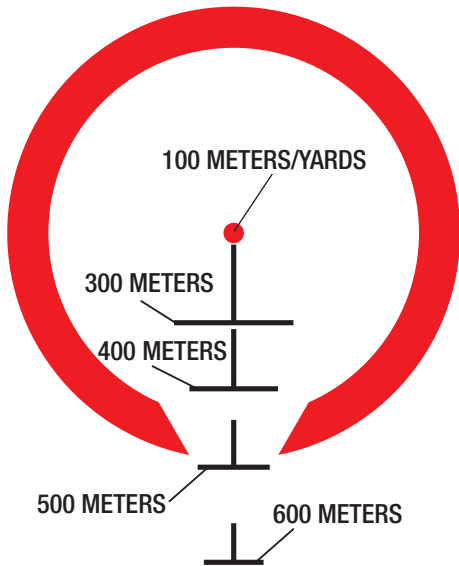

Note: the scope should be zeroed at 100 Meters/Yards



Fig. 1



Fig. 2

USING THE BTR-2 TACTICAL RETICLE IN A FIRST FOCAL PLANE SCOPE (ET1624J / ET18524)

The BTR-2 reticle in first focal plane is an excellent choice for shooters needing maximum flexibility in a riflescope. This reticle in the first focal plane combines the close range benefits of a red dot sight with the long range capabilities offered by mrad based ranging reticle. The center horseshoe provides an unobstructed aiming point that is effective in both CQB scenarios and if targets are encountered at longer ranges. At high magnification (6.5x or 8.5x) the mil hash vertical stadia offers 10 mils of elevation. Additionally the horizontal stadia can be used for windage holds or to range 10" targets out to 800 meters. (*See horizontal stadia detail, right*). The reticle also features an illumination control dial with 11 brightness settings, including 2 positions for use with night vision units.

How To Use the Reticle:

1. Sight in at 100 meters/yds on any magnification setting.
2. Determine distance to target. For the best accuracy in determining distance, utilize a Bushnell Laser Rangefinder (Scout DX 1000 ARC, G Force 1300 ARC).
3. Set the scope to any magnification and determine holdovers in mils based on the ballistics of your weapon.

Illuminated Reticle Features

The BTR-2 reticle is illuminated. The "third knob" along with elevation and windage turrets is a brightness adjustment control (not a side focus knob), numbered from 0 to 11 (**Fig. 1, p.21**). To increase the brightness, set the control to a higher number (opposite the white index dot). To turn off the illumination and when storing the scope, set the dial to any of the "Off" positions (dots) between each numbered illumination setting. To replace the battery, remove the cap on the brightness adjustment control knob using a coin, and insert a CR2032 battery with the "+" mark facing up (**Fig. 2, p.21**).

Center dot measures .3 mils at highest power setting (6.5x or 8.5x, depending on model)

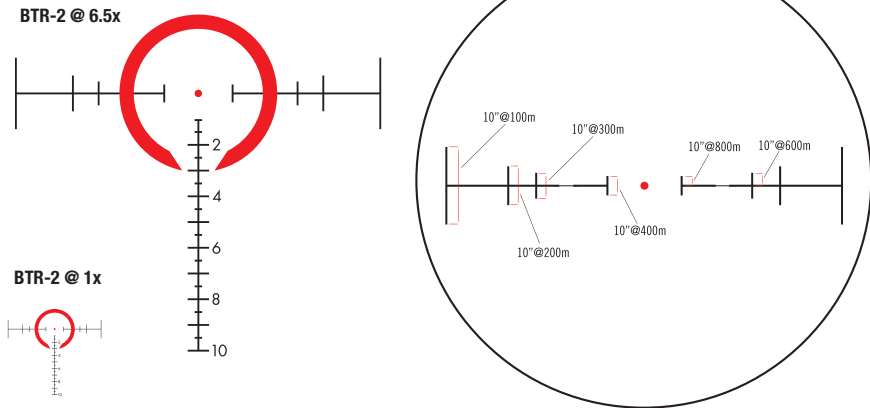

USING THE BTR-2 TACTICAL RETICLE IN A SECOND FOCAL PLANE SCOPE (ET1624SJ)

The BTR-2 reticle in second focal plane is an excellent choice for shooters needing maximum flexibility in a riflescope. This reticle in the second focal plane combines an illuminated red dot with a mil hash platform. The center horseshoe provides an unobstructed aiming point that is effective in both CQB scenarios and if targets are encountered at longer ranges. At 6.5 magnification power the mil hash vertical stadia offers 10 mils of elevation, with .5 mil hash marks in between. Additionally the horizontal stadia can be used for windage holds or to range 10" targets out to 800 meters. (*See horizontal stadia detail, right*). The reticle also features an illumination control dial with 11 brightness settings, including 2 positions for use with night vision units.

How To Use the Reticle:

1. Sight in at 100 yds at the 6.5x magnification setting.
2. Determine distance to target. For the best accuracy in determining distance, utilize a Bushnell Laser Rangefinder (Scout DX 1000 ARC, G Force 1300 ARC).
3. Ensure that the scope is set at 6.5x magnification and determine holdovers in mils based on the ballistics of your weapon.

Illuminated Reticle Features

The BTR-2 reticle is illuminated. The "third knob" along with elevation and windage turrets is a brightness adjustment control (not a side focus knob), numbered from 0 to 11 (**Fig. 1, p.21**). To increase the brightness, set the control to a higher number (opposite the white index dot). To turn off the illumination and when storing the scope, set the dial to any of the "Off" positions (dots) between each numbered illumination setting. To replace the battery, remove the cap on the brightness adjustment control knob using a coin, and insert a CR2032 battery with the "+" mark facing up (**Fig. 2, p.21**).

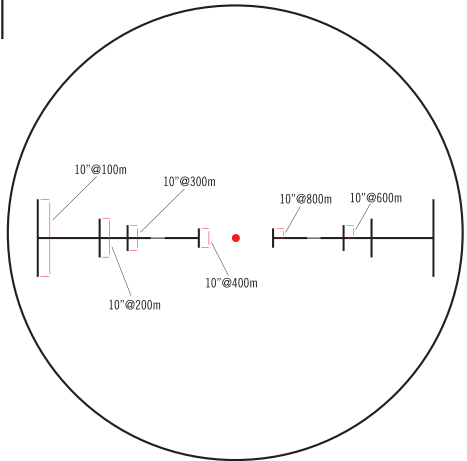
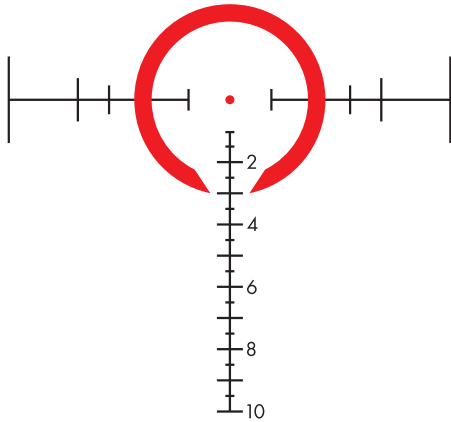

MAINTENANCE

Your Bushnell Elite Tactical riflescope, though amazingly tough, is a precision instrument that deserves reasonably cautious care.

1. When cleaning the lenses, first blow away any dry dirt and dust, or use a soft lens brush. Fingerprints and lubricants can be wiped off with lens tissue, or a soft clean cloth, moistened with lens cleaning fluid. Microfiber cleaning cloths are also recommended.

WARNING: Unnecessary rubbing or use of a coarse cloth may cause permanent damage to the lens coatings.

2. All moving parts of the scope are permanently lubricated. Do not try to lubricate them.
3. No maintenance is needed on the scope's outer surface, except to occasionally wipe off dirt or fingerprints with a soft cloth.
4. Use lens covers whenever it is convenient.

STORAGE

- Avoid storing the scope in hot places, such as the passenger compartment of a vehicle on a hot day. The high temperature could adversely affect the lubricants and sealants. A vehicle's trunk, a gun cabinet or a closet is preferable.
- Never leave the scope where direct sunlight can enter either the objective or the eyepiece lens. Damage may result from the concentration (burning glass effect) of the sun's rays.

APPENDIX: MIL DOT RANGING & HOLDOVER EXAMPLES

USING MIL DOT RETICLES FOR RANGING

The Equations:

$$\frac{\text{Size of target in yards X 1000}}{\text{Size of Target in Mils}} = \text{Range in Yards}$$

$$\frac{\text{Size of target in inches X 27.778}}{\text{Size of target in Mils}} = \text{Range in Yards}$$

$$\frac{\text{Size of target in inches X 25.4}}{\text{Size of target in Mils}} = \text{Range in Meters}$$

Example 1: Looking through the riflescope, I located a preset target that has a known size of 12"x12" square. By using the Mil Dots I measured the target to have a Mil reading of 1. What is my distance to the target?

$$\begin{array}{l} \text{Known size of target: 12"x 12"} \\ \text{Mil Reading: 1Mil} \end{array} \quad \frac{12 \text{ X } 27.778}{1 \text{ Mil}} = 333.33 \text{ Yards}$$

APPENDIX: MIL DOT RANGING & HOLDOVER EXAMPLES

Example 2: Take the same size target but now the Mil reading is .75 (from crosshair intersection to bottom of first Mil Dot).

Known size of target: 12"x 12"

Mil Reading: .75 Mil

$$\frac{12 \times 27.778}{.75 \text{ Mil}} = 444.44 \text{ Yards}$$

CONVERTING TRAJECTORY DATA TO MIL HOLDOVERS

To calculate holdovers you must first obtain your round's trajectory data. Look at the ammunition manufacturer's website, in a manufacturer's brochure, or use a ballistic software program. You will need the Bullet Path data for a 100-yard zero, in hundred-yard increments.

The following ballistic information example refers to the Federal .308 168-gr. BTHP Match Round and a 100-yard zero. The left column lists the cartridge's trajectory in inches at 100-yard increments. The next column contains the mil-size in inches at these same distances. Divide the trajectory by the mil size at each distance to find the holdover in Mils.

APPENDIX: MIL DOT RANGING & HOLDOVER EXAMPLES

FEDERAL .308 168-GR BTHP HOLDOVERS FOR A MIL-DOT RETICLE (Cartridge Table Example)

Distance	Trajectory	1 Mil Size	Actual Holdover	
100 Yards	0	0 Mils	0 Mils	
200 Yards	4.5"	7.2 Mils	.62 Mils	
300 Yards	15.9"	10.8 Mils	1.47 Mils	
400 Yards	35.5"	14.4 Mils	2.46 Mils	
500 Yards	64.6"	18.0 Mils	3.58 Mils	

$$\frac{\text{Trajectory}}{\text{Mil Size at given Distance}}$$

APPENDIX: MIL DOT RANGING & HOLDOVER EXAMPLES

USING MIL DOT RETICLES FOR HOLDOVER

Once you know how to range your target with a Mil Dot reticle, and using the previous example, you can use the reticle instead of the turrets to make adjustments with holdover. For example, your range tells you that the 12" target is 300 yards away, $(12" \times 27.778) / (1.1 \text{Mil})$. Based on the Federal .308 Win ballistic info in the previous example, you will need to hold 1.47 MILs down on the vertical crosshair and fire.

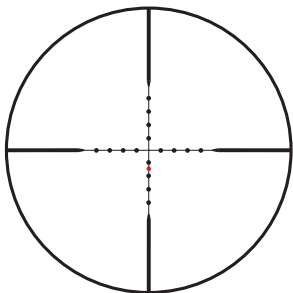

YARDS	MIL VALUE IN INCHES
100	3.6
200	7.2
300	10.8
400	14.4
500	18.0
600	21.6
700	25.2
800	28.8
900	32.4
1000	36.0

ELITE® LIFETIME LIMITED WARRANTY

We are so proud of our Bushnell® ELITE® Tactical Riflescopes that their materials and workmanship are warranted to be free of defects for the life of the ELITE Tactical Rifle. The warranty is available to any owner of the ELITE Tactical Rifle. No receipt or warranty card is required. This warranty does not cover damages caused by misuse or improper handling, installation or maintenance of the rifle.

At our option, we will repair or replace any defective ELITE Tactical Rifle, which shall be your sole remedy under this warranty. In no event shall we be liable for transportation costs to us, costs of removal or reinstallation of the rifle, or incidental or consequential damages. Some states do not allow the exclusion of limitation of incidental or consequential damages, so the above limitation or exclusion may not apply to you. No agent, representative, dealer or unauthorized employee of Bushnell has the authority to increase or alter the obligation of this warranty. Any return made under this warranty must be accompanied by the items listed below:

1. Name and address for product return
2. An explanation of the defect
3. You are responsible for transport of the defective product, but we will pay for shipping the repaired or replacement product back to you anywhere in the continental United States.
4. Product should be well packed in a sturdy outside shipping carton, to prevent damage in transit, to the following address:

In U.S.A. Send To:

Bushnell Outdoor Products
Attn.: Repairs
9200 Cody
Overland Park, Kansas 66214

In Canada Send To:

Bushnell Outdoor Products
Attn.: Repairs
25A East Pearce Street, Unit 1
Richmond Hill, Ontario L4B 2M9

For products purchased outside the United States or Canada please contact your local dealer for applicable warranty information.

In Europe you may also contact Bushnell at:

Bushnell Germany GmbH
European Service Centre
Mathias-Brüggen-Str. 80
D-50827 Köln
GERMANY
Tel: +49 221 995568-0
Fax: +49 221 995568-20

This warranty gives you specific legal rights.
You may have other rights which vary from country to country.

©2013 Bushnell Outdoor Products

Bushnell®

For further questions or additional information please contact:

Bushnell Outdoor Products
9200 Cody, Overland Park, Kansas 66214
(800) 423-3537
www.bushnell.com

©2013 Bushnell Outdoor Products