



Impressa F9

Fully Automatic
Coffee & Espresso Center
with Claris Water Care System

Operating Instructions
and Warranty

Customer Service 1-800-220-5701

63942R

IMPORTANT SAFEGUARDS

When using electrical appliances, basic safety precautions should always be followed, including the following:

1. Read all instructions.
2. Do not touch hot surfaces. Use handles or knobs.
3. To protect against fire, electric shock and personal injury, do not immerse cord, plugs or appliance in water or other liquids.
4. Close supervision is necessary when any appliance is used by or near children.
5. Unplug from outlet when not in use and before cleaning. Allow it to cool before putting on or taking off parts, and before cleaning the appliance.
6. Do not operate any appliance with a damaged cord or plug or after the appliance malfunctions, or has been damaged in any manner. Return appliance to the nearest authorized service facility for examination, repair or adjustment.
7. The use of accessory attachments not recommended by the appliance manufacturer may result in fire, electric shock, or personal injury.
8. Do not use outdoors.
9. Do not let the cord hang over the edge of a table or counter, or touch hot surfaces.
10. Do not place on or near a hot gas or electric burner, or in a heated oven.
11. Always attach plug to appliance first, then plug cord into

wall outlet. To disconnect, turn any control to “off” then remove plug from wall outlet.

12. Do not use appliance for other than intended use.
13. Use extreme caution when disposing hot steam.
14. For household use only.

SAVE THESE INSTRUCTIONS SPECIAL CORD SET INSTRUCTIONS

Regarding your cord set:

- A. A short power-supply cord (or detachable power-supply cord) is to be provided to reduce risks resulting from becoming entangled in or tripping over a longer cord.
- B. Longer detachable power-supply or extension cords are available and may be used if care is exercised in their use.
- C. If a long detachable power-supply cord or extension cord is used,
 - 1) The marked electrical rating of the detachable power-supply cord or extension cord should be at least as great as the electrical rating of the appliance,
 - 2) If the appliance is of the grounded type, the extension cord should be a rounding type 3-wire cord, and
 - 3) The longer cord should be arranged so that it will not drape over the counter-top or table-top where it can be pulled on by children or tripped over.

NOTICE: Your Impressa F9 has a 3-prong grounded plug. To reduce the risk of electrical shock this plug will fit in an outlet only one way. If the plug does not fit in the outlet contact a qualified electrician. DO NOT modify the plug in any way.

CAUTION

This appliance is for household use. Any servicing other than cleaning and user maintenance should be performed by an authorized service representative.

- Do not immerse base in water or try to disassemble.
- To reduce the risk of fire or electric shock, do not remove the base. No user serviceable parts inside. Repair should be done by authorized service personnel only.
- Check voltage to be sure that the voltage indicated on the name plate agrees with your voltage.
- Never use warm or hot water to fill the water container! Use cold water only!
- Keep your hands and the cord away from hot parts of the appliance during operation.
- Never clean with scouring powders or hard implements.

JURA-CAPRESSO

Jura was founded in 1931 in Switzerland. Capresso was founded in 1994 in the USA. Both companies have joined forces in the US to bring you the best Fully Automatic Coffee Centers available anywhere. With innovative and user-friendly features, high quality materials, clear instructions and superb customer service, we are sure you will experience the best coffee, espresso, cappuccino or latte you have ever had. We hope you will enjoy your new Fully Automatic Coffee Center and will recommend it to your friends. For more information about our products visit our website www.capresso.com.

Michael Kramm, President

Fig. 1

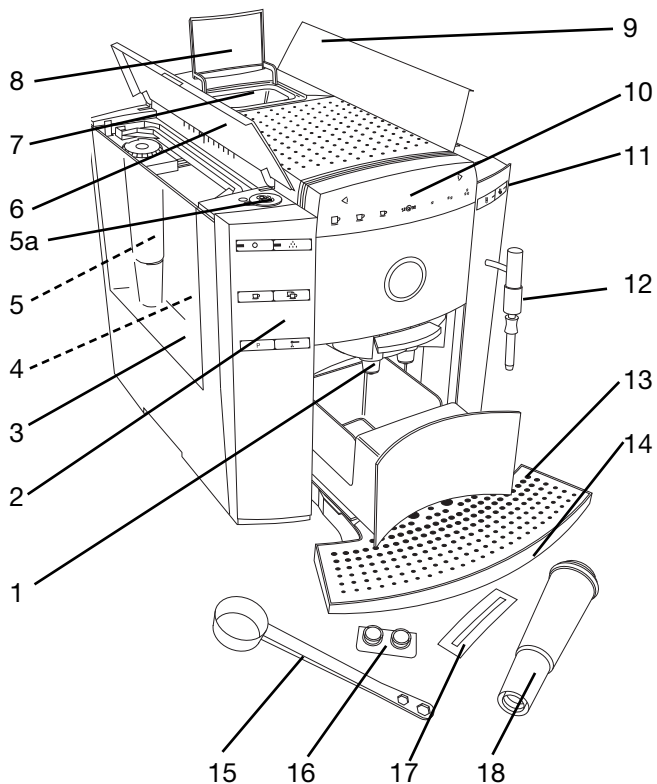

1. Height-Adjustable Coffee Spout
2. Operating Buttons (See Fig. 3)
3. Removable Water Tank
4. Low Water Flotation Device (See Fig. 8.4)
5. Claris Water Care Cartridge (Not Installed)
- 5a. Service Plug
6. Lid for Water Tank
7. Ground Coffee Funnel
8. Lid for Ground Coffee Funnel
9. Lid for Bean Container
10. Touch-screen control display (See Fig. 5)
11. Steam/Hot Water Buttons (See Fig. 4)
12. Dual Frother Plus
13. Stainless Steel Removable Grid
14. Removable Drawer
15. Measuring Scoop
16. Two Cleaning Tablets (white)
17. Water Hardness Indicator Strip
18. Claris Water Cartridge (unpacked)

Fig. 2

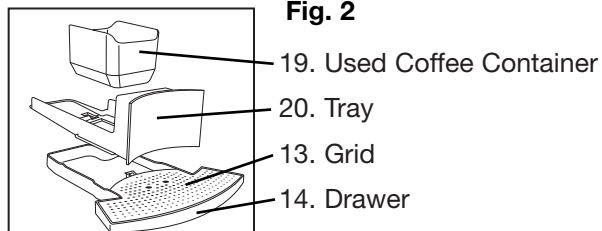

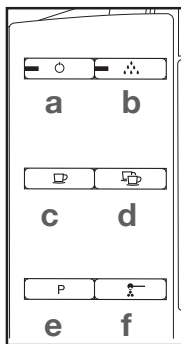

Operating Buttons

- a. On/Off
- b. Rinse
(PRESS MAINT.)
- c. 1-Cup
- d. 2-Cup
- e. Programming
- f. Pre-Ground Coffee

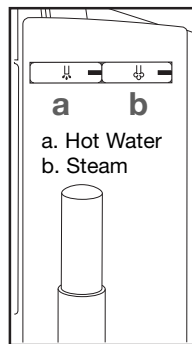

- a. Hot Water
- b. Steam



- a. BIG CUP
- b. COFFEE
- c. ESPRESSO
- d. ST@RT
- e. MILD
- f. NORMAL
- g. STRONG

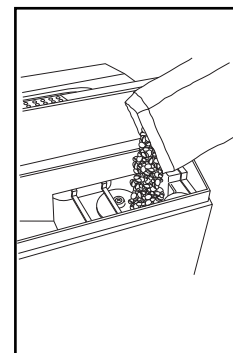

Fig. 3

Fig. 4

Fig. 5

Fig. 6

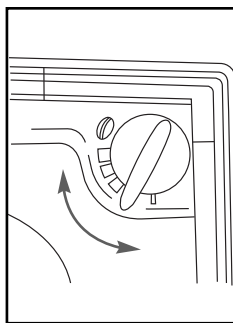

Fig. 7

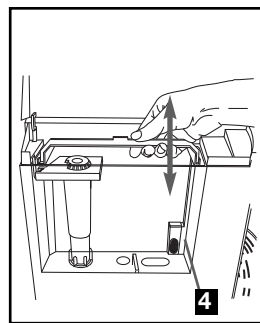

Fig. 8



Fig. 9

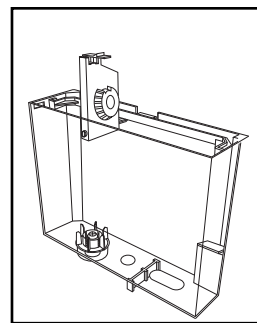

Fig. 10

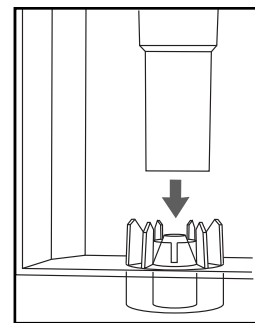

Fig. 11

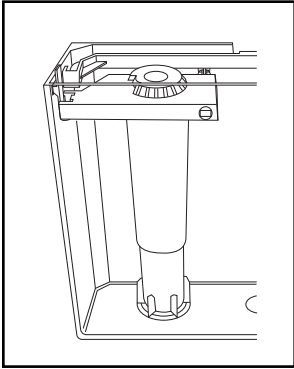

Fig. 12

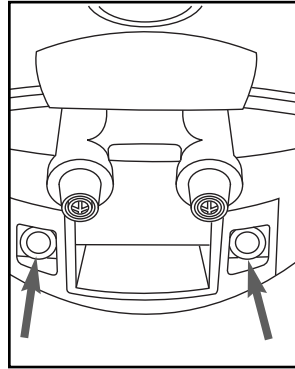

Fig. 13

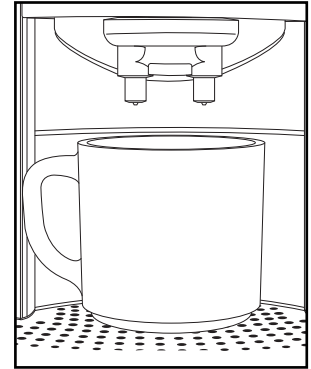
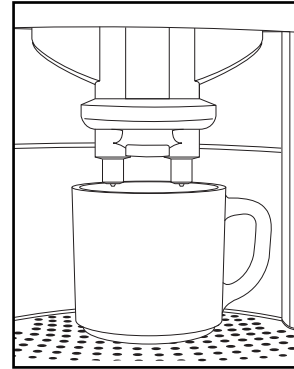

Fig. 14

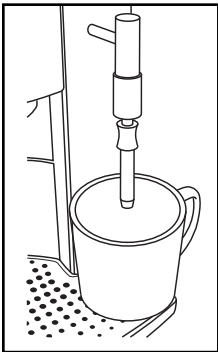
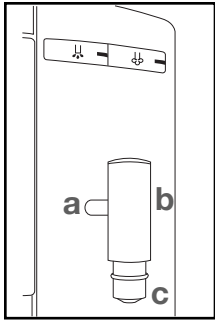

Fig. 15



Fig. 16



a. Metal Tube
b. Chrome Sleeve
c. Steam Nozzle

Fig. 17

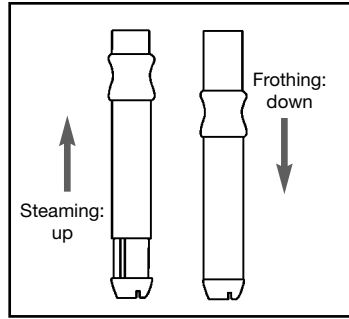

Fig. 18

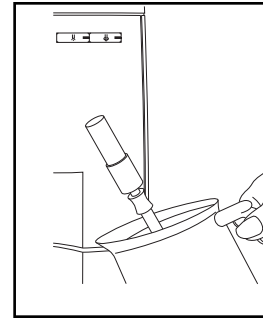

Fig. 19

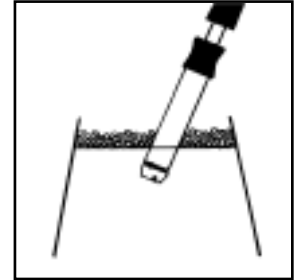

Fig. 20

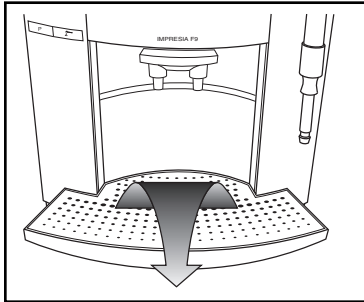

Fig. 21

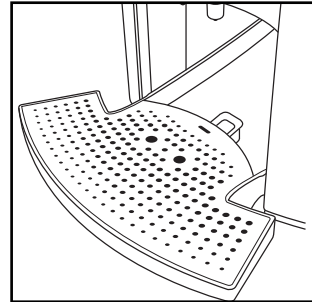

Fig. 22

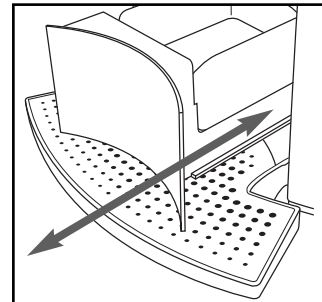

Fig. 23

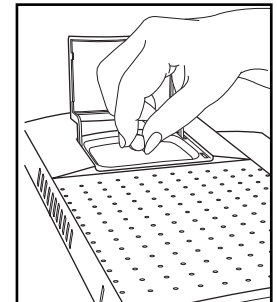

Fig. 24

Table of Contents

	Page		Page
Important Safeguards / Jura-Capresso.....	2	18. PROGRAMMING	17
Illustrations.....	4–7	a. Programming AROMA.....	18
1. Product Registration.....	9	b. Programming Temperature	18
2. Customer Service.....	9	c. Programming Water Quantity (Cup Sizes)	18
3. WELCOME TO THE IMPRESSA F9	9	d. Programming the 1-Cup Button	19
a. A Word about "Crema Coffee".....	10	e. Programming Steam Portion	19
b. Pressure Brewing.....	10	f. Programming Hot Water Portion.....	19
c. Different Coffee Drinks.....	10	g. Setting the Time.....	20
d. Coffee Facts.....	10	h. Setting Auto-On Time	20
4. Please Don't / Please Do	10	i. Setting Auto Shut-Off.....	20
5. Factory Settings	11	j. Setting Language.....	21
6. PREPARING MACHINE FOR THE FIRST TIME	11	k. Looking Up Cup Counter.....	21
7. Adding Coffee Beans	12	19. CARE AND MAINTENANCE	21
8. Adjusting the Grinder	12	a. Fill Water	21
9. DAILY PREPARATION	13	b. Empty Tray / Empty Grounds.....	21
10. Grinding and Brewing.....	13	c. Fill Beans.....	21
a. Selecting Cup Size and Strength.....	13	d. Stones and Beans.....	22
11. Using Pre-Ground Coffee.....	13	e. General Cleaning Instructions.....	22
12. Using Hot Water	14	f. Emptying System Before Transport	22
13. FROTHING, STEAMING, HEATING	14	20. AUTOMATIC CLEANING CYCLES	22
14. Heating and Frothing Milk.....	14	a. Cleaning with Special Tablet.....	22
15. Cleaning the Dual Frother Plus	15	b. Decalcifying Procedure	23
16. CLARIS WATER CARTRIDGE	15	21. Tips for Better Coffee.....	24
a. Installing and Activating the Claris Cartridge	16	22. Supplies.....	24
b. Replacing the Claris Cartridge.....	16	23. LIMITED WARRANTY	24
17. Adjusting the Water Hardness.....	17	24. Troubleshooting	25
		Address Information	27

1. PRODUCT REGISTRATION

Please read the enclosed product registration form now. Fill it out and mail or fax it to us within two weeks after purchasing your machine or register online through our website: www.capresso.com. **Important:** This registration is part of your warranty (chapter 23).

2. CUSTOMER SERVICE

Thank you for choosing this Jura-Capresso product. Please study these operating instructions carefully before using your new machine. We highly recommend viewing the enclosed video. For further information please call our special **TOLL FREE number: 1-800-220-5701, Mon-Fri 9AM – 9PM & Sat 9AM – 5PM Eastern Standard Time**. If you call at any other time please leave a message with your telephone number and when we can call you back. You can also send us a **FAX** at: **201-767-9684** or **EMAIL** us at **contact@capresso.com**

3. WELCOME TO THE IMPRESSA F9

This fully automatic coffee center is completely programmable and extremely user friendly. The Impressa F9 is made of the finest materials and features a unique sensor touch panel. The chrome plated metal front with its heavy duty die-cast coffee spout, the stainless steel grid and the elegant cup illumination make it the center piece of any contemporary kitchen. The Impressa F9 can prepare one or two cups of crema coffee at a time. The two-step pressure brewing system – well known in commercial applications – was adapted and refined by Jura coffee specialists and is the trademark of each Jura-Capresso coffee center. This Pre-Brew Aroma-System (chapter 10) ensures

optimal coffee extraction and will finish every cup with a rich layer of "crema" – proof for perfectly pressure brewed coffee. By touching one of three cup symbols and one of three bean symbols you choose the cup size and the coffee strength you want. Touch the **ST@RT** button and the F9 will grind and brew your personal cup of coffee. The integrated solid steel conical burr grinder grinds beans to the preferred fineness. A separate funnel lets you use pre-ground coffee. All coffee, water and steam functions are programmable to your own personal taste. Make any size cup of coffee between 1 and 16 oz. The Dual Frother Plus* lets you froth and steam milk for delicious cappuccinos and lattes. The frother can be programmed to produce steam up to 60 seconds. Need more steam? Just push the steam button again for another 60 seconds of steam. The stainless steel lined ThermoBlock prevents water from coming in contact with aluminum and allows you to brew coffee immediately after frothing (no purging). The hot water function lets you prepare tea and other beverages in seconds. All important functions such as water level, bean container, used coffee container and water filter are monitored automatically. You can even program the machine to turn itself on and off. You can change the language and can check how many cups of coffee you made. Please watch the enclosed video and study this instruction manual before you use the machine on a daily basis. You will get so much more out of your IMPRESSA F9. Enjoy!

* If you prepare many cappuccinos or lattes at a time we recommend the fast and precise frothXpress PLUS system (separately available). This system replaces the Dual Frother Plus and lets you fill cup after cup with the desired amount of hot milk and milk froth automatically. For details visit our website www.capresso.com and watch the videos about the frothXpress Plus system (Super Automatics, Impressa S9).

3a. A WORD ABOUT "CREMA COFFEE"

According to the majority of coffee experts, grinding, tamping and brewing under high pressure is the ideal extracting process for maximum flavor and aroma. Your Jura-Capresso automatic coffee center will always produce espresso and coffee with a thick, foamy layer called "crema." The crema traps the fine aromatics and the light gaseous flavors that register on the palate. The high pressure and the short brewing time prevent the extraction of bitter oils and release less caffeine than any other brewing methods. You will always make the absolute freshest and most aromatic cup of coffee. This is the reason why many European restaurants and hotels serve fresh pressured brewed coffee only. Experiment with your new machine and prepare yourself the best and most enjoyable cup of coffee!

3b. PRESSURE BREWING

You can make any quantity of coffee from 1 to 16 oz. Please note: in order to create the "crema" on top of your coffee, the machine brews coffee at slightly lower temperatures than a drip coffee maker. Since your coffee is delivered directly into your cup we recommend to enjoy it immediately (see chapter 21).

3c. DIFFERENT COFFEE DRINKS

Here are some guidelines for the most popular coffee drinks:

- *Ristretto*: ½ to 1 oz. of coffee.
 - *Espresso*: 1 to 2 oz. coffee.
 - *Double Shot*: 3 to 4 oz. of coffee.
- Sweeten to taste for the above drinks.
- *Crema Coffee*: 5 to 7½ oz. of coffee
 - *Cappuccino*: Espresso plus 3 to 4 oz. of hot frothed milk.

- *Latte*: Espresso plus 3 to 5 oz. of steamed milk with little or no froth.
- *Café Mocha*: Make Espresso then add chocolate syrup to the milk before frothing/steaming.

Experiment with the size of your milk based drinks. For stronger coffee taste add more coffee, for more milk taste use more frothed milk.

3d. COFFEE FACTS

- **Caffeine** is tasteless. A "strong" coffee or espresso is mostly the result of the amount of coffee in relation to the amount of water. The longer a bean is roasted, the less caffeine it has.
 - **Arabica and Robusta** are two genetically different kinds of beans. "Arabica" beans have more flavor and a little less caffeine than "Robusta" beans which are mostly used in lower priced coffees and instant coffees.
 - **Espresso** is not a bean, it's the way the coffee is roasted and prepared. Typical US espresso roasts result in darker beans with an oily outside. European espresso roasts are medium brown with no or very little oils showing on the outside.
- Please note:** If you use dark, oily beans, see chapters 7 & 8 for special handling.

4. PLEASE, DON'T... (or you void your warranty protection):

- Never fill instant coffee into the grinder or ground coffee funnel; it can damage the functioning of the brewing chamber.
- Never fill sugar coated coffee beans into the bean container.
- Never fill frozen beans into the bean container. If you store

beans in the freezer, let them thaw for 3 to 4 hours before filling them into the bean container.

- Never fill anything other than coffee beans into the bean container (no chocolate, rice, nuts, spices, etc.)
- Never fill anything but fresh, cold clean water into the water container, except when decalcifying (chapter 20b).
- Never use mineral or carbonated water. You can use tap water, spring water, distilled water and reverse osmosis water.
- Never repair or open the machine yourself. All repairs should be performed only by an authorized service center.

PLEASE, DO...

- Fill water tank with fresh, cold water only.
- Remove any foreign particles (small stones) from coffee beans.
- Let frozen beans thaw for 3 to 4 hours before pouring them into the bean container.

All Display Messages Are Shown in GREEN

5. FACTORY SETTINGS

Each machine leaves the factory with the following settings:

Filter: NO

Hardness Level: 2

Aroma: Strong

Temperature: High

Big Cup: 240 ml (8 oz.)

Coffee Cup: 150 ml (5 oz.)

Espresso Cup: 60 ml (2 oz.)

1-Cup: 120 ml (4 oz.)

2-Cup: 240 ml (8 oz.)

Water Portion: 150 ml (5 oz.)

Steam: 60 seconds

Time: not set

Unit On: not set

Auto Off: 2 hours after last use

Language: English

CUP ILLUMINATION (Fig. 13)

The cup illumination adds a dramatic touch to brewing coffee. Providing the machine is plugged in, you can activate the cup illumination for 1 minute by pressing any button.

6. PREPARING THE MACHINE FOR THE FIRST TIME

- Make sure all accessories, literature and any other items are removed from the machine and the water tank.
- Make sure the machine sits on an even, flat surface and the drawer, tray and used coffee container are inserted.
- Plug-in machine.
- Do NOT fill water tank now.

Important: Do not install the Claris Filter cartridge now. It can block the machine.

- Turn the machine on by pressing the ON/OFF button (Fig. 3a). The display shows **WWW.IMPRESSA-F-LINE.COM** then **FILL WATER.**

- Remove water tank, fill with fresh, cold water and replace. The following procedure is only necessary when setting up the machine for the first time and after the procedure "Emptying System Before Transport" (chapter 19f).

FILL SYSTEM WATER PORTION

The red light in the Hot Water Button (Fig. 4a) illuminates.

- Place a cup underneath the frother (Fig. 15) and push the Hot Water Button. **SYSTEM FILLING** The machine will pump some water through the frother and stop automatically.

YOUR MACHINE IS HEATING PRESS MAINT.

- Move the cup underneath the coffee spout (Fig. 14) and press the Rinse Button (Fig. 3b). **MACHINE RINSING.** The machine will pump hot water through the coffee spout and stop automatically: **SELECT PRODUCT.** The display will illuminate the cup and strength selection as shown below:



In this setting the machine is ready to brew coffee.

- Open the bean container lid and fill with some beans (Fig. 6).
- Place an empty cup (at least 8 oz.) under the coffee spouts.
- Touch and hold your finger on the **ST@RT** symbol until the machine starts grinding. Initially, the grinding chamber may not fill properly with ground coffee. The machine will start brewing, then interrupt and the display will show **FILL BEANS.**
- Touch and hold **ST@RT** again. This time the machine will grind and brew and stop by itself. Discard this first cup of coffee. Your next cup will be perfect (chapter 10a explains the use of the sensor touch symbols).

Please note: If coffee only comes out of one spout, move the spout up and down a few times to clear the internal flow. You are now ready to make coffee.

7. ADDING COFFEE BEANS

- Open the bean container lid (Fig. 1.9), fill with beans (Fig. 6).

The container holds approx. 220 grams (8 oz.). Close the lid.

Frozen Beans: Let them thaw for 3 to 4 hours before adding into the bean container. This will prevent moisture from seeping into the grinder.

Sugar Coated Beans: DO NOT fill sugar coated beans into the grinding chamber. The sugars will stick to the burrs and clog the flow of ground coffee. Have your local coffee emporium grind the sugar coated beans for you and use as described in chapter 11.

Using Oily Beans:

Beans with an oily surface tend to stick together. This may prevent a continuous flow of beans from the bean container into the burrs. As a result the grinder does not grind enough coffee and you might get weak or no coffee at all. Stir the beans in the bean container just before grinding. Alternatively, you can also pour the beans in an open bowl and let them sit for about 5 hours. The oils will evaporate (this will not change the taste of your coffee). Then fill the beans into the bean grinder. Now beans will feed into the burrs more easily.

8. ADJUSTING THE GRINDER

You can adjust the grinder to the roast of your coffee.

We recommend the following:

Light roast: use a finer adjustment.

Dark roast: use a coarser adjustment.

- Open the lid of the bean container (Fig. 1.9).
- To adjust grinding turn the selector switch to the desired position (Fig. 7).

The smaller the dots, the finer the grind. The bigger the dots, the coarser the grind.

Important: The grinding grade can only be adjusted while the grinder is actually grinding.

Attention: Oily beans tend to stick together. Stir beans just before grinding to ensure a proper flow of beans into the burrs.

9. DAILY PREPARATION

We recommend filling the water container every morning with fresh, cold water. This will enhance the taste of your coffee.

- Push and hold the On/Off button until the display turns on. After WWW.IMPRESSA-F-LINE.COM the display shows **HELLO YOUR MACHINE IS HEATING**. After approx. two minutes the display shows **PRESS MAINT.** and the red light in the Rinse Button (Fig. 3b) will illuminate.
- Press the Rinse Button. Hot water will warm up all internal parts and pump through the coffee spouts. The water will be caught in the drawer underneath. The rinse cycle stops by itself and the display reads: **SELECT PRODUCT**. The cup and bean symbols illuminate. You are now ready to make coffee.

10. GRINDING AND BREWING

The F9 uses a 2-step brewing process (Pre-Brew Aroma System). This process first moistens the ground coffee (pre-brew phase), stops for a few seconds and then starts the brewing process.

Please note: After the pre-brew phase you can stop the brewing process at any time by simply pushing the 1-Cup button. This will not affect your cup settings.

10a. SELECTING CUP SIZE AND STRENGTH

With the machine in the **SELECT PRODUCT** mode, you can choose five cup settings and three different strength settings.

- Adjust the height of the coffee spout to your cup size (Fig. 14) and place one or two cups underneath the coffee spouts.

Option One: Touch Screen Controls (Fig. 5)

On the touch screen display you can choose from three cup sizes and three strength settings, for total of 9 settings: **BIG CUP, COFFEE, ESPRESSO** each in **MILD, NORMAL** or **STRONG**.

- Touch the symbols and watch how the display changes.
- Once you have selected your preferred combination, just touch and hold **ST@RT** until grinding begins.

Please see chapter 5 for the amount of coffee brewed for each of the symbols. To change these cup sizes see chapter 18c.

Please note: You need to touch **ST@RT** for one second to activate the grinding/brewing process. This delayed action prevents the machine from making coffee if somebody accidentally touches the **ST@RT** symbol.

Option Two: 1-Cup and 2-Cup Buttons

In addition to the nine selections on the touch screen you can also use the 1-Cup and 2-Cup button (Fig. 3c, 3d) to grind and brew coffee.

Please see chapter 5 for the amount of coffee brewed for these buttons. To change these cup sizes see chapter 18d.

Please note: The 2-Cup button will automatically brew twice as much coffee (max. 16oz.) as the 1-Cup button.

11. USING PRE-GROUND COFFEE

You can also use pre-ground coffee, bypassing the grinder. This comes in handy if someone requests decaf, sugar coated or flavored coffee.

- Push the Pre-Ground Coffee Button (Fig. 3f). The display shows: **FILL POWDER SELECT PRODUCT**.
- Open the lid for the ground coffee funnel (Fig. 1.8) and fill the funnel with one or two scoops of ground coffee.

Important: Do NOT fill this funnel with instant coffee and do not use more than two level scoops of coffee.

- Touch one of the three cup symbols to select cup size and then touch **ST@RT**. While brewing, the display shows (for example) **BIG CUP POWDER**.

Please note: When using pre-ground coffee, you cannot use the 1-Cup or 2-Cup button.

Please note: If you push the scoop button accidentally, touch **ST@RT** to clear. The F9 starts the brewing process, and stops after a few seconds. The display will return to **SELECT PRODUCT**.

Please note: After use of sugar coated or flavored coffee through the pre-ground coffee funnel you may experience some flavor transfer when going back to your regular coffee. Push the Rinse Button (Fig. 3b) once or twice to process some water through the coffee spouts.

12. USING HOT WATER

With the Hot Water Button (Fig. 4a) you can make a cup of tea, a quick soup or add hot water to your coffee, making it less strong.

Caution: Always make sure that you have a container underneath the frother (Fig. 15) when using the hot water function, otherwise hot water might splatter, causing severe injuries.

- Push the Hot Water Button **WATER PORTION**. Hot water will flow immediately out of the frother.
- To stop the water flow, push the Hot Water Button again.

Please note: The hot water portion is set to approx. 5 oz. It can be programmed from 1 to 16 oz. (chapter 18f).

13. FROTHING, STEAMING AND HEATING

The steam function can be used to heat up any liquid and to steam and froth milk.

Steaming Position:

The metal cylinder is in the UP position (Fig. 18). In the steaming position hot steam is injected into the milk (or any other liquid) without creating a frothy layer on top.

Frothing Position:

The metal cylinder is in the DOWN position (Fig. 18). In the frothing position hot steam and air is injected into the milk creating warm milk and a firm layer of tiny froth bubbles.

14. HEATING AND FROTHING MILK

- Fill a pitcher (10 to 12 oz. capacity) or a large cup with at least 4 to 5 oz. of cold milk.
- Push the Steam Button (Fig. 4b). The Steam Button's red light will start blinking and the display reads **YOUR MACHINE IS HEATING**. After a few seconds the red light stays illuminated and the display reads **SELECT PRODUCT**.
- Immerse the tip of the frother into the milk and push the Steam Button again (Fig. 4b). Hot steam will be injected into the milk. During this time the display shows **STEAM PORTION**.
- To stop the steam function, push the Steam Button again.

Please note: Steam output will automatically stop after 60 seconds. If you need more steam just push the Steam Button again and you will have another 60 seconds of steam. You can also change the steam output to a shorter interval (chapter 18e).

Tips for frothing (Cappuccino):

Start in the steaming position (cylinder "up") for 10 to 20 seconds. This way your milk will be warmed up first. Then push the cylinder "down". Milk froth will build up. This way the froth on top of your milk is also warm. If the frothed milk is not warm enough, continue in the steaming position.

Steaming and frothing directly in your cappuccino cup:

With practice, you can steam and froth directly in your cappuccino cup. First steam and froth the milk, then add your espresso shot.

Skim milk will produce the most froth and will let you taste more of the coffee. 1% and 2% milk will give you less froth. Regular whole milk (3% fat) will produce the least amount of froth.

15. CLEANING THE DUAL FROTHER PLUS

Always keep the Dual Frother Plus clean and free of milk deposits. Hardened milk particles will make it impossible to create milk froth.

Fast cleaning:

- Immediately after finishing frothing, place a cup underneath the frother (Fig. 15) and push the Hot Water Button (Fig. 4a). Let hot water run through the frother for about 3 seconds. This will flush out any small milk droplets.
- Push the Hot Water Button again to stop.

Thorough cleaning of the Dual Frother parts:

- Remove the Dual Frother (Fig.16) from the Steam Nozzle (Fig. 17c) by pulling down the soft collar of the clip-on connector.
- Unscrew the black tip (Fig.16a) from the Clip-On Connector (Fig.16c). You can use a coin to loosen the black tip.
- Soak all three parts in hot soapy water.

Make sure that the two side holes and the channel of the black tip (Fig. 16a) are free of any milk deposits.

Cleaning the steam nozzle (Fig. 17)

- Place a cup underneath the Steam Nozzle (the Dual Frother is off) and press the Hot Water Button. Let hot water run for a few seconds through the Steam Nozzle.

- Push the Hot Water Button again to stop.

Tip: If the steam nozzle is blocked by hardened milk, use a needle and loosen up the milk deposit. Then let some hot water pass through the Steam Nozzle.

Assembly of Frother Parts

- Make sure the Steam Nozzle (Fig. 17c) is screwed onto the Metal Tube (Fig. 17a) finger tight.
- Assemble the Dual Frother and make sure that the tip is screwed onto the Connector (Fig 16a, c) finger tight.
- Push the black Clip-on Connector (Fig.16c) firmly into the steam nozzle (the connector should sit flush with the chrome sleeve so that the steam nozzle is no longer visible)

Please note: If the parts are not put together tightly it will not be possible to create the frothy foam on top of the milk.

16. CLARIS WATER CARTRIDGE

The machine comes with one Claris water cartridge. The Claris water cartridge is specially made for use with the Impressa machines. The Claris cartridge:

- Reduces the water hardness up to 75%.
- Removes (if present) up to 85% chlorine, up to 90% lead, up to 95% copper and up to 67% aluminum.
- Cleans the water through an upward current principle (Fig. 9) just before the brewing cycle starts, ensuring freshly filtered water every time you make coffee.
- Eliminates decalcifying. When using the Claris water cartridge, you never need to decalcify your machine.
- Is available through your retailer, the enclosed mail order form, or through www.cappresso.com, or call 1-800-220-5701.

16a. INSTALLING & ACTIVATING THE CLARIS WATER CARTRIDGE

Important: Never install the cartridge before or during the first time preparation of the machine.

- Make sure the water tank is empty.
- Remove cartridge from its bag.
- Open water container lid and pull up the holder for the Claris cartridge (Fig.10).
- Insert the cartridge with its tapered end down into the water container. Make sure it fits snugly inside the fins. Push down gently (Fig.11).
- Close the holder for the cartridge so that it engages in the water tank (Fig.12).
- Fill the water tank with fresh cold water and replace.

You must activate the cartridge as follows:

- Push and hold the P button. The display shows <FILTER NO>
- Touch the **ST@RT**; the word **NO** starts blinking.
- Touch either arrow, display shows: **FILTER YES**.
- Touch the **ST@RT** to confirm. The display shows:
INSERT FILTER WATER PORTION
- Place a large container underneath the frother (at least 30 oz. capacity).
- Push the Hot Water Button. The machine pumps water through the frother, activating the filter. This will take about 90 seconds. During this time the display reads **FILTER RINSING**.

When the water flow stops the displays reads

YOUR MACHINE IS HEATING

The machine automatically returns to its coffee brewing setting:

SELECT PRODUCT

Please note: As long as the filter is activated, the water hardness setting is automatically turned off.

16b. REPLACING THE CLARIS CARTRIDGE

The filter is monitored automatically. After approx. 50 liters of water (55 quarts), the filter loses its effect. The display will show: **REPLACE FILTER SELECT PRODUCT**. You can still make coffee, but we recommend replacing the filter within one week!

Attention: The filter should be changed every 2 months if you use less than 50 liters of water. In this case, no message will appear in the display.

Important: Once the filter has lost its calcium suppressing abilities, calcium will build-up inside the machine. Since the Water Hardness Selector is off, the machine will not remind you when to decalcify. This could clog and ruin your machine.

- Remove the old filter. The cartridge is environmentally friendly. Dispose it with your regular household trash.
- Make sure the water tank is empty.
- Remove cartridge from its bag.
- Open water container lid and pull up the holder for the Claris cartridge (Fig.10).
- Insert the cartridge with its tapered end down. Make sure it fits snugly over the white mesh piece inside the water container. Push down gently (Fig.11).
- Close the holder for the cartridge so that it engages in the water tank (Fig.12).
- Fill the water tank with fresh cold water and replace.
- Turn the machine off.
- Push and hold the Rinse Button.

The machine beeps and the display shows:

WATER PORTION INSERT FILTER

- Place a large container underneath the frother (at least 30 oz.)
- Push the Hot Water Button. The machine pumps water through the frother, activating the new filter. This will take about 90 seconds. During this time the display shows:

FILTER RINSING.

When the water flow stops the displays shows:

YOUR MACHINE IS HEATING

The machine automatically returns to the coffee brewing mode:

SELECT PRODUCT

17. ADJUSTING THE WATER HARDNESS

Important: If the Claris Cartridge is activated (see chapter 16a) this chapter does not apply.

The water is heated inside the machine. With use, this leads to calcium deposits forming inside the machine. The display will remind you when it is time to perform a decalcifying cycle. The machine is set to level 2 (medium hard water). If you have harder water you need to set it to a higher level. If you have softer water you can set it to level 1. If you are not sure about the hardness of your water, ask your local water company for the "Water Hardness in Grains."

HARDNESS LEVEL 1: grains 2-9

HARDNESS LEVEL 2: grains 10-19

HARDNESS LEVEL 3: grains 20-29

HARDNESS LEVEL 4: grains 30+

You can also use the enclosed water hardness indicator strip to determine the water hardness:

- Insert the stick for one second into the water you want to use. Shake off any excess water and wait for one minute.
- If all five fields of the test stick turn reddish, set the hardness level to 4. If four fields turn reddish, set the hardness level to 3. If three or less fields turn reddish, leave the level in position 2.

You can change the hardness settings as follows:

SELECT PRODUCT

- Push and hold the P button (Fig. 3e) until you hear a beep. The display will show two red arrows and **FILTER NO.**
- Touch the right hand arrow once and the display shows: **HARDNESS LEVEL 2.**
- Touch **ST@RT** until you hear a beep. The **2** starts blinking.
- Touch the left or right arrow until the desired number appears: **1, 2, 3, 4** or **-**.
- Touch **ST@RT** to confirm. The number stops blinking.
- Push the P button to return to **SELECT PRODUCT**

Important: If you choose the selection "-" the water hardness monitor is turned off. In this case the machine will NOT remind you when it is time to decalcify. Turning off the monitor requires you to use distilled water only or the Claris Filter (chapter 16a). If you use regular or bottled water the machine will build up calcium. If calcium build-up inside the machine is not removed, it can lead to a complete machine break down.

18. PROGRAMMING

Please note: As long as you are in programming mode, you cannot brew coffee.

You can change a variety of functions. To get into programming mode press and hold the P button (Fig. 3e). You will hear a beep

and two red arrows will appear in the touch screen display panel, indicating that you are in programming mode.

The first screen will show:

< **FILTER NO** >

By repeatedly pushing the right arrow > the display shows all the functions you can change or check:

WATER HARDNESS LEVEL 2

AROMA STRONG

TEMP. HIGH

WATER QUANTITY

1 CUP 150 ML

STEAM 60 SEC

WATER PORTION

TIME --:--

UNIT ON --:--

OFF AFT. 2 HRS

SUPPLIED ...

LANGUAGE ENGLISH

Changing the different functions works in the following pattern:

- Push and hold the P button, until the two red arrows show in the display.
- Go to the function you want to program by repeatedly pushing the left of right arrows.
- Touch **ST@RT**
- Change the function to the desired setting using either arrow.
- Confirm the new setting by touching **ST@RT**.
- Push the P button, to leave programming mode.

PROGRAMMING / ACTIVATING CLARIS FILTER

Activating the Claris Cartridge is explained in chapter 16a.

PROGRAMMING WATER HARDNESS

Changing the water hardness level is explained in chapter 17.

18a. PROGRAMMING AROMA

The factory setting is **STRONG**. You can change to **NORMAL**. In **NORMAL** the Impressa F9 will grind a little less coffee in each of the three strength selections (coffee bean symbols).

- Press the P-Button.
- Touch the right arrow symbol repeatedly until the display shows **AROMA STRONG**.
- Touch **ST@RT**.
- Touch the right arrow once: **AROMA NORMAL**.
- Touch **ST@RT** to confirm.
- Press P button to return to **SELECT PRODUCT**.

18b. PROGRAMMING TEMPERATURE

The factory setting is **HIGH**. You can change to **NORMAL**. In **NORMAL** the temperature is approx. 7° F lower than in high.

- Press the P-Button.
- Touch the right arrow until the display shows **TEMP. HIGH**.
- Touch **ST@RT**.
- Touch the right arrow once: **TEMP. NORMAL**.
- Touch **ST@RT** to confirm.
- Press P button to return to **SELECT PRODUCT**.

18c. PROGRAMMING WATER QUANTITY (cup sizes)

Each of the three cup symbols (Fig. 5) in the touch screen display can be set to any size from 30 and 240 ML (milliliters), respectively 1 to 8 oz. (30 ML = 1 oz.). The factory settings for

the three cup symbols are:

BIG CUP: 240 ML (8 oz.)

COFFEE (cup): 150 ML (5 oz.)

ESPRESSO (cup): .. 60 ML (2 oz.)

- Press the P-Button.
- Touch the right arrow until the display shows **WATER QUANTITY**.
- Touch **ST@RT**. The display shows **SELECT PRODUCT** and illuminates the three cup symbols.

Please note: touch all three cup symbols and the display will show you the actual cup size. e.g. BIG CUP 240 ML or ESPRESSO 60 ML.

- Touch the cup symbol for which you want to change the size. e.g. **ESPRESSO 60 ML**.
- Touch **ST@RT**. The number **60** starts blinking.
- Use the right arrow to increase, the left arrow to decrease the size. Push the arrow repeatedly, until the desired cup size is displayed: e.g. **ESPRESSO 45 ML** (= 1 ½ oz.).
- Touch **ST@RT** to confirm. The display shows **WATER QUANTITY**. You can touch another cup symbol to change that size (repeat steps a through d) or press the P Button to return to **SELECT PRODUCT**.

18d. PROGRAMMING THE 1-CUP BUTTON

You can change the cup size for the 1-Cup Button (Fig. 3c). Choose from 30 to 240 ML (= 1 to 8 oz.).

Please note: The 2-Cup Button automatically delivers twice as much coffee.

The factory setting for the 1-Cup Button is 120 ML (4 oz.), for the 2-Cup Button 240 ML (8 oz.).

- Press the P-Button.
- Touch the arrow until the display shows **1 CUP 120 ML**.
- Touch **ST@RT**. The number **120** starts blinking.
- Touch the right or left arrow repeatedly until the desired size is displayed.
- Touch **ST@RT** to confirm. The display lets you now select the strength for the 1-CUP button.
- Touch the bean symbols to choose **MILD, NORMAL** or **STRONG**.
- Touch **ST@RT** to confirm.
- Press the P Button to return to **SELECT PRODUCT**.

18e. PROGRAMMING STEAM PORTION

The steam portion can be programmed between 3 and 60 seconds. The factory setting is **STEAM 60 SEC**.

- Press the P-Button.
- Touch the arrow until the display shows **STEAM 60 SEC**.
- Touch **ST@RT**. The number **60** starts blinking.
- Touch either arrow repeatedly until the desired duration is shown.
- Touch **ST@RT** to confirm.
- Press P button to return to **SELECT PRODUCT**.

Please note: During steaming you can always stop the flow of steam by simply pushing the Steam Button. This will not change the setting. When the steam output stops you can immediately resume steaming by pressing the steam button again.

18f. PROGRAMMING WATER PORTION

The Hot Water Button can be programmed to dispense any amount up to approx. 16 oz. (480 ML). The factory setting is 5 oz. (150 ML).

- Press the P-Button.
- Touch the right arrow until the display shows **WATER PORTION**.
- Place a cup or container underneath the frother (Fig. 15).
- Touch **ST@RT**. The display shows **PRESS KEY** and the red light in the Hot Water Button illuminates.
- Push the Hot Water Button. Hot water will be pumped through the frother into the cup. The display reads **ENOUGH WATER? PRESS KEY**.
- When the desired amount of hot water is dispensed, push the Hot Water Button to stop the flow. The amount of hot water in your cup is now programmed. The display shows **WATER PORTION**.
- Press the P button to return to **SELECT PRODUCT**.

Please note: When pumping hot water through the steam nozzle you can always stop the flow of hot water by simply pushing the Hot Water Button. This will not change the programmed setting. When the hot water output stops, you can dispense more by pressing the Hot Water button again.

18g. SETTING THE TIME

You can enter the actual time into the machine. Once the time is set you can then program the machine to turn on at a specific time (next chapter).

Please note: The time is displayed in the 24 hr mode (not AM/PM). If the actual time is 3:45 pm you must set the time to 15:45.

- Press the P-Button.
- Touch the right arrow until the display shows **TIME --:--** .
- Touch **ST@RT**. The hour segment starts blinking.
- Touch either arrow repeatedly to set the hours.
- Touch **ST@RT** to confirm. The minute segment starts blinking.

- Touch either arrow repeatedly to set the minutes.
- Touch **ST@RT** to confirm. Now the actual time is set.
- Press the P button to return to **SELECT PRODUCT**.

Please note: The Impressa F9 will keep the time as long as the machine is plugged in. If you unplug the machine or if you have power interruption, the time will be lost.

18h. SETTING THE AUTO-ON TIME

You must first set the time (chapter above).

You can set the machine to turn on at a specific time. It will turn on at that time, warm up and the display shows **PRESS MAINT**. Press the Rinse Button and you are ready to brew coffee.

- Press the P-Button.
- Touch the right arrow until the display shows **UNIT ON --:--**.
- Touch **ST@RT**. The hour segment starts blinking.
- Touch either arrow repeatedly to set the hours.
- Touch **ST@RT** to confirm. The minute segment starts blinking.
- Touch either arrow repeatedly to set the minutes.
- Touch **ST@RT** to confirm. Now the Auto Turn On time is set.
- Press the P button to return to **SELECT PRODUCT**.

18i. SETTING THE AUTO SHUT-OFF

Your F9 is programmed to turn off 2 hours after last use. Select from ½ hour to 9 hour shut-off or no automatic shut-off.

- Press the P-Button.
- Touch the right arrow, the display shows **OFF AFT. 2.0 HRS**.
- Touch **ST@RT**.
- Touch either arrow repeatedly until desired setting is displayed.
- Touch **ST@RT** to confirm.

- Press the P button to return to **SELECT PRODUCT**.

Please note: In order for the machine to turn off automatically it must be in the **SELECT PRODUCT** mode. If you leave the machine in programming mode (red arrows showing), or in any other mode, the machine will not turn off automatically.

18j. SETTING LANGUAGE

The F9 is set to ENGLISH. You can change the display to German, French, Italian, Spanish, Portuguese or Dutch.

- Press the P-Button.
- Touch the right arrow until the display shows **LANGUAGE ENGLISH**.
- Touch **ST@RT**.
- Touch either arrow repeatedly to select the desired language.
- Touch **ST@RT** to confirm.
- Press the P button to return to **SELECT PRODUCT**.

18k. CUP COUNTER

The cup counter shows the total number of coffees made.

- Press the P-Button.
- Touch the right arrow until the display shows **SUPPLIED....**
It will show the total number of coffees brewed.
- Touch any of the cup symbols or coffee buttons and the display shows how often this selection has been used.
- Press the P button to return to **SELECT PRODUCT**.

19. CARE AND MAINTENANCE

19a. FILL WATER

When the display shows **FILL WATER**, no more coffee can be made until you fill the water container. The water container will never be completely empty. The low water floatation device

(Fig. 8.4) activates the **FILL WATER** indicator when there are about 10 oz. of water left.

- Remove water tank, rinse and fill with fresh water and replace.

19b. EMPTY TRAY / EMPTY GROUNDS

Used coffee grounds are collected in the used coffee container (Fig. 2.19). If the display shows **EMPTY GROUNDS** or **EMPTY TRAY**, no more coffee can be made until you empty the used coffee container.

- Carefully lift and remove drawer since there is water in it (Fig. 21).
The display shows **TRAY MISSING**.

Important: Do NOT unplug the machine while you are emptying the coffee grounds.

- Empty the used coffee container and the drawer.
- Push the drawer back into the machine (Fig. 22). The display still shows **TRAY MISSING**.
- Place the used coffee container on the tray and insert back into the machine (Fig. 23). The display shows **SELECT PRODUCT** and you may now continue brewing coffee.

19c. FILL BEANS

When the display shows **FILL BEANS**, open the bean container lid and add beans (Fig. 6).

Please note: The message **FILL BEANS** will disappear after making the next cup of coffee.

Attention: If the display shows **FILL BEANS** and there are ample beans in the bean container, stir the beans so they flow into the grinder (chapter 8).

We recommend cleaning the bean container from time to time with a dry cloth before you refill beans (please make sure the machine is turned off when cleaning.)

19d. STONES AND BEANS

Every coffee specialty store will tell you that occasionally stones can be found in with coffee beans. Small stones will be processed through the burr grinder without any harm (the stone will end up in the used coffee container).

However larger stones can block the burr grinder. The noise of the grinder will become very loud and the grinder will block.

Before Filling Beans into the Bean Container:

- Shake your bean bag thoroughly so that a stone will fall to the bottom of the bag.
- Before emptying the bean bag completely, check if there are any particles that look like stones and remove them.

19e. GENERAL CLEANING INSTRUCTIONS

Never use abrasive materials or chemicals to clean the machine.

- Clean the housing with a soft, damp cloth.
- Rinse water tank daily and fill with fresh, cold water.

19f. EMPTYING SYSTEM BEFORE TRANSPORT

This procedure is necessary to prevent water and frost damage in case you intend to transport your Impressa F9.

- Turn machine off.
- Place a cup underneath the frother.
- Push and hold the Steam Button until the display shows: **SYSTEM EMPTYING**. The machine will push a bit of water and steam into the cup underneath the frother. After about 30 seconds it will turn off automatically.

Important: The next time you turn the machine on you must follow the instructions in chapter 6.

Please note: Before transporting the machine, make sure that the water tank is empty, the filter cartridge is removed (discard and use a new cartridge), the bean container is empty, the drawer

and used coffee container are empty and clean.

Secure the lids of the water tank and the bean container with scotch tape. Pack entire machine with thick cushioning material on all sides to prevent damage.

20. AUTOMATIC CLEANING CYCLES

20a. CLEANING WITH SPECIAL TABLET

The machine monitors how many coffees are brewed and how often the rinsing program is activated. After approx. 200 coffees the display will show **CLEAN MACHINE SELECT PRODUCT**.

Please note: You can continue to make coffee, however we highly recommend that you clean the machine as described below within the next few days. This cleaning program will remove oil build-ups in the brewing chamber.

This cleaning program takes about 15 minutes. Please use one white cleaning tablet (enclosed). The machine comes with a pack of 2 tablets. To re-order cleaning tablets see chapter 22.

Important: Once the cleaning program has started do not interrupt the procedure.

- Make sure the machine is on and the water tank is full.
- Push and hold the Rinse button until the display shows **EMPTY TRAY**.
- Remove and empty the drawer and replace complete assembly (Fig. 23).

Important: Even if the drawer is empty, you still need to remove it for approx. 20 seconds and then replace it.

The display shows **PRESS MAINT**.

- Push the Rinse Button (Fig. 3b). The display shows **MACHINE CLEANING**. After a moment the machine beeps and the display shows **TABLET PRESS MAINT..**

- Open the ground coffee lid and drop in one white cleaning tablet (Fig. 24).
- Push the Rinse button. The display shows **MACHINE CLEANING**. The cleaning program will dispense hot water in intervals through the coffee spout into the drawer.
- When finished, the display shows **EMPTY TRAY** and the machine "beeps".
- Lift and remove the drawer. Empty the used coffee container and drawer and replace. The display shows **SELECT PRODUCT** indicating the machine is now ready to brew coffee again.

20b. DECALCIFYING PROCEDURE

The machine has an integrated decalcifying program. When the display shows **MACHINE SCALED SELECT PRODUCT** it is time to decalcify the machine. You can still make coffee however, it is highly recommended that you decalcify the machine within the next 3 to 4 days.

Please note: If you use the Claris water cartridge and the display shows **MACHINE SCALED SELECT PRODUCT**, then your cartridge function is not activated. Follow the instructions in chapter 16a to program the Claris Cartridge function.

Important: The decalcifying program must not be interrupted.

DECALCIFYING AGENT: Only use our special decalcifying tablets. For supplies see chapter 22.

CAUTION: Never use vinegar or any other decalcifying agent. This might damage internal parts of the machine.

1. Turn off machine and let cool down for at least one hour.
Empty Water tank.

2. With the machine off, push and hold the Rinse Button (Fig. 3b) until the display shows **EMPTY TRAY**.
3. Remove and empty the drawer and replace complete assembly (Fig. 23).

Important: Even if the drawer is empty, you still need to remove it for approx. 20 seconds and then replace it. The display shows **AGENT IN TANK PRESS MAINT.**

4. Dissolve three of the large, square tablets in 16 oz. of water and pour this mixture into the water tank.
Please note: Do not use more than 16 oz. of water.
5. Replace water tank.
6. Place a container (at least 16 oz.) underneath the frother. The displays still shows **AGENT IN TANK PRESS MAINT.**
7. Push the Rinse Button. The machine will pump the mixture through the frother in intervals. Then it pumps the mixture (internally) into the drawer. During this procedure the display shows **MACHINE DESCALED**. When this cycle is finished the machine beeps and the display shows **EMPTY TRAY**.
8. Remove the container from underneath the frother. Carefully lift and remove the drawer, empty and thoroughly rinse all parts and replace. The display shows **FILL WATER**.
9. Remove the water tank, rinse thoroughly, fill with cold fresh water (approx. 16 oz.) and replace.
10. Place a container (at least 16 oz.) underneath the frother. The display shows **PRESS MAINT. FILL WATER**.
11. Push the Rinse Button. First the machine will pump hot water in intervals through the frother to remove any decalcifying mixture. During this procedure the display shows **MACHINE DESCALED**. When the cleaning cycle is finished the machine beeps and the display shows

EMPTY TRAY.

12. Remove the container from underneath the frother. Remove the drawer, empty, rinse thoroughly and replace. The display shows **PRESS MAINT.**
13. Push the Rinse Button. The machine will run a regular rinse cycle, **MACHINE RINSING** and then the display will return to its normal position **SELECT PRODUCT.**
14. Clean the chrome front and the grid with a moist, soft cloth.

21. TIPS FOR BETTER COFFEE

Pre-warm your cups

A warm cup will keep the coffee hot longer. Hold your cup underneath the frother and push the Hot Water Button (Fig. 4a) for a few seconds. Discard the water into the drawer.

Move the coffee spout close to the cup

This way the coffee will lose less aroma.

Sugar and cream

Cold milk reduces the temperature of your coffee. If you like your coffee "with cream" or with "cream and sugar", add it to the cup first and steam it for a few seconds. Then add the coffee.

Extremely hot coffee

If you like your coffee extremely hot, the Impressa F9 can accommodate you. Brew your coffee, but reduce the cup size by approx. ½ oz., e.g. if you plan to brew a 6 oz. cup, change the cup size in programming to 5 ½ oz. (165 ML). After brewing your coffee, push the Steam Button (Fig. 4b) and wait until the light stops blinking. Move the cylinder of the frother up for steaming (Fig. 18). Now immerse the tip of the frother into your cup. Push the Steam Button again and inject steam for about 10 to 20 seconds. Your coffee will be extremely hot.

24.

Please note: Some of the aroma of the coffee will be lost in this process.

22. SUPPLIES

The following supplies are necessary to keep your machine in good working order:

- Claris Water Filter Cartridge (eliminates the need for decalcifying tablets).
- Special Cleaning Tablets (white tablets).
- Decalcifying tablets (large, white square tablets).

Please note: You must use decalcifying tablets if you do not use the Claris cartridge.

All supplies are available through:

- the enclosed mail order form that came with your machine
- our toll free line at 1-800-220-5701 or
- the Internet at www.cappresso.com.

23. LIMITED WARRANTY

Please note: This warranty will be void if the Warranty / Product Registration has not been received two weeks after the purchase date (you can fax or mail the registration or you can register through our website www.cappresso.com)

This limited warranty covers your new IMPRESSA F9 for household use only (commercial use voids warranty): **One Year or 4,000 coffee brewings, whichever comes first.**

This warranty is in effect for the period and usage described above from the date of the first purchase and is limited to the United States of America. This warranty covers all defects in materials or workmanship (parts and labor) including free UPS

ground transportation for both ways within the continental United States. For Hawaii and Alaska freight is not covered by this warranty.

TRANSPORT: When sending the machine, use the original packing materials, the inner and outer cartons or use approximately 2" of bubblewrap and insert machine in a carton which will hold 40lbs. Any damage in transit is NOT covered by this warranty.

This warranty does not cover:

- Any machine NOT distributed by JURA-CAPRESSO within the United States.
- Any machine not purchased from an Authorized Dealer.
- Damage caused by accident, abuse, negligence, misuse, improper operation or failure to follow instructions contained in this manual.
- Any service or alteration performed by an unauthorized person, company or association.
- Damage caused by neglecting and omitting maintenance, cleaning and decalcifying cycles.
- Damage caused by use of instant coffee or any other ingredients not allowed in this product.

Other limitations and exclusions:

Any implied warranties including fitness for use and merchantability are limited in duration to the period of the express warranty set forth above and no person is authorized to assume for JURA-CAPRESSO any other liability in connection with the sale of the machine. JURA-CAPRESSO expressly disclaims liability for incidental and consequential damages caused by the machine. The terms "incidental damages" refer to the loss of the original purchasers time, loss of the use of the machine or other costs relating to the care and custody of the machine. The terms

"consequential damages" refer to the cost of repairing or replacing other property which is damaged when this machine does not work properly. Any loss of income is excluded. The remedies provided under this warranty are exclusive and in lieu of all others. This warranty gives you specific legal rights, and you may also have other rights which vary from state to state.

24. TROUBLESHOOTING

A. NO COFFEE COMES OUT OF THE COFFEE SPOUT

Reason: Beans in bean container are not feeding properly into the grinder because they are stuck together.

Solution: Stir beans before grinding and while grinding turn the grinding selector to the coarsest setting.

When using very oily beans pour the beans onto a plate and let some of the sticky oils evaporate (this will not harm the aroma of the coffee).

Reason: You used ground coffee in the ground coffee funnel. The ground coffee was too fine.

Solution: Use ground coffee which is ground somewhat coarser.

Reason: No water is transported through the system.

Solution: Remove water container and make sure that the connecting valve is free of any particles (like a coffee bean etc).

Reason: The ground coffee funnel is clogged; the internal brewing chamber is clogged.

Solution: Place a large cup underneath the coffee spout. Push the rinse button (Fig. 3b) a few times until the blocked coffee is removed. (Never fill more than 2 scoops of coffee in the ground coffee funnel; the funnel is not a storage area for ground coffee). Also, use a ground coffee which is ground somewhat coarser.

B. THE DISPLAY READS "FILL WATER" BUT THERE IS ENOUGH WATER IN THE WATER TANK.

Reason: The low water floatation device (Fig.8.4) is missing.

Solution: Within the water tank is a small compartment (like a mouse trap). Inside is a small black floatation device. On top is a small clear see-through plastic cover. This small plastic cover is missing and the floatation device is outside of the small compartment. Check if you can locate both pieces and put it back together. If you cannot find them, call 1-800-220-5701. We will send the pieces to you **FREE OF CHARGE**.

C. INSUFFICIENT FROTHED MILK PRODUCTION

Reason: Milk is initially not cold enough or your milk is not suited for thick frothing.

Solution: Make sure milk is cold. Use a different type of milk. Skim milk will produce the thickest and longest lasting froth. Full fat milk will produce less thick froth.

Reason: The components of the frother are not assembled properly, or the components are clogged with hardened milk, or one or more of the components is missing, or the steam nozzle is clogged.

Solution:

- a. Remove frother. Check that steam comes out of the steam nozzle. If not, use a needle and clear blockage from inside steam nozzle.
- b. Clean all other frother parts and assemble properly. See chapter 15.
- c. If any parts are missing call Customer Service: 1-800-220-5701 or use the enclosed mail order form to order the missing part.

D. GRINDER MAKES AN EXTREMELY LOUD NOISE; NO BEANS ARE GROUND

Reason: A stone is blocking the burr grinder.

Solution: Call customer service: 1-800-220-5701.

E. THE DRAWER (Fig. 21) DOESN'T PULL OUT

Solution: Turn off the machine. Wait a minute. Turn machine on and wait until it stops making any noise. Now try to pull out the drawer. If this does not work, try the above procedure again. If you are still unable to remove the drawer call customer service: 1-800-220-5701.



Jura-Capresso LLC.

81 Ruckman Road

Closter, NJ 07624

1-800-220-5701 • 201-767-3999

Fax: 201-767-9684

email: contact@capresso.com

Website: www.capresso.com