



IMPRESSA E40

IMPRESSA E60

IMPRESSA E65

Instructions for use



IMPRESSA

Jura Impressa E40/E60/E65

English..... 6 – 19

 = Note

 = Important

 = Tip

Jura Elektroapparate AG, CH-4626 Niederbuchsiten,
Internet <http://www.juraworld.com>



Fig. 1



Fig. 2



Fig. 3



Fig. 4

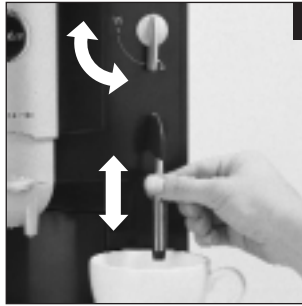

Fig. 5

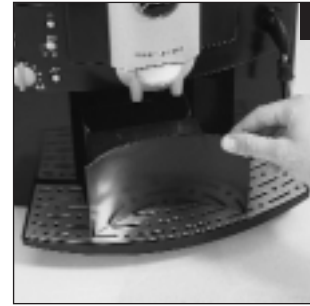

Fig. 6

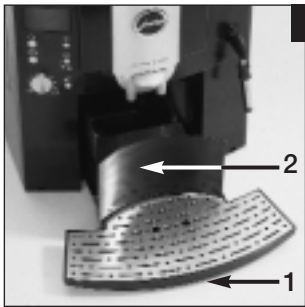

Fig. 7

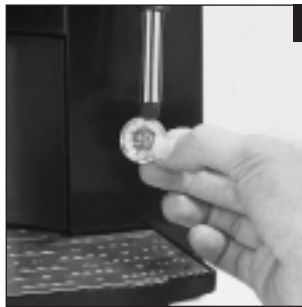
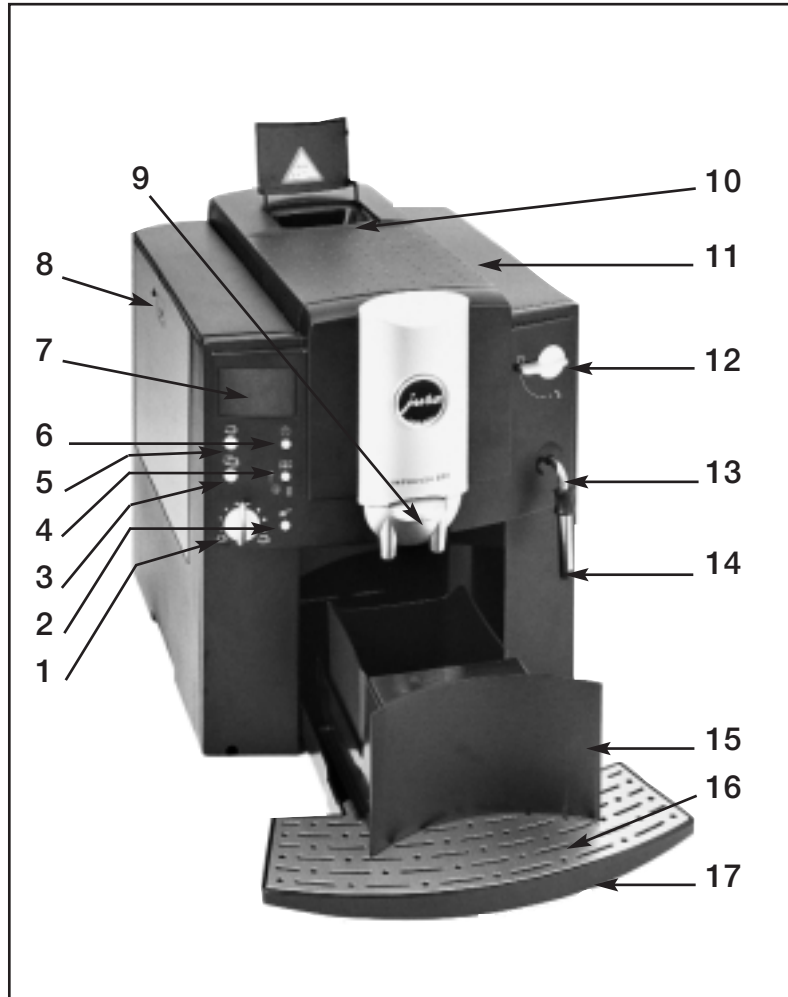

Fig. 8



Fig. 9

Operating elements Jura Impressa E40/E60/E65



- 1 Water quantity switch
- 2 Powder coffee selection switch
- 3 Coffee key for 2 cups
- 4 Maintenance key (for functions such as: rinsing, cleaning, de-scaling, filter)
- 5 Coffee key for 1 cup
- 6 ON/OFF switch
- 7 Display with symbols
- 8 Water tank with carrying handle
- 9 Height-adjustable coffee spout
- 10 Pre-ground coffee filler funnel
- 11 Cover for beam container
- 12 Selector switch for hot water/steam
- 13 Pivoting nozzle for hot water/steam
- 14 Frothing aid
- 15 Container for coffee grounds
- 16 Drip tray cover
- 17 Drip tray

Contents

Jura Impressa E40/E60/E65

1. Description	page 6	10. Switching machine off.....	page 11
1.1 The symbols mean	page 6	11. Care and maintenance	page 12
2. Safety instructions.....	page 7	11.1 Fill water	page 12
2.1 Warnings	page 7	11.2 Empty grounds container	page 12
2.2 Safety precautions.....	page 7	11.3 No drip tray.....	page 12
3. Preparation of the machine	page 7	11.4 Clean unit	page 12
3.1 Checking the mains voltage	page 7	11.5 Unit scaled	page 12
3.2 Checking the fuse	page 7	11.6 Use of Claris filter cartridges	page 12
3.3 Filling the water tank.....	page 7	11.7 Insert filter.....	page 12
3.4 Adding coffee beans	page 7	11.8 Replace filter	page 13
3.5 Adjusting the grinder	page 8	11.9 General cleaning instructions.....	page 13
3.6 Adjusting the water hardness	page 8	11.10 Regular service.....	page 13
3.7 Adjustable automatic switch-off.....	page 9	11.11 Empty system	page 14
4. First start of operation	page 9	12. Cleaning.....	page 14
4.1 Fill system with water	page 9	13. Decalcifying.....	page 15
5. Rinsing the machine.....	page 10	14. Disposal	page 16
6. Adjusting the water quantity	page 10	15. Tips for perfect coffee.....	page 16
7. Drawing off espresso/normal coffee	page 10	16. Messages.....	page 17
7.1 Drawing off espresso/strong coffee.....	page 10	17. Problems.....	page 18
7.2 Drawing off espresso/extra coffee.....	page 10	18. Legal information	page 19
7.3 Drawing off powder coffee.....	page 10	19. Technical data.....	page 19
8. Drawing off steam	page 11		
8.1 Return to stand-by	page 11		
9. Drawing off hot water	page 11		

Important information for the user

Thank you for choosing this Jura product.

Please study these instructions carefully before using your new machine for the first time and keep them in a safe place for easy reference in future.

Should you require further information or should particular problems occur that are not dealt with in sufficient detail for you in these operating instructions, please contact your local dealer or us for the information you require.

1. Description

This fully automatic espresso/coffee machine impresses because of its compactness and can prepare 1 or 2 cups of excellent, professional-quality espresso/coffee with guaranteed froth. The unique Jura pre-brew system (Intelligent Pre Brew Aroma System I.P.B.A.S[®]) ensures full use of the coffee aroma. The machine works fully automatically at the push of a button. With the coffee aroma, you have the choice between normal, strong and extra strong, depending on taste. The integrated grinder grinds the beans to the required fineness. A separate filler funnel makes it possible to use additional, pre-ground sorts of coffee. The water quantity can be set individually. Electronic filling controls for the water tank and container for coffee grounds simplify operation. Thanks to the integrated rinsing, cleaning and de-scaling programmes, care and maintenance are also quick and easy.

1.1 The symbols mean

- 1 COFFEE READY
- 2 COFFEE POWDER
- 3 RINSE MACHINE
- 4 STEAM / HOT WATER
- 5 CLOSE TAP
- 6 FILL WATER
- 7 EMPTY GROUNDS CONTAINER / DRIP TRAY MISSING
- 8 CLEAN MACHINE
- 9 MACHINE SCALED
- 10 REPLACE FILTER
- 11 OPEN TAP

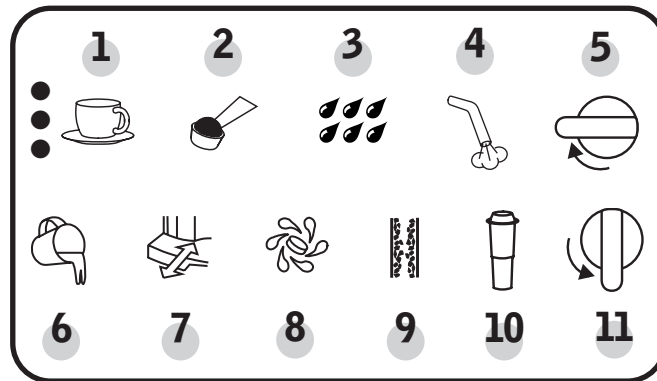

2. Safety instructions

2.1 Warnings

- Children are unaware of the dangers that electrical machines can represent; for this reason, children should never be left unsupervised with electrical machines.
- This machine should only be used by people who have read these instructions.
- Never use a faulty machine or one with a damaged power cable.
- Never immerse the machine in water.

2.2 Safety precautions

- Never subject the machine to the effects of the weather (rain, snow, frost) and never operate it with wet hands.
- Place your machine on a solid level surface. Never leave it on a surface which is warm or hot (hob etc.). Choose a location which is inaccessible for children or for pets.
- Always pull the plug out if you are away for a long time (holidays etc.).
- Always pull the plug out first before cleaning.
- When pulling the plug out, never tug on the cord or on the machine itself.
- Never repair or open the machine yourself. All repairs should be done by authorised service centres only using original Jura spare parts and accessories.
- The machine is connected to the mains power socket via an electric cable. Make sure that nobody trips over it and pulls the machine down. Keep children and pets well away from the machine.
- Never put the machine or even parts of it into the dishwasher.
- Choose a place with a good circulation of air in order to prevent the machine from overheating.

- If you use de-scaling agents containing acid, remove any splashes and drips on sensitive surfaces, in particular natural stone and timber surfaces and/or take corresponding precautionary measures.

3. Preparation of the machine

3.1 Checking the mains voltage

The machine is set to the correct voltage before leaving our factory. Ensure that your mains voltage corresponds to the details quoted on the rating plate attached to the bottom of the machine.

3.2 Checking the fuse

The machine is designed for a current of 10 Amps. Check that the fuse used matches this.

3.3 Filling the water tank

- Remove the water tank and rinse it out well with cold tap water.
- Then fill the water tank and put it back into the machine. Ensure that the tank engages properly (Fig. 1).



Only use fresh, cold water. Never fill with milk, mineral water or other fluids. You can also add water without removing the tank. Simply lift the lid up and pour in water from above with a vessel. Close the lid again.

3.4 Adding coffee beans

- Lift up the cover of the bean container (11).
- Clean out any dirt or foreign objects from the bean container.
- Pour coffee beans into the bean container and close the cover again.

3.5 Adjusting the grinder

You have the possibility of adjusting the grinder to the roast of your coffee. We recommend the following:

- for a light roast → a finer adjustment
- for a dark roast → a coarser adjustment

- Open the cover of the bean container.
- To adjust the grinding, turn the selector switch (Fig. 2) to the required position.
- You have the following possibilities:
 - the smaller the dots, the finer the grinding
 - the larger the dots, the coarser the grinding

 the degree of grinding should only be adjusted with the grinder in operation.

3.6 Adjusting the water hardness

Water is heated inside the machine. This leads to calcium deposits (scale) during use. This is automatically displayed. Before you use your machine for the first time, you must adjust it to the hardness of the local water. For this purpose, please use the enclosed test sticks.

 1° German water hardness corresponds to 1.79° French water hardness.

The machine has 6 hardness settings to choose from. During the setting, the water hardness selected is shown on the display.

Level for Claris Filter

Setting for the use of the Claris filter cartridge.



Level 0 = water hardness is switched off

The automatic scale display is switched off.



Level 1

German water hardness 1 – 7°
French water hardness 1.79 – 12.53°



Level 2

German water hardness 8 – 15°
French water hardness 14.32 – 26.85°

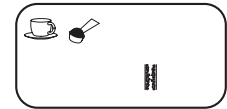

Level 3

German water hardness 16 – 23°
French water hardness 28.64 – 41.14°







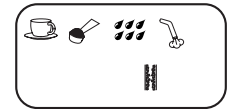



Level 4

German water hardness 24 – 30°
French water hardness 42.96 – 53.7°



The machine is adjusted to **hardness level 3** in the factory. You can alter this setting by proceeding as follows:

- Pull the plug and the feed wire out of the wire box on the back of the machine.
- Put the plug in.
- Do **not** switch the machine on.
- Press the  draw-off key for about 3 seconds. Now, the , , ,  symbols light up.
- Now select the corresponding level with the  draw-off key and press the ON/OFF  switch in order to save the setting. The symbols go off.

 The water hardness only need to be set before the first use of the machine or if a different water quality is used. If you do not carry out a change of level for longer than 30 seconds, the display goes off. The last figure you have stored remains valid.



3.7 Adjustable automatic switch-off

You can amend the automatic switch-off time of 1 1/2 hours set by Jura. The machine offers you three levels for this:

1st level

The  symbol lights up. The automatic switch-off is not activated.







2nd level

The , ,  symbols light up. The automatic switch-off is set to 1 1/2 hours.

3rd level

The , , , , ,  symbols light up. The automatic switch-off is set to 3 1/2 hours.







In order to set or alter the automatic switch-off time, please proceed as follows:

- Connect the plug with the mains.
- However, do **not** switch the machine on.
- Please the  draw-off key for about 3 seconds. The , ,  symbols light up.
- Select the required level with the  draw-off key.
- Press the ON/OFF  switch in order to save the required level.

 If you do not carry out a change of level for longer than 30 seconds, the display goes off. The last figure you have stored remains valid.

4. First start of operation

4.1 Fill system with water

- Switch your machine on with the ON/OFF  switch.
- The  symbol lights up.
- Place an empty cup under the pivoting nozzle for hot water/steam (13).
- Switch the selector switch for hot water/steam (12) to the  position. The machine now lets off water and the  symbol flashes at the same time.
- If the  symbol lights up on the display, turn the selector switch for hot water/steam (12) back to the  position.

5. Rinsing the machine

When the  symbol lights up, a rinsing process is demanded.



- Place an empty cup under the coffee-spout.
- Press the rinsing maintenance key (4). The rinsing process is automatically ended.

 If the machine has been switched off and has already cooled down, the rinsing function will be demanded when the machine is switched on.
A rinsing is automatically started when the machine is switched off.

6. Adjusting the water quantity

The water quantity can be infinitely adjusted with rotary knob (1). The small key means little water for espresso, the large cup means a lot of water for coffee.

 You can also change the water volume while coffee is being drawn off. Simply turn the rotary knob (1) to give more or less water.

 With draw-off key , the machine automatically doubles the water quantity and distributes it to 2 cups.



7. Drawing off espresso/normal coffee

- As soon as the  symbol lights up, you can draw off coffee.
- Place 1 or 2 cups, as necessary, under coffee-spout (9) and press the required draw-off key. The pre-brew system (I.P.B.A.S.®) moistens the coffee powder, briefly interrupts the flow and then starts the actual brewing process.

 You can interrupt the draw-off prematurely by pressing any of the coffee draw-off keys.



 In order to obtain outstanding froth, you can adapt the coffee-spout (5) individually to the size of your cups (Fig. 3).

7.1 Drawing off espresso/strong coffee

- Place 1 cup under the coffee-spout (9).
- Press the  draw-off symbol until two dots light up to the left of the  symbol.



 This draw-off of espresso / strong coffee is only possible for 1 cup.

7.2 Drawing off espresso/extra coffee



- Place 1 cup under the coffee-spout (9) .
- Press the  draw-off symbol until three dots light up to the left of the  symbol.

 This draw-off of espresso / extra coffee is only possible for 1 cup.

7.3 Drawing off powder coffee

- Press the  selector switch. The  and  symbols light up.
- Now put 1 or 2 level measuring spoons of pre-ground coffee into the filler funnel for pre-ground coffee (10).
- Place 1 or 2 cups under the coffee-spout (9) and press the required coffee key.





 Never use water-soluble instant coffee or quick coffee. We recommend that you only use powder from freshly ground coffee beans or pre-ground, vacuum-packed coffee. **Never put more than 2 portions of coffee in. The filler funnel is not a storage container.**

 If the  draw-off key is pressed by mistake, the selection can be cancelled by pressing the  draw-off key. Your machine rinses.

 After drawing off powder coffee, we recommend that you regularly clean the filler funnel with a clean bottle-cleaning brush.

8. Drawing off steam





The steam can be used for heating liquids and also for frothing milk for cappuccino. Make sure that the frothing aid (14) is pushed upwards when heating liquids. When frothing liquids, push the frothing aid downwards (Fig. 5).

- Place a cup under the pivoting nozzle for hot water/steam (13).
- Immerse the frothing aid (14) into the milk to be frothed or the liquid to be heated and turn the selector switch for hot water/steam (12) to the  position.
- Immediately after this, press the maintenance key (4).
- When you have reached the required quantity of steam, turn the selector switch for hot water/steam (12) back to the position .
- The ,  symbols light up.
- If you would like to draw off a coffee immediately after the steam, please proceed as described in point 8.1.

 The max. draw-off time is about 8 minutes. A little water will come out first when frothing. It can be let off before actually drawing off steam. The good result, e.g. when frothing milk, is not influenced in any way.



 At the start of a steam draw-off, there can be splashes. The pivoting nozzle for hot water/steam gets hot. Please avoid direct contact with the skin.

8.1 Return to stand-by

- Place a vessel under the pivoting nozzle for hot water/steam (13).
- Press a draw-off key, the  symbol lights up on the display.
- Turn the selector switch for hot water/steam (12) to the position .
- Draw water off until the flow of water is automatically interrupted and the  symbol lights up.
- After this, turn the selector switch for hot water/steam (12) back to the  position.

 After each steam draw-off, clean the pivoting nozzle with a damp cloth.

9. Drawing off hot water

- Place a cup under the pivoting nozzle for hot water/steam (13) and turn the selector switch for hot water/steam (12) to the symbol .
- The machine now produces hot water.
- To finish the process, turn the selector switch for hot water/steam (12) back to the  position.

 At the start of a water draw-off, there can be splashes. The pivoting nozzle for hot water/steam gets hot. Please avoid direct contact with the skin.

10. Switching machine off

When the machine is switched off, the rinsing programme is automatically started. Therefore, place an empty container under the coffee-spout and press the ON/OFF  switch. When the rinsing water has run into the cup, the machine switches off. Throw the rinsing water away.

11. Care and maintenance

11.1 Fill water

- When the  display lights up, no drawing-off is possible. Fill with water as described under point 3.3.

11.2 Empty grounds container

The grounds container collects the coffee grounds. When this display  lights up, no drawing-off is possible and the grounds container must be emptied.

- Push the coffee spout (9) up.
- Remove the drip tray. Be careful, as there is water in it.
- Empty and clean the drip tray and the grounds container (Fig. 6). Push the drip tray and then the grounds container back in (Fig. 7).



 The drip tray must also be emptied when you empty the grounds.

11.3 No drip tray



If the  symbol flashes, the drip tray has not been inserted properly.

 If the drip tray has not been put into the machine, you can clean the interior of the machine. Wipe out any coffee powder that might be in the machine with a damp cloth. Put the drip tray back in again.

11.4 Clean unit

After 200 draw-offs or 160 rinses, the machine must be cleaned; the  symbol flashing announces this. You can continue to draw off coffee or hot water/steam. We recommend carrying out the cleaning (as described in point 12) within the next few days. Warning lamp  does not go out until the complete cleaning process has been carried out.

11.5 Unit scaled











Scale is caused by using the machine and depends upon the hardness level of your water. The machine recognises the necessity of de-scaling. Here too, the flashing  symbol tells you when de-scaling is necessary. You can continue to draw off coffee or hot water/steam. We recommend carrying out the de-scaling (as described in point 13) within the next few days. Warning lamp  does not go out until the complete decalcifying process has been carried out.

11.6 Use of Claris filter cartridges

If the Claris filter cartridges are used correctly, your machine no longer needs de-scaling. You can obtain more information from the brochure “Claris. Hard on scale. Gentle to your coffee machine.” (enclosed in the welcome pack).

11.7 Insert filter

- Pull up the cartridge holder in the water tank. Pressing gently, put the filter cartridge into the water tank (Fig. 4).
- Close the cartridge holder until it engages audibly.
- Fill the water tank with cold fresh tap water and put it back into the machine.



- Switch the machine on with the ON/OFF  switch.
- Press the  draw-off key for about 3 seconds. The degree of hardness set appears on the display.
- Press the  draw-off key until only the  symbol is still alight.
- Press the ON/OFF  switch as a confirmation. The ,  symbols light up.
- Place a sufficiently large vessel under the pivoting nozzle for hot water/steam (13) and turn the selector switch for hot water/steam (12) to the position .
- Draw off water until the  symbol lights up.
- Now turn the selector switch for hot water/steam (12) back to the position .
- When the  symbol lights up, press the maintenance key (4). Your machine rinses and is ready for drawing off coffee.





 The water can be slightly discoloured (not dangerous to health)

11.8 Replace filter

After 50 litres have been drawn off, the filter loses its effect. The  symbol flashes to inform you.

 If you do not draw off often, you should replace the filter cartridge every 2 months, but no report appears on the display. There is a special disk on the cartridge holder so that you can set the replacement date.

- Switch your machine off with the ON/OFF  switch.
- Press the maintenance key (4) for about 3 seconds. The ,  symbols light up.

- Place a sufficiently large vessel under the pivoting nozzle for hot/water steam (13) and turn the selector switch for hot water/steam (12) to the position . The  symbol flashes.
- Draw off water until the  symbol lights up.
- Now turn the selector switch for hot water/steam (12) back to the position .
- When the  symbol lights up, press the maintenance key (4). Your machine rinses and is ready for drawing off coffee.

11.9 General cleaning instructions

- Never use abrasive articles or corrosive chemicals to clean your machine.
- Wipe down the casing on the inside and out using a soft, damp cloth.
- Clean the pivoting nozzle for hot water/steam after each use.
- After heating milk, draw off a little hot water in order to clean the inside of the pivoting nozzle.
- You can take off the frothing aid for a thorough cleaning (Fig. 8).
- The water tank should be rinsed out and filled with clean water every day.









 If there is scale visible in the water tank, you can remove it with a customary de-scaling agent. Remove the water tank from the machine for this purpose.

11.10 Regular service

Regular inspections by Jura Service extend the service life and reliability. Keep the original packaging as transport protection.

11.11 Empty system

! This procedure is necessary in order to protect the machine from damage by frost in transport.

- Switch the machine **OFF** with the ON/OFF  switch.
- Place a vessel under the pivoting nozzle for hot water/steam (13).
- Turn the selector switch for hot water/steam (12) to position .
- Switch your machine back **on** again with the ON/OFF  switch. The  symbol lights up.
- Press the maintenance key  until the symbol  flashes. .
- Draw steam off until the flow of steam is automatically interrupted and the  symbol lights up on the display.
- After this, turn the selector switch for hot water/steam (12) back to the  position.

12. Cleaning







The machine has an integrated cleaning programme.

➔ If the machine needs cleaning, the  symbol flashes. You can continue to draw off coffee or hot water/steam and run the cleaning programme later.







Only use Jura cleaning tablets. They are available from your Jura dealer.

! You must not interrupt the cleaning programme once it has started.







- Switch your machine on with the ON/OFF  key.

- Press the maintenance key (4) for about 3 seconds. The  (only when necessary), ,  symbols light up.
- Fill the water tank.
- Empty the drip tray and the grounds container and put both of them back in again. The  (only when necessary),  symbols go off and the  symbol appears.
- Place a vessel under the coffee spout (9) and press the maintenance key (4). The  symbol goes off.

The  symbol lights up to inform you that the cleaning process has been activated.

- If the  symbol lights up, empty the drip tray (if necessary) and put it back in again. The  symbol goes off and the , ,  symbols light up.
- Now put a Jura cleaning tablet into the filler funnel for powder coffee (10) (Fig. 9).
- Press the maintenance key (4). The ,  symbols go off.

The cleaning process is continued. This is displayed by the  symbol lighting up.



- If the  symbol lights up again, empty the drip tray (if necessary), wait for about 10 seconds before putting it back in again. The  symbol goes off and the ,  symbols light up.
- Place a vessel under the coffee spout (9) again and press the maintenance key (4).
- The cleaning process is continued. This is displayed by the  symbol lighting up. As soon as it has been completed, the  symbol lights up.

- Empty the drip tray and the grounds container and put both of them back in. The ☕ symbol lights up.







 After each cleaning operation the filler funnel for the 2nd coffee type should be cleaned.







13. Descalcing



The machine has an integrated de-scaling programme. If you use a Claris filter cartridge, your machine does not need de-scaling. Only use Jura cleaning tablets. They are available from your Jura dealer.



 If the machine needs de-scaling, the  symbol flashes. You can continue to draw off coffee and hot water/steam and then run the de-scaling programme later.

 Only run the de-scaling programme when the machine has been switched off for at least 2 hours and has cooled down well. The de-scaling programme is started with the machine switched off. Once it has started, the de-scaling programme must not be interrupted.

- Switch your machine off with the ON/OFF  switch and leave it to cool down for 2 hours.
- Remove the water tank and empty it.
- Press the maintenance key (4) for about 3 seconds. The ,  symbols light up.
- Empty the drip tray and the grounds container and put both of them back in again. The  symbol goes off and the ,  symbols light up.
- Completely dissolve the contents of one blister (2 tablets) in 0.5 litres of water in a vessel and pour the mixture into the water tank. Put the tank back in again. The  symbol appear.

- Turn the selector switch for hot water/steam (12) to the position . The  symbol go off and the , , ,  symbols light up.
- Place a sufficiently large vessel under the pivoting nozzle for hot water/steam (13) and press the maintenance key (4).



The lighting of the  symbol and the flashing of the  symbol show you that the de-scaling process has been activated.



- If the  symbol lights up, empty the drip tray (if necessary) and put it back in again. The  symbol lights up.
- Turn the selector switch for hot water/steam (12) back to the position .



The de-scaling process is continued de-scaling solution is guided into the drip tray in the interior of the machine.

- The , ,  symbols light up.

 Rinse the water tank out well and fill it with cold fresh tap water. Then put it back into the machine again. Place a sufficiently large vessel under the pivoting nozzle.

- Empty the drip tray and put it back in again. The ,  symbols light up.
- Turn the selector switch for hot water/steam (12) to position .
- Place a sufficiently large vessel under the pivoting nozzle for hot water/steam (13) and press the maintenance key (4).



The lighting of the  symbol and flashing of the  symbol show you that the de-scaling process has been activated.

- If the , ,  symbols light up, empty the drip tray (if necessary) and put it back in again.



- Turn the selector switch for hot water/steam (12) back to the position .

The de-scaling process is continued and the water is guided into the drip tray in the interior of the machine.

- If the  symbol lights up, empty the drip tray and put it back in again. The  symbol appear.
- After this, press the maintenance key (4). Your machine rinses and is now ready for the next draw-off of coffee.

14. Disposal

For correct disposal, you should return your coffee machine to your dealer, your Jura service centre or the firm of Jura.

15. Tips for perfect coffee

Height-adjustable coffee-spout

You can adjust the coffee-spout to the size of your cups

Grinding

See point 3.5







Pre-warming cups





You can pre-warm the cups with hot water or steam. The smaller the amount of coffee, the more important the pre-warming.

Sugar and cream

Heat is lost by stirring the contents. Adding milk or cream from the fridge considerably lowers the temperature of the coffee.

16. Messages

Display	Cause	Action
	<ul style="list-style-type: none"> – System empty – System too hot after drawing off steam 	<ul style="list-style-type: none"> – Fill system (see point 4.1) – Reset to coffee stand-by
	<ul style="list-style-type: none"> – Wrong position of selector switch 	<ul style="list-style-type: none"> – Put selector switch into correct position
	<ul style="list-style-type: none"> – General troubles 	<ol style="list-style-type: none"> – Switch off <ul style="list-style-type: none"> – disconnect from mains – connect to mains – switch machine on Have machine examined by Jura service centre
	<ul style="list-style-type: none"> – Machine needs rinsing 	Rinsing the machine
	<ul style="list-style-type: none"> – The tank is empty – Floater defective 	<ul style="list-style-type: none"> – Fill with water – Rinse out or de-scale water tank
	<ul style="list-style-type: none"> – Grounds container full – Tray replaced too early after emptying 	<ul style="list-style-type: none"> – Empty grounds container – Only replace the tray after about 10 sec.

Display	Cause	Action
	– Drip tray not inserted properly or missing	– Insert correctly
	– Cleaning necessary	– Carry out cleaning process
	– De-scaling necessary	– Carry out de-scaling process
	– Replacing of filter	– Run program

17. Problems

Problem	Cause	Action
Coffee flow is stopped after pre-brewing	– bean container empty	– Fill with beans
	– not enough coffee powder	– Correct amount of powder
Grinder is very noisy	– foreign body in grinder	– Drawing off coffee with pre-ground powder is still possible
		– Have machine examined by Jura service centre

Problem	Cause	Action
Not enough froth when frothing milk	– milk not suitable	– use full-cream milk
	– frothing aid blocked	– clean frothing aid
	– frothing aid in wrong position	– draw off steam (see point 8)

If the above mentioned messages and/or problems still exist, please contact your dealer or get in touch directly with Jura Elektroapparate AG.

18. Legal information

These operating instructions contain the information necessary for the correct use, operation and maintenance of the machine.

Understanding of and complying with the directions contained in these operating instructions are essential for use of the machine without risk and for safety in operation and maintenance.

The operation instructions cannot cover every imaginable example of use. The machine has been designed for use in private households.

We would further like to point out that the contents of these operating instructions in no way constitute a part or, nor do they alter any previous or existing contract, assurance or legal relationship. All obligations on the part of Jura Elektroapparate AG result from the purchase contract in question, which also contains full details of the only warranty regulations applying to this machine. These contractual warranty terms are neither extended nor limited by the information given in these operating instructions.

The operating instructions contain information protected by copyright. Photocopying or translating into another language shall not be admissible without prior written approval by Jura Elektroapparate AG.

19. Technical data

Voltage:	230V AC
Output:	1350 W
Fuse:	10 A
Safety check:	
Energy consumption standby:	approx. 4Wh
Energy consumption ready to make coffee:	approx. 17Wh
Pump pressure:	max. 15 bar
Water tank:	1,9 litres
Capacity, bean container:	200 gr.
Capacity, grounds container:	max. 16 port.
Cable length:	1,1 m
Weight:	8,3 kg
Dimensions (B x H x D):	28 x 34,5 x 41,5 cm

