

BRAUN

ProGlide-jet

PV 2202

PV 2205

PV 2210

PV 2212

Type 4692

Steam iron

[English](#)

[Use Instructions](#)

[Guarantee](#)

[Service Centers](#)

English

Ceramic sole plate

Your Braun steam iron has a unique, new sole plate made out of a special gliding ceramic material. This process engineered by Braun makes the sole plate extremely easy gliding. Thanks to its properties you will save time during the ironing process.

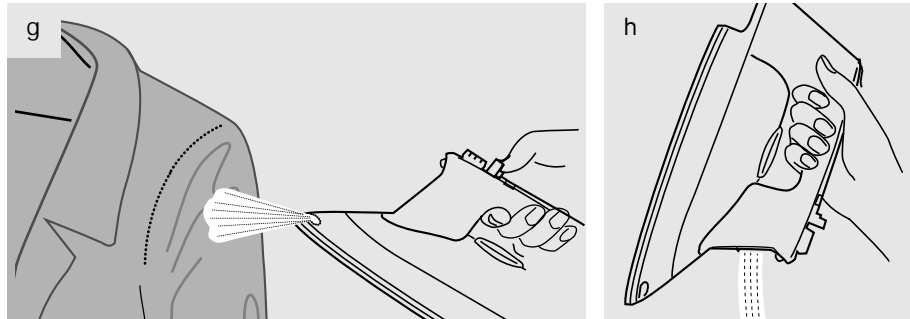
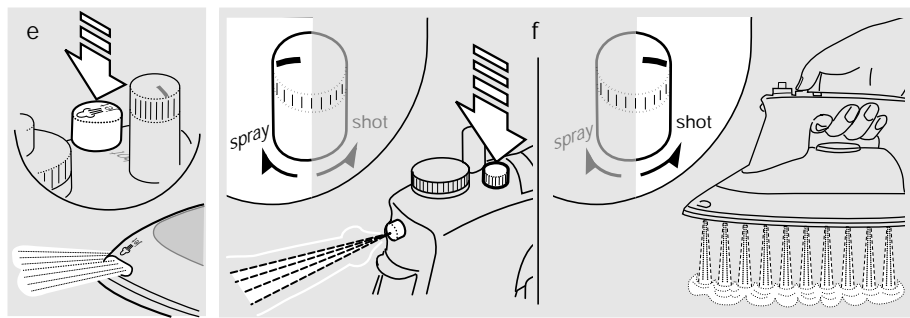
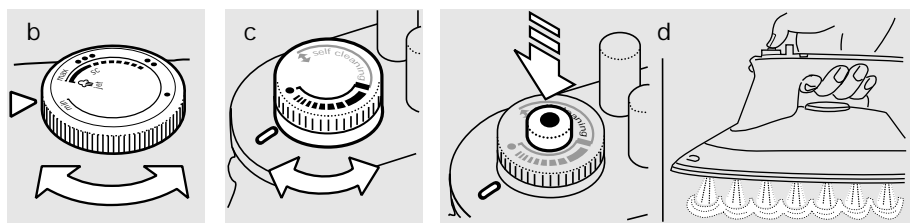
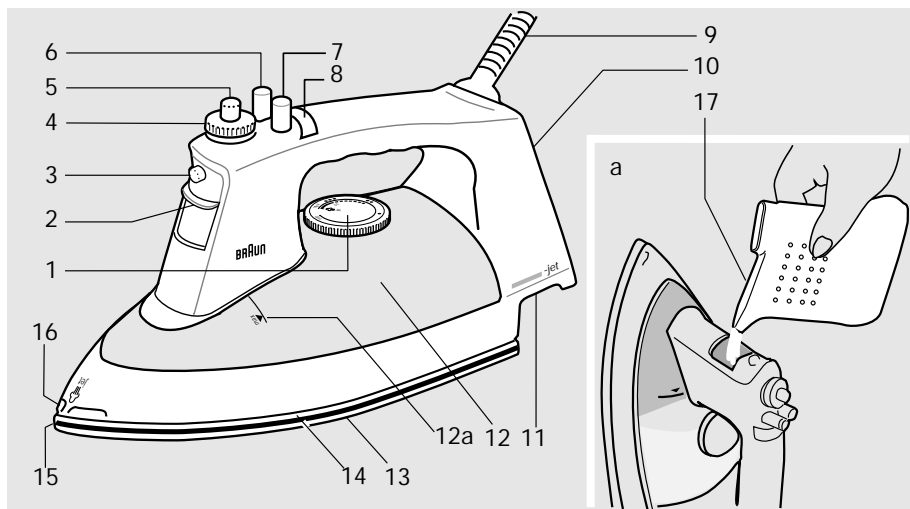

Our products are engineered to meet the highest standards of quality, functionality and design. We hope you thoroughly enjoy your new Braun steam iron.

Important Safeguards

- **Read all instructions carefully before using the iron. Keep the use instructions during the entire life of the iron.**
- Before filling with water, always disconnect the plug from the socket first.
- Always pull the plug and not the cord.
- Electric irons reach high temperatures during operation that could lead to burns.
- Keep the iron away from children, and when it is turned on, keep the unit under supervision.
- Disconnect the plug when leaving the room where you are ironing, even if it is only briefly.
- Never iron or dampen clothes while wearing them.
- During ironing pauses, always place the iron upright in its heel rest.
- Never immerse the iron in water or other liquids.
- The cord should never come into contact with hot objects or the sole plate.
- Check the cord periodically for possible damage.
- Do not use a damaged iron.
- Take it to a Braun Service Center for repair.
- Braun electric appliances meet applicable safety standards.
- This appliance can only be opened by an authorised Braun Service Centre for repairs.
- The cord of this appliance may only be replaced by an authorised Braun Service Centre since special tools are required.
- Faulty, unqualified repair work may cause accidents or injury to the user.
- Make sure your voltage corresponds to that printed on the iron. Connect the iron to an alternating current (~) outlet only.

Table of features for each model

Feature:	Model:	PV 2202	PV 2205	PV 2210	PV 2212
Jet of steam		●	●	●	●
Shot of steam				●	●
Extra steam			●		●
Spray		●	●	●	●

Specifications

Voltage/wattage: See typeplate at the bottom of the unit.

Water tank capacity: 215 cc (approximately 1 filling beaker ⑰ of water filled up to the mark = 1 tank filling).

Description

- ① Temperature selector
- ② Water tank with sliding shutter opening
- ③ Water spray nozzle
- ④ Steam regulator / self-cleaning activator and anti-calc. valve
- ⑤ Extra steam button

- ⑥ Jet of steam button
- ⑦ 1- or 2-function button (water-spray/shot of steam, see «Table of features»)
- ⑧ Pilot light
- ⑨ Pivoting cord
- ⑩ Heel rest
- ⑪ Cord storage/typeplate
- ⑫ Transparent water tank
- ⑬ Maximum marking («max.»)
- ⑭ Sole plate with 71 steam vents
- ⑮ Full-length button groove
- ⑯ Slim pointed tip
- ⑰ Jet of steam outlet
- ⑱ Filling beaker

Praktical Guidelines

Type of Water to be Used

This iron is designed for tap water. However, if you have hard water we recommend to use a mixture of 1/2 part tap water and 1/2 part distilled water from drug stores or grocery stores.

Important: Never use distilled water (battery water). Do not add any additives (e. g. starch) to the water.

To fill iron

1. Pull the plug out of the wall outlet.
2. Put the steam regulator ④ in position «●» (= steam off).
3. Open sliding shutter ②.
4. Place the iron in the upright position and fill with water slowly through the tank opening ② to the «max.» marking ⑩ (a), using the beaker ⑰.
5. Close sliding shutter.

Selecting the temperature

Connect the iron to a safely located wall outlet and select the ironing temperature with the temperature selector ① (b). As soon as the pilot light ⑧ goes out, the iron has reached the temperature selected. To avoid water dripping, always rest the iron upright while heating it up keep the steam regulator ④ in position «●» (= steam off) (c).

You will usually find the following symbols in your garments:



The temperature selector ① is marked with these symbols:

- min. The iron is connected
- Synthetics (acrylic, acetate)
- Silk/rayon/nylon/polyester/cotton blends/wool
- Cotton/linen
- max. Linen

Select the temperature you need according to these symbols.

Spray, shot of steam, jet of steam

Before you start ironing, we recommend to press the buttons 3 or 4 times, in order to activate these functions.

Dry ironing

Set the steam regulator ④ in position «●» (= steam off) (c) for dry ironing. The water spray ⑦ may be used at any temperature setting to dampen the laundry. The jet of steam ⑥ and the shot of steam ⑦ buttons can be activated during dry ironing, provided that the temperature selector ① is within the continuous red area ⑰.

Steam ironing

(see «Table of features»)

Temperature selection: Set the temperature selector ① within the red range steam (b) and wait until the iron has reached the selected temperature (i. e. the pilot light ⑧ goes off). Steam ironing is possible in the entire red range. Steam ironing at lower temperatures may cause water drops instead of steam. Should this happen, turn the steam regulator ④ to the position «●» (= steam off) (c).

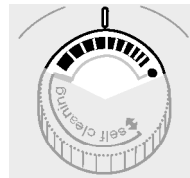

Steam regulator ④: Select the quantity of steam required (c) for each garment with the steam regulator ④. You can increase the quantity by turning the steam regulator clockwise (wide markings) to the end of the red marking.

Caution: While ironing do not turn the steam regulator further, otherwise hot water may come out from the sole plate (see section «Decalcifying/Self-cleaning»).

By turning the steam regulator anti-clockwise you can reduce the quantity of steam or turn the steam off «●» (= steam off) (see «Ironing Guide»).

Constant steam: Your braun steam iron ist equipped with a special tank configuration to provide constant steam even when the water level in the tank is low.

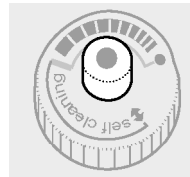

Extra steam* (coming from the steam vents in the sole plate): For stubborn creases and wrinkles, collars and cuffs. When ironing within the red range

area the extra steam function can be used. You can press the button ⑤ (d) for 3 seconds at intervals of no less than 15 seconds.

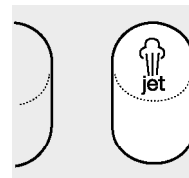

Jet of steam* (coming from the outlets ⑯ at the slim pointed tip ⑮): Caution: Keep children away from the jet of steam and do not hold your fingers in front of the outlets ⑯.

when activating this function.

When ironing within the red range area the jet of steam function ⑥ can be used (e). To do so, press the button ⑥ at intervals of no less than 5 seconds. The jet of steam has been designed not only for steaming hard to reach areas like pleats, inside of pockets etc., but also for steaming hanging clothing (e. g. velvet skirts, curtains, etc.) (g). The jet of steam functions between horizontal and upright positions. Be careful not to touch sensitive textiles with the hot sole plate.

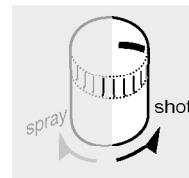

Shot of steam* (coming from the vents in the sole plate): When ironing within the red area the shot of steam function can be used. It gives an extra,

particularly powerful shot of steam penetrating deep into the textiles in order to straighten creases, collars and pleats. The function «shot of steam» can be used in normal ironing and also horizontally for steaming hanging clothing (e. g. velvet skirts, curtains etc.) (g). Press the shot of steam button ⑦ at intervals of no less than 5 seconds. When steaming be careful not to touch sensitive textiles with the hot sole plate.

* If pressed too frequently, it can drip. Should this happen, wait a few seconds before using it again.

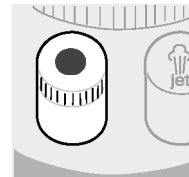

Spray (coming from the nozzle ③): The spray function can be used at any temperature, to dampen laundry. To do so, press the button ⑦ (water spray = blue).

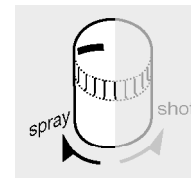

Spray / shot of steam 2-function button: With the models 2210 and 2212 the functions «water spray» and «shot of steam» can be activated with a 2-function button. The desired function can be selected by turning the button ⑦ as far as it will go. The marking (blue = water spray or red = shot of steam) must point to the respective function (f). Turn the button from blue (spray) to red (shot of steam) anti-clockwise and from red to blue clockwise (f).

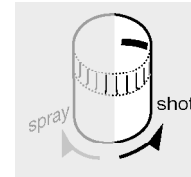

Storage

After ironing, always pull the plug out of the wall outlet. Set the temperature selector ① to «min.» (b) and the steam regulator ④ to «●» (= steam off) (c).

To empty the iron hold it with the open water tank opening ② downwards (h) and shake it 1 or 2 times. The pivoting cord ⑨ conveniently winds up around the cord storage ⑩.

IMPORTANT: Store the cool steam iron in a dry place and always standing on its heel rest ⑩. The sole plate may be damaged by remaining water if it is stored horizontally. The warranty does not cover faults or damage resulting from improper storage of the iron.

Maintenance and Cleaning

To remove residues of minerals/starch from the sole plate always use steel wool. Never use a scouring pad, vinegar or other chemicals. The steam vents ⑬ and jet of steam outlets ⑯ may be cleaned manually with a toothpick, if necessary. Clean the sole plate regularly if you use starch or other aids on the clothes for ironing.

Decalcifying / Self-cleaning

Braun ProGlide-jet irons have a built-in system (anti-calc. valve) to prevent calcification. It allows you to clean residues from the steam chamber. Do not use commercial decalcifiers; they may damage the sole plate. We recommend to use the self-cleaning function every 3 months.

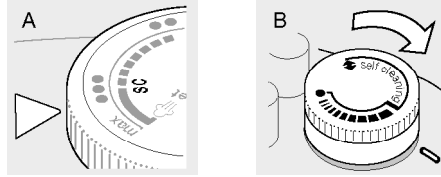

1. Turn the steam regulator ④ to the position «●» (= steam off).
2. Fill the water tank to the marking «max.» ⑫ and turn the temperature selector ① to the ●●● marking («self-cleaning» = SC) (A).
3. Plug the iron into the socket and wait till the pilot light ⑧ goes off.
4. Unplug the iron and hold it over a sink.

5. Turn the steam regulator ④ clockwise to the end of the red marking (B) and then
6. keep turning it to the double-arrow marking ⇄. The steam regulator will lift (C).

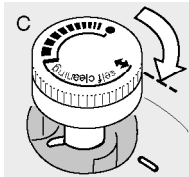

7. Pull out the steam regulator together with the valve vertically (D). Do not touch the lower end of the anti-calc. valve with your fingers, to avoid a possible greasy film.

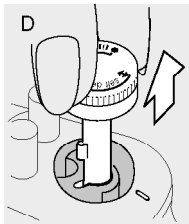

8. Allow all water to drain through the steam vents in the sole plate, while shaking the iron slightly. (Caution: Hot water and steam come out from the sole plate.)
9. Wait for the sole plate to cool down and then clean it (see «Maintenance and Cleaning»).
10. Make sure that the sole plate is completely dry before storing it.

Cleaning the anti-calc. valve on the steam regulator

During the time the sole plate is cooling down we recommend to decalcify the anti-calc. valve in the following way:

1. Put a small quantity of white vinegar (not vinegar essence) or lemon juice into a glass or bowl.
2. Immerse just the bottom part of the valve in the liquid, wait till it is decalcified and carefully brush of remaining residue (E). Do not use a metal brush.
3. Then, rinse it under running water without touching the lower end of the valve.

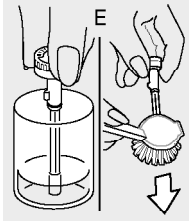

Re-inserting the steam regulator with anti-calc. valve

1. Re-insert the steam regulator so that the double-arrow ⇄ aligns with the marking on the iron (F).
2. Then push it down carefully and at the same time turn the button anti-clockwise.
3. Keep turning the button to the marking «●» (= steam off).
4. If your iron has the shot of steam, refill the tank with water, heat the iron up and press the button ⑦ 3 to 4 times in the shot of steam function before ironing, to rinse the iron.

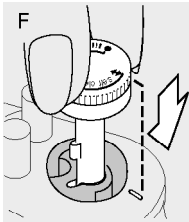

ATTENTION: The iron must not be used without the steam regulator and the anti-calc. valve.

Ironing Guide

To begin ironing, it is best to start with fabrics requiring a lower temperature (e. g. synthetics), and continue with those requiring a higher temperature (e. g. cotton, linen). Silk and silk-like synthetics tend to waterspot, therefore before using the water spray feature, test it on an inconspicuous spot first.

Fabrics	Temperature regulator setting	Steam regulator setting
Synthetics (acrylic, acetate)	●	● (= steam off)
Silk, rayon, nylon, polyester, cotton blends	●●	● (= steam off) to max.
Wool	●●	● (= steam off) to max.
Cotton	●●●	● (= steam off) to max.
Linen	●●● to max.	● (= steam off) to max.

Mixed fabrics: Always select the temperature suited for the most sensitive fibre the garment contains. Follow manufacturer's instructions on the label.

Subject to change without notice.

This product conforms to the EMC-Requirements as laid down by the Council Directive 89/336/EEC.



Guarantee

We grant a 1 year guarantee on the product commencing on the date of purchase.

Within the guarantee period we will eliminate, free of charge, any defects in the appliance resulting from faults in material or workmanship either by repairing, or exchanging parts or exchanging the whole appliance as we may choose.

Not covered by this guarantee: damage arising from improper use or storage (operation with incorrect current/voltage, plugging it into an unsuitable power point, breakage use of commercial decalcifiers, wet storage on the ironing surface), normal wear and defects which have a negligible effect on the value or operation of the appliance.

The guarantee becomes void if repairs are undertaken by unauthorised persons and if original Braun parts are not used.

The guarantee only comes into force if the date of purchase is confirmed by the dealer's stamp and signature on the guarantee card and registration card.

This guarantee extends to every country where this appliance is supplied by Braun or its appointed distributor and where no import restrictions or other legal regulations hinder or prevent service being given under guarantee.

Service under the guarantee does not affect the expiry date of the guarantee. The guarantee on parts or entire appliances which are exchanged ends when the guarantee on this appliance expires.

In the event of a claim under this guarantee, hand in the complete appliance with the valid guarantee card to your dealer, or send both to the nearest Braun Customer Service Centre.

All other claims including for damages resulting from this guarantee are excluded unless our liability is legally mandatory.

Those claims arising out of the sales contract with the vendor are not affected by this guarantee.

For UK only:

This guarantee in no way affects your rights under statutory law.

