

ATTENTION!!
WHEN YOU SEE A "⚠ WARNING!" BE SURE TO HEED THE MESSAGE!
THE INFORMATION CONTAINED IN THESE MESSAGES
CAN SAVE YOUR LIFE!!

MODEL NUMBER	PRODUCT NAME	# OF PERSONS	CARRYING CAPACITY (USER AND EQUIPMENT)
CR3801-S	THE WARRIOR	One (1)	300 lbs / 136 kg
CR3811-S	THE WARRIOR DX	One (1)	300 lbs / 136 kg
CR3806-S	NEXTGEN STEALTH™	One (1)	300 lbs / 136 kg
CR3813-S	NEXTGEN STEALTH™ DX	One (1)	300 lbs / 136 kg
CR3901-S	THE ULTRA-VIEW™ DX	One (1)	300 lbs / 136 kg
CR4055-S	THE TITAN™ XT	One (1)	300 lbs / 136 kg
CR4105-S	THE SKYBOX™ DELUXE	One (1)	300 lbs / 136 kg
CR4106-S	THE LEGEND™	One (1)	300 lbs / 136 kg
CR4200-S	THE EXECUTIVE™	One (1)	300 lbs / 136 kg
CR4250-S	THE ARCH RIVAL™	One (1)	300 lbs / 136 kg
CR4301-S	THE MAXIM	One (1)	300 lbs / 136 kg
CR4500-S	THE INFINITY™	One (1)	300 lbs / 136 kg
CR4601-S	THE SKY-RISE™	Two (2)	500 lbs / 227kg
CR4801-S	THE BIG BUDDY®	Two (2)	500 lbs / 227kg
CR4850-S	THE GUARDIAN	Two (2)	500 lbs / 227kg
CR5005-S	THE PARTNER® PRO	Two (2)	500 lbs / 227kg
CR5020-S	THE PARTNER® PLUS SELECT	Two (2)	500 lbs / 227kg

⚠ WARNING! These products carry strict weight restrictions. DO NOT use these product(s) if you exceed these total weight limitations. Please note that these weight limitations include the user and their equipment. Failure to follow these instructions may result in serious injury or death!

A safe treestand hunting video has been included. Please view it in its entirety prior to using this product!

Thank you for your purchase of this quality Big Game® Treestands product. To ensure your personal safety, please take a moment to carefully read this instruction manual in its entirety before attempting to set-up, install and/or otherwise use this Big Game® Treestands product. Failure to follow these instructions may result in serious injury or death!

Should you have any questions about the installation and/or use of this product, or any other Big Game® Treestands product(s) do not hesitate to call one of our customer service representatives toll free at (800) 268-5077 or visit us online at www.BigGameTreestands.com. Our customer service representatives will answer any questions you may have about any of the complete line of Big Game® Treestands products.

Do not return this product to the retailer if you have any damaged or missing parts. Call Big Game® Treestands for replacement of any damaged or missing parts toll free at (800) 268-5077.

This Instruction Manual complies with the Treestand Manufacturers Association's
TMS 04-Standard Practice for Treestand Instructions & TMS 02-Standard Test Method for Treestand Fall Arrest Systems

LADDERSTAND USAGE INSTRUCTIONS & WARNINGS

ATTENTION!!
WHEN YOU SEE A "⚠ WARNING!" BE SURE TO HEED THE MESSAGE!
THE INFORMATION CONTAINED IN THESE MESSAGES
CAN SAVE YOUR LIFE!!

PLEASE NOTE THAT WARNING! statements have been placed throughout this Instruction Manual. These statements point out important safety information and instructions, which, if not followed could endanger the personal safety and/or property of the operator. It is imperative that the operator of this product, or any other product(s) read and follow all the instructions and warnings contained in this Manual prior to attempting to use this product(s), or any other product(s). Failure to comply with these instructions and/or warnings may result in serious personal injury or death!

⚠ WARNING! Failure to read and strictly comply with the instructions contained in this Instruction Manual may result in serious injury or death!

⚠ WARNING! FALLS FROM A TREESTAND CAN OCCUR ANYTIME AFTER LEAVING THE GROUND. THESE FALLS COULD RESULT IN EITHER SERIOUS INJURY OR DEATH! FOR YOUR PERSONAL SAFETY, PLEASE TAKE A MOMENT TO CAREFULLY READ THIS PRODUCT INSTRUCTION MANUAL IN ITS ENTIRETY BEFORE ATTEMPTING TO ASSEMBLE, SET-UP, INSTALL AND/OR OTHERWISE USE THIS BIG GAME® PRODUCT. AT LEAST ANNUALLY, REVIEW THE CONTENTS OF THIS INSTRUCTION MANUAL AND WATCH THE SAFE TREESTAND HUNTING DVD. ADDITIONALLY, KEEP THESE INSTRUCTIONS FOR THE ENTIRE DURATION THAT YOU OWN THIS PRODUCT(S). FAILURE TO FOLLOW THESE INSTRUCTIONS MAY RESULT IN SERIOUS INJURY OR DEATH!

⚠ WARNING! A "Treestand Safety: It's Up To You" DVD has been included with this treestand. Please view it in its entirety prior to using this or any other Big Game® product(s). Failure to follow these instructions may result in serious injury or death!

⚠ WARNING! THE SAFE USE AND OPERATION OF THIS PRODUCT IS THE SOLE RESPONSIBILITY OF THE USER. IT IS ALSO THE SOLE RESPONSIBILITY OF THE OWNER TO PROVIDE ANY PERSON(S) WHO BORROW OR PURCHASE THIS PRODUCT WITH THESE INSTRUCTIONS AND THE AFORE MENTIONED *TREESTAND SAFETY: IT'S UP TO YOU* DVD. FAILURE TO FOLLOW THESE INSTRUCTIONS MAY RESULT IN SERIOUS INJURY OR DEATH! ADDITIONALLY, FAILURE TO FOLLOW THIS INSTRUCTION MAY SUBJECT YOU TO PERSONAL LIABILITY PENALTIES AS DETERMINED BY THE U.S. JUDICIAL SYSTEM.

⚠ WARNING! Prior to each hunt, you must inform someone of your hunting location, including the specific location of your treestand and the expected duration of your hunt. Failure to follow these instructions may result in serious injury or death!

⚠ WARNING! Prior to each hunt, make sure that you have a signaling device (e.g., mobile phone, radio, whistle, signal flare or Personal Locator Device (PLD)) in your possession and in an operable condition. This device must be within easy access should you experience the need to contact emergency assistance. Failure to follow these instructions may result in serious injury or death!

This Instruction Manual complies with the Treestand Manufacturers Association's
TMS 04-Standard Practice for Treestand Instructions & TMS 02-Standard Test Method for Treestand Fall Arrest Systems

READ THIS MANUAL IN ITS ENTIRETY PRIOR TO USING THIS PRODUCT.

ATTENTION!!
WHEN YOU SEE A "⚠ WARNING!" BE SURE TO HEED THE MESSAGE!
THE INFORMATION CONTAINED IN THESE MESSAGES
CAN SAVE YOUR LIFE!!

- ⚠ WARNING!** Do not remove, modify, and/or omit any portion or otherwise mechanically modify this Big Game® product(s) or its assemblies in any manner. Modification, misuse, and/or part substitution shall immediately void your factory warranty and may result in serious injury or death! If you suspect that a part(s) is missing and/or defective, immediately contact Big Game® toll-free at 800-268-5077 for replacement of missing or defective parts. Never modify your stand in any way by making repairs, or altering, adding or attaching anything to it except if explicitly authorized in writing by Big Game®. **ALWAYS USE GENUINE FACTORY AUTHORIZED BIG GAME REPLACEMENT PARTS. USE OF ANY REPLACEMENT PARTS OTHER THAN GENUINE BIG GAME PARTS VOIDS YOUR WARRANTY AND MAY RESULT IN SERIOUS INJURY OR DEATH!**
- ⚠ WARNING! ALWAYS** inspect/check **ALL** expiration dates/tags on all straps and the full-body fall arrest harness and its components prior to each use. You must replace **ALL** straps and suspension seats **EVERY** year. Never use any strap(s) or full-body fall arrest harness that has expired and/or is showing any signs of damage and/or wear. Failure to follow these instructions may result in serious injury and death!
- ⚠ WARNING!** Make certain all chains, cable straps, etc. are tightened per this Instruction Manual prior to use. All treestand contact points must be in contact with the tree before you step onto the stand. The correct adjustment and tightening of attachment hardware is critical to the stable installation of this treestand. Failure to follow these instructions may result in serious injury or death!
- ⚠ WARNING!** This product(s) is designed for adult use only. No one under the age of 16 should attempt to use this or any other product(s) without direct adult supervision. Failure to follow these instructions may result in serious injury or death!
- ⚠ WARNING!** Prior to attempting to use this or any other Big Game® product(s) you must take a moment and become familiar with its assembly, setup and installation. You must practice installing, setting-up and using this product(s) at ground-level prior to attempting to use it at heights above ground-level. Once you have become thoroughly knowledgeable and comfortable with this Big Game® product(s) setup, installation and use at ground-level, you are now ready to use it at heights above ground-level. Failure to follow these instructions may result in serious injury or death!
- ⚠ WARNING!** Several Big Game® treestands are equipped with a footrest, armrests and/or shooting rail. Neither the footrest, armrests nor the shooting rail have been designed to support the users weight. Under no circumstances should you place any more than fifteen (15) pounds of weight on these structures. Doing so will put the user in serious risk of injury or death. Failure to follow these instructions may result in serious injury or death!

This Instruction Manual complies with the Treestand Manufacturers Association's
TMS 04-Standard Practice for Treestand Instructions & TMS 02-Standard Test Method for Treestand Fall Arrest Systems

ATTENTION!!
WHEN YOU SEE A "⚠ WARNING!" BE SURE TO HEED THE MESSAGE!
THE INFORMATION CONTAINED IN THESE MESSAGES
CAN SAVE YOUR LIFE!!

- ⚠ WARNING!** You must wear a Fall Arrest System (FAS) comprising of a full-body fall arrest harness at all times after leaving the ground. You must stay connected at all times after leaving the ground while using fixed position treestands. Single safety belts and chest harnesses are no longer allowed and should never be used. If you are not wearing a full-body fall arrest harness that is properly attached to the tree to protect you from a fall, do not leave the ground. Failure to follow these instructions may result in serious injury or death!
- ⚠ WARNING!** Never attempt to climb up or down with a weapon and/or gear in your possession. **ALWAYS** unload your weapon and pull it up to hunting height using a tether or pull up rope. **ALWAYS** lower your unloaded weapon down to the ground prior (when raising or lowering firearms, the chamber must be open and the barrel pointing toward the ground) to attempting to climb up or climb down. Use this same method when raising or lowering all other gear. Failure to follow these instructions may result in serious injury or death!
- ⚠ WARNING!** Prior to each use thoroughly inspect the treestand and all safety devices each time before use for signs of wear, rot, corrosion, cracks, deterioration and/or any other type of defect. Make certain that your treestand is tight and secure prior to use. Protect this product from extended exposure to direct sunlight, excessive heat or freezing temperatures by storing inside when not in use. Do not use this or any other product(s) if it shows evidence of wear, rot, corrosion, cracks, deterioration and/or any other type of defect. Failure to follow these instructions may result in serious injury or death!
- ⚠ WARNING! DO NOT** use this or any other Big Game® products(s) if you have a history of heart problems, back problems, impaired vision, joints that lock-up, spinal fusions, equilibrium problems, high blood pressure, are not well-rested and/or any other physical impairment that may limit your ability to use and/or operate this product(s) in the safe manner outlined in this Instruction Manual. Additionally, do not use this or any other Big Game® product(s) if you are currently taking medication (including prescription) and/or using and/or consuming any substance, including alcohol, that may limit your ability to use this Big Game® product(s) as outlined and described in the Instruction Manual. Never use a treestand when feeling ill, nauseous or dizzy. Failure to follow these instructions may result in serious injury or death!
- ⚠ WARNING! DO NOT** attempt to make adjustments to this product while in the treestand. All adjustments must be made with the entire treestand on the ground. Failure to follow these instructions may result in serious injury or death!

This Instruction Manual complies with the Treestand Manufacturers Association's
TMS 04-Standard Practice for Treestand Instructions & TMS 02-Standard Test Method for Treestand Fall Arrest Systems

READ THIS MANUAL IN ITS ENTIRETY PRIOR TO USING THIS PRODUCT.

ATTENTION!!
WHEN YOU SEE A "⚠ WARNING!" BE SURE TO HEED THE MESSAGE!
THE INFORMATION CONTAINED IN THESE MESSAGES
CAN SAVE YOUR LIFE!!

- ⚠ WARNING! DO NOT** leave your Big Game® product(s) installed for more than two weeks (14 days). Any number of factors can jeopardize its installation and integrity. These include, but are not limited to, weather or other environmental factors that can negatively affect its performance. Animals can also cause damage to your Big Game® product(s) that can negatively affect its performance and your safety. Additionally, factors such as tree growth can stress and damage supporting straps, chains and/or buckles. Failure to follow these instructions may result in serious injury or death!
- ⚠ WARNING! ALWAYS** inspect the treestand and all safety devices prior to each use. **DO NOT** use product if it shows signs of wear, damage, deterioration, or vandalism. Factors such as tree growth, vandals, weather and animals may affect the performance of an unattended treestand. Failure to follow these instructions may result in serious injury or death!
- ⚠ WARNING! DO NOT** modify, fix/repair, alter, bend, cut, weld, or heat the treestand in any way. Also, do not attach anything to your treestand without explicit authorized and written instructions from the manufacturer. Failure to follow these instructions will void your warranty and may result in serious injury or death!
- ⚠ WARNING!** Strict weight limitations have been set for each product to ensure your personal safety. Note the weight limitations of your stand and that this weight limit includes the user and equipment. **NEVER EXCEED THESE WEIGHT LIMITATIONS!** Failure to follow these instructions may result in serious injury or death!
- ⚠ WARNING! DO NOT** attempt to use this or any other Big Game® product(s) when ice, snow, and/or freezing rain has deposited or formed on any portion of the tree or stand you intend to climb. Do not attempt to use this or any other Big Game® product(s) when thunderstorms are threatening and/or present within five (5) miles. Do not attempt to use this or any other product(s) when any other adverse weather condition presents itself. These include, but are not limited to, weather conditions which have the potential for producing winds, lightning, rain, snow, sleet and/or any other atmospheric condition which may limit the user's ability to operate this Big Game® product(s) in a safe manner as described in this Instruction Manual. Should inclement weather conditions arise during your use of this Big Game® product(s), return to the ground immediately. Failure to follow these instructions may result in serious injury or death!
- ⚠ WARNING! DO NOT** jump or bounce on the treestand platform and/or the seat to engage the stand to the tree. Failure to follow these instructions may result in serious injury or death!

This Instruction Manual complies with the Treestand Manufacturers Association's
TMS 04-Standard Practice for Treestand Instructions & TMS 02-Standard Test Method for Treestand Fall Arrest Systems

ATTENTION!!
WHEN YOU SEE A "⚠ WARNING!" BE SURE TO HEED THE MESSAGE!
THE INFORMATION CONTAINED IN THESE MESSAGES
CAN SAVE YOUR LIFE!!

- ⚠ WARNING! BEFORE** each use, make sure all nuts and bolts are secure. **CHECK** all hardware and webbing prior to every use to make sure that no damage has occurred to hardware and that webbing (as applicable) is not cut or frayed. Keep webbing from coming into contact with any sharp edges. **DO NOT USE THIS PRODUCT IF ANY DAMAGE IS SUSPECTED.** Failure to follow these instructions may result in serious injury or death!
- ⚠ WARNING! REPLACE** any damaged or worn part with original parts. Replace attachment belts every three years and when not in use store in a dry, cool, safe place away from sunlight. Never store a treestand or any of its components outdoors when not in use. To purchase parts contact us at 800-268-5077. Failure to follow these instructions may result in serious injury or death!
- ⚠ WARNING! ALWAYS** wear the appropriate foot wear when using a treestand. A good non-slip safety boot is important for your safety. Be especially careful that boot laces do not get hooked on the tree stand or climbing aids (tuck shoelaces into boot before climbing). Failure to follow these instructions may result in serious injury or death!
- ⚠ WARNING! DO NOT** use this product, or attempt to use a treestand, on a dead, leaning, diseased, loose barked tree (bark that flakes or falls off), irregular shaped trees, or utility poles. **DO NOT** use this product on any tree that does not allow for a level standing platform. Failure to follow these instructions may result in serious injury or death!
- ⚠ WARNING! NEVER** hunt out of a treestand at heights at which you are not completely comfortable. Depending upon the tree and hunting conditions, choose the minimum hunting height that allows for safe, effective hunting. Failure to follow these instructions may result in serious injury or death!
- ⚠ WARNING! DO NOT** use this, or any other product(s) to climb utility poles, telephone poles, structural columns or any other man-made structures. Never use this or any other product(s) around power generation (e.g., transformers, generators, substations, etc.) and/or power transmission equipment. Never use a treestand on a dead, leaning, diseased or loose barked tree. **NEVER USE A TREE BRANCH, OR ANY PORTION OF A TREE, TO SUPPORT ANY PORTION OF YOUR WEIGHT OR AS A HAND HOLD.** Failure to follow these instructions may result in serious injury or death!
- ⚠ WARNING! DO NOT** stand on the treestand seat. Failure to follow these instructions may result in serious injury or death!
- ⚠ WARNING!** This Big Game® product(s) was designed for installation on trees with a minimum diameter of nine (9) inches. **DO NOT** use your Big Game® product(s) on trees with trunk diameters that do not meet this minimum diameter requirement. Failure to follow these instructions may result in serious injury or death!

This Instruction Manual complies with the Treestand Manufacturers Association's
TMS 04-Standard Practice for Treestand Instructions & TMS 02-Standard Test Method for Treestand Fall Arrest Systems

READ THIS MANUAL IN ITS ENTIRETY PRIOR TO USING THIS PRODUCT.

ATTENTION!!
WHEN YOU SEE A "⚠ WARNING!" BE SURE TO HEED THE MESSAGE!
THE INFORMATION CONTAINED IN THESE MESSAGES
CAN SAVE YOUR LIFE!!

- ⚠ WARNING!** A minimum of three (3) adults is required to install and/or remove a ladderstand. Failure to follow these instructions may result in serious injury or death!
- ⚠ WARNING!** The criss-cross straps and stabilization devices must be attached before attempting to climb to the seating/standing platforms. Failure to follow these instructions may result in serious injury or death!
- ⚠ WARNING!** When installing a ladderstand, always apply weight on the first rung to set the ladder firmly into the ground. Failure to follow these instructions may result in serious injury or death!
- ⚠ WARNING!** Check the ground under ladderstands and climbing systems to make sure it is firm and level. Sloping ground or uneven surfaces (one side on a rock) can cause the ladder to tilt or shift off the tree as you climb. Failure to follow these instructions may result in serious injury or death!
- ⚠ WARNING! ALWAYS** maintain three-point contact when climbing up/down a tree when using climbing aids. Proper three-point contact means having either two feet with one hand or one foot with two hands on the step portion of the climbing aids at all times when climbing up or down. Failure to follow these instructions may result in serious injury or death!
- ⚠ WARNING! ALWAYS** lean forward as you climb and attach your full-body fall arrest harness to the tree before securing the platform to the tree and stepping onto the platform. Failure to follow these instructions may result in serious injury or death!

Should you have any questions about the assembly, installation or use of this product, or any other product, please do not hesitate to call one of our customer service representatives at 800-268-5077 and they will answer all questions you may have about any of the complete line of products.

To activate your product's warranty, a registration card can be found on page 103 and must be completed and returned to the manufacturer within 30 days of purchase. Be sure to keep a copy of this for your records.

OPTIONAL ACCESSORIES AND REPLACEMENT PARTS

Any number of innovative accessories are available and sold separately to compliment your new climbing system. Only genuine authorized accessories should be used with your climbing system. Genuine replacement parts are also available online or via telephone. Should you require parts or service, or if you just have a question about this, or any other product(s), simply give one of our customer service representatives a call toll-free at 800-268-5077 or visit www.biggametreestands.com

This Instruction Manual complies with the Treestand Manufacturers Association's
 TMS 04-Standard Practice for Treestand Instructions & TMS 02-Standard Test Method for Treestand Fall Arrest Systems

ATTENTION!!
WHEN YOU SEE A "⚠ WARNING!" BE SURE TO HEED THE MESSAGE!
THE INFORMATION CONTAINED IN THESE MESSAGES
CAN SAVE YOUR LIFE!!

FULL-BODY FALL ARREST HARNESS USAGE INSTRUCTIONS & WARNINGS

⚠ WARNING! Failure to read and strictly comply with the instructions contained here may result in serious injury or death!

READ THE FULL-BODY FALL ARREST HARNESS MANUAL CAREFULLY AND FOLLOW ALL OF THE INSTRUCTIONS! YOUR FULL-BODY FALL ARREST HARNESS IS DESIGNED FOR A MAXIMUM CAPACITY (USER AND EQUIPMENT) OF 300 POUNDS (136 kg). ADDITIONALLY, YOUR FULL-BODY FALL ARREST HARNESS MUST BE REPLACED AFTER THREE (3) YEARS OF SERVICE! PLEASE CONTACT US FOR FULL-BODY FALL ARREST HARNESS REPLACEMENT PROCEDURE SHOULD YOU EXPERIENCE A FALL OR SHOULD IT EXCEED THE THREE (3) YEAR SERVICE PERIOD.

⚠ WARNING! Prior to attempting to use this or any other product(s) you must take a moment and become familiar with its assembly, setup and installation. You must practice installing, setting-up and using your full-body fall arrest harness at ground-level prior to attempting to use it at heights above ground-level. Once you have become thoroughly knowledgeable and comfortable with this product(s) setup, installation, and use at ground-level, you are now ready to use it at heights above ground-level. Failure to follow these instructions may result in serious injury or death!

⚠ WARNING! You must wear a Fall Arrest System (FAS) comprising of a full-body fall arrest harness at all times after leaving the ground. You must stay connected at all times after leaving the ground while using fixed position treestands. Single safety belts and chest harnesses are no longer preferred and should never be used. If you are not wearing a full-body fall arrest harness that is protecting you from a fall, do not leave the ground. Failure to follow these instructions may result in serious injury or death!

⚠ WARNING! You must practice putting the full-body fall arrest harness on, adjusting, and using your full-body fall arrest harness at ground-level in the presence of a **responsible adult** to experience the feeling of hanging suspended before using in a hunting environment. This experience will ensure you remain calm and collected should you experience a fall while hunting. Failure to follow these instructions may result in serious injury or death!

⚠ WARNING! The length of the full-body fall arrest harness tether must be kept to a minimum at all times during use. It should be adjusted so that it is above the head with no slack (snug) in the sitting position and you should have the minimum amount of slack possible when climbing. Never let the tether strap get under your chin or around your neck. Failure to follow these instructions may result in serious injury or death!

⚠ WARNING! Should you experience a fall there is time to make a correct decision on what action needs to take place. It is important to remember: **DO NOT PANIC!** Failure to follow this warning may result in serious injury or death!

This Instruction Manual complies with the Treestand Manufacturers Association's
TMS 04-Standard Practice for Treestand Instructions & TMS 02-Standard Test Method for Treestand Fall Arrest Systems

READ THIS MANUAL IN ITS ENTIRETY PRIOR TO USING THIS PRODUCT.

ATTENTION!!
WHEN YOU SEE A "⚠ WARNING!" BE SURE TO HEED THE MESSAGE!
THE INFORMATION CONTAINED IN THESE MESSAGES
CAN SAVE YOUR LIFE!!

- ⚠ WARNING!** If you have a limiting physical and/or health condition that precludes and/or renders you incapable of self-recovery and/or a suitable escape plan is not available, **DO NOT** hunt from heights above ground-level. Failure to follow these instructions may result in serious injury or death!
- ⚠ WARNING!** FALLS FROM A TREESTAND CAN OCCUR ANYTIME AFTER LEAVING THE GROUND. THESE FALLS COULD RESULT IN EITHER SERIOUS INJURY OR DEATH! FOR YOUR PERSONAL SAFETY, PLEASE TAKE A MOMENT TO CAREFULLY READ THIS PRODUCT INSTRUCTION MANUAL IN ITS ENTIRETY BEFORE ATTEMPTING TO ASSEMBLE, SET-UP, INSTALL, AND/OR OTHERWISE USE THIS BIG GAME® PRODUCT. AT LEAST ANNUALLY, REVIEW THE CONTENTS OF THIS INSTRUCTION MANUAL AND WATCH THE *TREESTAND SAFETY: IT'S UP TO YOU* DVD. ADDITIONALLY, KEEP THESE INSTRUCTIONS FOR THE ENTIRE DURATION THAT YOU OWN THIS PRODUCT(S). FAILURE TO FOLLOW THESE INSTRUCTIONS MAY RESULT IN SERIOUS INJURY OR DEATH!
- ⚠ WARNING!** THE SAFE USE AND OPERATION OF THIS PRODUCT IS THE SOLE RESPONSIBILITY OF THE USER. IT IS ALSO THE SOLE RESPONSIBILITY OF THE OWNER TO PROVIDE ANY PERSON(S) WHO BORROW OR PURCHASE THIS PRODUCT FROM THEM WITH THESE COMPLETE INSTRUCTIONS. FAILURE TO FOLLOW THESE INSTRUCTIONS MAY RESULT IN SERIOUS INJURY OR DEATH! ADDITIONALLY, FAILURE TO FOLLOW THESE INSTRUCTIONS MAY SUBJECT YOU TO PERSONAL LIABILITY PENALTIES AS DETERMINED BY THE U.S. JUDICIAL SYSTEM.
- ⚠ WARNING!** Prior to each hunt, make sure that you have a signaling device (e.g., mobile phone, radio, whistle, signal flare, Personal Locator Device [PLD], etc.) in your possession and on your person in an operable condition. This device must be within easy access should you experience the need to contact emergency assistance. Failure to follow these instructions may result in serious injury or death!
- ⚠ WARNING!** Practice the use of your Big Game® full-body fall arrest harness and Suspension Relief Device (SRD) at ground-level in the presence of a responsible adult to experience the feeling of hanging suspended before using in a hunting environment. Failure to follow these instructions may result in serious injury or death!
- ⚠ WARNING! NEVER** allow the full-body fall arrest harness tether to get under your chin or around your neck. This poses a choking hazard that can lead to serious injury or death. Failure to follow these instructions may result in serious injury or death!
- ⚠ WARNING!** If your hunting location is unknown by anyone and communication efforts are unsuccessful, you must have a personal plan for self-recovery/escape should you experience a fall. Prolonged suspension in a full-body fall arrest harness can be fatal. It is important to exercise the legs by pushing against the tree or doing other forms of continuous leg exercises to avoid blood pooling while being suspended. Varying degrees of physical fitness may require different plans for self-recovery/escape the effects of prolonged suspension. Have a personal plan and practice it in the presence of a responsible adult before leaving the ground.

This Instruction Manual complies with the Treestand Manufacturers Association's
 TMS 04 - Standard Practice for Treestand Instructions & TMS 02 - Standard Test Method for Treestand Fall Arrest Systems

ATTENTION!!
WHEN YOU SEE A "⚠ WARNING!" BE SURE TO HEED THE MESSAGE!
THE INFORMATION CONTAINED IN THESE MESSAGES
CAN SAVE YOUR LIFE!!

No one escape/rescue plan will work for every hunter, on every tree, in every circumstance. Only you can determine the best self-recovery/escape plan for your hunting situation before leaving the ground. There is time to make a correct decision on what action to take if a fall occurs while wearing a full-body fall arrest harness. It is important to remember, **DO NOT PANIC**. Remain calm and implement your practiced rescue, relief and recovery plan. Hunt from the ground when a self-recovery/escape ability is absent. Failure to follow these instructions may result in serious injury or death!

FULL-BODY FALL ARREST HARNESS INSTRUCTIONS

⚠ WARNING! READ THESE BIG GAME® TREESTANDS FULL-BODY FALL ARREST HARNESS INSTRUCTIONS CAREFULLY AND FOLLOW ALL THE INSTRUCTIONS! YOUR NEW FULL-BODY FALL ARREST HARNESS IS DESIGNED FOR A MAXIMUM CAPACITY (USER AND EQUIPMENT) OF 300 POUNDS (136 kg). ADDITIONALLY, YOUR NEW FULL-BODY FALL ARREST HARNESS MUST BE REPLACED AFTER THREE (3) YEARS OF SERVICE! REPLACE YOUR FULL-BODY FALL ARREST HARNESS IMMEDIATELY SHOULD YOU EXPERIENCE A FALL WHILE WEARING IT.

⚠ WARNING! Use the Big Game® Treestands' full-body fall arrest harness provided with this product or similar TMA certified harness. NOTE: You must store your full-body fall arrest harness out of direct sunlight and out of any other harsh environmental condition(s) that may adversely affect its performance. Failure to follow these instructions may result in serious injury or death!

STEP 1. Identify the main parts of the full-body fall arrest harness (fig. 1). Hold the full-body fall arrest harness by the tether loop insuring the harness is upright and leg straps are hanging down. Straighten any parts that have become twisted. Insert arms through each shoulder strap. (fig. 2)

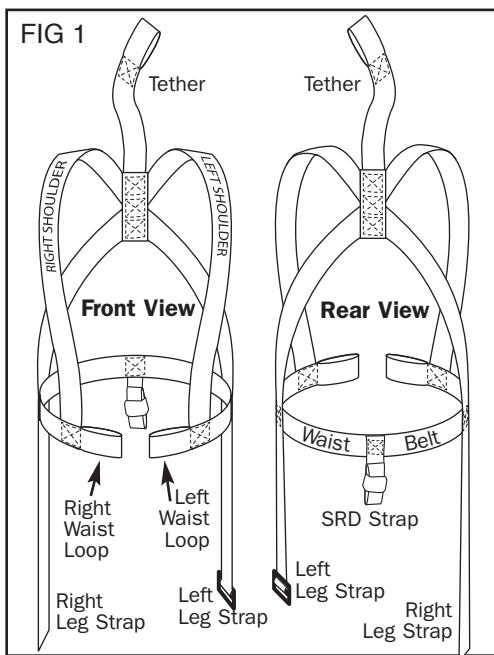

This Instruction Manual complies with the Treestand Manufacturers Association's TMS 04-Standard Practice for Treestand Instructions & TMS 02-Standard Test Method for Treestand Fall Arrest Systems

READ THIS MANUAL IN ITS ENTIRETY PRIOR TO USING THIS PRODUCT.

ATTENTION!!
WHEN YOU SEE A "⚠️ WARNING!" BE SURE TO HEED THE MESSAGE!
THE INFORMATION CONTAINED IN THESE MESSAGES
CAN SAVE YOUR LIFE!!

STEP 2. Feed the left leg strap between legs and thread through the bottom left waist loop. Repeat with the right leg strap, feeding between legs and through right waist loop. (fig. 3)

STEP 3. Secure the two leg straps by threading the 3 bar buckle as shown in Figure 4. Tighten the leg straps snugly. **DO NOT** over tighten as this will cut off the circulation to your leg. The Big Game® Treestands full-body fall arrest harness should look like the one depicted in Figure 6 when donned correctly.

NOTE: If leg straps are too long, feed left leg strap with buckle through bottom of the left waist loop, down the top of the right waist loop and secure to right leg strap with 3 Bar Buckle as instructed.

⚠️ WARNING! It is very important to complete this step of the assembly. An improperly secured buckle may cause full-body fall arrest harness failure resulting in serious injury or death! If there is not enough strap available to complete this step, **DO NOT USE THIS FULL-BODY FALL ARREST HARNESS!** You may need to purchase and use a larger specialty sized TMA Certified full-body fall arrest harness.

STEP 4. If necessary to use a climbing belt for the field installation of your treestand, feed the climbing belt through one of the waist loops and wrap the free end around the tree. Then feed opposite end through the opposite waist loop and use 3 bar buckle method described in Figure 4 to secure. (fig. 5)

STEP 5. Once you have reached your desired height, insert the tree belt through the loop of the tether. (fig. 6) Then, carefully wrap the tree belt around the tree at a height that allows just enough slack for you to sit comfortably in your stand. Keeping the tether as short as possible limits the distance you will travel in case of a fall. To secure the strap, insert free end up through the slot in the buckle closest to opposite end of the tree belt strap, then cross over the sliding mechanism and back down through opposite slot. Pull on strap to secure and test to make sure sliding mechanism engages, creating secure strap placement. (fig. 7, 8, 9)

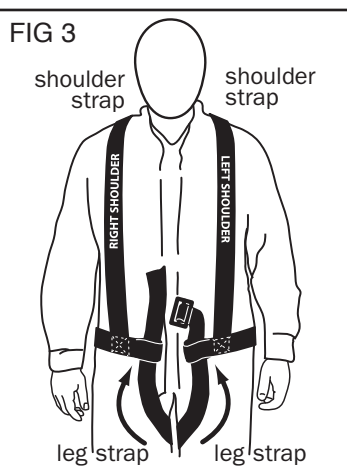
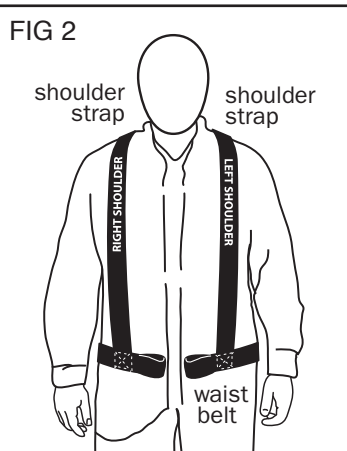

This Instruction Manual complies with the Treestand Manufacturers Association's
 TMS 04 - Standard Practice for Treestand Instructions & TMS 02 - Standard Test Method for Treestand Fall Arrest Systems

READ THIS MANUAL IN ITS ENTIRETY PRIOR TO USING THIS PRODUCT.

ATTENTION!!
WHEN YOU SEE A "⚠ WARNING!" BE SURE TO HEED THE MESSAGE!
THE INFORMATION CONTAINED IN THESE MESSAGES
CAN SAVE YOUR LIFE!!

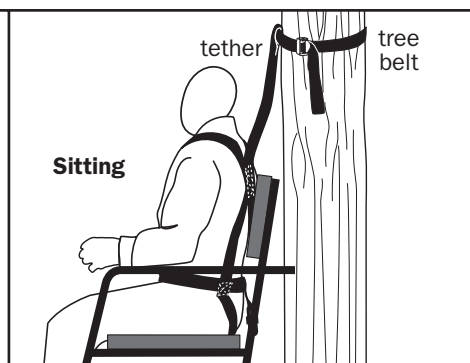
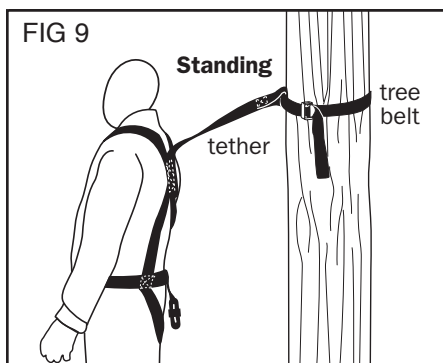
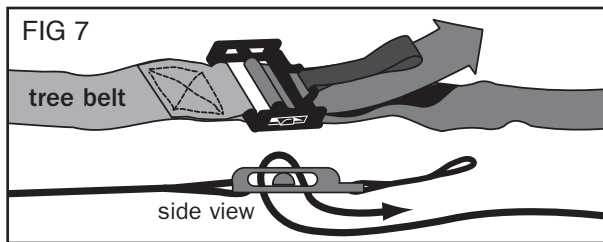
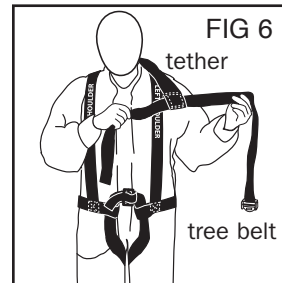
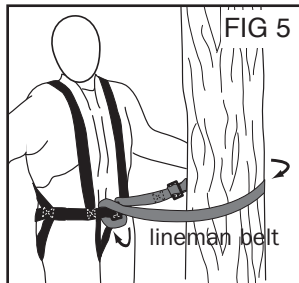
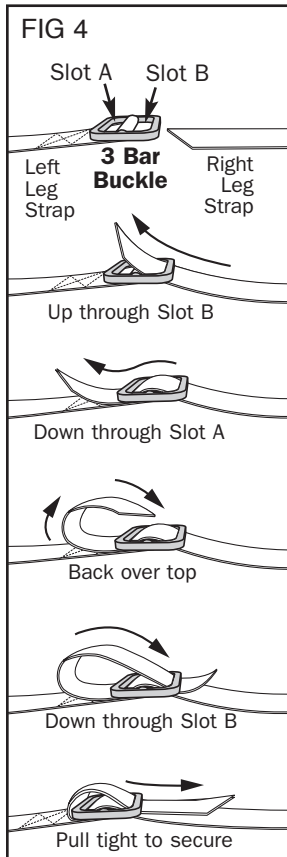

This Instruction Manual complies with the Treestand Manufacturers Association's
 TMS 04- Standard Practice for Treestand Instructions & TMS 02- Standard Test Method for Treestand Fall Arrest Systems

READ THIS MANUAL IN ITS ENTIRETY PRIOR TO USING THIS PRODUCT.

STEPS TO FOLLOW IF A FALL WAS TO OCCUR:

Although no one plans to fall from their treestand, falls can and do occur without warning. It is important to become familiar with the guidelines below and practice your recovery plan at ground-level. Failure to read, understand, and follow these steps may result in serious injury or death!

⚠ WARNING! There is time to make a correct decision on what action to take if a fall occurs while wearing a full-body fall arrest harness. It is important NOT TO PANIC! Remain calm and implement your practiced rescue, relief and recovery plan. Failure to follow this warning may result in serious injury or death!

⚠ WARNING! A suspension relief device must be on your person and readily accessible while using a full-body fall arrest harness. These devices will allow you to relieve the load on the lower extremities if suspended in a full-body fall arrest harness and help maintain circulation in the legs and mitigate suspension trauma (blood pooling) or allow descent to the ground. Follow all instructions below regarding the provided SRD (Suspension Relief Device) and NEVER remove it from your full-body fall arrest harness. Failure to follow full-body fall arrest harness instructions could result in not being able to return to the stand and being suspended in a full-body fall arrest harness after a fall. Failure to follow this warning may result in serious injury or death!

STEP 1. After a fall, take a moment to catch your breath and stay calm; **DO NOT PANIC.**

STEP 2. Pull on the **SRD strap** located on the lower back side of your **full-body fall arrest harness**. (see fig. 10)

STEP 3. Adjust the **SRD strap** so that you are able to step into the loop and then stand up, relieving the pressure on your lower extremities. The loop size can be adjusted by moving the buckle up or down. (see fig. 11 & 12)

STEP 4. If you are able to reach your ladder or climbing system, use it to get back into your secured treestand and then carefully climb down to ground-level. If you are not able to reach your stand, remain calm and continue to stand in the **SRD loop** until help arrives. (see fig. 13)

STEP 5. Use your **personal locating device** or **cell phone** to call for help.

NOTE: Several optional products/systems are available that offer self-recovery or self-extraction from a fall when suspended in a full-body fall arrest harness. Some systems automatically descend the user while others allow user control. One of these products/systems can be considered for use as an additional safety precaution against prolonged suspension and suspension trauma. Be sure to follow the manufacturers' directions on the safe use of these products/systems.

This Instruction Manual complies with the Treestand Manufacturers Association's
TMS 04-Standard Practice for Treestand Instructions & TMS 02-Standard Test Method for Treestand Fall Arrest Systems

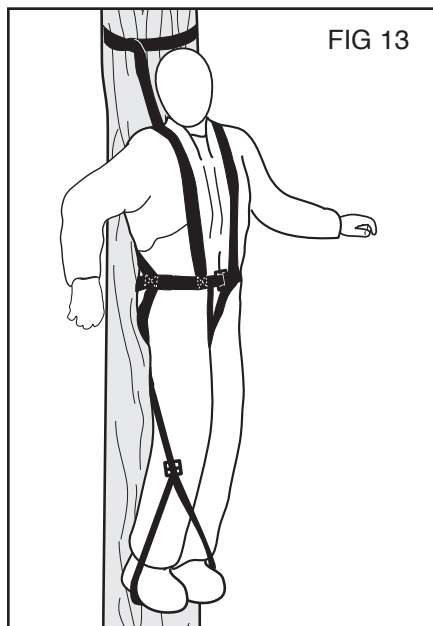
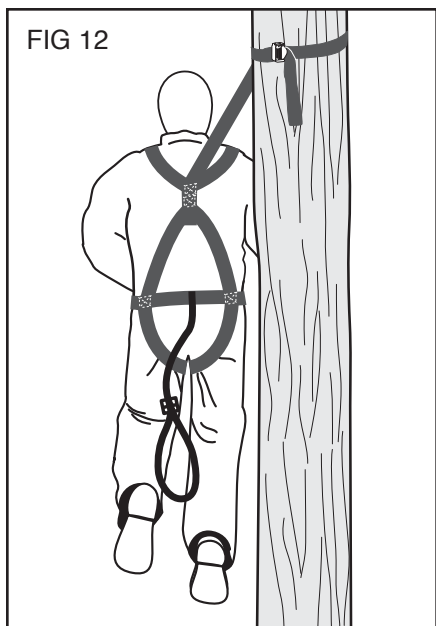
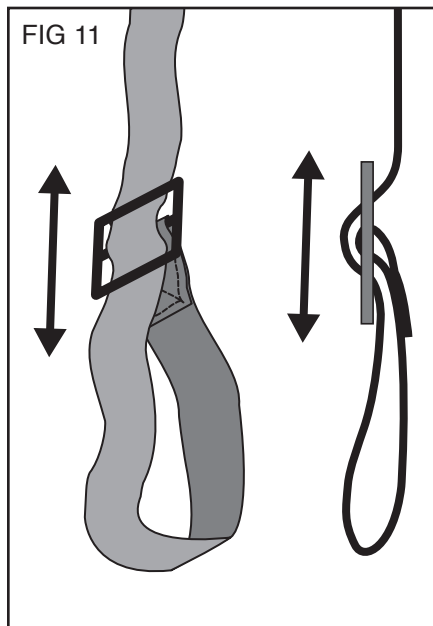
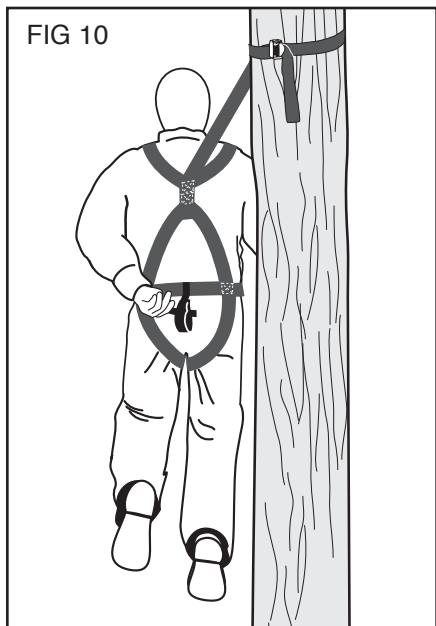

This Instruction Manual complies with the Treestand Manufacturers Association's
TMS 04-Standard Practice for Treestand Instructions & TMS 02-Standard Test Method for Treestand Fall Arrest Systems

READ THIS MANUAL IN ITS ENTIRETY PRIOR TO USING THIS PRODUCT.

CR3901-S THE ULTRA-VIEW™ DX

⚠ WARNING! Read the WEIGHT RESTRICTION WARNING, USAGE INSTRUCTIONS & WARNINGS and FULL-BODY FALL ARREST HARNESS USAGE INSTRUCTIONS & WARNINGS on pages 4-17 prior to assembly of this product! Failure to follow the instructions on this page and pages 4-17 may result in serious injury or death!

⚠ WARNING! DO NOT over tighten the hardware. Over tightening can lead to structural damage and may negatively affect the performance of your stand. Failure to follow these instructions may result in serious injury or death!

Refer to pages 88-95, **Field Installation-Ladderstands**, for installation instructions.

NOTE: Steps 1-11 require you to temporarily finger tighten nuts to ensure proper alignment. All bolts should be installed from the inside with nylock nuts on the outside.

STEP 1. First, attach the **left foot platform** to the **right foot platform** using (3) 1/4" x 2 1/2" hex bolts [L] and (3) 1/4" nylock nuts to secure. (fig. 1)

STEP 2. Next attach the **top ladder section** and **foot rest** to the **left/right foot platforms** using (2) 1/4" x 1 3/4" hex bolts [A], (4) nylon washers and (2) 1/4" nylock nuts. (fig. 1)

STEP 3. Using (2) 5/16" x 2 1/2" hex bolts [I] and (2) 5/16" nylock nuts attach the **left outer foot platform** to the **left foot platform**. Repeat for right side. (fig. 1)

STEP 4. Attach the **platform support** to the **left/right foot platforms** using (4) 1/4" x 3" hex bolts [B] and (4) 1/4" nylock nuts. **NOTE:** The **seat hub bracket** on the **platform support** should be toward the rear of the unit. (fig. 2)

STEP 5. Attach the **seat hub** to **left/right foot platforms** using (2) 5/16" x 1 3/4" hex bolts [F] and (2) 5/16" nylock nuts. Then, attach the **seat hub** to the **seat hub bracket** using (2) 5/16" x 3/4" hex bolts [C]. (fig. 2)

STEP 6. Insert the **seat post** into the **seat hub**. Then assemble the **seat platform** onto the **seat post**. **NOTE:** (2) 4" nylon washers should be added between **seat post** and **seat hub** and between **seat post** and **seat platform**. Using (2) 5/16" x 1 1/4" hex bolts [D] and (2) 5/16" nylock nuts attach the **backrest** to the **seat platform** at desired height. (fig. 2)

STEP 7. Next attach the **platform gussets** to the outside of the **left and right outer foot platforms** and to the inside of the **top ladder section** using (4) 5/16" x 2 1/4" hex bolts [H] and (4) 5/16" nylock nuts. (fig. 3)

STEP 8. Next attach the **left/right under support gussets** to the **platform support** using (2) 5/16" x 1 1/4" hex bolts [D] and (2) 5/16" nylock nuts. Then, attach the **left/right under support gussets** to the outside of the **top ladder section** using (2) 1/4" x 2 1/4" hex bolts [K] and (2) 1/4" nylock nuts. (fig. 3)

STEP 9. Attach the **rail supports** to the **left and right foot platforms** and **left and right outer foot platforms** using (8) 5/16" x 1 1/2" hex bolts [E] and (8) 5/16" nylock nuts. Then attach the **rear rail supports** in the same method using (4) 5/16" x 1 1/2" hex bolts [E] and (4) 5/16" nylock nuts to secure. (fig. 4)

This Instruction Manual complies with the Treestand Manufacturers Association's
TMS 04 - Standard Practice for Treestand Instructions & TMS 02 - Standard Test Method for Treestand Fall Arrest Systems

STEP 10. Assemble the rail by sleeving the rear rails into the front rails and secure using (2) 1/4" x 1 1/4" hex bolts [J] and (2) 1/4" nylock nuts. Next insert the rail connector into each end of the front rails, aligning holes. (fig. 4)

STEP 11. Attach the assembled rail to the outside of the (4) rail supports and the (2) rear rail supports using (6) 5/16" x 2" hex bolts [G] and (6) 5/16" nylock nuts. (fig. 4)

STEP 12. SECURELY TIGHTEN EVERY NUT AND BOLT AT THIS TIME.

STEP 13. Attach shooting rail cover, seat cushion and backrest cushion. (fig. 4)

To activate your product's warranty, a registration card can be found on page 103 and must be completed and returned to the manufacturer within 30 days of purchase. Be sure to keep a copy of this for your records.

Parts List (CR3901-S)					
Part #	Description	Qty	Part #	Description	Qty
UP11-0155	S - Top Ladder Section	1	UP10-0027	Ratchet Strap	1
UP10-0172	S - Middle Ladder Section	1	UP10-0182	Rope	1
UP10-0173	S - Bottom Ladder Section	1	UP10-0183	Stabilizer Strap	2
UP11-0006	Left Foot Platform	1	UP10-0008	Full Body Harness	1
UP11-0007	Right Foot Platform	1	UP10-0660	Treestand Safety DVD	1
UP11-0008	Left Outer Foot Platform	1	UP12-0009	Owners Manual	1
UP11-0009	Right Outer Foot Platform	1		Hardware Pack	1
UP10-0195	Platform Support	1	UP77-0021	[A] 1/4" x 1 3/4" Hex Bolt	3
UP11-0010	Platform Gusset	2	UP77-0027	[B] 1/4" x 3" Hex Bolt	4
UP11-0011	Backrest	1	UP77-0035	[C] 5/16" x 3/4" Hex Bolt	2
UP10-0051	Backrest Cushion	1	UP77-0036	[D] 5/16" x 1 1/4" Hex Bolt	4
UP11-0013	Seat Frame	1	UP77-0038	[E] 5/16" x 1 1/2" Hex Bolt	12
UP11-0014	Seat Cushion	1	UP77-0039	[F] 5/16" x 1 3/4" Hex Bolt	2
UP11-0015	Seat Post	1	UP77-0041	[G] 5/16" x 2" Hex Bolt	4
UP11-0016	Seat Hub	1	UP77-0044	[H] 5/16" x 2 1/4" Hex Bolt	6
UP10-0198	Right Under Support Gusset	1	UP77-0043	[I] 5/16" x 2 1/2" Hex Bolt	4
UP10-0199	Left Under Support Gusset	1	UP77-0018	[J] 1/4" x 1 1/4" Hex Bolt	2
UP10-0177	Support Bar - Ladder Piece	1	UP77-0024	[K] 1/4" x 2 1/4" Hex Bolt	2
UP10-0336	Support Bar - Tree Piece	1	UP77-0025	[L] 1/4" x 2 1/2" Hex Bolt	3
UP10-0123	Foot Rest	1	UP77-0030	5/16" Nylon Washer	4
UP10-0529	Rail Support	4	UP77-0064	4" Nylon Washer	2
UP10-0530	Rear Rail Support	2	UP77-0001	1/4" Nylock Nut	13
UP11-0017	Front Rail	2	UP77-0029	5/16" Nylock Nut	32
UP11-0018	Rear Rail	2	UP77-0065	Snap Pin	5
UP11-0019	Rail Connector	1	UP77-0006	1/4" Wing Nut	1
UP11-0020	Rail Cover	1			

TOOLS REQUIRED FOR ASSEMBLY	Adjustable Wrench	Qty 2
------------------------------------	-------------------	-------

CR3901-S SPECIFICATIONS	Min. Tree Diameter • 9 Inches	# Person(s) • ONE (1)
	Max. Weight Capacity (user and equipment) • 300 lb/136 kg	

This Instruction Manual complies with the Treestand Manufacturers Association's TMS 04- Standard Practice for Treestand Instructions & TMS 02- Standard Test Method for Treestand Fall Arrest Systems

READ THIS MANUAL IN ITS ENTIRETY PRIOR TO USING THIS PRODUCT.

CR3901-S FIGURE 1

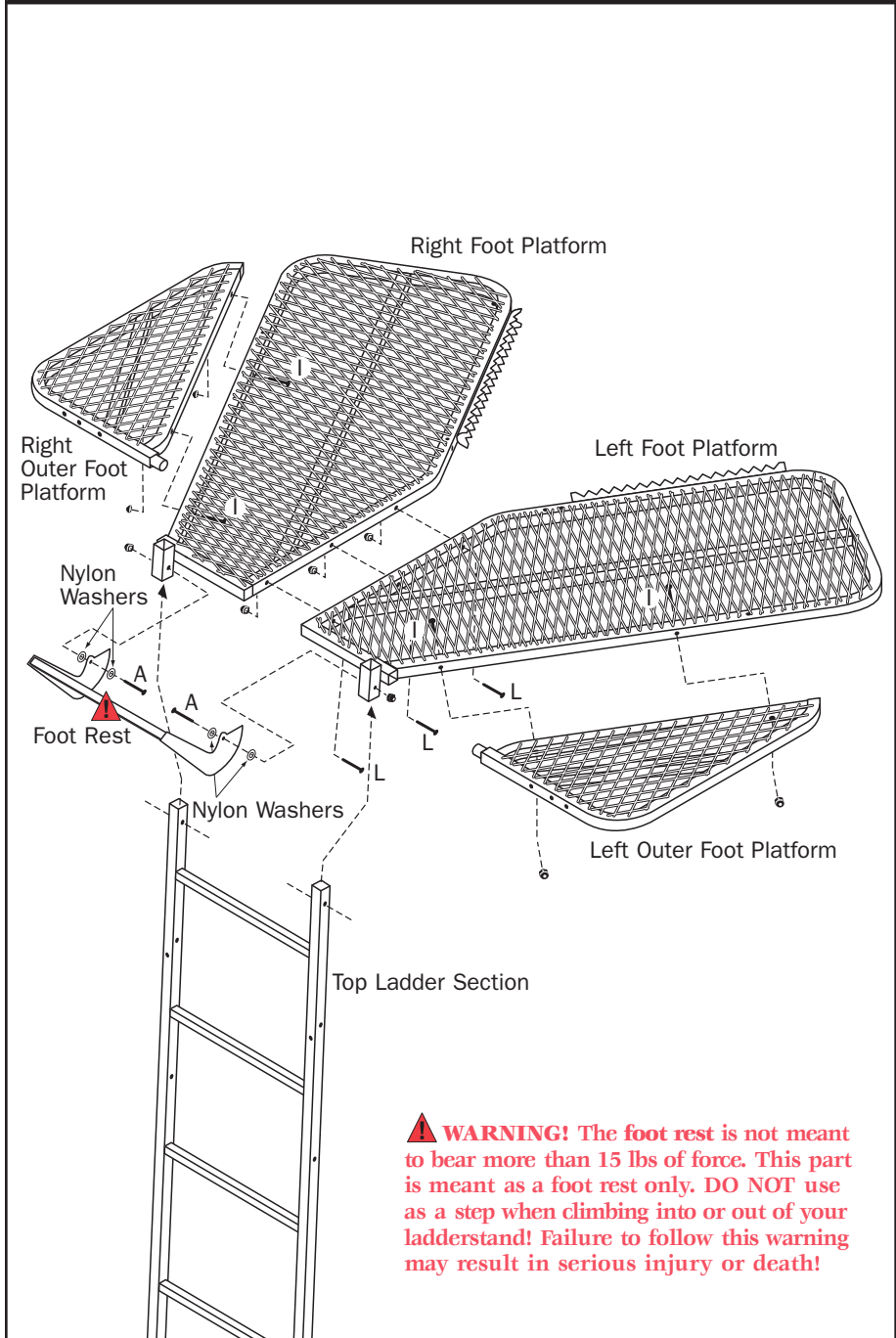

This Instruction Manual complies with the Treestand Manufacturers Association's TMS 04 - Standard Practice for Treestand Instructions & TMS 02 - Standard Test Method for Treestand Fall Arrest Systems

CR3901-S FIGURE 2

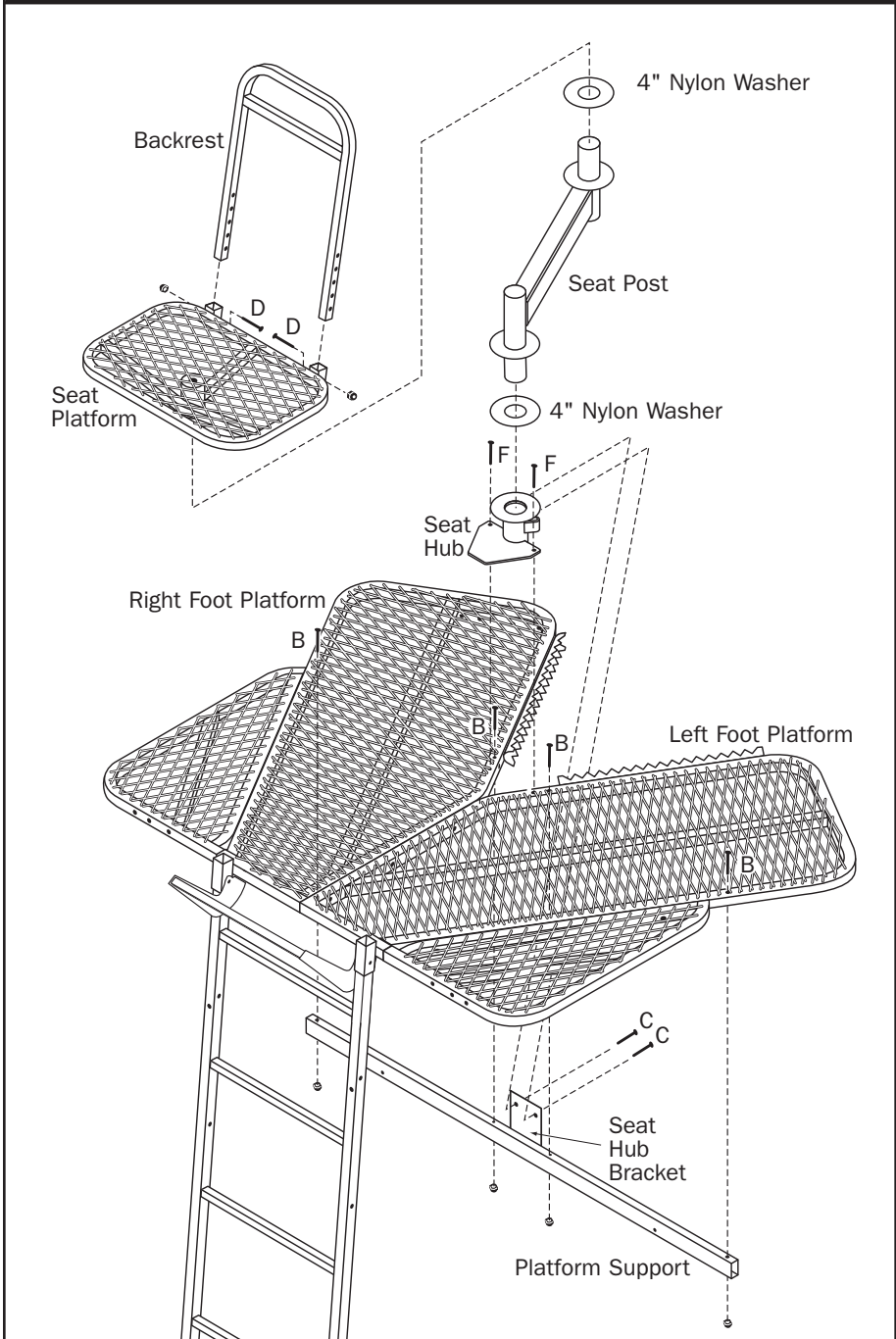

This Instruction Manual complies with the Treestand Manufacturers Association's TMS 04-Standard Practice for Treestand Instructions & TMS 02-Standard Test Method for Treestand Fall Arrest Systems

READ THIS MANUAL IN ITS ENTIRETY PRIOR TO USING THIS PRODUCT.

CR3901-S FIGURE 3

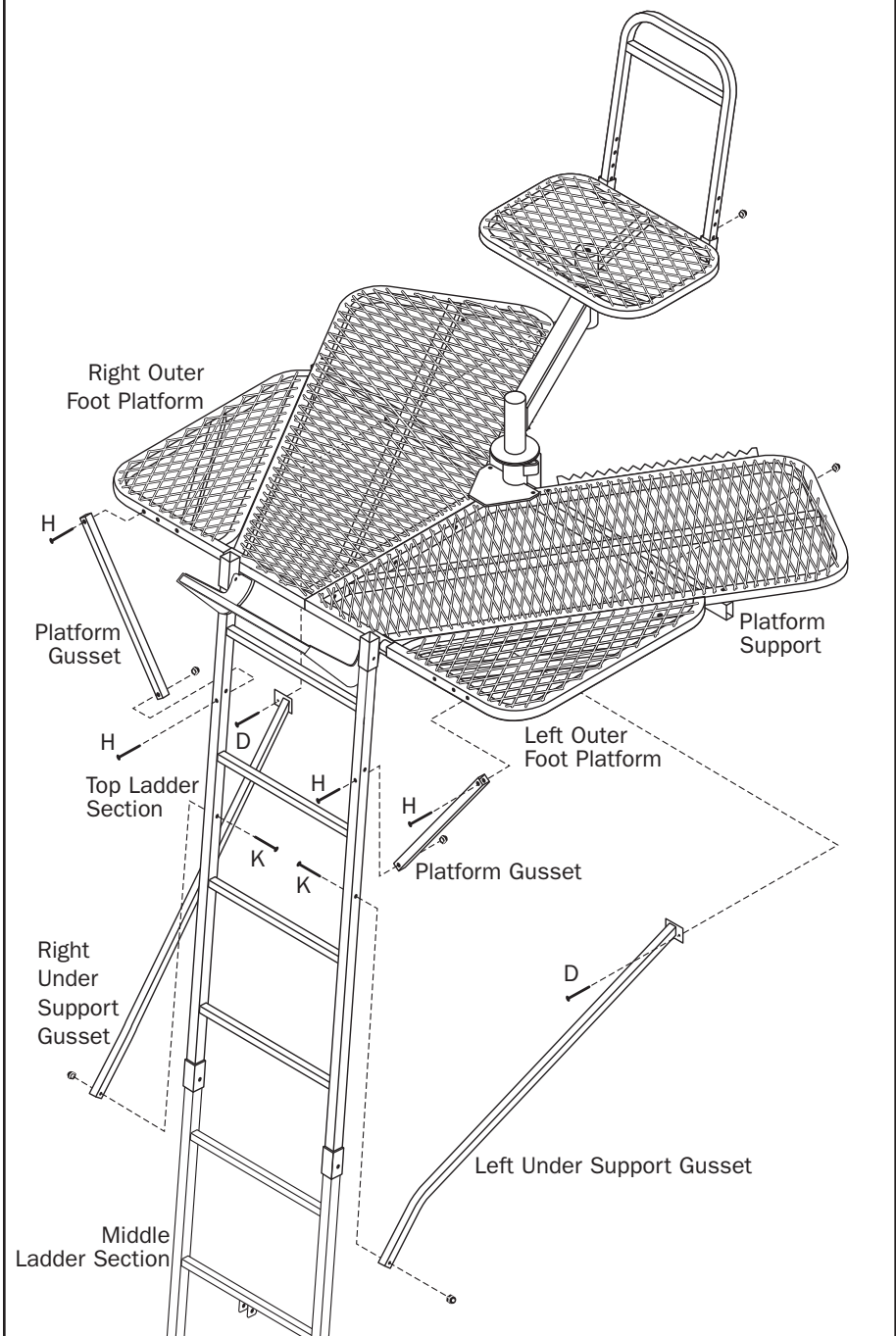

This Instruction Manual complies with the Treestand Manufacturers Association's TMS 04 - Standard Practice for Treestand Instructions & TMS 02 - Standard Test Method for Treestand Fall Arrest Systems

CR3901-S FIGURE 4

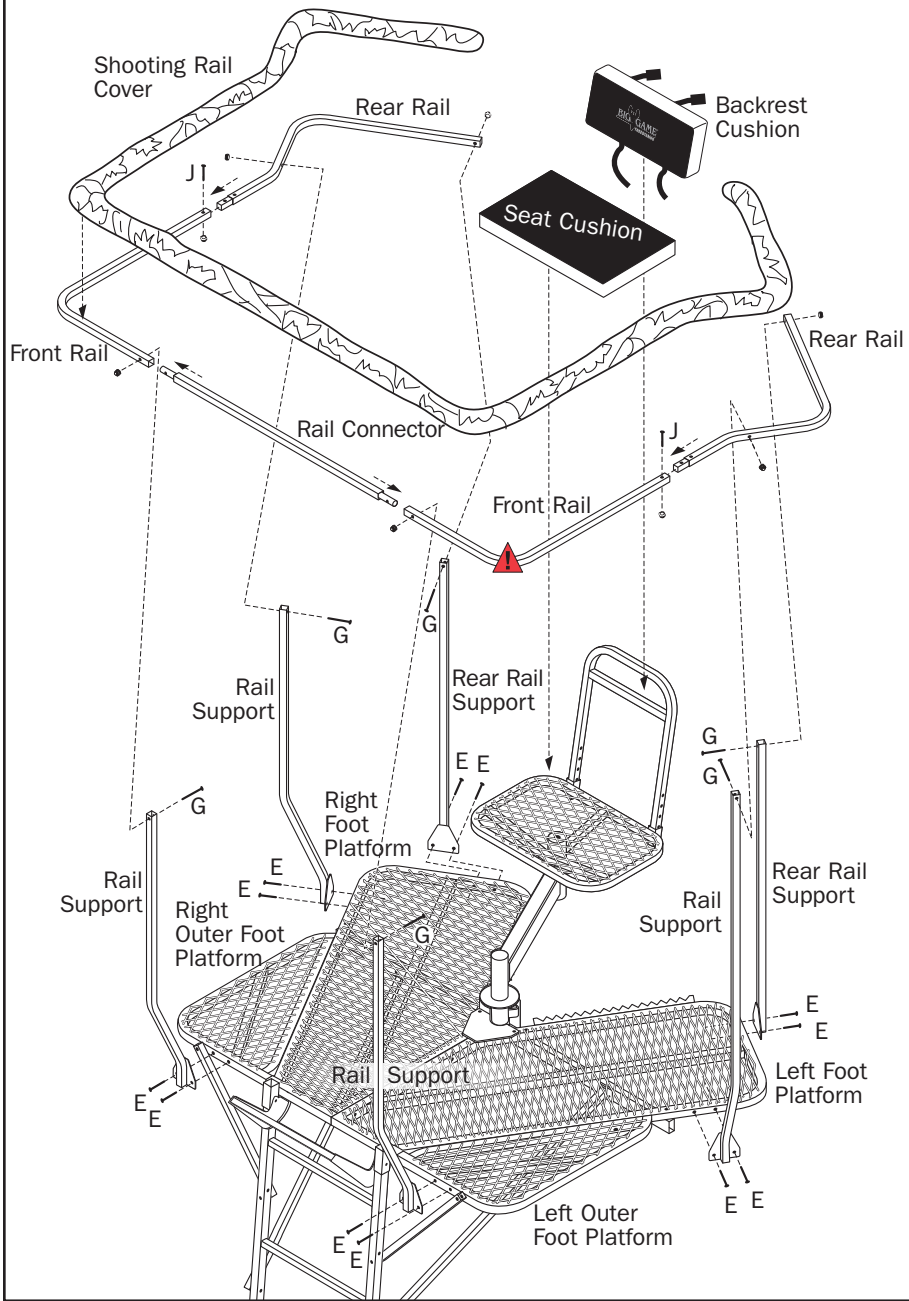

⚠ WARNING! A shooting rail has been provided to serve as a weapon support. This shooting rail is not designed to carry the weight of the user. Under no circumstances should you place your weight on this shooting rest. Failure to follow these instructions may result in serious injury or death!

READ THIS MANUAL IN ITS ENTIRETY PRIOR TO USING THIS PRODUCT.

These warnings apply to all Ladderstands (Model CR3801-S, CR3806-S, CR3811-S, CR3813-S, CR3901-S, CR4055-S, CR4105-S, CR4106-S, CR4200-S, CR4250-S, CR4301-S, CR4500-S, CR4601-S, CR4801-S, CR4850-S, CR5005-S, CR5020-S); Prior to using this stand you must also read and follow all Safety Warnings from pages 4-17 of this manual.

ATTENTION!!
WHEN YOU SEE A "⚠ WARNING!" BE SURE TO HEED THE MESSAGE!
THE INFORMATION CONTAINED IN THESE MESSAGES
CAN SAVE YOUR LIFE!!

- ⚠ WARNING!** You must wear the factory provided full-body fall arrest harness included with this product at all times during use of this product. Failure to follow these instructions may result in serious injury or death!
- ⚠ WARNING!** Never climb, install or use a treestand with a single safety belt or chest harness. These devices have been deemed unsafe for use in climbing apparatus applications and may endanger your personal safety. Use only the factory provided full-body fall arrest harness which meets TMA standards or a similar TMA certified harness. Failure to follow these instructions may result in serious injury or death!
- ⚠ WARNING! DO NOT** use this, or any other product(s) to climb utility poles, telephone poles, structural columns or any other man-made structures. Never use this or any other product(s) around power generation (transformers, generators, substations, etc.) and/or power transmission equipment (power lines). Failure to follow these instructions may result in serious injury or death!
- ⚠ WARNING!** Do not use this or any other product(s) if you have a history of heart problems, back problems, impaired vision, equilibrium problems, high blood pressure or any other physical impairment that may limit your ability to use and/or operate this product(s) in the safe manner outlined in this Instruction Manual. Additionally, do not use this or any other product(s) if you are currently taking any medication and/or substance, including alcohol, that may limit your ability to use this product(s) as outlined and described in this Instruction Manual. Failure to follow these instructions may result in serious injury or death!
- ⚠ WARNING!** Do not attempt to use this or any other product(s) when thunderstorms are threatening and/or present within five (5) miles. Do not attempt to use this or any other product(s) when any other adverse weather condition presents itself. These include weather conditions which have the potential for producing winds, lightning, rain, snow, sleet and/or any other atmospheric condition which may limit the user's ability to operate this product(s) in a safe manner as described in this Instruction Manual. Failure to follow these instructions may result in serious injury or death!
- ⚠ WARNING!** This product(s) is designed for adult use only! No one under the age of 16 should attempt to use this or any other product(s) without direct adult supervision. Failure to follow these instructions may result in serious injury or death!
- ⚠ WARNING!** Do not attempt to use this and/or any other product(s) when ice, snow and/or freezing rain has deposited or formed on any portion of the tree you intend to climb. Failure to follow these instructions may result in serious injury or death!

This Instruction Manual complies with the Treestand Manufacturers Association's
TMS 04 - Standard Practice for Treestand Instructions & TMS 02 - Standard Test Method for Treestand Fall Arrest Systems

⚠ WARNING! Never attempt to either climb up or climb down with a weapon in your possession. **ALWAYS** unload your weapon and pull it up to hunting height using a tether or pull-up rope. **ALWAYS** lower your unloaded weapon down to the ground prior to attempting to climb down. Failure to follow these instructions may result in serious injury or death!

⚠ WARNING! Never attempt to hunt from an unlevel treestand. Additionally, never attempt to level your treestand at heights above the ground. If you find that your treestand is unlevel, canted, angled awkwardly upward or downward, or in any configuration other than level, immediately climb down to ground-level and readjust your treestand as necessary to alleviate this awkward angle. Failure to follow these instructions may result in serious injury or death!

⚠ WARNING! Thoroughly inspect this or any other product(s) prior to each use for signs of wear, rot, corrosion, cracks, deterioration and/or any other type of defect. Protect this product from extended exposure to direct sunlight, excessive heat or freezing temperatures. Do not use this or any other product(s) if it shows evidence of wear, rot, corrosion, cracks, deterioration and/or any other type of defect. Failure to follow these instructions may result in serious injury or death!

We are very serious about your personal safety. A full-body fall arrest harness has been included with this product for your use. The full-body fall arrest harness has been designed to keep you from experiencing a fall.

READ THE FULL-BODY FALL ARREST HARNESS MANUAL CAREFULLY AND FOLLOW ALL OF THE INSTRUCTIONS! YOUR NEW FULL-BODY FALL ARREST HARNESS IS DESIGNED FOR A MAXIMUM CAPACITY (USER AND EQUIPMENT) OF 300 POUNDS (136 KG). ADDITIONALLY - YOUR NEW FULL-BODY FALL ARREST HARNESS MUST BE REPLACED AFTER THREE (3) YEARS OF SERVICE! PLEASE CONTACT US FOR FULL-BODY FALL ARREST HARNESS REPLACEMENT PROCEDURE SHOULD YOU EXPERIENCE A FALL OR SHOULD IT EXCEED THE THREE (3) YEAR SERVICE PERIOD.

⚠ WARNING! Prior to attempting to use this or any other product(s) you must take a moment and become familiar with its assembly, setup and installation. You must practice installing, setting-up and using this product(s) at ground-level prior to attempting to use it at heights above ground-level. Once you have become thoroughly knowledgeable and comfortable with this product(s) setup, installation and use at ground-level, you are now ready to use it at heights above ground-level. Failure to follow these instructions may result in serious injury or death!

⚠ WARNING! This ladderstand was designed to be used on trees with a **MINIMUM DIAMETER OF 9-INCHES. DO NOT** use on trees with smaller diameters. Failure to follow this warning may result in serious injury or death!

⚠ WARNING! Never install, set-up, or climb to your ladderstand with a weapon. Use a pull up rope to carefully raise your unloaded weapon after full-body fall arrest harness is secure and you are set in the stand.

To activate your product's warranty, a registration card can be found on page 103 and must be completed and returned to the manufacturer within 30 days of purchase. Be sure to keep a copy of this for your records

This Instruction Manual complies with the Treestand Manufacturers Association's TMS 04-Standard Practice for Treestand Instructions & TMS 02-Standard Test Method for Treestand Fall Arrest Systems

READ THIS MANUAL IN ITS ENTIRETY PRIOR TO USING THIS PRODUCT.

FIELD INSTALLATION - LADDERSTANDS

STEP 1. Select a healthy and straight tree. Remove all dead branches or limbs that will be in the way prior to setting up this ladderstand.

STEP 2. Assemble ladder sections to the main section. **NOTE:** All ladder sections will be assembled with the narrow section facing upward and all larger ends (sleeves) facing downward. (fig. 1) After assembling the ladder, insert snap pins in every joint to secure.

NOTE: If your ladder has Safety Sleeves (CR4850-S) please refer to page 94.

STEP 3. Attach the (2) stabilizer straps to each side of the rear frame support (near the bark biters). Secure straps by wrapping strap around rear frame support and pulling through its looped end. (fig. 2) Then, firmly tie straps to a lower-level ladder rung.

NOTE: Do not attempt to install your ladderstand without the straps firmly tied to the ladder.

STEP 4. Place the ladderstand flat on the ground in front of the tree with the bottom ladder section approximately 2 feet away from the base of the trunk. Then with at least 3 adults, gently raise the ladderstand to a vertical position allowing the bark biters to come into direct contact with the tree. (fig. 3) Once elevated completely, carefully pull the base away from the tree until the sitting & standing platforms are parallel to the ground. (fig. 4)

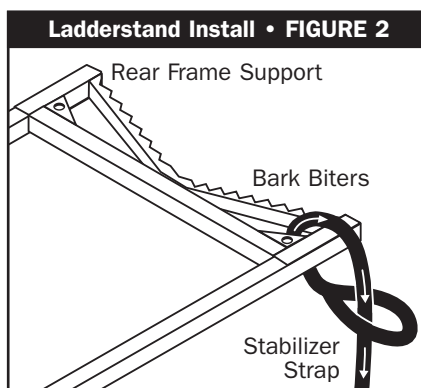
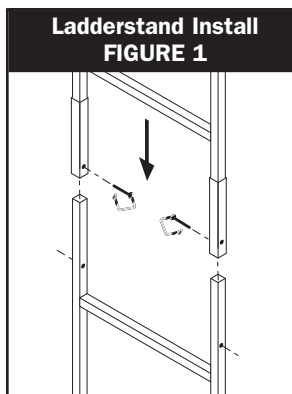

⚠ WARNING! You must have three (3) adults to install or remove your stand from the tree. Failure to follow these instructions may result in serious injury or death!

STEP 5. Attach the adjustable support bar to the ladderstand. **NOTE:** The adjustable support bar for CR4200-S and CR4850-S should be attached to the highest ladder rung that is reachable from the ground. The other support bars should be attached to receivers on the middle ladder section. Adjust the length so that the tree piece fits snugly to the tree, providing rigid support to the ladder; insert snap pin or bolt cap to secure. Once you have set the adjustable support bar, use the rope to secure it to the tree. (See pages 94-95). **NOTE:** No support bar is included or required for CR5020-S

STEP 6. When the ladderstand is level and the adjustable support bar is secure, untie the stabilizer straps from the ladder section. Crisscross stabilizer straps behind the tree trunk pulling them snug. Then, secure each stabilizer strap by tying several firm knots around a middle section ladder rung. **NOTE:** Tie the stabilizer straps as high as you can reach while standing safely on the ground. (fig. 5)

This Instruction Manual complies with the Treestand Manufacturers Association's
TMS 04 - Standard Practice for Treestand Instructions & TMS 02 - Standard Test Method for Treestand Fall Arrest Systems

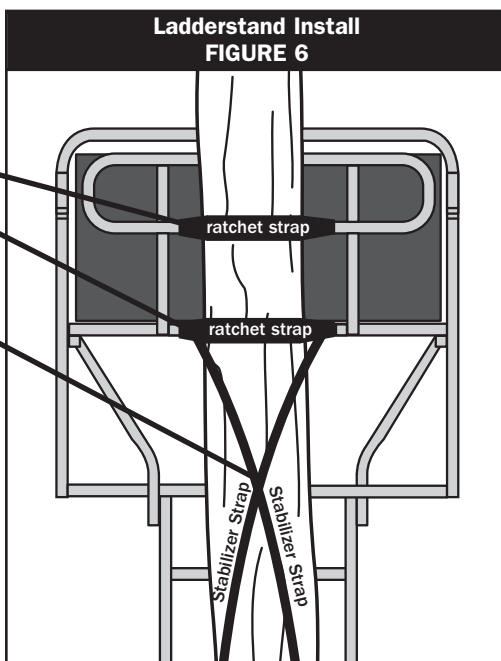
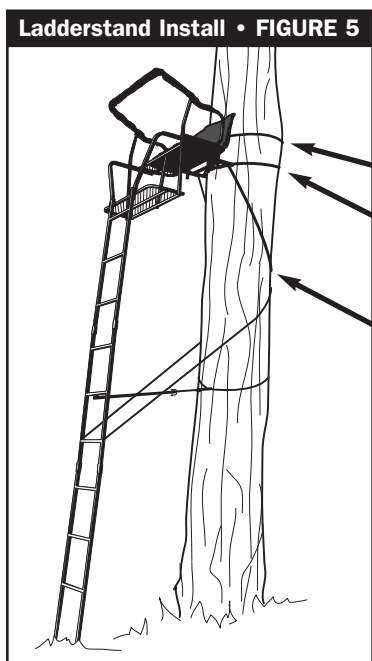
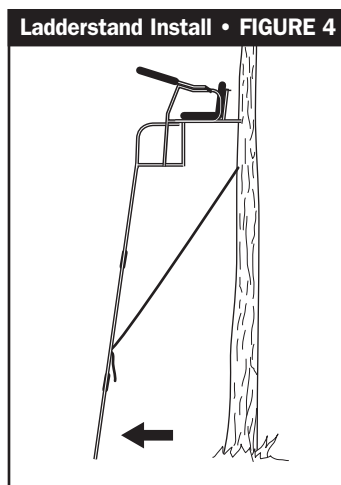
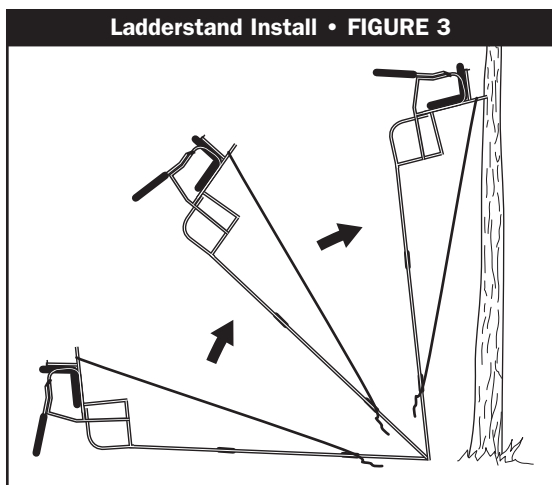

Note: Some models require 2 ratchet straps.

⚠ WARNING! The two (2) stabilizer straps must be attached and tightened prior to climbing to attach the platform(s) ratchet strap(s). Additionally, the adjustable support bar(s) and the adjustable support bar(s) rope must be installed (where included) prior to climbing to install the platform(s) ratchet(s). Failure to follow these instructions may result in serious injury or death!

This Instruction Manual complies with the Treestand Manufacturers Association's
TMS 04-Standard Practice for Treestand Instructions & TMS 02-Standard Test Method for Treestand Fall Arrest Systems

READ THIS MANUAL IN ITS ENTIRETY PRIOR TO USING THIS PRODUCT.

⚠ WARNING! Prior to climbing, make sure that all the ladders sections are firmly connected with the proper hardware in place. Make sure none of the sections have become separated. If they are, do not climb the ladder. With the help of two other adults, lower the stand back down to the ground and reattach the ladder rungs and reinstall the hardware in the manner previously described. Failure to follow these instructions may result in serious injury or death!

⚠ WARNING! Prior to attempting to climb a ladder stand for the first time, make certain the feet of the bottom rung ladder section are firmly planted on solid, level ground. If they are not firmly planted on level ground, **DO NOT** climb the ladder. With the help of two (2) other adults, lower the stand and find a suitable location to safely install the ladder stand. Failure to follow these instructions may result in serious injury or death!

⚠ WARNING! Before attempting to climb the ladderstand, bounce on the bottom ladder section to set the ladder into the ground before proceeding higher. Failure to follow this warning may result in serious injury or death!

⚠ WARNING! Always lean forward while climbing and securely attach your full-body fall arrest harness tree belt to the tree prior to securing the platform to the tree and stepping onto the platform. Failure to follow this warning may result in serious injury or death!

STEP 7. CRITICAL STEP! After installing the adjustable support bar and stabilizer straps, it is now time to attach the **RATCHET STRAP(S)** to the top section of your ladderstand. Ratchets are attached at the contact point from the stand to the tree. Hook one end of the ratchet onto the rear frame support, near the bark biters, wrap around tree trunk, and connect to opposite side. Carefully tighten the **VITAL RATCHET STRAP** securely. (see fig. 6, page 90) **NOTE: TWO (2) VITAL RATCHET STRAPS ARE INCLUDED AND NECESSARY FOR SOME MODELS. ALWAYS USE ALL PARTS REQUIRED.**

⚠ WARNING! When climbing to secure the ratchet strap(s) on the platform(s), it is important to lean forward when climbing to keep the stand centered and secure to the tree trunk. **DO NOT** lean backwards when climbing. Failure to follow these instructions may result in serious injury or death!

⚠ WARNING! When climbing, always maintain three points of contact as you ascend (climb up) and while descending (climb down). Failure to maintain three points of contact puts the user at serious risk of bodily injury. Failure to follow these instructions may result in serious injury or death!

⚠ WARNING! The platform ratchet strap(s), stabilizer straps and adjustable support bar(s) have all been included with your new ladderstand to ensure its solid attachment to the tree. All three of these safety devices must be installed as outlined in this Instruction Manual. Failure to install these safety devices as outlined in this Instruction Manual may result in serious injury or death! **NOTE:** No support bar is included or required for CR5020-S.

STEP 8. You are now ready to use your ladderstand!

⚠ WARNING! This product(s) is designed for adult use only! No one under the age of 16 should attempt to use this or any other product(s) without direct adult supervision. Failure to follow these instructions may result in serious injury or death!

This Instruction Manual complies with the Treestand Manufacturers Association's
TMS 04 - Standard Practice for Treestand Instructions & TMS 02 - Standard Test Method for Treestand Fall Arrest Systems

VITAL RATCHET INSTRUCTIONS

STEP 1. Thread strap through slot in the center of the ratchet reel. (see fig. 1) Remove slack from strap by pulling loose end as tightly as possible. (see fig. 2)

STEP 2. Then ratchet handle back and forth to tighten straps, a minimum of two (2) wraps around the ratchet reel is required. (see fig. 3)

STEP 3. After strap is tight, close handle to the lock position.

STEP 4. To remove tension, pull spring loaded retaining lock and open ratchet completely, then manually pull strap to loosen. (see fig. 4)

RATCHET • FIGURE 1

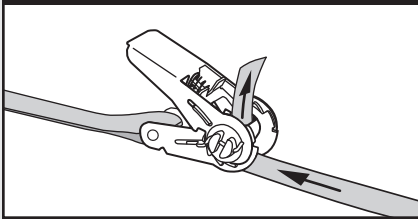

RATCHET • FIGURE 2

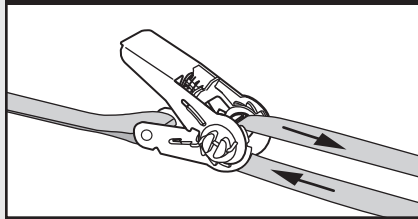

RATCHET • FIGURE 3

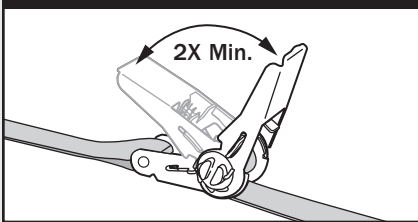

RATCHET • FIGURE 4

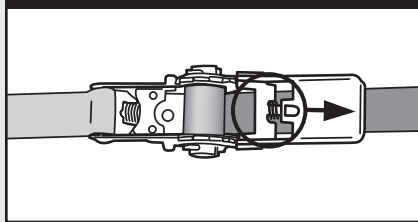

OPTIONAL ACCESSORIES AND REPLACEMENT PARTS

Any number of innovative accessories are available and sold separately to compliment your new climbing system. Only genuine authorized accessories should be used with your climbing system. Genuine replacement parts are also available online or via telephone. Should you require parts or service, or if you just have a question about this, or any other product(s), simply give one of our customer service representatives a call toll-free at 800-268-5077 or visit www.BigGameTreestands.com

STORAGE AND CARE OF YOUR STAND

Your new treestand is factory finished with a state-of-the-art powder coating that guarantees years of trouble-free service. It is recommended that you store your treestand out of direct sunlight and out of any other harsh environmental condition(s) that may adversely affect its performance.

This Instruction Manual complies with the Treestand Manufacturers Association's TMS 04-Standard Practice for Treestand Instructions & TMS 02-Standard Test Method for Treestand Fall Arrest Systems

READ THIS MANUAL IN ITS ENTIRETY PRIOR TO USING THIS PRODUCT.

ADJUSTABLE SUPPORT BARS

- STEP 1.** Assemble adjustable support bars by sliding **Part A** into the **Part B**.
NOTE: The **snap pin** will be used to set the desired length of the adjustable support bars.
STEP 2. Attach support bar to ladder using remaining bolts and wing nuts.
NOTE: These figures relate to Step 5 of the Installation Instructions from page 90.

ADJUSTABLE SUPPORT BAR ASSEMBLY FOR CR4850-S

The diagram illustrates two main assembly steps. The top part shows 'CONNECTING LADDER SECTIONS WITH SAFETY SLEEVES', where a 'Safety Sleeve' is placed over the top of a 'Ladder Section', and a 'Middle Ladder Section' is inserted into it. A 'Snap Pin' is then used to secure the connection through pre-drilled holes in the sleeve and sections. The bottom part shows 'ADJUSTABLE SUPPORT BAR' assembly, where an 'Adjustable Support Bar Ladder Piece' is attached to a 'Ladder Section' using an 'Adjustable Bolt Cap' and a nut. The 'Adjustable Support Bar Tree Piece' is also shown as part of the assembly.

CONNECTING LADDER SECTIONS WITH SAFETY SLEEVES

STEP 1. Place the **Safety Sleeve** over the top of the **middle ladder section**.

STEP 2. Insert the **Middle Ladder section** into the **Top Ladder Section** so that the **Safety Sleeve** is on the outside of both ladder pieces.

STEP 3. Insert the **Snap Pin** through the predrilled holes of the **Safety Sleeves, Top Ladder Section** and **Middle Ladder Section** to connect all pieces together. **NOTE:** Be sure that the predrilled hole of the **Safety Sleeve** is assembled to the top of the assembly.

ADJUSTABLE SUPPORT BAR

STEP 1. Assemble adjustable support bar by sliding **tree piece** into the **ladder piece**. **NOTE:** The **adjustable bolt cap** will be used to set the desired length of the **adjustable support bar**.

STEP 2. Attach **adjustable support bar** to ladder using remaining bolts and wing nuts.

NOTE: These figures relate to Step 5 of the Installation Instructions from page 90.

This Instruction Manual complies with the Treestand Manufacturers Association's
TMS 04 - Standard Practice for Treestand Instructions & TMS 02 - Standard Test Method for Treestand Fall Arrest Systems

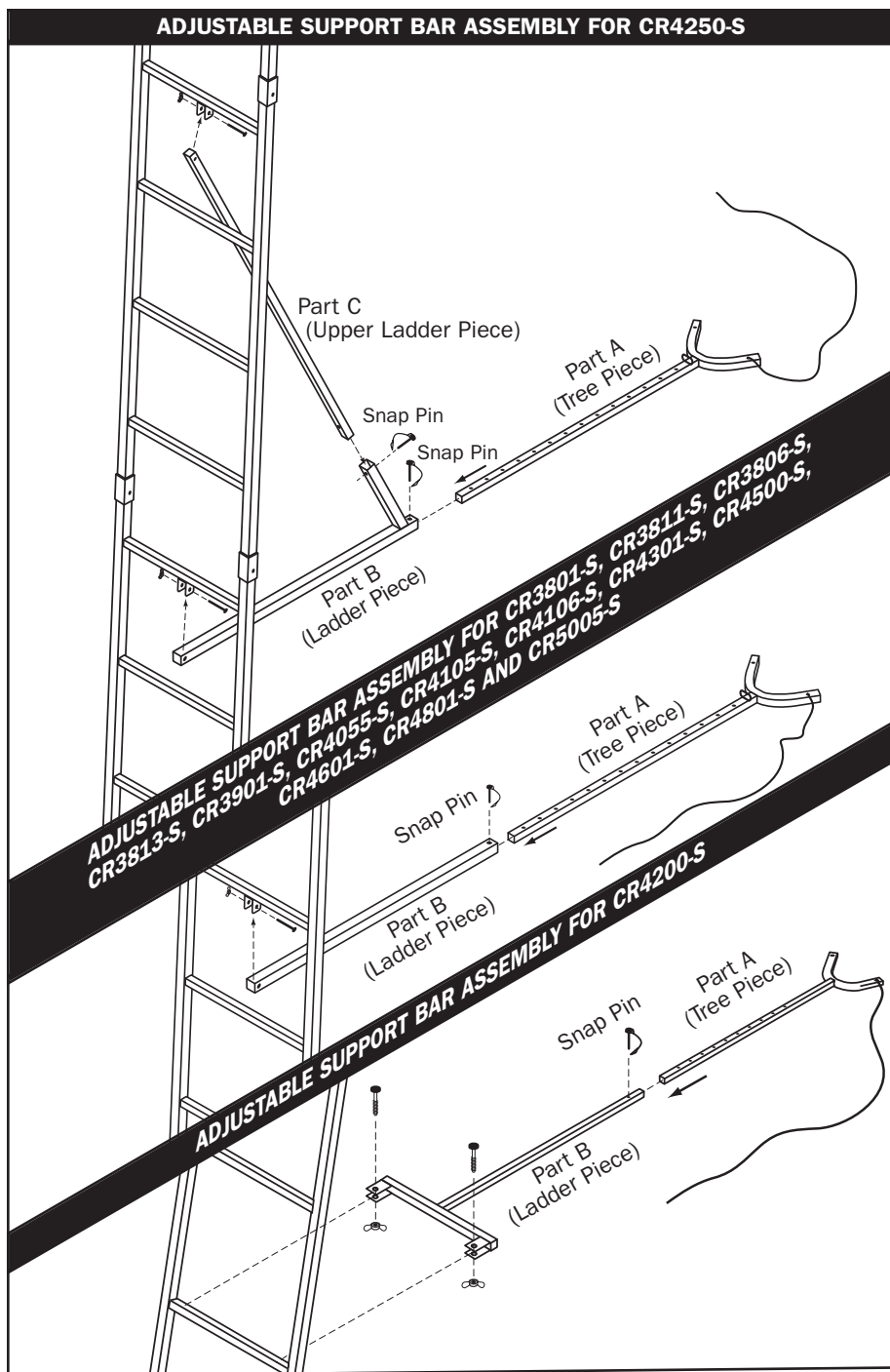

This Instruction Manual complies with the Treestand Manufacturers Association's
TMS 04-Standard Practice for Treestand Instructions & TMS 02-Standard Test Method for Treestand Fall Arrest Systems

READ THIS MANUAL IN ITS ENTIRETY PRIOR TO USING THIS PRODUCT.

STANDARD LIMITED WARRANTY

Warranty: BGHA, Inc. warrants all Big Game® Hunting Accessories treestands or climbing system products to be free from defects in material and workmanship for a period of twelve months from the original date of retail purchase. BGHA, Inc. warrants the enclosed hardware (where applicable) is delivered to be free from physical defects for a period of twelve months from the original date of retail purchase.

Repair Procedures, Exclusive Remedy: BGHA, Inc. will at its option, repair, or replace products not conforming to this limited warranty at no charge. THIS IS THE SOLE AND EXCLUSIVE REMEDY AVAILABLE FOR BREACH OF WARRANTY OR UNDER ANY OTHER LEGAL THEORY WITH RESPECT TO BIG GAME HUNTING ACCESSORIES PRODUCTS. If you find a product to be defective, contact the customer service department at 1(800) 268-5077. When you receive authorization, return the product as directed at your expense. Product repairs not covered by warranty, and product updates, will be provided at a set rate.

Limitations: This warranty is void if the product is damaged by improper or abnormal use or by accident; if the product is altered or modified in any way other than those directed by official Big Game® Hunting Accessories instructions; or if any attempt is made to repair the product without authorization from BGHA, Inc. It is solely the purchaser's responsibility to determine the suitability of these products for each particular application. Big Game® Hunting Accessories products are intended for hunting and hunting only. Big Game® Hunting Accessories are in all events not suitable, and are not authorized, for use in any situations that might pose potentially injurious to life and health, other than those situations that the products are intended for. This warranty is not assignable or transferable.

No Other Warranties: EXCEPT AS PROVIDED IN THIS LIMITED WARRANTY SET FORTH IN THE WARRANTY CARD SUPPLIED WITH BIG GAME HUNTING ACCESSORIES AND INSTRUCTION SHEETS ARE PROVIDED "AS IS". ALL OTHER WARRANTIES AND REPRESENTATIONS, ORAL OR WRITTEN, EXPRESSED OR IMPLIED, INCLUDING BUT NOT LIMITED TO ANY IMPLIED WARRANTIES OF MERCHANTABILITY OR FITNESS FOR A PARTICULAR PURPOSE, ARE EXCLUDED AND DO NOT APPLY. THERE ARE NO WARRANTIES WHICH EXTEND BEYOND THE DESCRIPTION ON THE FACE HERE OF. Except as required by law, no representative, agent or employee of BGHA, Inc. is authorized to make warranties, representations, or obligations inconsistent with or in addition to those set forth in this limited warranty.

No Damages: IN NO EVENT WILL BGHA, INC. BE LIABLE FOR DIRECT, INDIRECT, SPECIAL, INCIDENTAL, OR CONSEQUENTIAL DAMAGES RESULTING FROM BREACH OF WARRANTY OR UNDER ANY OTHER LEGAL THEORY, even if advised of the possibility of such damages. In no event will BGHA, Inc. be liable for sums in excess of the purchase price of the product. BGHA, Inc is thus not liable for lost profits or goodwill; downtime; damage or destruction of items or equipment used with, or in conjunction with, BGHA, Inc.; personal injury or loss; or any other damages.

General: (a) This agreement is the entire agreement between you and BGHA, Inc.; supercedes any prior or different agreements, representations, or proposals; and may be changed only by written agreement with BGHA, Inc. (b) Waiver by any party of any default or breach of this agreement will not constitute a waiver of any subsequent default or breach of the same of different kind. (c) The invalidity of any provision of this agreement shall not affect the validity of the other provisions hereof. (d) This agreement shall be governed by the laws of the State of Minnesota, U.S.A.

This Instruction Manual complies with the Treestand Manufacturers Association's
TMS 04 - Standard Practice for Treestand Instructions & TMS 02 - Standard Test Method for Treestand Fall Arrest Systems

To activate your product's warranty, please mail in your registration card or submit it online at www.biggametrestands.com

PRODUCT REGISTRATION

Product Purchased _____ Model Number _____

Serial Number _____

Owner's Name _____

Street Address _____

City _____ State _____ Zip Code _____

Email Address _____ Phone _____

Owners Age (optional) _____ Sex (optional) M F

Date Purchased _____

Purchased From (Dealer Name) _____

How did you hear about us: Catalog Webpage Friend Magazine

Other, Please Explain _____

Are you a: Bow Hunter Gun Hunter Both

Treestand Preference: Fixed Position Climbing Ladderstand

Will you use the full-body fall arrest harness provided or a different brand?

If different, which brand & model? _____

REGISTRATION INFORMATION

Although Big Game® Treestands are manufactured with the highest standards, regular maintenance is required for the up-keep of your product. Regular maintenance is the responsibility of the consumer; we recommend that you replace all strap assemblies and cam-buckle straps for your treestand at least annually, cables at least every two years, and ALL hardware at least every three years. If at anytime there is a defect with any part of your treestand, we insist that you replace the part prior to using the stand. Improper or incorrectly performed maintenance or repair, including the use of unauthorized replacement parts, will void all warranties.

Replacement parts may be ordered on our website at www.biggametrestands.com or by calling our customer service department at 800-268-5077.

OWNER'S RECORD

Product Name _____ Model Number _____

Serial Number _____

Purchased From _____ Purchased Date _____

YOU MUST RETURN THE COMPLETED REGISTRATION CARD ABOVE WITHIN (30) DAYS OF THE PURCHASE IN ORDER TO ACTIVATE THE LIMITED WARRANTY COVERAGE. (Make sure to include date purchased on the card!)

PLEASE REGISTER TO ACTIVATE YOUR PRODUCT'S WARRANTY

103