

848L0B93A2 (704)



GB



OWNER'S MANUAL

BLOWERS

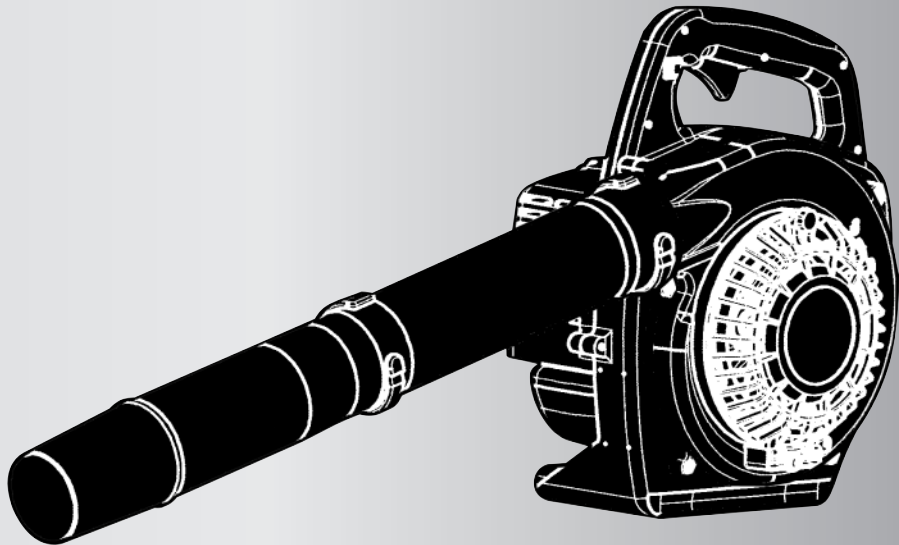

HB2302
HBZ2601

EC DECLARATION OF CONFORMITY

We, ZENOAH CO., LTD
1-9, Minamidai, Kawagoe, Saitama, Japan

declare in sole responsibility that the following products referred to
 in this declaration conform with

DIRECTIVE 98/37/EC

2000/14/EC Internal control production.

The products referred to are:

DESIGNATION : BLOWERS

MODELS : HB2302 HBZ2601

SERIAL NUMBERS : 40600101 and up

The company named above will keep on file the following technical
 documentation for any inspection purpose.

- Operation instructions
- Plans and Drawings
- Description of measures designed to ensure conformity
- Other technical documentation : Specification sheet
Inspection standard

Saitama, Japan 1st April 2007

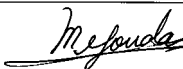



Masahiko GOUDA
 General Manager, Quality Assurance Department

EXPLANATION OF SYMBOLS AND SAFETY WARNINGS



WARNING!!!
RISK OF DAMAGING HEARING
 Wear head, eye and ear protection.

MODEL		SOUND LEVEL		VIBRATION LEVEL	
		ISO 11094		ON HANDLE	
		LwA		ISO 7916	
		measured	guaranteed	idling	racing
HB2302	22.5cm ³	104dB(A)	106dB(A)	4.7m/s ²	11.1m/s ²
HBZ2601	25.4cm ³	104dB(A)	106dB(A)	4.7m/s ²	11.1m/s ²

APPROVAL NUMBER OF CE EXHAUST EMISSION REGULATION (2002/88/EC)
HB2302 : e13*97/68SH2G3*2002/88*0104*02
HBZ2601 : e13*97/68SH2G3*2002/88*0094*03

▲ SAFETY FIRST

Instructions contained in warnings within this manual marked with a ▲ symbol concern critical points which must be taken into consideration to prevent possible serious bodily injury, and for this reason you are requested to read all such instructions carefully and follow them without fail.

WARNINGS IN THE MANUAL**▲ WARNING**

This mark indicates instructions, which must be followed in order to prevent accidents, which could lead to serious bodily injury or death.

❗ IMPORTANT

This mark indicates instructions, which must be followed, or it leads to mechanical failure, breakdown, or damage.

📖 NOTE

This mark indicates hints or directions useful in the use of the product.

Contents

1. Parts location	3
2. Specifications	4
3. Warning labels on the machine	4
4. Symbols on the machine	4
5. For safe operation	5
6. Set up	8
7. Fuel	9
8. Operation	10
9. Maintenance	11
10. Storage	13
11. Disposal	13
12. Optional vacuum kit usage	14
13. Troubleshooting guide	16

1. Parts location

1. Stop Switch
2. Throttle Lever
3. Air Intake Screen (Air inlet net)
4. Spark Plug Cap
5. Recoil Starter Knob
6. Air Cleaner
7. Fuel Tank
8. Blower Pipe
9. Screw

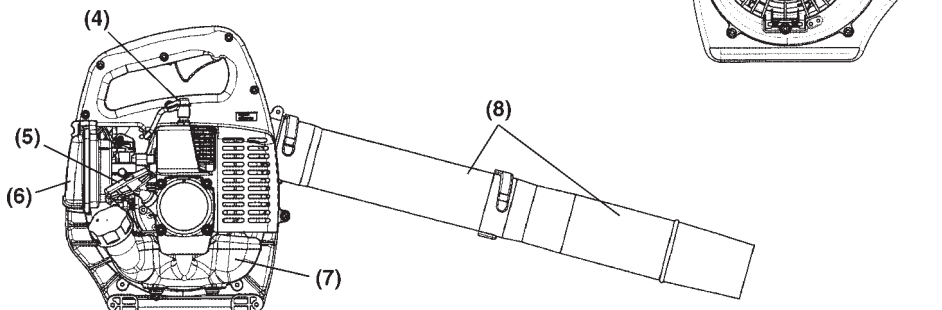

2. Specification

Model		HB2302	HBZ2601
Dimensions (LxWxH)	mm	325 x 230 x 360	327 x 268 x 360
Dry weight (w/o tube and nozzle)	kg	3.7	3.9
Fuel tank capacity	liter	0.75	0.65
Engine Type		Air cooled 2-cycle gasoline engine	
Displacement	cm ³	22.5	25.4
Carburetor		Diaphragm type (Walbro)	
Ignition system		T.C.I.	C.D.I.
Spark plug		Champion RCJ6Y (noise proof)	NGK CMR7A
Muffler		Spark arrester equipped	
Operating Engine Speed	rpm	2300 to 7500	2800 to 7890
Idle speed	rpm	2300	2800
Average Air Volume	cu.m/min.	10	10
Max. Air Velocity	m/sec.	67	70
Noise Level at 50 feet	dB	70	69

Specifications are subject to change without notice.

3. Warning labels on the machine



Read owner's manual before operating this machine.



Wear head, eye and ear protection.



Warning / Attention

Keep all children, bystanders and helpers 15 meters away from the machine.



If warning label peels off or becomes soiled and impossible to read, you should contact the dealer from which you purchased the product to order new labels and affix them in the required location(s).



Never modify your machine.
We won't warrant the machine, if you use the remodeled blower or if you don't observe the proper usage written in the manual.

4. Symbols on the machine

For safe operation and maintenance, symbols are carved in relief on the machine. According to these indications, please be careful not to make a mistake.
 The port to refuel the "MIX GASOLINE"



Position: FUEL TANK CAP



The direction to close the choke
Position: ENGINE COVER



The direction to open the choke
Position: ENGINE COVER

▲ 5. For safe operation



1. Read this manual carefully until you completely understand and follow all safety and operating instructions.
2. Keep this manual handy so that you may refer to it later whenever any questions arise. Also note, if you have any questions which cannot be answered herein, contact the dealer from whom you purchased the product.
3. Always be sure to include this manual when selling, lending, or otherwise transferring the ownership of this product.
4. Do not lend or rent your machine without the owner's manual.
5. Be sure that anyone using your unit understands the information contained in this manual.
6. Never let a child under 13 years old use the machine.



WORKING CONDITION

1. Refrain from operating the blower if you are tired, ill, or upset, or if you are under the influence of alcohol, drugs or medication.
2. To reduce the risk of hearing loss associated with sound level(s), hearing protection is required.
3. To reduce the risk of injury associated with thrown objects, always wear eye protection and foot protection. Eye protection should meet the requirements of ANSI Z87.1.
4. To reduce the risk of injury associated with the inhalation of dust, use a face filter mask in dusty conditions.
5. Wear rubber-soled shoes or shoes with some other form of anti-slip protection to help protect you against falling.
6. To reduce the risk of injury associated with objects being drawn into rotating parts, do not wear loose clothing, scarves, neck chains, unconfined long hair, and the like.
7. Prolonged use of a blower, exposing the operator to vibrations and cold may produce whitefinger disease (Raynaud's phenomenon), which symptoms are tingling and burning sensa-



tions followed by loss of color and numbness in the fingers. All factors which contribute to whitefinger disease are not known, but cold weather, smoking diseases or physical conditions as well as long periods of exposure to vibration are mentioned as factors. In order to reduce the risk of whitefinger disease, the following precautions are strongly recommended;

- a) Keep your body warm. Never use blower during rains.
 - b) Wear thick anti-vibration gloves.
 - c) Take more than 5 minutes of break in warm place frequently.
 - d) Maintain a firm grip at all times, but do not squeeze the handles with constant, excessive pressures.
 - e) If you feel discomfort, redness and swelling of your fingers or any other part of your body, see a doctor before getting worse.
8. The ignition system of your unit produces an electromagnetic field of a very low intensity. This field may interfere with some pacemakers. To reduce the risk of serious or fatal injury, persons with pacemaker should consult their physician and the pacemaker manufacturer before operating this tool.

WORKING CIRCUMSTANCE

1. To reduce the risk of injury associated with exhaust fume inhalation, do not operate in unventilated area. The exhaust gases contain harmful carbon monoxide.
2. Avoid using the blower where stable footing and balance are not assured.



AVOID NOISE PROBLEM

NOTE

- Check and follow the local regulations as to sound level and hours of operations for blower.

▲ 5. For safe operation

1. Operate power equipment only at reasonable hours-not early in the morning or late at night when people might be disturbed. Comply with times listed in local ordinances.
2. To reduce sound levels, limit the number of pieces of equipment used at any one time.
3. Operate power blowers at the lowest possible throttle speed to do the job.
4. Check your equipment before operation, especially the muffler, air intakes and air filters.

WORKING PLAN

- When planning your work schedule, allow plenty of time to rest. Limit the amount of time over which the product is to be used continuously to somewhere around 30 ~ 40 minutes per session, and take 10 ~ 20 minutes of rest between work sessions. Also try to keep the total amount of work performed in a single day under 2 hours or less.



FUEL

▲ WARNING

To reduce the risk of fire and burn injury:

- a) Handle fuel with care. It is highly flammable.
- b) Do not smoke while handling fuel.
- c) Do not refuel a hot engine.
- d) Do not refuel a running engine.
- e) Avoid spilling fuel or oil. Always wipe unit dry before using.
- f) Move at least 10 ft. (3 meters) away from the fueling point before starting engine.
- g) Always store gasoline in a container approved for flammable liquids.
- h) Make sure the unit is properly assembled and in good operating condition.

BEFORE STARTING THE ENGINE

- Each time before starting the engine, inspect the entire unit to see if every part is in good order and is securely tightened in place. If

any damage is found in the fuel line, the exhaust line, or the ignition wiring, do not use the blower until it has been repaired.

❗ IMPORTANT

- Before starting operation, always make sure to check if any obstacles are left inside the volute case. The obstacles may cause damage on fan and volute case and serious injury.

▲ WARNING

- Never use the blower without the screen at the air intake of the blower. Before each use, check that, the screw (1) is securely tightened and is free from any damage.
- Never remove debris from the intake screen while the engine is running. Contact with rotating blower fan may result in a serious personal injury.

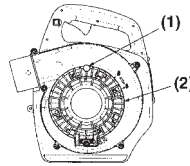

- (1) Screw
(2) Air intake screen (Air inlet net)

▲ WARNING

- To reduce the risk of injury associated with contacting rotating parts, stop the engine before installing or removing attachments. Do not operate without net in place. Always disconnect the spark plug before performing maintenance or accessing movable parts.



USING THE PRODUCT

1. Check the work area that the blower will be used in and remove or cover all valuables that may be damaged by the air blast or thrown debris.
2. To reduce the risk of injury associated with thrown objects.



- a) Watch out for children, pets, open windows or freshly washed cars, and blow debris safely away.
- b) Use the full blower nozzle extension so the air stream can work close to the ground.

▲ 5. For safe operation

- c) Do not allow bystanders in work area.
- d) Do not point the blower nozzle in the direction of people or pets.
- e) Always check to be sure that no debris has been blown onto someone else's property.
- f) Pay attention to the direction of the wind, do not work against the wind.

3. To minimize blowing time.

- a) Use rakes and brooms to loosen debris before blowing.
- b) In dusty conditions, slightly dampen surfaces or use mister attachment when water is available.
- c) Conserve water by using power blowers instead of hoses for many lawn and garden applications, including areas such as gutters, screens, patios, grills, porches and gardens.



4. Never to touch the spark plug or plug cord while the engine is in operation. Doing so may result in being subjected to an electrical shock.
5. Never to touch the muffler, spark plug, or other metallic parts of the engine while the engine is in operation or immediately after shutting down the engine. These metallic parts reach high temperatures during operation and doing so could result in serious burns.
6. After using blowers and other equipment, CLEAN UP! Dispose of debris in trash receptacles.



MAINTENANCE

1. In order to maintain your product in proper working order, perform the maintenance and checking operations described in the manual at regular intervals.
2. Always be sure to turn off the engine and disconnect the spark plug before performing any maintenance or checking procedures.

▲ WARNING

- The metallic parts reach high temperatures immediately after stopping the engine.

3. Examine the blower at intervals for loose fasteners and rusted or damaged parts. Use special care around the fuel line, the muffler, and the ignition wiring.
4. All engine service except for those described in this manual should be performed by competent service personnel. Improper service to the blower fan and muffler could cause a hazardous failure.
5. When replacing the any other part, or any lubricant, always be sure to use only Zenoah products or products which have been certified by Zenoah for use with the Zenoah product.
6. In the event that any part must be replaced or any maintenance or repair work not described in this manual must be performed, please contact a representative from the store nearest Zenoah authorized servicing dealer for assistance.
7. Do not use any accessory or attachment other than those bearing the Zenoah mark and recommended for the unit.
8. Under no circumstances should you ever take apart the product or alter it in any way. Doing so might result in the product becoming damaged during operation or the product becoming unable to operate properly.

TRANSPORTATION

- Drain the fuel from the fuel tank before transporting or storing the blower.

STORAGE

- When storing the blower, choose a space indoors free from moisture and out of the reach of children.

6. Set up

BLOWER PIPE

- Align groove in blower pipe with projection on blower housing (or another blower pipe) and slide the pipe onto the blower housing (or another blower pipe). Rotate the pipe clockwise to lock it into place.

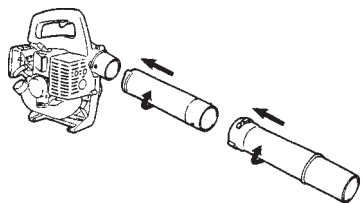

7. Fuel

■ FUEL

⚠ WARNING

- **Gasoline is very flammable. Avoid smoking or bringing any flame or sparks near fuel. Make sure to stop the engine and allow it cool before refueling the unit. Select outdoor bare ground for fueling and move at least 3 m (10 ft) away from the fueling point before starting the engine.**



- The Zenoah engines are lubricated by oil specially formulated for air-cooled 2-cycle gasoline engine use. If Zenoah oil is not available, use an anti-oxidant added quality oil expressly labeled for air-cooled 2-cycle engine use (JASO FC GRADE OIL or ISO EGC GRADE).
- Do not use BIA or TCW (2-stroke water-cooling type) mixed oil.



■ RECOMMENDED MIXING RATIO GASOLINE 50 : OIL 1

(when using ZENOAH genuine oil)

- **Exhaust emission are controlled by the fundamental engine parameters and components (eq., carburation, ignition timing and port timing) without addition of any major hardware or the introduction of an inert material during combustion.**
- These engines are certified to operate on unleaded gasoline.
- Make sure to use gasoline with a minimum octane number of 89RON (USA/Canada: 87AL).
- If you use a gasoline of a lower octane value than prescribed, there is a danger that the engine temperature may rise and an engine problem such as piston seizing may consequently occur.
- Unleaded gasoline is recommended to reduce the contamination of the air for the sake of your health and the environment.
- Poor quality gasolines or oils may damage sealing rings, fuel lines or fuel tank of the engine.

■ HOW TO MIX FUEL

⚠ WARNING

- Pay attention to agitation.

1. Measure out the quantities of gasoline and oil to be mixed.
2. Put some of the gasoline into a clean, approved fuel container.

3. Pour in all of the oil and agitate well.
4. Pour in the rest of gasoline and agitate again for at least one minute. As some oils may be difficult to agitate depending on oil ingredients, sufficient agitation is necessary for the engine to last long. Be careful that, if the agitation is insufficient, there is an increased danger of early piston seizing due to abnormally lean mixture.
5. Put a clear indication on the outside of the container to avoid mixing up with gasoline or other containers.
6. Indicate the contents on outside of container for easy identification.

■ FUELING THE UNIT

1. Untwist and remove the fuel cap. Rest the cap on a dustless place.
2. Put fuel into the fuel tank to 80% of the full capacity.
3. Fasten the fuel cap securely and wipe up any fuel spillage around the unit.

⚠ WARNING

1. Select bare ground for fueling.
2. Move at least 10 feet (3 meters) away from the fueling point before starting the engine.
3. Stop the engine before refueling the unit. At that time, be sure to sufficiently agitate the mixed gasoline in the container.

■ FOR YOUR ENGINE LIFE, AVOID:

1. **FUEL WITH NO OIL (RAW GASOLINE)** – It will cause severe damage to the internal engine parts very quickly.
2. **GASOHOL** – It can cause deterioration of rubber and/or plastic parts and disruption of engine lubrication.
3. **OIL FOR 4-CYCLE ENGINE USE** – It can cause spark plug fouling, exhaust port blocking, or piston ring sticking.
4. **Mixed fuels which have been left unused for a period of one month or more** may clog the carburetor and result in the engine failing to operate properly.
5. In the case of storing the product for a long period of time, clean the fuel tank after rendering it empty. Next, activate the engine and empty the carburetor of the composite fuel.
6. In the case of scrapping the used mixed oil container, scrap it only at an authorized repository site.

📖 NOTE

- As for details of quality assurance, read the description in the section Limited Warranty carefully. Moreover, normal wear and change in product with no functional influence are not covered by the warranty. Also, be careful that, if the usage in the instruction manual is not observed as to the mixed gasoline, etc. described therein, it may not be covered by the warranty.

8. Operation

STARTING ENGINE

1. Rest the unit on a flat, firm place.
2. Pump the primer until fuel flows out in the clear tube.

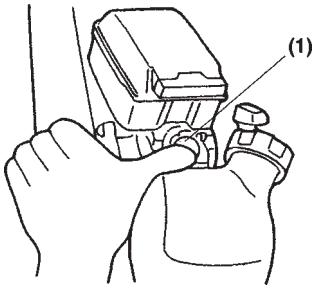

(1) Primer

3. Move the choke lever upward to close the choke.

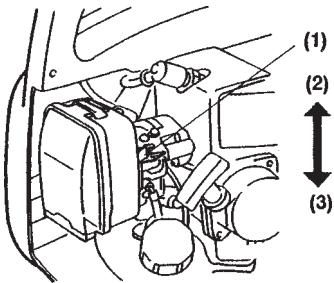

(1) Choke lever
(2) Close
(3) Open

4. Holding the blower handle, pull the starter rope with your right hand.
(Throttle lever in idle or start position.)

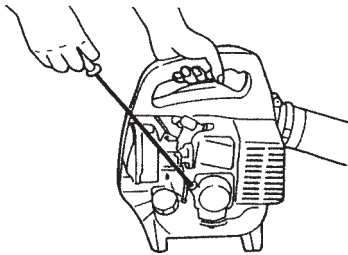

IMPORTANT

- Avoid pulling the starter rope out to its full extent and allowing the starter rope to snap back. This will prevent premature damage to the starter.
 - Do not let a person stand near the blower or the exhaust port.
5. When the engine has started, move the choke lever gradually downward to open the choke.
 6. Allow the engine to warm up for a half minute before starting operation.

RESTARTING ENGINE WHILE ENGINE IS HOT

1. When restarting the engine immediately after stopping it, leave the choke open.
2. If the engine won't start after several attempts, close the choke and repeat pulling the rope or remove the spark plug and dry it.

ADJUSTING IDLE SPEED

1. When the engine tends to stop frequently at an idle mode, turn the adjusting screw clockwise.

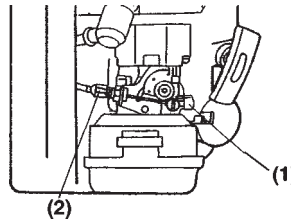

(1) Idling adjustment screw
(2) Cable Adjuster

NOTE

- Warm up the engine before adjusting the idle speed.

STOPPING ENGINE

- Move the throttle lever to the idling position and press the stop switch (red button) until the engine comes to a complete stop.

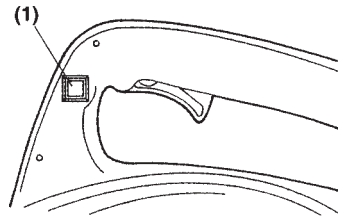

(1) Stop switch

NOTE

- Except for an emergency, avoid stopping the engine while pulling the throttle lever.

9. Maintenance

Maintenance, replacement, or repair of the emission control device and systems may be performed by any non-road engine repair establishment or individual.

System / Component		Procedure	Daily or Before use	Every 25 hours after	Every 50 hours after	Every 100 hours after
Air Filter	Prefilter	Inspect / Clean	✓			
Air Filter	Paper Filter	Inspect / Replace			✓	
Fuel Leaks		Inspect / Replace	✓			
Fuel Filter		Inspect / Replace	✓	✓		
Fuel Line		Inspect / Clean	✓			
Spark Plug		Inspect / Clean		✓		
Muffler		Inspect / Clean	✓			
Muffler Spark Arrester		Inspect / Clean			✓	
Cooling System		Inspect / Clean	✓			
Screws / Nuts / Bolts		Tighten	✓			
Cylinder Exhaust Port		Inspect / Clean				✓

⚠ WARNING

Make sure that the engine has stopped and is cool before performing any service to the blower. Contact with rotating blower fan or hot muffler may result in a personal injury.

AIR CLEANER

- Never operate the blower without an air filter or with a deformed or broken filter element.
- Check the air cleaner before use.
A clogged air filter may increase fuel consumption while cutting down the engine power. Never operate the blower without the air filter or with a deformed filter element because unfiltered dusty air will quickly ruin the engine.

CLEANING AIR FILTER:

[HB2302]

1. Remove the air cleaner cover by pushing and pulling back the tab on the top.
2. Use neutral detergent and warm water to clean the filter element. After cleaning, air dry the element completely.
3. Install the filter element into the air cleaner housing and press the cover against the housing until clicks. If the element is broken or shrunk, replace with a new one.

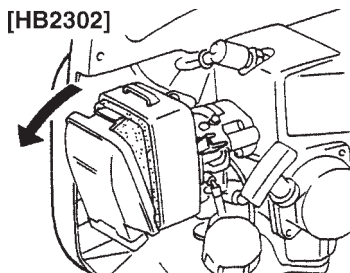

[HBZ2601]

1. Remove the air cleaner cover.

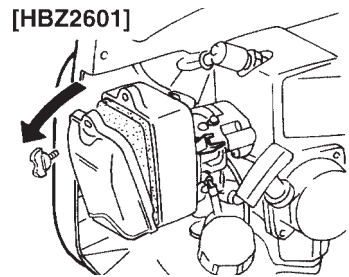

2. Use neutral detergent and warm water to clean the filter element. After cleaning, air dry the element completely.

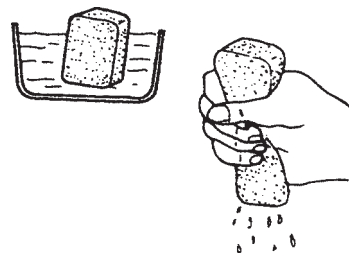

3. Reinstall the filter. Never forget to attach the screen. If the screen is not attached, the cleaner will not seal properly and the dusts come into the cylinder.

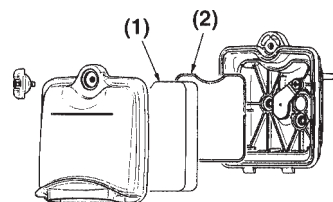

(1) Element
(2) Screen

9. Maintenance

FUEL FILTER

- A clogged fuel filter may cause poor acceleration of the engine. Check periodically to see if the filter is clogged with dirt. The filter can be taken out of the fueling port using a small wire hook. Disconnect the filter assembly from the fuel pipe and unhook the retainer to disassemble it. Clean the components with gasoline.

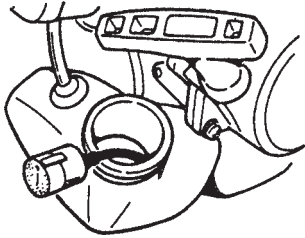

SPARK PLUG

- The spark plug may gather carbon deposits on its firing end with reasonable use. Remove and inspect the spark plug every 25 hours and clean the electrodes as necessary with a wire brush. The spark gap should be adjusted to .025 in (0.6~0.7mm).

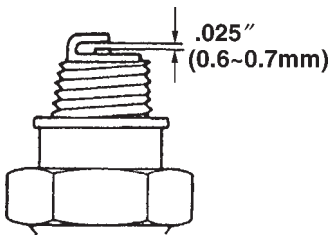

- Plug manufacturers recommend replacing the plug twice a year to avoid unexpected plug failure in a job.

REPLACEMENT PLUG

HB2302 : CHAMPION RCJ6Y
HBZ2601 : NGK CMR7A

ⓘ IMPORTANT

- Note that using any spark plugs other than those designated may result in the engine failing to operate properly or in the engine becoming overheated and damaged.
- To install the spark plug, first turn the plug until it is finger tight, then tighten it a quarter turn more with a socket wrench.

MUFFLER

⚠ WARNING

- Inspect periodically, the muffler for loose fasteners, any damage or corrosion. If any sign of exhaust leakage is found, do not use the blower and have it repaired immediately.
- Note that failing to do so may result in the engine catching on fire.

ⓘ IMPORTANT

- Before starting operation, always make sure to check if the muffler is properly held by three bolts to the cylinder. (Fastening Torque : 8~12 N·m)
- Even if one bolt out of three bolts is loose, the muffler may get loose during operation which may result in engine catching on fire.

PROCEDURES TO BE PERFORMED AFTER EVERY 100 HOURS OF USE

1. Remove the muffler, insert a screwdriver into the vent, and wipe away any carbon buildup. Wipe away any carbon buildup on the muffler exhaust vent and cylinder exhaust port at the same time.
2. Tighten all screws, bolts, and fittings.

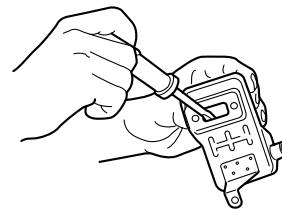

SPARK ARRESTER

- The engine is equipped with a spark arresting screen at the exhaust port. Periodically check and keep it in good condition. In the state of California it is required by law (Section 4442 of the California Public Resources Code) to equip a spark arrester when a gas powered tool is used in any forest covered, brush covered, or grass covered unimproved land.

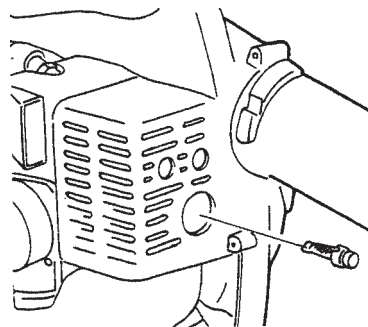

9. Maintenance

AIR INTAKE SCREEN (AIR INLET NET)

ⓘ IMPORTANT

- Blowing air is taken in from the air inlet net. When air flow has dropped down during operation, stop the engine and inspect the air inlet net for blocking by obstacles.
- Note that failure to remove any such obstacles may result in the engine becoming overheated and damaged.

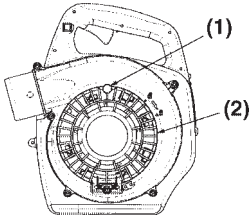

- (1) Screw
(2) Air intake screen
(Air inlet net)

⚠ WARNING

- Never use the blower without the net of the blower. Before each use, check that the net is attached in place and is free from any damage.

10. Storage

BEFORE STORING THE BLOWER:

1. Drain a fuel tank and push the primer bulb until it becomes empty of fuel.
2. Remove the spark plug and drop a spoonful of 2-cycle oil into the cylinder. Crank the engine several times and install the spark plug.
3. Store unit in a dry, dust free place, out of the reach of children.

GB

11. Disposal

When disposing your machine, fuel or oil for the machine, be sure to allow your local regulations.

12. Optional vacuum kit usage

Attach the adequate accessories, respectively for blower operation and dust-collecting operation.

NOTE

- Use the gloves during operation.
- In adjustment of the blower/dust collector or in other types of operation, be sure to stop the engine and detach the spark plug cap.
- Never start operation unless this machine is completely assembled.

MOUNTING THE DUST-COLLECTING KIT

1) Installing Support Handle

- This handle is supplied with the blower.
- Fit the holes of volute and handle, tighten the screws.
- Be sure to tighten the screws straightly.

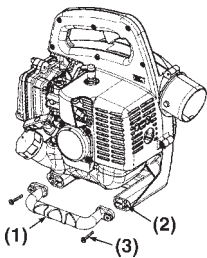

(1) Support Handle
(2) Holes
(3) Screws

2)

1. Fit the extension pipe (1) groove with main unit port projection, turn to mount the pipe to the main unit.
2. Tighten the clamp screw (2) securely.

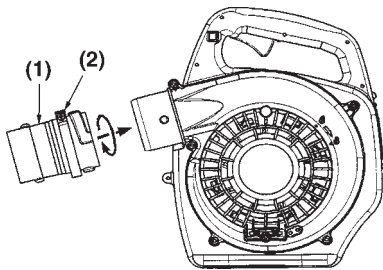

3) Installing Vacuum Pipe (nozzle)

1. Loosen the screw (3), and open the suction port cover.

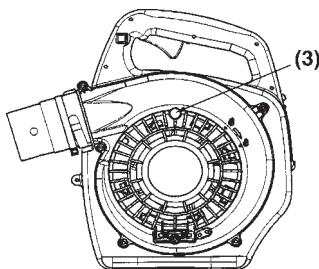

2. Align the □ (5) indicated on the vacuum pipe (4) with the 🔒 indicated on the blower. Then insert the vacuum pipe (4) into the blower.

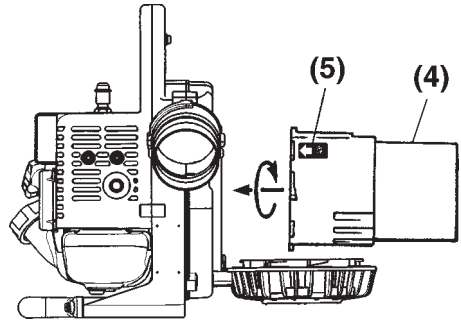

3. Turn the vacuum pipe (4) until the □ (5) is aligned with the 🔒 indicated on the blower to lock the vacuum pipe.

WARNING

- Hold the bottom of the vacuum pipe when turning the vacuum pipe to install or remove it.

4) Installing Elbow and Dust Bag

1. Open the fastener of the dust bag.

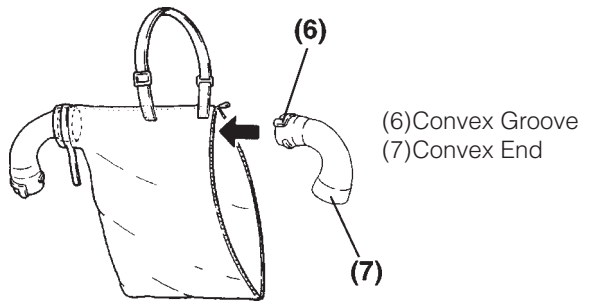

(6) Convex Groove
(7) Convex End

2. Insert the elbow convex groove into the dust bag elbow opening. Continue to push the elbow convex groove until the convex hits against the dust bag opening. Close the dust bag fastener.

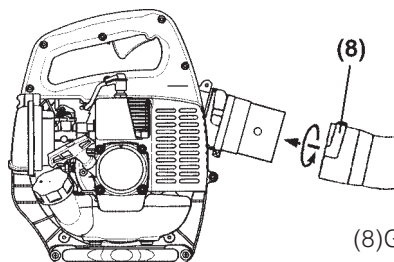

(8) Groove

12. Optional vacuum kit usage

- Fit the elbow groove with discharge port projection, turn the elbow and mount the dust bag to the main unit.

DUST COLLECTING OPERATION

- Put the dust bag belt on the shoulder, and adjust the length of the belt so as to permit easy operation.
- Confirm that the dust bag is not twisted, pull the throttle trigger, and start dust collecting operation.
- Detach the dust bag from the main unit when it is full of dust, open the dust bag fastener, and dispose of dust.

▲ WARNING

- Never suck in any liquid or lit cigarette. It will lead to an electric shock or burn.**

NOTE

- Never suck in large wood chips, metal, glass, small stones or other foreign materials.
- A filled dust bag will lessen dust-collecting capacity. It is advisable to discharge dust before it becomes too much.

- (A) Indicates Warning, Danger, and Caution.
 (B) Keep work area clear of other persons and pets.
 (C) Risk of long hair being drawn into air inlet.
 (D) Wear head, eye, and hearing protection when operating this equipment.
 (E) Do not run unit while vacuum door is unsecured.

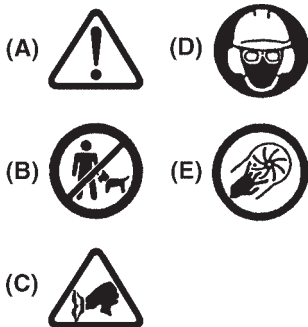

13. Troubleshooting guide

Case 1. Starting failure

CHECK	PROBABLE CAUSES	ACTION
fuel tank	→ incorrect fuel	→ drain it and use correct fuel
fuel filter	→ fuel filter is clogged	→ clean
carburetor adjustment screw	→ out of normal range	→ adjust to normal range
sparkign (no spark)	→ spark plug is fouled/wet → plug gap is incorrect	→ clean/dry → correct (GAP: 0.6 ~ 0.7 mm)
spark plug	→ disconnected	→ retighten

Case 2. Engine starts but does not keep running/hard re-starting

CHECK	PROBABLE CAUSES	ACTION
fuel tank	→ incorrect fuel or staled fuel	→ drain it and use correct fuel
carburetor adjustment screw	→ out of normal range	→ adjust to normal range
muffler, cylinder (exhaust port)	→ carbon is built-up	→ wipe away
air cleaner	→ clogged with dust	→ wash
cylinder fin, fan cover	→ clogged with dust	→ clean

When your unit seems to need further service, please consult with our ZENOAH service shop in your area.

Limited warranty

Should any failure occur on the product under normal operating conditions within the applicable warranty period, the failed part will be replaced or repaired free of charge by a ZENOAH authorized dealer.

WARRANTY PERIOD: 1 year (6 months if used professionally, and 30 days if used for rental purpose) from the date of initial purchase.

THE PURCHASER SHALL BEAR COSTS OF TRANSPORTING THE UNIT TO AND FROM THE ZENOAH DEALER.

THE PURCHASER SHALL NOT BE CHARGED FOR DIAGNOSTIC LABOR WHICH LEADS TO THE DETERMINATION THAT A WARRANTED PART IS DEFECTIVE, IF THE DIAGNOSTIC WORK IS PERFORMED AT THE ZENOAH DEALER.

THE PURCHASER OR OWNER IS RESPONSIBLE FOR THE PERFORMANCE OF THE REQUIRED MAINTENANCE AS DEFINED BY THE MANUFACTURER IN THE OWNER/OPERATOR MANUAL.

ANY WARRANTED PART WHICH IS NOT SCHEDULED FOR REPLACEMENT AS REQUIRED MAINTENANCE, OR WHICH IS SCHEDULED ONLY FOR REGULAR INSPECTION TO THE EFFECT OF REPAIR OR "REPLACE AS NECESSARY" SHALL BE WARRANTED FOR THE WARRANTY PERIOD. ANY WARRANTED PART WHICH IS SCHEDULED FOR REPLACEMENT AS REQUIRED MAINTENANCE SHALL BE WARRANTED FOR THE PERIOD OF TIME UP TO THE FIRST SCHEDULED REPLACEMENT POINT FOR THE PART.

ANY REPLACEMENT PART THAT IS EQUIVALENT IN PERFORMANCE AND DURABILITY MAY BE USED IN NON-

WARRANTY MAINTENANCE OR REPAIRS, AND SHALL NOT REDUCE THE WARRANTY OBLIGATION OF THE COMPANY.

THE COMPANY IS LIABLE FOR DAMAGES TO OTHER ENGINE COMPONENTS CAUSED BY THE FAILURE OF A WARRANTED PART STILL UNDER WARRANTY.

THE WARRANTY DOES NOT APPLY TO THOSE UNITS WHICH HAVE BEEN DAMAGED BY NEGLIGENCE OF INSTRUCTION LISTED IN THE OWNER/OPERATOR MANUAL FOR PROPER USE AND MAINTENANCE OF THE UNITS ACCIDENT MISHANDLING, ALTERATION, ABUSE, IMPROPER LUBURICATION, USE OF ANY PARTS OR ACCESSORIES OTHER THAN THOSE SPECIFIED BY THE COMPANY, OR OTHER CAUSES BEYOND THE COMPANY'S CONTROL.

THIS WARRANTY DOES NOT COVER THOSE PARTS REPLACED BY NORMAL WEAR OR HARMLESS CHANGES IN THEIR APPEARANCE.

THERE ARE NO OTHER EXPRESS WARRANTIES.

IMPLIED WARRANTIES INCLUDING THOSE OF MERCHANTABILITY AND FITNESS FOR A PARTICULAR PURPOSE **ARE LIMITED** TO TWO (2) YEARS OF HOME USE [ONE (1) YEAR FOR ANY OTHER USE] FROM THE ORIGINAL DELIVERY DATE.

LIABILITIES FOR INCIDENTAL OR CONSEQUENTIAL DAMAGE UNDER ANY AND ALL WARRANTIES ARE EXCLUDED.

IF YOU NEED TO OBTAIN MORE INFORMATION, PLEASE CALL YOUR NEAREST SERVICE CENTER, OR CHECK PLEASE ZENOAH WEB SITE <http://www.zenoah.net>