



**OWNER'S MANUAL**



**CHAIN SAW**

**G6200**

**⚠ WARNING ⚠**

 Before using our products, please read this manual carefully to understand the proper use of your unit.

## EXPLANATION OF SYMBOLS AND SAFETY WARNINGS



Read operator's instruction book before operating this machine.



Wear head, eye and ear protection.



Use the chain saw with two hands.



Warning! Danger of kickback.



Read, understand and follow all warnings.



Never touch hot surface.

**WARNING!!!**

**RISK OF DAMAGING HEARING**

**Wear head, eye and ear protection.**

**112**<sub>dB</sub>

MODEL	SOUND LEVEL		VIBRATION LEVEL			
	EN 608 - ISO 7182	2000/14/EC	ISO 22867		2002/44/EC	
G6200	$L_{pA}$	$L_{WA}$	Front handle	Rear handle	A (8)	
	99.3 dB(A)	112 dB(A)	5.1 m/s <sup>2</sup>	6.3 m/s <sup>2</sup>	Front handle	Rear handle
					3.5 m/s <sup>2</sup>	4.3 m/s <sup>2</sup>

**APPROVAL NUMBER OF CE EXHAUST EMISSION REGULATION (2002/88/EC)**

**e13\*97/68SH3G3\*2002/88\*0108\*01**

**DECLARATION OF CONFORMITY TO MACHINES DIRECTIVE**

(Directive 98/37/EC, 89/336/EEC)  
and to the regulations governing transposition  
Internal control production

MANUFACTURER : Husqvarna Zenoah Co., Ltd.  
No. 9, 1-Chome  
MINAMIDAI, KAWAGOE City  
SAITAMA, JAPAN

DECLARES THAT THE DESIGN OF THE MACHINE DESCRIBED BELOW :

Model : G6200  
Serial no. : 800001 and up  
Make : Husqvarna Zenoah

CONFORMS TO THE REQUIREMENTS OF THE MODIFIED MACHINES  
DIRECTIVE (Directive 98/37/EC) AND TO THE NATIONAL REGULATIONS  
GOVERNING ITS TRANSPOSITION ABROAD : AND

THAT IT HAS BEEN ISSUED WITH A "CE" CERTIFICATE, NO. U3 2892006 01  
BY TÜV Rheinland Group - TÜV Rheinland InterCert kft. Product Certification -  
H-1061 Budapest Paulay Ede u. 52 - HUNGARY

Signed in Saitama, Japan **1st March 2008**



Masahiko GOUDA  
General Manager, Quality Assurance Department

## Contents

1. For Safe Operation .....	4
2. Explanation of Symbols on the Machine .....	6
3. Installing Guide Bar and Saw Chain .....	7
4. Fuel and Chain Oil .....	8
5. Operating the Engine .....	9
6. Sawing .....	11
7. Maintenance .....	12
8. Maintenance of Saw Chain and Guide Bar .....	14
9. Troubleshooting Guide .....	15
10. Disposal .....	15
11. Specifications .....	15

# 1. For safe operation



1. Never operate a chain saw when you are fatigued, ill, or upset, or under the influence of medication that may make you drowsy, or if you are under the influence of alcohol or drugs.

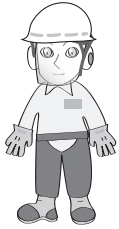

2. Use safety footwear, snug fitting clothing and eye, hearing and head protection devices. Use the vibration-proof glove.



3. Keep the saw chain sharp and the saw, including the AV system, well maintained. A dull chain will increase cutting time, and pressing a dull chain through wood will increase the vibrations transmitted to your hands. A saw with loose components or with damaged or worn AV buffers will also tend to have higher vibration levels.

4. Always use caution when handling fuel. Wipe up all spills and then move the chain saw at least 3 m from the fueling point before starting the engine.



5. Eliminate all sources of sparks or flame (i.e. smoking, open flames, or work that can cause sparks) in the areas where fuel is mixed, poured, or stored.

6. Do not smoke while handling fuel or while operating the chain saw.

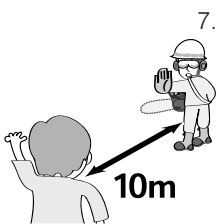

7. Do not allow other persons to be near the chain saw when starting or cutting. Keep bystanders and animals out of the work area. Children, pets and bystanders should be a minimum of 10 m away when you start or operate the chain saw.

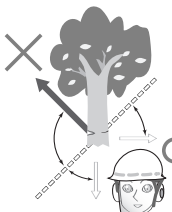

8. Never start cutting until you have a clear work area, secure footing, and a planned retreat path from the falling tree.

9. Always hold the chain saw firmly with both hands when the engine is running. Use a firm grip with thumb and fingers encircling the chain saw handles.

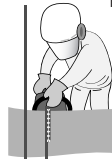

10. Keep all parts of your body away from the saw chain when the engine is running.



11. Before you start the engine, make sure the saw chain is not contacting anything.

12. Always carry the chain saw with the engine stopped, the guide bar and saw chain to the rear, and the muffler away from your body.

13. Always inspect the chain saw before each use for worn, loose, or damaged parts. Never operate a chain saw that is damaged, improperly adjusted, or is not completely and securely assembled. Be sure that the saw chain stops moving when the throttle control trigger is released.



14. All chain saw service, other than the items listed in the Owner's Manual, should be performed by competent chain saw service personnel. (E.g., if improper tools are used to remove the flywheel, or if an improper tool is used to hold the flywheel in order to remove the clutch, structural damage to the flywheel could occur which could subsequently cause the flywheel to disintegrate.)



15. Always shut off the engine before setting it down.

16. Use extreme caution when cutting small size brush and saplings because slender material may catch the saw chain and be whipped toward you or pull you off balance.



17. When cutting a limb that is under tension, be alert for spring-back so that you will not be struck when the tension in the wood fibers is released.

18. Never cut in high wind, bad weather, when visibility is poor or in very high or low temperatures. Always check the tree for dead branches which could fall during the felling operation.



19. Keep the handles dry, clean and free of oil or fuel mixture.

20. Operate the chain saw only in well ventilated areas. Never start or run the engine inside a closed room or building and potentially explosive atmosphere. Exhaust fumes contain dangerous carbon monoxide.



21. Do not operate the chain saw in a tree unless specially trained to do so.

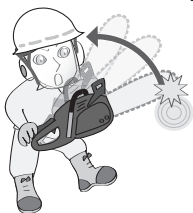

22. Guard against kickback. Kickback is the upward motion of the guide bar which occurs when the saw chain at the nose of the guide bar contacts an object. Kickback can lead to dangerous loss of control of the chain saw.



- (3) Make certain that the area in which you are cutting is free from obstructions. Do not let the nose of the guide bar contact a log, branch, or any other obstruction which could be hit while you are operating the saw.

23. When transporting your chain saw, make sure the appropriate guide bar scabbard is in place.

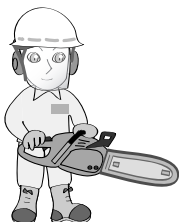

24. Never touch the cover, guide bar, saw chain or nut with bare hands while the engine is in operation or immediately after shutting down the engine. Doing so could result in serious burns because of high temperature.

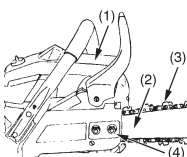

- (1) cover  
(2) guide bar  
(3) saw chain  
(4) nut



- (4) Cut at high engine speeds.  
(5) Do not overreach or cut above shoulder height.  
(6) Follow the manufacturer's sharpening and maintenance instructions for the saw chain.  
(7) Only use replacement bars and chains specified by the manufacturer or the equivalent.

## KICKBACK SAFETY PRECAUTIONS FOR CHAIN SAW USERS



### WARNING

- Kickback may occur when the nose or tip of the guide bar touches an object, or when the wood closes in and pinches the saw chain in the cut. Tip contact in some cases may cause a lightning fast reverse reaction, kicking the guide bar up and back towards the operator. Pinching the saw chain along the top of the guide bar may push the guide bar rapidly back towards the operator. Either of these reactions may cause you to lose control of the saw, which could result in serious personal injury.
- Do not rely exclusively on the safety devices built into your saw. As a chain saw user you should take several steps to keep cutting jobs free from accident or injury.

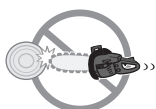

- (1) With a basic understanding of kickback you can reduce or eliminate the element of surprise. Sudden surprise contributes to accidents.



- (2) Keep a good grip on the saw with both hands, the right hand on the rear handle, and the left hand on the front handle, when the engine is running. Use a firm grip with thumbs and fingers encircling the chain saw handles. A firm grip will help you reduce kickback and maintain control of the saw.



## WORSE EFFECTS OF VIBRATION

If you continue to use high-vibration tools these symptoms will probably get worse, for example:

- the numbness in your hands could become permanent and you won't be able to feel things at all;
- you will have difficulty picking up small objects such as screws or nails;
- the vibration white finger could happen more frequently and affect more of your fingers.

## FOR PROTECTING YOUR BODY FROM VIBRATION

Please observe the following matter, in order to protect the health of your body.

1. Always use the right tool for each job (to do the job more quickly and expose you to less hand-arm vibration).
2. Check tools before using them to make sure they have been properly maintained and repaired to avoid increased vibration caused by faults or general wear.
3. Make sure cutting tools are kept sharp so that they remain efficient.
4. Reduce the amount of time you use a tool in one go, by doing other jobs in between.
5. Avoid gripping or forcing a tool or workpiece more than you have to.
6. Store tools so that they do not have very cold handles when next used.
7. Encourage good blood circulation by:
  - keeping warm and dry (when necessary, wear gloves, a hat, waterproofs and use heating pads if available);
  - giving up or cutting down on smoking because smoking reduces blood flow; and massaging and exercising your fingers

## DISPOSAL

When disposing your machine, fuel or oil for the machine, be sure to allow your local regulations.

## 2. Explanation of Symbols on the Machine

### ▲ WARNING

- For safe operation and maintenance, symbols are carved in relief on the machine. According to these indications, please be careful not to make any mistake.



The port to refuel "MIX GASOLINE"  
**Position:** Fuel cap



The port to top up chain oil  
**Position:** Oil cap



Setting the switch to the " I " position, the engine starts.  
 Setting the switch to the " O " position, the engine stops immediately.  
**Position:** Rear-left of the unit



If you pull out the choke knob, you can set the choke as a cold start mode.  
**Position:** Upper-right of the aircleaner cover

H

The screw under the "H" stamp is The High-speed adjustment screw.

L

The screw under the "L" stamp is The Slow-speed adjustment screw.

T

The screw at the left of the "T" stamp is the Idle adjustment screw.  
**Position:** Left side of the rear handle



Shows the directions that the chain brake is released (white arrow) and activated (black arrow).  
**Position:** Front of the chain cover



If you turn the knob by hand follow the arrow to the "MAX" position, the chain oil flow more, and if you turn to the "MIN" position, less.  
**Position:** Top of the cylinder cover

### 3. Installing Guide Bar and Saw Chain

A standard saw unit package contains the items as illustrated.

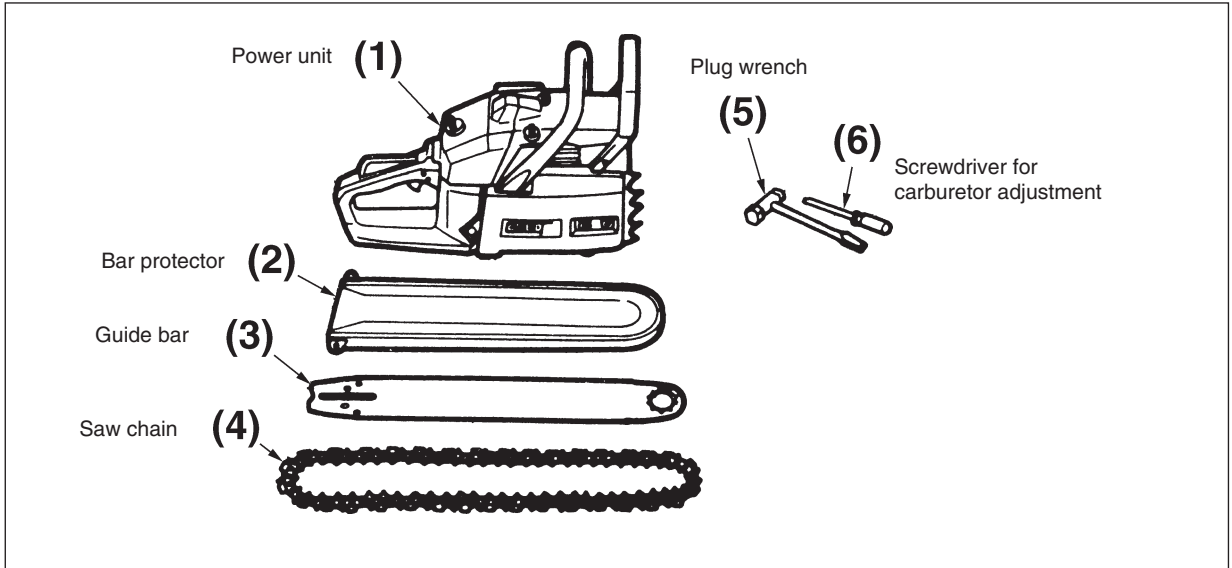

Open the box and install the guide bar and the saw chain on the power unit as follows:

#### **⚠ WARNING**

• **The saw chain has very sharp edges. Use thick protective gloves for safety.**

1. Pull the guard towards the front handle to check that the chain brake is not engaged.
2. Loosen the nuts and remove the chain cover.

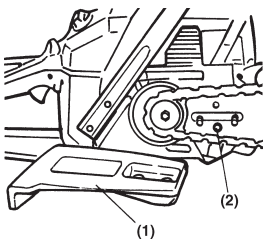

3. Install the attached spike to the power unit.
4. Gear the chain to the sprocket and, while fitting the guide bar to the power unit, mount the guide bar to the power unit. Adjust the position of chain tensioner nut on the chain cover to the lower hole of guide bar.

#### **📖 NOTE**

- Pay attention to the correct direction of the saw chain.

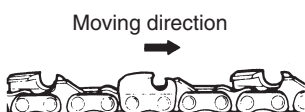

5. Fit the chain cover to the power unit and fasten the nuts to finger tightness.
6. While holding up the tip of the bar, adjust the chain tension by turning the tensioner screw until the tie straps just touch the bottom side of the bar rail.
7. Tighten the nuts securely with the bar tip held up (12 ~ 15 N·m). Then check the chain for smooth rotation and proper tension while moving it by hand. If necessary, readjust with the chain cover loose.
8. Tighten the tensioner screw.

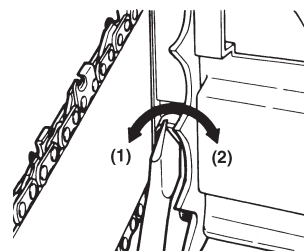

#### **📖 NOTE**

- A new chain will expand its length in the beginning of use. Check and readjust the tension frequently as a loose chain can easily derail or cause rapid wear of itself and the guide bar.

## 4. Fuel and Chain Oil

### ■ FUEL

#### ▲ WARNING

- **Gasoline is very flammable. Avoid smoking or bringing any flame or sparks near fuel. Make sure to stop the engine and allow it cool before refueling the unit. Select outdoor bare ground for fueling and move at least 3 m (10 ft) away from the fueling point before starting the engine.**



- The Zenoah engines are lubricated by oil specially formulated for air-cooled 2-cycle gasoline engine use. If Zenoah oil is not available, use an anti-oxidant added quality oil expressly labeled for air-cooled 2-cycle engine use (JASO FC GRADE OIL or ISO EGC GRADE).
- Do not use BIA or TCW (2-stroke water-cooling type) mixed oil.



### ■ RECOMMENDED MIXING RATIO GASOLINE 50 : OIL 1 (when using ZENOAH genuine oil)

- **Exhaust emission are controlled by the fundamental engine parameters and components (eq., carburation, ignition timing and port timing) without addition of any major hardware or the introduction of an inert material during combustion.**
- These engines are certified to operate on unleaded gasoline.
- Make sure to use gasoline with a minimum octane number of 89RON (USA/Canada: 87AL).
- If you use a gasoline of a lower octane value than prescribed, there is a danger that the engine temperature may rise and an engine problem such as piston seizing may consequently occur.
- Unleaded gasoline is recommended to reduce the contamination of the air for the sake of your health and the environment.
- Poor quality gasolines or oils may damage sealing rings, fuel lines or fuel tank of the engine.

### ■ HOW TO MIX FUEL

#### ▲ WARNING

- **Pay attention to agitation.**
1. Measure out the quantities of gasoline and oil to be mixed.
  2. Put some of the gasoline into a clean, approved fuel container.
  3. Pour in all of the oil and agitate well.

4. Pour in the rest of gasoline and agitate again for at least one minute. As some oils may be difficult to agitate depending on oil ingredients, sufficient agitation is necessary for the engine to last long. Be careful that, if the agitation is insufficient, there is an increased danger of early piston seizing due to abnormally lean mixture.
5. Put a clear indication on the outside of the container to avoid mixing up with gasoline or other containers.
6. Indicate the contents on outside of container for easy identification.

### ■ FUELING THE UNIT

1. Untwist and remove the fuel cap. Rest the cap on a dustless place.
2. Put fuel into the fuel tank to 80% of the full capacity.
3. Fasten the fuel cap securely and wipe up any fuel spillage around the unit.

#### ▲ WARNING

1. **Select flat and bare ground for fueling.**
2. **Move at least 10 feet (3 meters) away from the fueling point before starting the engine.**
3. **Stop the engine before refueling the unit. At that time, be sure to sufficiently agitate the mixed gasoline in the container.**

### ■ FOR YOUR ENGINE LIFE, AVOID:

1. **FUEL WITH NO OIL (RAW GASOLINE)** – It will cause severe damage to the internal engine parts very quickly.
2. **GASOHOL** – It can cause deterioration of rubber and/or plastic parts and disruption of engine lubrication.
3. **OIL FOR 4-CYCLE ENGINE USE** – It can cause spark plug fouling, exhaust port blocking, or piston ring sticking.
4. **Mixed fuels which have been left unused for a period of one month or more** may clog the carburetor and result in the engine failing to operate properly.
5. In the case of storing the product for a long period of time, clean the fuel tank after rendering it empty. Next, activate the engine and empty the carburetor of the composite fuel.
6. In the case of scrapping the used mixed oil container, scrap it only at an authorized repository site.

#### 📖 NOTE

- As for details of quality assurance, read the description in the section Limited Warranty carefully. Moreover, normal wear and change in product with no functional influence are not covered by the warranty. Also, be careful that, if the usage in the instruction manual is not observed as to the mixed gasoline, etc. described therein, it may not be covered by the warranty.

### ■ CHAIN OIL

Use motor oil SAE #10W-30 all year round or SAE #30 ~ #40 in summer and SAE #20 in winter.

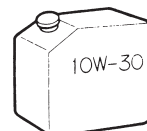

#### 📖 NOTE

Do not use wasted or regenerated oil that can cause damage to the oil pump.



# 5. Operating the Engine

## ▲ WARNING

- It is very dangerous to run a chainsaw that mounts broken parts or lacks any parts. Before starting engine, make sure that all the parts including bar and chain are installed properly.

## ■ STARTING THE ENGINE

- Fill fuel and chain oil tanks respectively, and tighten the caps securely.

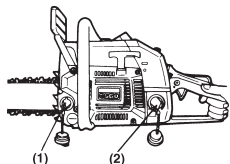

(1) Chain oil  
(2) Fuel

- Set the switch to "I" position.

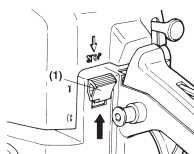

(1) Switch

- While holding the throttle lever together with the trigger safety, push in the side latch and release the throttle lever to leave it at the starting position.

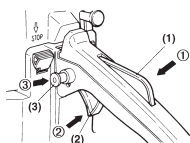

(1) Trigger safety  
(2) Throttle lever  
(3) Latch

- Pull out the choke knob to the closed position.

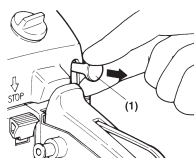

(1) Choke knob

## 📖 NOTE

- When restarting immediately after stopping the engine, leave the choke knob at the open position.
- While holding the saw unit securely on the ground, pull the starter rope vigorously.



## ▲ WARNING

- Do not start the engine while the chain saw hangs in one hand. The saw chain may touch your body. This is very dangerous.

- When firing occur, push in the choke knob and pull the starter again to start the engine.

- Allow the engine to warm up with the throttle lever pulled slightly.

## ▲ WARNING

- Keep clear of the saw chain as it will start rotating upon starting of engine.

## ■ CHECKING THE OIL SUPPLY

### ▲ WARNING

- Make sure to set up the bar and the chain when checking the oil supply. If not, the rotating parts may be exposed. It is very dangerous.

After starting the engine, run the chain at medium speed and see if chain oil is scattered off as shown in the figure.

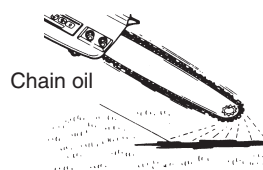

Chain oil

The oil flow can be changed by turning the adjuster knob on the top of the cylinder cover. Adjustment according to your work conditions.

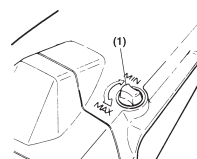

(1) Adjuster knob

## 📖 NOTE

- The oil tank should become nearly empty by the time fuel is used up. Be sure to refill the oil tank every time when refueling the saw.

## ■ ADJUSTING THE CARBURETOR

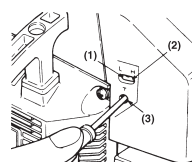

(1) L needle  
(2) H needle  
(3) Idle adjusting screw

The carburetor has been adjusted at the factory. Should your unit need readjustment due to the changes in altitude or operating conditions, please let your skillful dealer make the adjustment. A wrong adjustment may cause damage to your unit. If you have to make the adjustment yourself, please follow the procedure below carefully.

When adjusting, take the following steps:

## 📖 NOTE

- Be sure to adjust the carburetor with the bar chain attached.

1. H and L needles are restricted within the number of turn as shown below.

H needle :  $-1/4$   
L needle :  $-1/4$

2. Start the engine and allow it to warm up in low speed for a few minutes.
3. Turn the idle adjusting screw (T) counterclockwise so that the saw chain does not turn. If the idling speed is too slow, turn the screw clockwise.
4. Make a test cut and adjust the H needle for best cutting power, not for maximum speed.

### NOTE

- Over revolution of H needle causes a lack of power or a poor acceleration. In such a case please turn the H needle a little counterclockwise.

### ■ CHAIN BRAKE

This machine is equipped with an automatic brake to stop saw chain rotation upon occurrence of kickback during saw cutting. The brake is automatically operated by inertial force, which acts on the weight fitted inside the front guard.

This brake can also be operated manually with the front guard turned down to the guide bar.

To release the brake, pull up the front guard toward the front handle till a "click" sound is heard.

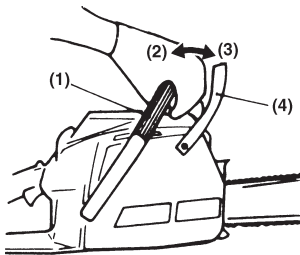

- (1) Front handle
- (2) Released
- (3) Braking
- (4) Brake lever

### [Caution]

Be sure to confirm brake operation during daily inspection.

### How to confirm:

- 1) Turn off the engine.
- 2) Holding the chain saw horizontally, release your hand from the front handle, hit the tip of the guide bar to a stump or a piece of wood, and confirm brake operation. Operating level varies by bar size.

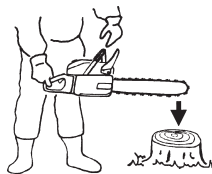

In case the brake is not effective, ask our dealer for inspection and repairs.

If the engine keeps rotating at high speed with the brake engaged, the clutch will overheat causing trouble.

When the brake engages during operation, immediately release the throttle lever to stop the engine.

### ■ ICING PREVENTION SYSTEM

This system prevents icing of the carburetor which sometimes happen while sawing in winter.

When your saw has stopped or slowed down abruptly, use the system as follows:

1. Remove the air cleaner cover, air filter, and silencer.

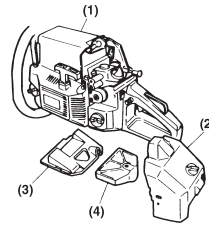

- (1) Cylinder cover
- (2) Air cleaner cover
- (3) Intake silencer
- (4) Air filter

2. Unhook the hatch on the rear wall of the cylinder cover and turn it upside down.

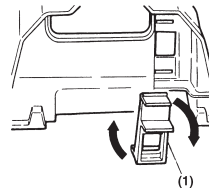

- (1) Hatch

3. Install the covers as they are.

### WARNING

- Never use the system in normal temperature because that can cause starting failure due to overheating of the carburetor.

### ■ STOPPING THE ENGINE

1. Release the throttle lever to allow the engine to idle for a few minutes.
2. Set the switch to the "O" (STOP) position.



- (1) Switch

## 6. Sawing

### ⚠ WARNING



- Before proceeding to your job, read the section “For Safe Operation”. It is recommended to first practice sawing easy logs. This also helps you get accustomed to your unit.
- Always follow the safety regulations. The chain saw must only be used for cutting wood. It is forbidden to cut other types of material. Vibrations and kickback vary with different materials and the requirements of the safety regulations would not be respected. Do not use the chain saw as a lever for lifting, moving or splitting objects. Do not lock it over fixed stands. It is forbidden to hitch tools or applications to the PTO other than those specified by the manufacturer.



- It is not necessary to force the saw into the cut. Apply only light pressure while running the engine at full throttle.
- When the saw chain is caught in the cut, do not attempt to pull it out by force, but use a wedge or a lever to open the way.

### ■ GUARD AGAINST KICKBACK

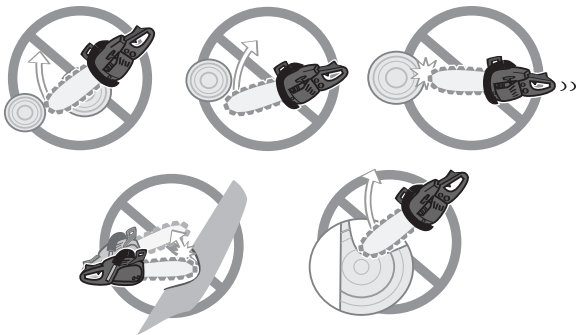

- This saw is equipped with a chain brake that will stop the chain in the event of kickback if operating properly. You must check the chain brake operation before each usage by running the saw at full the throttle for 1 - 2 seconds and pushing the front hand guard forward. The chain should stop immediately with the en-

gine at full speed. If the chain is slow to stop or does not stop, replace the brake band and clutch drum before use.

- It is extremely important that the chain brake be checked for proper operation before each use and that the chain be sharp in order to maintain the kickback safety level of this saw. Removal of the safety devices, inadequate maintenance, or incorrect replacement of the bar or chain may increase the risk to serious personal injury due to kickback.



### ■ FELLING A TREE

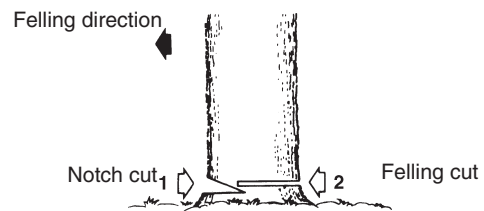

1. Decide the felling direction considering the wind, lean of the tree, location of heavy branches, ease of completing the task after felling and other factors.
2. While clearing the area around the tree, arrange a good foothold and retreat path.
3. Make a notch cut one-third of the way into the tree on the felling side.
4. Make a felling cut from the opposite side of the notch and at a level slightly higher than the bottom of the notch.

### ⚠ WARNING

- When you fell a tree, be sure to warn neighboring workers of the danger.

### Bucking and Limbing

### ⚠ WARNING

- Always ensure your foothold. Do not stand on the log.
- Be alert to the rolling over of a cut log. Especially when working on a slope, stand on the uphill side of the log.
- Follow the instructions in “For Safe Operation” to avoid kickback of the saw.

Before starting work, check the direction of bending force inside the log to be cut. Always finish cutting from the opposite side of the bending direction to prevent the guide bar from being caught in the cut.

### A log lying on the ground

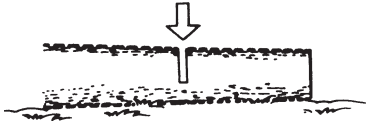

Saw down halfway, then roll the log over and cut from the opposite side.

### A log hanging off the ground

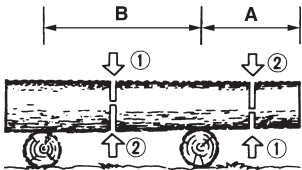

In area A, saw up from the bottom one-third and finish by sawing down from the top. In area B, saw down from the top one-third and finish by sawing up from the bottom.

### Cutting the limbs of Fallen Tree

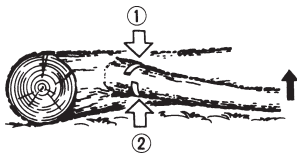

First check to which side the limb is bent. Then make the initial cut from the bent side and finish by sawing from the opposite side.

#### ⚠ WARNING

- Be alert to the springing back of a cut limb.

### Pruning of Standing Tree

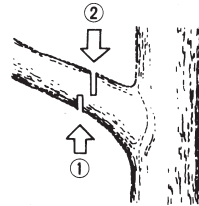

Cut up from the bottom, finish down from the top.

#### ⚠ WARNING

- Do not use an unstable foothold or ladder.
- Do not overreach.
- Do not cut above shoulder height.
- Always use both your hands to hold the saw.

## 7. Maintenance

#### ⚠ WARNING

- Before cleaning, the inspecting or repairing the unit, make sure that engine has stopped and is cool. Disconnect the spark plug to prevent accidental starting.

### ■ MAINTENANCE AFTER EACH USE

#### 1. Air filter

Loosen the knob and remove the air cleaner cover. Take off the filter element and brush off attached sawdust. When the filter is clogged with dust, separate it in halves and shake-wash with gasoline.

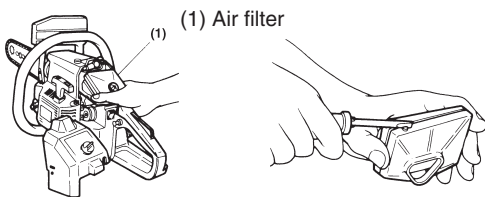

#### 📖 NOTE

- When servicing the air filter, be sure to block the air intake hole with cloth.

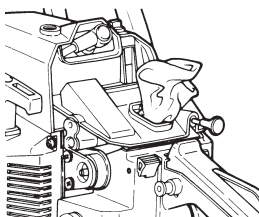

#### 2. Oiling port

Dismount the guide bar and check the oiling port for clogging.

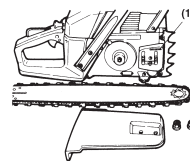

Oiling port

#### 3. Guide bar

When the guide bar is dismounted, remove sawdust in the bar groove and the oiling port.

Grease the nose sprocket from the feeding port on the tip of the bar.

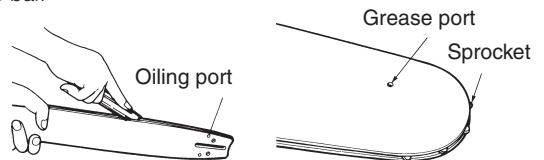

#### 4. Others

Check for fuel leakage and loose fastenings and damage to major parts, especially handle joints and guide bar mounting. If any defects are found, make sure to have them repaired before operating the saw again.

## ■ PERIODICAL SERVICE POINTS

### 1. Cylinder fins

Dust clogging between the cylinder fins will cause overheating of the engine. Periodically check and clean the cylinder fins after removing the air cleaner and the cylinder cover. When installing the cylinder cover, make sure that switch wires and grommets are positioned correctly in place.

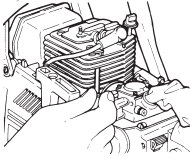

#### NOTE

- Be sure to block the air intake hole.

### 2. Fuel filter

(a) Using a wire hook, take out the filter from the filler port.

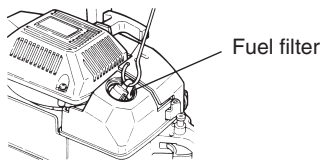

(b) Disassemble the filter and wash with gasoline, or replace with a new one if needed.

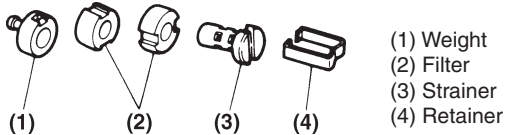

#### NOTE

- After removing the filter, use a pinch to hold the end of the suction pipe.
- When assembling the filter, take care not to allow filter fibers or dust inside the suction pipe.

### 3. Oil tank

Drain the oil tank and clean the inside with gasoline.

### 4. Spark plug

0.6 ~ 0.7 mm



NGK  
BPMR7A

Clean the electrodes with a wire brush and reset the gap to 0.65 mm as necessary.

### 5. Sprocket

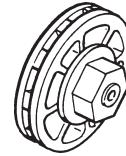

Check for cracks and for excessive wear interfering with the chain drive. If the wear is considerable, replace it with new one. Never fit a new chain on a worn sprocket, or a worn chain on a new sprocket.

### 6. Front and Rear dampers

Replace if adhered part is peeled or crack is observed on the rubber part. Replace if the inside of the rear damper metal has been beaten by the stopper bolt and the clearance of the metal increased.

# 8. Maintenance of Saw Chain and Guide Bar

## ■ Saw Chain

### ▲ WARNING

- It is very important for smooth and safe operation to always keep the cutters sharp.

The cutters need to be sharpened when:

- Sawdust becomes powder-like.
- You need extra force to saw in.
- The cut path does not go straight.
- Vibration increases.
- Fuel consumption increases.

Cutter setting standards:

### ▲ WARNING

- Be sure to wear safety gloves.

Before filing:

- Make sure the saw chain is held securely.
- Make sure the engine is stopped.
- Use a round file of proper size for the chain.

Chain type: 73LGX

File size: 7/32 in. (5.6 mm)

Place the file on the cutter and push straight forward. Keep the file position as illustrated.

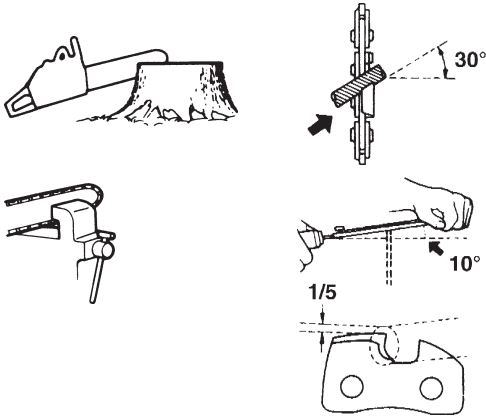

After each cutter has been filed, check the depth gauge and file it to the proper level as illustrated.

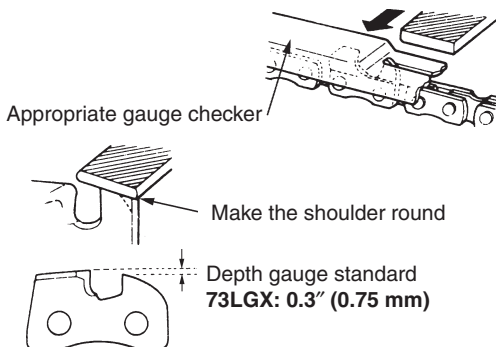

### ▲ WARNING

- Be sure to round off the front edge to reduce the chance of kickback or tie-strap breakage.

Make sure every cutter has the same length and edge angles as illustrated.

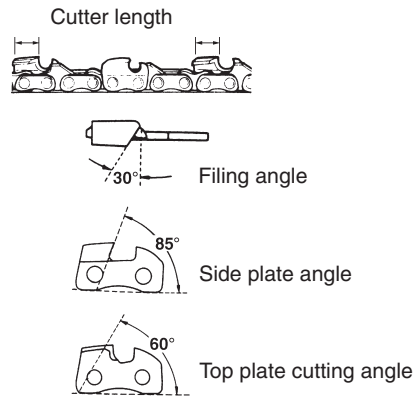

## ■ Guide Bar

- Reverse the bar occasionally to prevent partial wear.
- The bar rail should always be square. Check for wear of the bar rail. Apply a ruler to the bar and the outside of a cutter. If a gap is observed between them, the rail is normal. Otherwise, the bar rail is worn. Such a bar needs to be corrected or replaced.

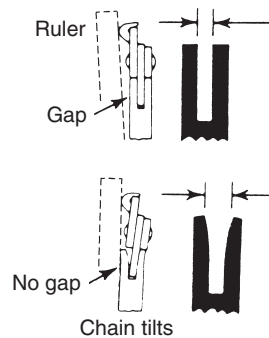

### ▲ WARNING

- This saw is equipped with one of the following low kickback bar/chain combinations:

Bar Size	Guide Bar	Zenoah Part Number
		Saw Chain
16	3670-52112	848CC3LG60 (73LGX)
18	3673-52113	848CC3LG66 (73LGX)
20	3674-52113	848CC3LG72 (73LGX)

## 9. Troubleshooting Guide

### Case 1. Starting failure

#### ▲ WARNING

- Make sure the icing prevention system is not working.

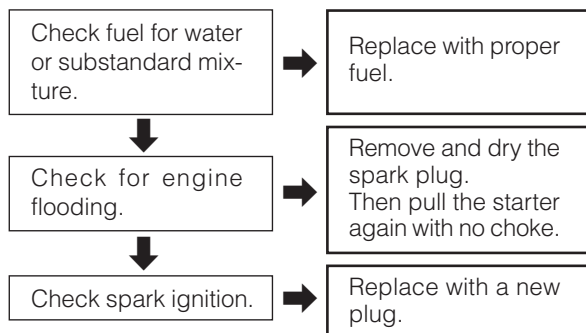

### Case 2. Lack of power/Poor acceleration/ Rough idling

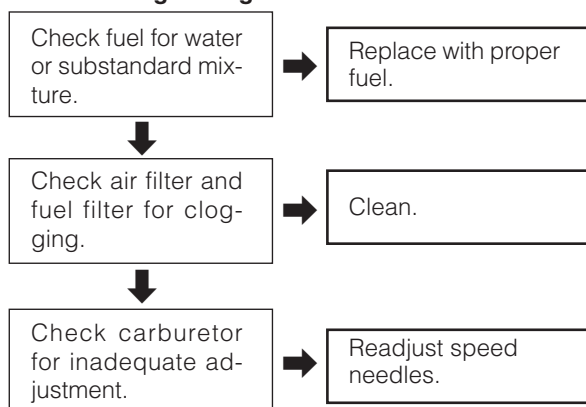

### Case 3. Oil does not come out

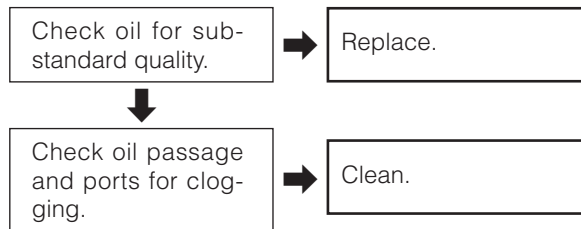

If the unit seems to need further service, please consult with an authorized service shop in your area.

## 10. Disposal

When disposing your machine, fuel or oil for the machine, be sure to allow your local regulations.

## 11. Specifications

### Power unit:

Displacement (cm<sup>3</sup>): ..... 62.0

Fuel: ..... Mixture (Gasoline 50 : Two-cycle oil 1)  
(when using ZENOAH genuine oil)

Fuel tank capacity (cm<sup>3</sup>): ..... 670

Chain oil: ..... Motor oil SAE# 10W-30

Oil tank capacity (cm<sup>3</sup>): ..... 350

Carburetor: ..... Walbro HDA type  
ignition system: ..... Pointless (CDI)

Spark plug: ..... NGK BPMR7A

Oil feeding system: ..... Automatic pump with adjuster  
Sprocket (Teeth x Pitch): ..... 7T x 3/8"

Dimensions (L x W x H) (mm): ..... 435 x 260 x 290

Dry weight

Power unit only (kg): ..... 5.6

### Cutting head:

Guide bar

Type: ..... Sprocket nose

Size (in. (mm)): ..... 16 (400), 18 (450), 20 (500)

Saw chain

Type: ..... Oregon 73LGX

Pitch (in. (mm)): ..... 0.375 (9.53)

Gauge (in. (mm)): ..... 0.058 (1.47)

Power (kw/min<sup>-1</sup>) ..... 2.89/9,500

Max speed (min<sup>-1</sup>) ..... 11,000

Idle speed (min<sup>-1</sup>) ..... 2,500

Specifications are subject to change without notice.



## Limited warranty

---

Should any failure occur on the product under normal operating conditions within the applicable warranty period, the failed part will be replaced or repaired free of charge by a ZENOAH authorized dealer.

**WARRANTY PERIOD:** 1 year (6 months if used professionally, and 30 days if used for rental purpose) from the date of initial purchase.

THE PURCHASER SHALL BEAR COSTS OF TRANSPORTING THE UNIT TO AND FROM THE ZENOAH DEALER.

THE PURCHASER SHALL NOT BE CHARGED FOR DIAGNOSTIC LABOR WHICH LEADS TO THE DETERMINATION THAT A WARRANTED PART IS DEFECTIVE, IF THE DIAGNOSTIC WORK IS PERFORMED AT THE ZENOAH DEALER.

THE PURCHASER OR OWNER IS RESPONSIBLE FOR THE PERFORMANCE OF THE REQUIRED MAINTENANCE AS DEFINED BY THE MANUFACTURER IN THE OWNER/OPERATOR MANUAL.

ANY WARRANTED PART WHICH IS NOT SCHEDULED FOR REPLACEMENT AS REQUIRED MAINTENANCE, OR WHICH IS SCHEDULED ONLY FOR REGULAR INSPECTION TO THE EFFECT OF REPAIR OR "REPLACE AS NECESSARY" SHALL BE WARRANTED FOR THE WARRANTY PERIOD. ANY WARRANTED PART WHICH IS SCHEDULED FOR REPLACEMENT AS REQUIRED MAINTENANCE SHALL BE WARRANTED FOR THE PERIOD OF TIME UP TO THE FIRST SCHEDULED REPLACEMENT POINT FOR THE PART.

ANY REPLACEMENT PART THAT IS EQUIVALENT IN PERFORMANCE AND DURABILITY MAY BE USED IN NON-WARRANTY MAINTENANCE OR REPAIRS, AND

SHALL NOT REDUCE THE WARRANTY OBLIGATION OF THE COMPANY.

THE COMPANY IS LIABLE FOR DAMAGES TO OTHER ENGINE COMPONENTS CAUSED BY THE FAILURE OF A WARRANTED PART STILL UNDER WARRANTY.

**THE WARRANTY DOES NOT APPLY TO** THOSE UNITS WHICH HAVE BEEN DAMAGED BY NEGLIGENCE OF INSTRUCTION LISTED IN THE OWNER/OPERATOR MANUAL FOR PROPER USE AND MAINTENANCE OF THE UNITS ACCIDENT MISHANDLING, ALTERATION, ABUSE, IMPROPER LUBRICATION, USE OF ANY PARTS OR ACCESSORIES OTHER THAN THOSE SPECIFIED BY THE COMPANY, OR OTHER CAUSES BEYOND THE COMPANY'S CONTROL.

**THIS WARRANTY DOES NOT COVER** THOSE PARTS REPLACED BY NORMAL WEAR OR HARMLESS CHANGES IN THEIR APPEARANCE.

**THERE ARE NO OTHER EXPRESS WARRANTIES.**

**IMPLIED WARRANTIES** INCLUDING THOSE OF MERCHANTABILITY AND FITNESS FOR A PARTICULAR PURPOSE **ARE LIMITED** TO TWO (2) YEARS OF HOME USE [ONE (1) YEAR FOR ANY OTHER USE] FROM THE ORIGINAL DELIVERY DATE.

**LIABILITIES FOR INCIDENTAL OR CONSEQUENTIAL DAMAGE UNDER ANY AND ALL WARRANTIES ARE EXCLUDED.**

IF YOU NEED TO OBTAIN MORE INFORMATION, PLEASE CALL YOUR NEAREST SERVICE CENTER, OR CHECK PLEASE ZENOAH WEB SITE <http://www.zenoah.net>