



OWNER'S MANUAL

MIST KIT FOR BLOWERS



MIST KIT FOR EBZ8000 EBZ8001



WARNING



 Before using our products, please read this manual carefully to understand the proper use of your unit.

▲ SAFETY FIRST

Instructions contained in warnings within this manual marked with a ▲ symbol concern critical points which must be taken into consideration to prevent possible serious bodily injury, and for this reason you are requested to read all such instructions carefully and follow them without fail.

WARNINGS IN THE MANUAL

▲ WARNING

This mark indicates instructions, which must be followed in order to prevent accidents, which could lead to serious bodily injury or death.

❗ IMPORTANT

This mark indicates instructions, which must be followed, or it leads to mechanical failure, breakdown, or damage.

📖 NOTE

This mark indicates hints or directions useful in the use of the product.

▲ WARNING

Never attach this mist kit to other than applicable models. Failure to do so may void your warranty.

APPLICABLE MODEL : EBZ8000, EBZ8001

Contents

1. Specifications	2
2. Warning labels on the machine	2
3. For safe operation	3
4. Set up	6
5. Operation	7
6. Maintenance	7
7. Storage	8
8. Disposal	8

1. Specification

This data is when the “Mist Kit” is mounted on EBZ8000, EBZ8001.

Model		Mist Kit for EBZ8000, EBZ8001	
Purpose		Spraying agricultural chemicals and cold water for pest control, weeding, and growth control	
Capacity of chemical fluid tank		liters	14
Pump	Longitudinal coverage	Horizontal m	22
		Vertical m	14
Maximum water absorption		liters / min.	5.5

Specifications are subject to change without notice.

2. Warning labels on the machine



Read owner’s manual before operating this machine.



Wear head, eye and ear protection.



Warning / Attention

Keep all children, bystanders and helpers 15 meters away from the machine.

❗ If warning label peels off or becomes soiled and impossible to read, you should contact the dealer from which you purchased the product to order new labels and affix them in the required location(s).

▲ **Never modify your machine. We won’t warrant the machine, if you use the remodeled blower or if you don’t observe the proper usage written in the manual.**

▲ 3. For safe operation

Before using this product, please read this Operator's Manual thoroughly to ensure correct operation. The following are precautions that should be observed in order to use the product smoothly. Elsewhere in the Manual, the ▲ warning mark is used to bring your attention to these precautions.



BEFORE USING THE PRODUCT

- This product has been designed mainly for the purpose of spraying pest control chemicals and weedkillers. Please do not use it for any other purpose, as this may cause unforeseen accidents.
- Since this product uses agricultural chemicals that require careful operation, misuse can be dangerous. Do not use this product when tired or otherwise in poor physical condition, or when you may be unable to judge correctly or operate accurately, such as after taking cold relief medicines or drinking alcohol. Also, children or persons who are unable to understand the contents of this Manual should under no circumstances be permitted to use the product.
- The engine exhaust gas contains toxic carbon monoxide. Please do not use the product indoors, in vinyl houses or tunnels, or in other poorly ventilated places.



- Do not use this product in the following cases.
 1. When the product could fall over or in other situations when it is difficult to hold or operate.
 2. After sunset or at other times when eyesight is poor and the safety of the spraying area is difficult to ascertain.
 3. In worsening weather (rain, fog, strong wind, lightning, etc.)
- When using for the first time, before commencing actual spraying please receive guidance in operating the product from a person with adequate experience.
- Fatigue reduces powers of concentration and increases the risk of accidents. When planning work, please allow ample time, setting a limit of 30-40 minutes for single spraying sessions and breaks of 10-20 minutes in between. Also, do not spray for more than 2 hours in any one day.
- Please take good care of this Operator's Manual and refer to it for additional information from time to time.
- When selling or lending this product, it should be accompanied by this Operator's Manual.

PRECAUTIONS BEFORE SPRAYING

- Make sure you have the correct protective clothing, headgear, rubber gloves and boots, a protective mask, goggles, a towel, protective cream, etc., to prevent chemicals from coming into contact with your skin or entering your lungs. When spraying, please wear this protective gear to prevent any risk of injury.

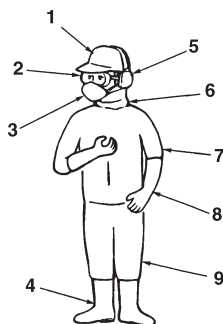

1. Protective headgear
2. Protective goggles
3. Protective mask
4. Rubber boots
5. Ear muffs
6. Neck covering
7. Protective clothing
8. Rubber gloves
9. Protective clothing

- Please store chemicals in a locked storage box, locker, or other safe place out of the reach of children.
- Carefully read the instructions for using the chemicals, and familiarize yourself with the level of toxicity, method of use, etc.
- Please pay all due consideration to the area in which you will be spraying, to ensure that you do not pollute the water supply, rivers, lakes, ponds, etc., or cause any damage to residents, passers-by, livestock, etc.
- Prepare yourself physically on the day before spraying, by for example cutting down on alcoholic beverages or late-night work.
- Do not allow children, animals, etc., to enter the chemical spraying area.



- Before spraying, please prepare fully by inspecting sprayer nozzles and checking for abnormalities such as loose screws or spray hose connections, fuel leaks, defective or broken fluid gaskets, or damage to the carrying band.

PRECAUTIONS WHEN TRANSPORTING CHEMICALS

- When transporting chemicals, please handle with care to ensure that there is no spillage of chemicals from torn bags, broken bottles, or loose stoppers.
- Do not carry chemicals in the same container as food.

PRECAUTIONS WHEN TRANSPORTING THE SPRAYER

- Do not transport the sprayer while it has chemicals or fuel in the tank, as these could leak out as a result

▲ 3. For safe operation

of impact during transportation.

- When transporting in a vehicle, please use a rope or similar to fix the sprayer firmly to the cargo trailer in an upright position. Please do not transport by bicycle or motorbike, as this is dangerous.

PRECAUTIONS CONCERNING FUEL

- The engine of this product is fueled by "mixed gasoline" that includes highly combustible fuel. Do not refuel or store fuel containers where there is any risk of combustion from incinerators, burners, bonfires, kitchen stoves, electric sparks, welding sparks, etc.



- Smoking while spraying or refueling is dangerous. Please avoid this at all costs.
- When refueling during use, always stop the engine and make sure there are no naked flames in the vicinity before refilling.
- Any fuel spilt during refueling should be wiped off completely with a rag or similar before starting the engine.
- After refueling, seal the fuel container, tightly close the fuel tank cap, and start the engine at least 3 meters away.

PRECAUTIONS WHEN REFILLING CHEMICALS

- Before filling the tank with chemicals, please make sure that the intermediate valve is closed.
- After chemical refilling, firmly tighten the tank cap. If not fully tightened the cap may become loose during spraying, with the risk of physical exposure to the chemicals.

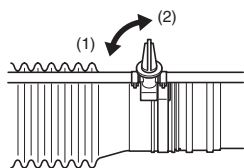

(1) OPEN
(2) CLOSE

- Do not fill chemicals over 14 liters.
- Do not mix different chemicals.
- Wash the chemical fluid tank and the nozzle cleanly when you change the type of chemical.

PRECAUTION WHEN STARTING THE ENGINE

- Please keep children, animals, etc. well away when starting the engine and spraying.

PRECAUTIONS WHEN SPRAYING

- Since protective clothing generally offers poor ventilation and thus places stress on the body, there is a risk of contracting heatstroke or other illness when operating for long periods under high temperatures. Please avoid spraying on hot days, aiming instead for early morning and late afternoon times when tem-

peratures are relatively cool and winds are low.

- When starting work, please pay all due consideration to the spraying time, wind direction, etc., to ensure that no noise disturbance or chemical hazard is caused to nearby residents, passers-by, farm crops, and so on.
- While spraying please hold the grip firmly at all times and be careful not to point the nozzle in the direction of people or animals.
- While spraying please be careful of the wind direction and always stand on the upwind side, to avoid spraying yourself with chemicals.
- Should you begin to feel even slightly unwell while spraying, consult a doctor immediately. When doing so, inform the doctor of the name of the chemical you were using, the conditions of use, etc.
- If the sprayer is tilted the chemical may leak out through the air holes in the cap. When spraying always make sure you have a firm footing and maintain your balance.
- Do not touch the spark plugs or plug cords while the engine is running, as you may get an electric shock.



- Do not touch the muffler, spark plugs, or other metal parts with your bare hands while the engine is running or immediately after stopping the engine, as there is the risk of burns due to high temperatures.

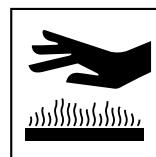

PRECAUTIONS AFTER SPRAYING

- Please seal unused chemicals and store them out of the reach of children.
- Do not simply discard empty chemical containers, but dispose of them safely by incinerating, burying, or another similar method. In addition, please take every care that the water used to clean spraying tools does not create any hazard.
- Fully inspect and maintain protective clothing, masks, gloves, and other protective gear in preparation for the next session.
- After completing the work and tidying away chemicals and spraying tools, you should immediately take a bath or wash your hands, feet, face, etc. thoroughly with soap, as well as washing your mouth out.
- You should change all clothes worn, including underwear, and wash them thoroughly. Clothes worn during spraying should not be worn again the following day.
- After spraying, please limit your alcohol intake and

▲ 3. For safe operation

rest thoroughly by going to bed early. If you feel even slightly unwell, please see a doctor as soon as possible.

OTHER PRECAUTIONS

- When engaged in spraying work over a protracted period of time, please have your health checked regularly.
- Please carry out spraying in a planned fashion, keeping a daily record of the date and time of spraying, the chemicals used, the target pest, contents of the work, duration of the work, and other details.
- Please keep the following points in mind when selecting or using protective gear.
 - a) Protective clothing
Choose clothing that is cool to wear and offers good ventilation and waterproofing. In addition, wear items that enable you to carry out spraying work in total comfort and safety.
 - b) Spraying hood
Use a hood with a brim that is waterproof and covers your neck and shoulders.
 - c) Gloves
Use gloves that are difficult for chemicals to penetrate and do not slip even if you perspire while doing the work.
 - d) Rubber apron
When mixing chemicals, wear a long, thick, and wide apron that cannot be penetrated by chemical splashes.
 - e) Protective goggles, mask, etc.
Select suitable protective goggles, mask, rubber boots, eye washer, and protective cream, etc., paying attention to standards and the recommendations of farm work safety promotion organizations.



MAINTENANCE PRECAUTIONS

- In order to maintain the functions of the product, regularly carry out the maintenance inspections listed in this Manual. When maintenance or parts replacement not indicated in this Manual are required, please consult your product supplier or nearest ZENOAH product dealer.
- Never keep the engine running while carrying out inspections or maintenance.
- Do not modify the sprayer or dismantle the engine. This could lead to breakdown and serious accidents during operation.
- Do not touch the muffler or spark plugs with your bare hands immediately after stopping the engine. There is the risk of burns due to high temperature.

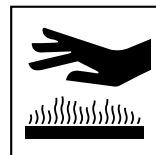

- For replacement parts, please use original ZENOAH parts or brands designated by ZENOAH.

MAINTENANCE OF LABELS

1. Please keep warning labels clean and unmarked.
2. If warning labels become soiled or peel off, please order from your supplier and replace with new ones.
3. When affixing new labels please wipe off all dirt and moisture.

4. Set up

COMPONENTS (pcs.)

- (A) Tank Ass'y 1
- (B) Valve Ass'y 1
- (C) Mist Nozzle Ass'y.. 1
- (D) Frame 1
- (E) Plate 1
- (F) Plate 2
- (G) Plate 2
- (H) Spacer 1
- (I) Pipe 1
- (J) Screw 5 x 14 4
- (K) Screw 5 x 20 2
- (L) Screw 5 x 25 6
- (M) Tube 1
- (N) Clip 4
- (O) Clamp 1

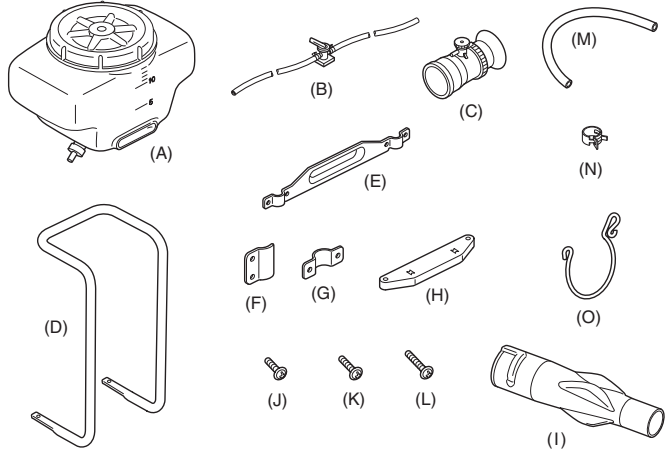

ASSEMBLY

1. Remove the back pad from the back plate.

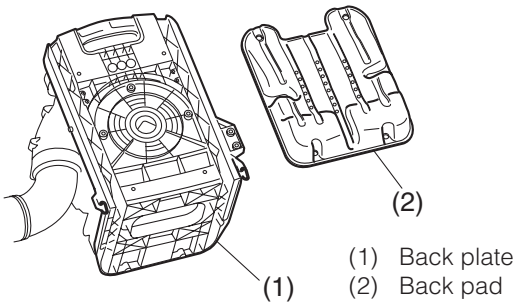

- 2. Fit frame (D) in the groove of the back plate, and fasten it with 2 plates (G) and 6 screws (L).
- 3. Fasten the spacer (H) with 2 screws (K).
- 4. Replace the back pad.

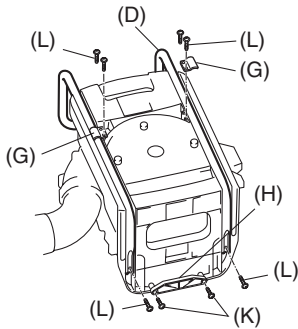

- 5. Set the tank (A) as shown in the picture, and fasten it with the plate (E), 2 plates (F) and 4 screws (J).
- 6. Connect the tube (M) to the volute and tank (A), and fasten it with 2 clips (N).

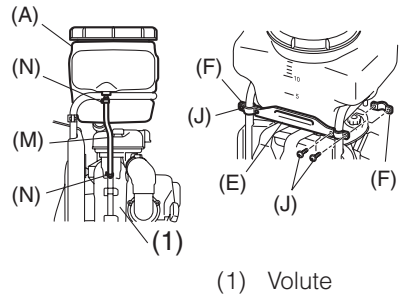

- 7. Connect the mist nozzle ass'y (C) with the pipe (I).
- 8. Connect the valve ass'y (B) to the tank (A) and mist nozzle ass'y (C), and fix them with 2 clips (N).

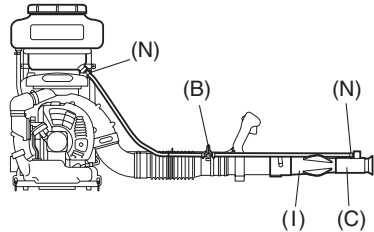

TIGHTENING TORQUE
3.5 ± 0.5 N·m

5. Operation

HOW TO USE

1. Pour the solution into the tank with the intermediate valve closed.

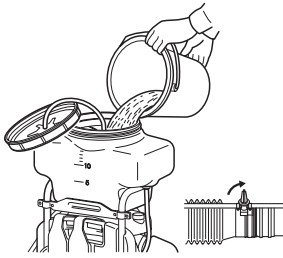

Valve travel	Discharge rate (lit/min.)
1	1.0
2	2.1
3	3.8
4	5.5

Max. Longitudinal coverage

Horizontal direction :	22 m
Vertical direction :	14 m

⚠ WARNING

- Do not fill chemicals over 14 liters.
 - Do not mix different chemicals.
2. Adjust the solution flow and the spray range according to work conditions.

The solution flow is changed by shifting the number on the top of the valve at the mist nozzle. The figure shows 5.5 lit/min. position.

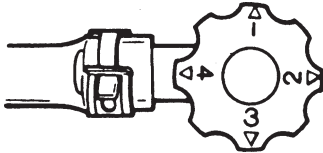

The spray range is changed by shifting the bell position after loosening the lock ring.

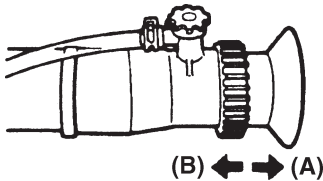

- (A) Pulled out position: Long distance, narrow angle spray
 (B) Pushed In position: Short distance, wide angle spray

3. Start the engine and carry the unit on your back.
4. While holding the swivel joint in your right hand, move the throttle lever upward and turn the intermediate valve to the open position.
5. After spraying work has finished, close the intermediate valve and stop the engine.

⚠ WARNING

- Before the solution spraying work, supply water into the tank and operate the mister to make sure that there is any leakage or any mechanical failure.
- Repair it if there is any leakage or failure before the solution spraying work.

6. Maintenance

⚠ WARNING

Make sure that the engine has stopped and is cool before performing any service to the blower. Contact with rotating blower fan or hot muffler may result in a personal injury.

- Use only ZENOAH replacement parts. Failure to do so may cause poor performance, possible injury and may void your warranty.
- Inspect unit before each use for loose fasteners, leaks, etc. Replace damaged parts.

7. Storage

On completion of all work procedures, when not planning to use again for a protracted period please carry out the following pre-storage care, to prevent trouble caused by time-lapse changes.

1. Clean the chemical fluid tank and nozzle.
2. Remove dirt from the sprayer, inspect it for any damage or looseness, and, if any abnormality is found, correct it thoroughly in preparation for the next time you use the unit.
3. Drain the fuel tank.
4. Start the engine, and leave it in idling condition until all the fuel inside the carburetor is spent and the engine comes to a natural stop.

5. Remove the spark plug and put a few drops (1~2 cc) of 2-cycle oil inside the engine. After pulling the starter rope 2 or 3 times, return the spark plugs to their original position and stop in compressed position.
6. After oiling the throttle lever and other metal parts with anti-corrosive oil, cover the sprayer and store indoors in a low-humidity location.

8. Disposal

When disposing your machine, fuel or oil for the machine, be sure to allow your local regulations.

Limited warranty

Should any failure occur on the product under normal operating conditions within the applicable warranty period, the failed part will be replaced or repaired free of charge by a ZENOAH authorized dealer.

WARRANTY PERIOD: 1 year (6 months if used professionally, and 30 days if used for rental purpose) from the date of initial purchase.

THE PURCHASER SHALL BEAR COSTS OF TRANSPORTING THE UNIT TO AND FROM THE ZENOAH DEALER.

THE PURCHASER SHALL NOT BE CHARGED FOR DIAGNOSTIC LABOR WHICH LEADS TO THE DETERMINATION THAT A WARRANTED PART IS DEFECTIVE, IF THE DIAGNOSTIC WORK IS PERFORMED AT THE ZENOAH DEALER.

THE PURCHASER OR OWNER IS RESPONSIBLE FOR THE PERFORMANCE OF THE REQUIRED MAINTENANCE AS DEFINED BY THE MANUFACTURER IN THE OWNER/OPERATOR MANUAL.

ANY WARRANTED PART WHICH IS NOT SCHEDULED FOR REPLACEMENT AS REQUIRED MAINTENANCE, OR WHICH IS SCHEDULED ONLY FOR REGULAR INSPECTION TO THE EFFECT OF REPAIR OR "REPLACE AS NECESSARY" SHALL BE WARRANTED FOR THE WARRANTY PERIOD. ANY WARRANTED PART WHICH IS SCHEDULED FOR REPLACEMENT AS REQUIRED MAINTENANCE SHALL BE WARRANTED FOR THE PERIOD OF TIME UP TO THE FIRST SCHEDULED REPLACEMENT POINT FOR THE PART.

ANY REPLACEMENT PART THAT IS EQUIVALENT IN PERFORMANCE AND DURABILITY MAY BE USED IN NON-

WARRANTY MAINTENANCE OR REPAIRS, AND SHALL NOT REDUCE THE WARRANTY OBLIGATION OF THE COMPANY.

THE COMPANY IS LIABLE FOR DAMAGES TO OTHER ENGINE COMPONENTS CAUSED BY THE FAILURE OF A WARRANTED PARTS STILL UNDER WARRANTY.

THE WARRANTY DOES NOT APPLY TO THOSE UNITS WHICH HAVE BEEN DAMAGED BY NEGLIGENCE OF INSTRUCTION LISTED IN THE OWNER/OPERATOR MANUAL FOR PROPER USE AND MAINTENANCE OF THE UNITS ACCIDENT MISHANDLING, ALTERATION, ABUSE, IMPROPER LUBRICATION, USE OF ANY PARTS OR ACCESSORIES OTHER THAN THOSE SPECIFIED BY THE COMPANY, OR OTHER CAUSES BEYOND THE COMPANY'S CONTROL.

THIS WARRANTY DOES NOT COVER THOSE PARTS REPLACED BY NORMAL WEAR OR HARMLESS CHANGES IN THEIR APPEARANCE.

THERE ARE NO OTHER EXPRESS WARRANTIES.

IMPLIED WARRANTIES INCLUDING THOSE OF MERCHANTABILITY AND FITNESS FOR A PARTICULAR PURPOSE **ARE LIMITED** TO TWO (2) YEARS OF HOME USE [ONE (1) YEAR FOR ANY OTHER USE] FROM THE ORIGINAL DELIVERY DATE.

LIABILITIES FOR INCIDENTAL OR CONSEQUENTIAL DAMAGE UNDER ANY AND ALL WARRANTIES ARE EXCLUDED.

IF YOU NEED TO OBTAIN MORE INFORMATION, PLEASE CALL YOUR NEAREST SERVICE CENTER, OR CHECK PLEASE ZENOAH WEB SITE <http://www.zenoah.net>