



Shuttle® Brewer & Airpot/Shuttle® Brewers

Operation and Instruction Manual

For Models APB-330V2, APB-430V2, APBVSA-330V2, APBVSA-430V2, APBIC-330V2, APBIC-430V2, APB-330V2E230, APB-430V2E230, APBVSA-330V2E230, APBVSA-430V2E230, APBIC-330V2E230, PBIC-430V2E230

Table of Contents

Warning Labels	3
Installation and Start-up	4
Operation	6
Adjustments	7
Programming	8
Cleaning	16
Service	17
Troubleshooting	
Error Messages	20
Filling Problems	20
Heating Problems	22
Brewing Problems	24
Precision Brew® Control Board	26
Parts List	27
Parts Photos	28
VS-1.5(S) Cleaning and Sanitizing	32
Wiring Diagrams	33



**Models APB-330V2/
APB-330V2E230**



**Models APBIC-430V2/
APBIC-430V2E230**



**Models APBVSA-430V2/
APBVSA-430V2E230**

Prior authorization must be obtained from Grindmaster-Cecilware for all warranty claims.



Grindmaster-Cecilware

4003 Collins Lane
 Louisville, KY 40245 USA
 (502) 425-4776
 (800) 695-4500 (USA & Canada only)
 (800) 568-5715 (Technical Service Only)
 FAX (502) 425-4664
www.grindmaster.com

Warning Labels

The following warning labels were on your dispenser when it was shipped from the factory. They should remain on your dispenser in good, readable condition at all times. If one of your labels is missing or damaged, order a replacement label immediately.

Part # A546-445

Located on front splash panel and lid of machine.

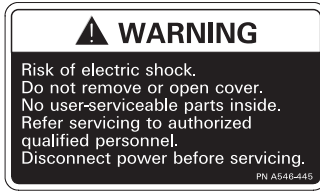

Located on APB-330V2, APB-330V2E230, APB-430V2, and APB-430V2E230 lower front decal.

Order part # A546-434 for APB-330V2.

Order part # A546-435 for APB-430V2.

Located on APBIC-330V2, APBIC-330V2E230, APBIC-430V2, and APBIC-430V2E230 above faucet.

Order part # A546-428 for APBIC-330V2.

Order part # A546-427 for APBIC-430V2.



Part # A546-213

Located on front splash panel.



Part # A71949

Located on brew baskets.



Installation



WARNING

ELECTRIC SHOCK HAZARD!

Installation of this appliance should be performed by qualified service personnel only. Improper installation could result in electrocution.

Set-Up/Position

- 1) Remove the brewer from the packing material and attach its legs.
- 2) Position the brewer on a strong, stable table or counter. Check the level front to back and side to side. Adjust the legs to the correct level.

IMPORTANT:

THE PERSON INSTALLING THIS APPLIANCE IS RESPONSIBLE FOR ENSURING THAT ELECTRIC AND WATER CONNECTIONS MEET THE REQUIREMENTS OF THE NATIONAL ELECTRIC CODE, NATIONAL PLUMBING CODE, AND ANY LOCAL ORDINANCES.

The electric and water hook-up locations are behind the front panel. Remove the four screws fastening this panel for access to these connections.

Water Hook-up

- 1) The water line may enter through holes on the rear or the bottom of the brewer. Use the right hand opening for water.
- 2) Use 3/8" copper or flexible water line to prevent strain. Do not use low temperature plastic tubing. The connection to the fill valve is 3/8" flare.
- 3) Water line pressure must be from 30 to 80 psi (207-2 KPA).
- 4) Hot (up to 160°F/71°C) or cold water may be used. Hot water offers faster recovery between brews.
- 5) Install a shut-off valve near the brewer.
- 6) Installing a filtering system can improve the taste of brewed coffee and extend the life of the brewer. If your water has high calcium (lime), chlorine, or iron content, this is especially important. The filter should be the lime inhibiting type if cold water is used.

Installation (cont.)

Electric Hook-up

The brewer is designed to operate at the specified voltage on the nameplate with a tolerance of $\pm 10\%$ for voltage deviation. It is very important that the power line to the brewer be checked to make sure that the voltage is within 10% of the brewer's rated voltage. Failure to provide adequate voltage, as defined above, will cause problems with your brewer. If the power is too low, the solenoid valves may or may not work or longer recovery time will be experienced. The brewer may be permanently damaged if the voltage is too high.

- 1) The electric ratings for your brewer are printed on its nameplate.
- 2) The brewer should be connected to its own circuit with a fused disconnect switch or a circuit breaker near the brewer.

Important: For CE units, means shall be provided to endure all pole disconnection from the supply. Such means shall be one of the following: a supply cord fitted with plug, or a switch that is directly connected to the supply terminals and has a contact separation of at least 3mm in each pole.

- 3) Attach the appropriately sized cord to the brewer with a cord grip for the 1 1/2" (3.8 cm) electric input opening. The cord may enter through the rear or bottom on the left side of the brewer. Use an oil resistant cord such as type SO, SOO, SAO, STOO, SEO, SJO, SJOO, SJTO, SJTOO, SJEO, HSO, HSOO, HSJO, or HSJOO. Alternatively, flexible conduit and type THHN wires may be used. Use only copper conductors.
- 4) Standard connection is 1 phase 3 wire. Connect the two lines to L1 and L2 on the terminal block. If the brewer is wired for three phase, a lug, L3, is provided on the terminal block. Neutral line should be connected to the N terminal. Alternately, if no neutral is available, the brewer can be wired accordingly by connecting L1 to position marked "L1" and L2 to position marked "L2". This will require the installer to change the connection to the transformer primary from the white wire (120V) to the blue (208V) or orange (230,240V) connection. See below.

NOTE: This "no neutral" conversion is only applicable to units marked as 208V, 230V, or 240V. It is NOT applicable to units marked 120/208V or 120/240V.

Note: The brewer utilizes a multiple tap primary transformer to convert line voltage to 24 volts for use by the controller and some operating controls. The transformer has taps for 120V (white wire), 208V (blue wire), and 240V (orange wire) line voltage. Be sure to connect the white wire from the terminal block to the proper tap for the supplied voltage. See diagram below.

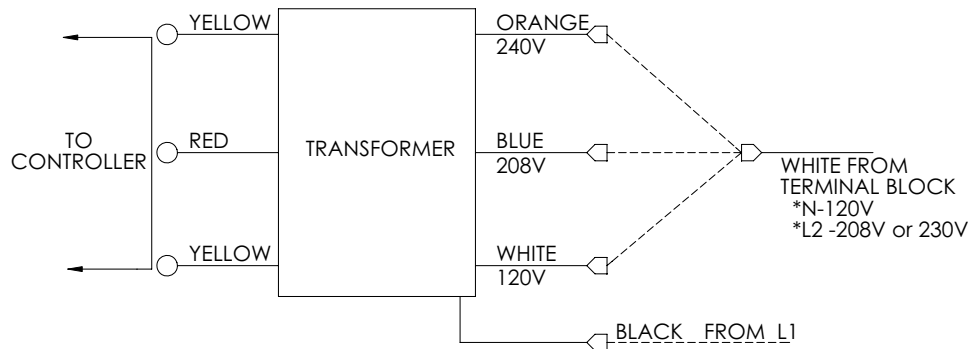

- 5) The body of the brewer must be grounded. A ground lug is provided for this purpose.

Note: If supply cord is damaged, it must be replaced by a special cord or assembly from the manufacturer, or it's service agent.

Note: This appliance is IP10 rated, and shall not be cleaned with a water jet.



WARNING

Never use the ground conductor as a neutral. This could cause electrocution.

Installation (cont.)

Start-up

- 1) Flip power supply to machine “ON” at the branch supply disconnect and allow the water tank to fill. The machine will make a subtle hissing sound while filling.

Attention: A watchdog circuit monitors the fill valve “ON” time. If the “ON” time exceeds 6 minutes continuously, the brewer will display message “ER1” and cease operation. Normal initial fill time on some models exceeds 6 minutes. Turn off power to brewer and turn back on; this will reset the controller and allow brewer to complete filling.

- 2) Once the brewer is full, it will take 15 to 35 minutes to heat. The ready lights will turn on when up to temperature.
- 3) Insert the brew baskets and place a Shuttle or airpot under the baskets. Brew at least one batch from each side. Check the level in the container to be sure the brew volume is correct. Remember that when using coffee, the level will be lower. Do this for all batch sizes. The water must be hot to check the levels. If adjustments are needed, see the adjustments section of this manual.

Operation



HOT LIQUID HAZARD!

Water used for brewing coffee is very hot. Use caution when brewing, pouring, or transporting coffee. Accidental spills may result in severe burns.

- 1) Place an empty, warm Shuttle on the shelf, under the brew head. Turn on the warmer if available.
- 2) If the Shuttle is not warm, allow the warmer to heat the Shuttle. Only a short brew of water will speed this. A cold Shuttle will significantly lower the temperature of the brewed coffee.
- 3) Remove the filter basket and line with a filter paper. Paper size is 13 x 5 for the smaller basket, BB1.5, and 14 x 6 for the larger, BB2.0.
- 4) Place ground coffee in the filter basket. Follow corporate recommendations for amount of coffee and grind. A full Shuttle is 1.5 gallons (5.7L). A full vacuum Shuttle is 1.6 (6.0L) gallons.
- 5) Slide the basket into the brewer making sure the spout lines up with the top of the Shuttle.
- 6) If ready lights are lit, press correct batch size button.
- 7) Brew spray time is about 4 minutes for a full Shuttle. After the brew, allow the coffee to drip for 1 to 2 minutes. Ready light will flash during the entire brew spray and drip cycle. Brew basket will be locked in place until drip cycle is finished.



Coffee basket contains very hot water until the drip is completed. Early removal of a dripping basket could result in burns.

- 8) Dump the grounds from the basket and rinse for the next brew. Coffee is ready to serve.
- 9) The Shuttle may be placed on remote warming stations. Use caution when moving a full Shuttle.

Adjustments

All adjustments to machine are accessible through the front display(s). Refer to specifics below and the Programming Routine section. All values are preset at the factory and may vary brewer to brewer.

Temperature Adjustment

Tank temperature can be adjusted from 170°F – 205°F (77°C – 96°C) through the front display. See Programming Routine section for procedure.

This brewer can be set for maximum water temperature of 205°F (96°C). The boiling point of water is lower as altitude increases. The setpoint temperature of the brewer should be maintained below the boiling point at a given elevation. Refer the to the chart below for recommended maximum setpoint for given altitudes.

Altitude (ft)	Approximate Boiling Point		Recommended Max. Temperature	
	°F	°C	°F	°C
0	212	100	205	96.1
500	211.1	99.5	204	95.6
1000	210.2	99.0	203	95.0
1500	209.3	98.5	202	94.4
2000	208.4	98.0	201	93.9
2500	207.5	97.5	200	93.3
3000	206.6	97.0	199	92.8
3500	205.7	96.5	199	92.8
4000	204.8	96.0	198	92.2
4500	203.9	95.5	197	91.7
5000	203	95.0	196	91.1
5500	202	94.4	195	90.6
6000	201.1	93.9	194	90.0
6500	200.2	93.4	193	89.4
7000	199.3	92.9	192	88.9
7500	198.3	92.4	191	88.3

THERMISTOR CURVE FOR PART # A725-097						
°C	°F	RESISTANCE (OHMS)		°C	°F	RESISTANCE (OHMS)
0	32	16325		60	140	1244
5	41	12697		65	149	1041
10	50	9951		70	158	875
15	59	7856		75	167	740
20	68	6246		80	176	628
25	77	5000		85	185	535
30	86	4028		90	194	458
35	95	3266		95	203	393
40	104	2663		100	212	339
45	113	2185		105	221	294
50	122	1802		110	230	255
55	131	1493				

Adjustments (cont.)

Brew Volume “br”

Brew time can be set for each size visually. See Setting Brew Volume Procedure below.

Brew time can also be adjusted through the display. See Programming Routine section.

Setting Brew Volume Visually

1. Remove brew basket and place container under brew head.
2. Press and hold desired brew button for 5 seconds. Display will read “Pro”.
3. Within 20 seconds, press and release desired brew button. Water will dispense from spray head and time will count-up in display.
4. When volume is at desired amount, press and release brew button to stop flow. Time will flash in display.
5. Within 20 seconds, press and release desired brew button. Display will clear and brew time will be stored into memory.

Note: During this routine, no pulsing or bypass will occur.

Note: If the On/Off button is pressed during procedure, time setting will default to previous time.

Control Features

Pre-infusion: Controls the initial coffee grounds wetting and the first dwell time after the initial wetting. Pulse brews are the series of pulses after the Pre-infusion process. All pulse ON and OFF times are the same.

Brew Countdown Timer: After the start of a brew the LED display will countdown the remaining time left in the brew process. The countdown will include all OFF periods programmed in the Pre-infusion and the pulses. At the end of the brew time, the display will scroll **driP**, while the brew basket drains itself. At the end of the drip cycle, the display will scroll **doneE** for 30 seconds then turn off.

Energy Savings Mode: If enabled, when the brewer is idle for three (3) hours this feature will allow the water tank to lower its holding temperature to 120°F. The display will scroll **SLEEPing** while in this mode.

Copy-to-Left: On twin brewers, this feature allows you to copy the brew parameters programmed on a particular brew portion on the Right side to the Left side.

Programming

On twin brewers, the right side, Large portion button gives the user access to the global programming parameters of the brewer, such as; Tank Temperature, Energy Savings Mode, Enable/Disable Low Temp No Brew, ON/OFF, Drip Time and Bypass Ratio. After the global parameters are set, the individual portion brew parameters can be set. All other portion sizes (left and right) only access individual brew parameters to that particular portion. Also, on twin brewers, the last program step in programming individual brew parameters allows the operator to copy those brew parameters to the left side if “YES” is selected. If “YES” is selected, the brew parameters that were set for the right side for that particular portion are copied to the left side. If “NO” is selected, then the left side must be programmed separately.

To enter program mode:

Press the UP and DOWN arrows simultaneously for 5 seconds. Once in program mode, the green LED for each portions size will flash.

Programming (cont.)

To program the following items, press the **Large, Right side portion button**. (refer to Table 1)

- 1) Temperature Scale: Choose °F or °C
- 2) Set Water Tank Temperature: Choose between **170°F - 205°F**
- 3) **EnErGy mOdE**: Choose **YES** or **NO**
- 4) **Ltn** (Low Temp No Brew): Choose **YES** or **NO**
 - If **YES**, the brewer will only allow a brew to begin if the water tank temperature is within 5°F of set point.
 - If **NO**, the brewer will brew at any temperature.
- 5) **DriP time**: Choose from **40%** to **80%** of brew time.

This is the amount of time the brewer takes to completely drain the brew basket after the brew valve closes. The factory default is 50%, so if the brewer is set for a 1.5 gallon brew, without pre-infusion and pulses, the brew basket will remain locked for 2 minutes after the brew valve closes. If, with coffee, the brew basket drips for longer than 2 minutes, increase the setting to 60% which will be 2:24 of drip time. The setting increases by 5% increments; 12 seconds each.
- 6) **rto** (Set Bypass Ratio): Choose **Std** or **Grm**
 - Choose **Std** if you are using the standard sprayhead.
 - Choose **Grm** if you are using the gourmet sprayhead.

Bypass ratio is the last global program parameter to be set. The following are the individual brew portion parameters. Each portion button can have individual brew sequences.

- 7) **Br time** (Brew time): Choose between **0:01** to **6:00** minutes.

This time setting controls the brew volume. The brewer brews at a rate of 1.5 gallons in four minutes (48 ounces per minute / 0.8 ounces per second). The Large portion button is factory set to brew 1.5 gallons or 4 minutes of brew time. Adjust the brew volume to desired level. One second of brew time will change brew volume by 0.8 ounces.
- 8) **PrE inFuSion**: Choose **OFF** to **2:00** minutes.

This is the amount of pre-infusion desired with the batch of coffee. If no pre-infusion is desired then set to **OFF**.
- 9) **PrE inFuSion oFF**: Choose **0.05** to **2:00** minutes.

This is the OFF time that allows the brew basket to drain the Pre-infused volume of water.
- 10) **PuLSE br**: Choose **OFF** to **10**

This will set the number of brew pulses desired. If none are desired, then set to **OFF**.
- 11) **PuLSE on** (Pulse ON time): Choose **0:05 - 2:00** minutes
If pulses are set to 10, program the ON time for the pulses. The same ON time is used on all pulses.
- 12) **PuLSE oFF** (Pulse OFF time): Choose **0:05 - 2:00** minutes
If pulses are set on step 10, then program the OFF time for the pulses. The same OFF time is used on all pulses.

Programming (cont.)

- 13) **By-PASS** (Set bypass volume): Choose **OFF** to **25%**
Set the amount of bypass desired during brew. If none is desired then set to OFF, otherwise, set the % of brew volume to bypass.
- 14) **CoPY-to-LEFT**: Choose **YES** or **no**
If the same program parameters are desired on same portion size on the left side, then choose **YES** and the parameters will be copied.

The sequence of programming for the **Medium** portion is as follows: (refer to Table 2)

- 1) **Br time** (Brew time): Choose **0:01 - 6:00** minutes
- 2) **PrE inFuSion**: Choose **OFF** to **2:00** minutes
- 3) **PrE inFuSion oFF**: Choose **0:05** to **2:00** minutes
- 4) **PuLSE br** (Pulse Brewing): Choose **OFF** to **10**
- 5) **PuLSE on** (Pulse ON time): Choose **0:05 - 2:00** minutes
- 6) **PuLSE oFF** (Pulse OFF time): Choose **0:05 - 2:00** minutes
- 7) **By-PASS** (Set bypass volume): Choose **OFF - 25%**
- 8) **CoPY-to-LEFT**: Choose **YES** or **no**









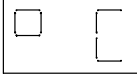
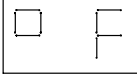

The sequence of programming for the **Small** portion is as follows: (refer to Table 3)

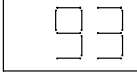
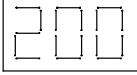
- 1) **Br time** (Brew time): Choose **0:01 - 6:00** minutes
- 2) **PrE inFuSion**: Choose **OFF** to **2:00** minutes
- 3) **PrE inFuSion oFF**: Choose **0:05** to **2:00** minutes
- 4) **PuLSE br** (Pulse Brewing): Choose **OFF** to **10**
- 5) **PuLSE on** (Pulse ON time): Choose **0:05 - 2:00** minutes
- 6) **PuLSE oFF** (Pulse OFF time): Choose **0:05 - 2:00** minutes
- 7) **CoPY-to-LEFT**: Choose **YES** or **no**

Programming Sequence for Large Left Portion

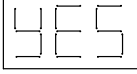
Table 1



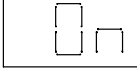









**PRESS-AND-HOLD UP & DOWN ARROWS FOR 5 SECONDS.
DISPLAY WILL READ AS FOLLOWS:**

	DISPLAY READING	ADJUST	ADVANCE
TEMP SCALE	°C OR °F	△ ▽	
TANK TEMP (170-202F)	93 OR 200	△ ▽	
ENERGY MODE	ENERGY mode		
ENERGY MODE	YES OR no	△ ▽	
LOW-TEMP/NO-BREW	letn		
LOW-TEMP/NO-BREW	On OR OFF	△ ▽	
DRIP TIME	drip time		
DRIP TIME PERCENT OF BREW	.40 TO .80	△ ▽	
BYPASS RATIO	rto		
	Std OR Grnn	△ ▽	
BREW TIME	br time		
BREW TIME (.01 TO 6.00)	4.00	△ ▽	
PRE INFUSION	PRE infusion		
PRE INFUSION TIME (OFF TO 2.00)	OFF TO 2.00	△ ▽	

continued on next page

Programming Sequence for Large Left Portion (cont.)















Table 1 (cont.)

	DISPLAY READING	ADJUST	ADVANCE
PRE INFUSION	PrE infuS ion off		
PRE INFUSION OFF TIME (.05 TO 2.00)	. 9 TO 2.00	△ ▽	
PULSE BREW	PuLSE br	△ ▽	
# OF PULSES (OFF, 1 - 10)	OFF TO 10	△ ▽	
PULSE ON	PuLSE on		
PULSE ON TIME (0:05-2:00)	.20	△ ▽	
PULSE OFF	PuLSE off		
PULSE OFF TIME (0:05-2:00)	.20	△ ▽	
BY-PASS	by-PASS		
OFF TO .25 PERCENT	OFF TO .25	△ ▽	
COPY TO LEFT	CoPY-to-LEFt		
	YES OR no	△ ▽	

Programming Sequence for Medium Portions

Table 2

**PRESS-AND-HOLD UP & DOWN ARROWS FOR 5 SECONDS.
DISPLAY WILL READ AS FOLLOWS:**





	DISPLAY READING	ADJUST	ADVANCE
BREW TIME	br t innE		
BREW TIME (.01 TO 6.00)	4.00	△ ▽	
PRE INFUSION	PrE infuS ion		
PRE INFUSION TIME (OFF TO 2.00)	OFF TO 2.00	△ ▽	
PRE INFUSION	PrE infuS ion off		
PRE INFUSION OFF TIME (.05 TO 2.00)	. 5 TO 2.00	△ ▽	
PULSE BREW	PuLSE br	△ ▽	
# OF PULSES (OFF, 1 - 10)	OFF TO 10	△ ▽	
PULSE ON	PuLSE on		
PULSE ON TIME (0:05-2:00)	.20	△ ▽	
PULSE OFF	PuLSE off		
PULSE OFF TIME (0:05-2:00)	.20	△ ▽	
BY-PASS	by-PASS		
OFF TO .25 PERCENT	OFF TO .25	△ ▽	

continued on next page

Programming Sequence for Medium Portions (cont.)

Table 2 (cont.)















PRESS-AND-HOLD UP & DOWN ARROWS FOR 5 SECONDS.
DISPLAY WILL READ AS FOLLOWS:

	DISPLAY READING	ADJUST	ADVANCE
COPY TO LEFT	COPY-TO-LEFT		
	YES OR NO	 	

Programming Sequence for Small Portions

Table 3

**PRESS-AND-HOLD UP & DOWN ARROWS FOR 5 SECONDS.
DISPLAY WILL READ AS FOLLOWS:**

	DISPLAY READING	ADJUST	ADVANCE
BREW TIME	br t innE		
BREW TIME (.01 TO 6.00)	4.00	△ ▽	
PRE INFUSION	PrE infuS ion		
PRE INFUSION TIME (OFF TO 2.00)	OFF TO 2.00	△ ▽	
PRE INFUSION	PrE infuS ion off		
PRE INFUSION OFF TIME (.05 TO 2.00)	. 5 TO 2.00	△ ▽	
PULSE BREW	PuLSE br	△ ▽	
# OF PULSES (OFF, 1 - 10)	OFF TO 10	△ ▽	
PULSE ON	PuLSE on		
PULSE ON TIME (0:05-2:00)	.20	△ ▽	
PULSE OFF	PuLSE off		
PULSE OFF TIME (0:05-2:00)	.20	△ ▽	
COPY TO LEFT	CoPY-to-LEft		
	YES OR no	△ ▽	

Cleaning



Burn Hazard!

Hot liquids and surfaces are present in this equipment. To avoid burns use caution when cleaning. Rinse hot parts with cold water before cleaning. Use gloves or a heavy cloth when removing hot parts from brewer.

After Each Brew:

- 1) Dispose of grounds and rinse brew basket.
- 2) Rinse Shuttle or airpot containers before reuse.

Every Day:

- 1) Wash brew basket with warm soapy water. The wire basket is removable to aid cleaning.
- 2) Remove spray head(s), located above brew basket(s), using gloves or a heavy towel. Wash off coffee oils and clean any plugged holes.
- 3) Clean Shuttles with warm soapy water and a brush or towel.
- 4) Use only a soft cloth and warm soapy water or stainless steel polish on the outside to avoid scratches.
- 5) Wipe exterior of brewer with a damp cloth. Do not use abrasives which will scratch surface.
- 6) If Shuttles are to be left on warmer all night, fill with water to avoid coffee oil burn-in.

Weekly or Bi-Weekly, Depending on Use

- 1) Fill Shuttles with one gallon, 2/3 full, of hot water.
- 2) Pour into the Shuttle liners the recommended concentration of urn cleaner (excessive amounts of cleaner will attack the stainless steel).

Urn cleaners that have been used successfully:

DIP-IT
manufactured by Reckitt Benckiser, Inc.
1655 Valley Road
Wayne, NJ 07474
(800) 228-4722 or (973) 633-3600

TABZ™ Super Concentrate
manufactured by Urnex Brands, Inc.
170 Ludlow Street
Yonkers, NY 10705
(800) 222-2826 or (914) 963-2042

- 3) Scrub the liner interior with a plastic bristle brush.
- 4) Remove the knurled nut at the top of the gauge glass and clean the glass with a small bottle brush.
- 5) Pour out the contents of the Shuttle.
- 6) Remove the handle assembly of the Shuttle faucet by unscrewing the plastic bonnet.
- 7) Gently wash the faucet seat cup with a soft cloth and warm soapy water.
- 8) Wash the faucet shank with a bottle brush.
- 9) Soak airpot pick-up tube assembly in hot soapy water. Urn cleaner may be used for stronger cleaning.
- 10) Clean the warmer and bottom of Shuttle surfaces. These surfaces must be clean for proper heat transfer.
- 11) Polish the exterior of the brewer with stainless steel cleaner. Use the appropriate cleaner for brass, copper, or vinyl if these optional finishes are provided.

Service

The rest of this manual contains information to aid the service person who is working on this equipment. This page has information on performing *common service tasks*. Following this is the *Troubleshooting* section which can help diagnose problems which are divided into three basic systems: filling, heating, and brewing.

Next is an *illustrated parts breakdown* which will help in the selection of repair parts. If further assistance is needed, call our Technical Service Department at **800-695-4500** (USA & Canada only) or (502) 425-4776 Monday – Friday between 8:00 am and 6:00 pm Eastern time.

Wiring diagrams are also provided. Locate the basic diagram for the model you are working with. If there are any options, see Diagram #091-548 (page 33 of this manual) which shows the wiring alterations for options.

Drain Water Tank

Always empty the tank before shipping.



Draining of tank should be performed by a qualified service technician. The tank contains very hot water. May cause severe burns.

Note: Brewer may contain over 5 gallons (19.0L) of hot water.

- 1) Prepare a heat resistant container to drain tank water into.
- 2) Disconnect power to the brewer.
- 3) Remove the front access panel.
- 4) Pinch or clamp the silicone hose connected to fill valve.
- 5) Disconnect hose from outlet barb on fill valve.
- 6) Place hose over drain and release clamp.
- 7) Allow the tank to drain completely.

NOTE: It may be necessary to pinch the hose and stop the water before container is full. Carefully reinstall hose over fill valve outlet, then empty container. Repeat steps 4-7 completely to drain tank.

Remove Brew Valve

- 1) Disconnect power to machine.
- 2) Remove top cover and remove wires and small tube from valve.
- 3) Tilt inlet of valve down and pull sideways out of spray tee.
- 4) Clamp rubber tubing and disconnect valve from tubing.

Remove Heater

- 1) Disconnect power and remove top cover of brewer.
- 2) Disconnect wire leads to heater.
- 3) Remove tank cover by loosening retaining screw(s). Cover is lifted up with heater attached. Heater is then removed.
- 4) Replace heater with sealing washers in same configuration. When tightening nuts, hold element so it does not twist.
- 5) Replace tank cover ensuring gasket seal is good.
- 6) Replace heater wires. Be sure all electrical connections are secure.

Special Control Functions

User Lockout

User Lockout is achieved via the position of the LOCK jumper on the board header. Locate the header on the board (shown below) and place the jumper in the desired position. In the *Locked* position all menus in this document are locked out, and the unit will only allow brewing functions. There are two versions of the header, 10 pin and 2 pin. Both configurations are shown below.

10 Pin Version

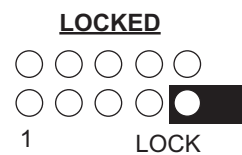
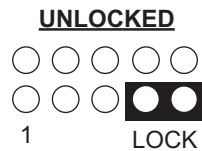

2 Pin Version

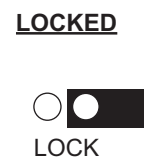
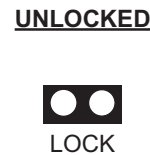

System Restore Function

This function will restore a Precision Brew® unit to its original factory settings. To activate system restore, power on the unit while holding in the *DOWN* button on the keypad (use the keypad that controls the *RIGHT* side for a double unit).

Continue holding the *DOWN* button and the display will scroll “*rEStorE*” to indicate that a system restore is about to happen. If the *DOWN* button is released at this point, the restore is cancelled. If the button hold is continued, the display will scroll “*donE*” to show completion of a system restore.

Upon a successful restore, the original factory settings will override all changes. The brew counters are not affected.

Factory Specific Features

The following sections describe features that are not intended to be used by the end user. These features, instead, are intended to help Grindmaster set up and test the machine.

Factory/Field Test Menu

This menu is intended to check product functionality both at the end of the factory line and in the field. The control must be completely OFF (both sides) to enter field test. This mode is entered by pressing and holding the *UP* key and the *LARGE BREW* key on the keypad (use the keypad that controls the *RIGHT* side for a double unit) for 6 seconds. Once the menu is entered, the unit will start with an LED test that lights all LEDs and segments on the display.

Proceeding through the field test is done by pressing the ON/OFF key (RIGHT side if a double unit). Each time this button is pressed, the test will advance to the next step. For the output test, use the *UP* and *DOWN* keys to select the desired output.

Refer to the table on the following page for operation. Field Test Mode exits after stepping through all modes only- there is not a timeout.

Factory/Field Test Menu (cont.)

Step	Function	Operation	Description
1	LED Test	All LEDs ON	Verify that all LEDs turn on.
2	Firmware Version	Display firmware version	Shows the software version of the control.
3	Date Code	Not used	Not used
4	EEPROM Version	Not used	Not used
5	Non Resetable Unit Counter	Scroll non-resetable unit counter	Shows the total number of brews made by the brewer (both sides if a double unit)
6	Display Water Temperature	Show averaged A/D reading of temperature	Shows the current temperature in °F of the thermister.
7	Display Water Level 1	Show averaged A/D reading of water level 1	If > 500 water level is full, If < 500 water level is not full.
8	Display Water Level 2	Show averaged A/D reading of water level 2	If > 500 water is at the heater level, If < 500 water level not at the heater level.
9	Show Input	Display scrolls "InPut"	Input Test Mode
10	Input Test	Press each key and the display will show a number related to that key	Right Side On/Off - 1 (advances test) Up - 5 Down - 3 Large Brew - 4 Medium Brew - 2 Small Brew - 0 Basket Switch - 17 Left Side On/Off - 9 Up - 13 Down - 11 Large Brew - 12 Medium Brew - 10 Small Brew - 8 Basket Switch - 16
11	Show Output	Display scrolls "outPut"	Output Test Mode
12	Output Test	Turns on each relay separately. Displays "O##" where: ## = 2 digit output number IMPORTANT: Each output will be turned ON when its number is on the display REGARDLESS of temperature or fill level. Be CAREFUL not to overflow the tank and keep electric items out of the way of the brew channel.	Scroll through relay outputs with the UP and DOWN keys. Outputs are as follows: O01 - Fill Valve O02 - Right Bypass Valve O03 - Left Bypass Valve O04 - Right Brew Valve O05 - Left Brew Valve O06 - <i>not used</i> O07 - Tank Heater O08 - Right Basket Lock O09 - Left Basket Lock O10 - <i>not used</i>

Troubleshooting

The following pages are provided to help determine the cause of problems with operation of the brewers and to indicate the appropriate solution for the problems. For each problem, the possible causes should be checked in the order shown until the exact nature of the problem is determined.

The following procedures must be performed by a qualified service technician. Disconnect power to machine before servicing.

Error Messages			
Problem	Possible Causes	Service Check	Remedy
ER1	<ul style="list-style-type: none"> • Fill valve on for over 6 min. (This occurs during initial fill on some units – see Initial Start-up.) 	<ul style="list-style-type: none"> • Check system for water leaks. 	<ul style="list-style-type: none"> • Correct any leaks and reset controller.
ER2	<ul style="list-style-type: none"> • Thermistor failure or loose connections in thermistor circuit. 	<ul style="list-style-type: none"> • Ensure that connector is securely attached to controller and that thermistor is securely connected. 	<ul style="list-style-type: none"> • Secure connections and reset controller. If error reoccurs, replace thermistor.
ER3	<ul style="list-style-type: none"> • Thermistor is reading out of range. 	<ul style="list-style-type: none"> • Check tank temperature. 	<ul style="list-style-type: none"> • Replace thermistor.
ER4	<ul style="list-style-type: none"> • No heat is detected 	<ul style="list-style-type: none"> • See Heating Problems 	<ul style="list-style-type: none"> • See Heating Problems

Filling Problems			
Problem	Possible Causes	Service Check	Remedy
Overfilling water tank when power is Off	<ul style="list-style-type: none"> • Fill valve not sealing properly. 	<ul style="list-style-type: none"> • Check to see if water enters tank continuously (usually at a slow rate). 	<ul style="list-style-type: none"> • Disassemble valve and clean out debris. Valve may need to be replaced.
Overfilling water tank only when power is On	<ul style="list-style-type: none"> • High electrode coated with lime or faulty. • Connection from control board to tank body faulty. • Control board is faulty. 	<ul style="list-style-type: none"> • Disconnect electrode wire at quick connect (brown wire). Connect a wire from the quick connect to the cabinet body. If filling stops, this is the error cause. • Check to ensure connection (red wire) is secure. • Secure connection from control board to metal enclosure does not stop filling. 	<ul style="list-style-type: none"> • Remove electrode assembly and clean the probes. If problem is not corrected, replace electrode assembly. • Make connection to tank secure. • Replace control board.

Troubleshooting (cont.)

Filling Problems			
Problem	Possible Causes	Service Check	Remedy
Tank does not refill	<ul style="list-style-type: none"> • No electrical power to equipment • No water supplied to equipment • No power to control board • No power to control board and transformer not powered. • No power to control board and transformer powered. 	<ul style="list-style-type: none"> • Check for proper voltage at terminal block. Check circuit breaker on supply circuit. • Disconnect water supply line and ensure that water is provided to unit. Check to see that any and all valves in water line are open. • Check for proper voltage across transformer primary terminals by disconnecting terminals. See wiring diagram for more information. • Ensure there is proper voltage across terminal block. Check wiring diagram for more information. • Disconnect quick disconnect on secondary side of transformer at quick disconnect between yellow and blue wires. Check for 24 Vac between blue and yellow wires. 	<ul style="list-style-type: none"> • Establish electrical power to unit. • Establish water supply to unit. • If there is not 120V across primary, proceed to step entitled “No power to control board and transformer not powered.” If there is proper voltage across primary, proceed to step entitled “No power to control board and transformer powered”. • Secure connections and reset circuit breaker on equipment. • If there is not 24 Vac between the blue and yellow wires, replace transformer. If proper voltage exists, secure connection between 3 pin connector and control board.

Troubleshooting (cont.)

Filling Problems			
Problem	Possible Causes	Service Check	Remedy
Tank does not refill	<ul style="list-style-type: none"> • Fill valve or control board is faulty 	<ul style="list-style-type: none"> • Check to ensure proper connection between 6 pin connector and control board. Check for proper connections at fill valve terminals. Drain 1 gal. (3.8L) of water from hot water faucet. Check for 24 Vac across fill valve terminals. 	<ul style="list-style-type: none"> • If 6 pin connector is securely attached to control board and all connections are secure and there is 24 Vac across fill valve terminals, replace fill valve.

Heating Problems			
Problem	Possible Causes	Service Check	Remedy
Tank does not heat	<ul style="list-style-type: none"> • No electrical power to equipment • No power to control board 	<ul style="list-style-type: none"> • Check for proper voltage at terminal block. Check circuit breaker on supply circuit. • Check for proper voltage across transformer primary terminals by disconnecting terminals. See wiring diagram for more information. 	<ul style="list-style-type: none"> • Establish electrical power to unit. • If there is not proper voltage across primary, proceed to step entitled “No power to control board and transformer not powered”. If there is proper voltage across primary, proceed to step entitled “No power to control board and transformer powered”.

Troubleshooting (cont.)

Heating Problems			
Problem	Possible Causes	Service Check	Remedy
<p>Tank does not heat</p>	<ul style="list-style-type: none"> • Low (long) electrode coated with lime or faulty. • Connection from control board to tank body faulty. • Connections from control board to heater relay faulty. • Line voltage connections to heater relay faulty. • Connections to remainder of heater circuit faulty. • Heater relay faulty. • Thermal cut-out tripped or faulty. 	<ul style="list-style-type: none"> • Disconnect electrode wire at quick connect (purple wire). Connect a wire from the quick connect to the cabinet body. If heating begins, this is the error cause. • Check to ensure connection (green wire) is secure. • Check to ensure connections (gray and blue wires) are secure. • Check to ensure connections (black and brown wires) are secure. • Check to ensure connections from relay to thermal cut-out and from thermal cut-out to contactor and from contactor to proper terminal of terminal block are secure. See wiring diagram for more information. • Ensure that coil on heater relay is energized by ensuring that there is 24 VDC between the gray and blue wires attached to the relay. Remove the black and brown wires from the relay and check for an open circuit across the connection tabs (COM and NO) to which the wires were attached. • Check for open circuit on thermal cut-out. (NOTE: Tripping of thermal cut-out can indicate presence of another problem with the unit. Unit should be monitored) 	<ul style="list-style-type: none"> • Remove electrode assembly and clean the probes. If problem is not corrected, replace electrode assembly. • Make connection to tank secure. • Make connections to relay secure. • Make connections to relay secure. • Make connections secure. • If the relay coil is energized and there is an open circuit across the connection tabs, replace relay. • Replace thermal cut-out.

Troubleshooting (cont.)

Heating Problems			
Problem	Possible Causes	Service Check	Remedy
Tank does not heat	<ul style="list-style-type: none"> • Contactor faulty. • Heater faulty. • Control board is faulty. 	<ul style="list-style-type: none"> • Ensure that coil on contactor is energized by ensuring that there is proper voltage between the brown and white wires attached to the relay. Check each side of the contactor (Line and Load) at each pole for continuity. • Check resistance across element(s) with power conductors disconnected. • Check to ensure proper connection between connector 5-pin and control board. Check for proper connections in all heater control circuitry. Check for proper connections between N terminal of contactor coil and terminal block. 	<ul style="list-style-type: none"> • If the contactor coil is energized and there is an open circuit across any of the contactor poles, replace contactor. • If resistance is much less than 8 Ohms or much more than 15 Ohms, replace heater(s). • If 5-pin connector is securely attached to control board and all connections are secure and functioning except there is not 120 Vac across contactor coil terminals, replace control board.

Brewing Problems			
Problem	Possible Causes	Service Check	Remedy
Brew volume too large or too small	<ul style="list-style-type: none"> • Portion selected on touchpad not correct. • Timer not set properly. 	<ul style="list-style-type: none"> • Review timer settings versus portion size. • Compare timer setting to either factory setting or initial user setting to determine if it has been changed. 	<ul style="list-style-type: none"> • Adjust timer to desired value or select different portion size. • Adjust timer to desired value.

Troubleshooting (cont.)

Brewing Problems			
Problem	Possible Causes	Service Check	Remedy
Brew volume too large or too small	<ul style="list-style-type: none"> • Sprayhead clogged. • Brew valves clogged with lime deposits. • Water supply pressure or flow rate not adequate. 	<ul style="list-style-type: none"> • Visually check for clogging of holes in brewhead. • Visually inspect brew valve at hose connections. • Check to see that fill valve cycles on and off frequently during brew cycle when all brew heads are used simultaneously. Check to ensure that water supply line is 3/8" and pressure is between 30 and 80 psi (207 and 552 KPA). 	<ul style="list-style-type: none"> • Clean all holes. • Clean lime from valve. Seat, cup or entire valve may need replacement. • Supply water at adequate pressure and flow rate.
Brew volume erratic	<ul style="list-style-type: none"> • Water supply pressure fluctuates. 	<ul style="list-style-type: none"> • Check water pressure with and without other appliances operating. 	<ul style="list-style-type: none"> • Plumb water supply so that water pressure is not significantly affected by other appliances.
Note: Small variations from batch to batch are normal.			
Brew cycle will not start	<ul style="list-style-type: none"> • Optional momentary switch to indicate container in place not engaged or faulty. • Brew circuit connections not secure. • Brew valve faulty. • Touchpad faulty. 	<ul style="list-style-type: none"> • Check to see that container fully engages switch. Check for continuity across switch when switch is engaged. • Check to see that connector (6-pin) is securely connected to control board. Check to see that all connections from controller through brew valve are secure. • Check to see if there is 24 Vac across brew valve terminals. • Check to see that touchpad connections to control board are secure. 	<ul style="list-style-type: none"> • If fully engaged switch does not complete circuit across terminals of switch, replace switch. • Secure connections. • If there is 24 Vac across terminals and brew valve is not open, replace valve. • If connections are secure, other functions appear normal and touchpad will not initiate a brew cycle, replace touchpad.

Troubleshooting (cont.)

Brewing Problems			
Problem	Possible Causes	Service Check	Remedy
Brew cycle will not start	<ul style="list-style-type: none"> • Controller faulty. 	<ul style="list-style-type: none"> • Check to see that the power is supplied to the controller by following instructions given in the Troubleshooting section on Filling Problems. Once touchpad and momentary switch integrity is assured (see above), initiate a brew cycle and check for 24 Vac across brew valve. 	<ul style="list-style-type: none"> • If there is not 24 Vac across brew valve, replace control board.
Sprayhead will not stop dripping water	<ul style="list-style-type: none"> • Brew valve not closing completely. • Water in tank boiling. 	<ul style="list-style-type: none"> • Visually inspect brew valve at hose connections. • Remove sprayhead and determine if drip is coming from overflow. 	<ul style="list-style-type: none"> • Clean lime from valve. Seat, cup or entire valve may need replacement. • Reduce tank temperature.

If you still need help, call our Service Department at (800) 695-4500 (USA and Canada only) or (502) 425-4776 (Monday-Friday 8:00 am - 6:00 pm EST) or an authorized service center in your area. Please have the model and serial number ready so that accurate information can be given.

Prior authorization must be obtained from Grindmaster-Cecilware's Technical Services Department for all warranty claims.

A530-066 Control Board

used on all PrecisionBrew™ V2.0 models

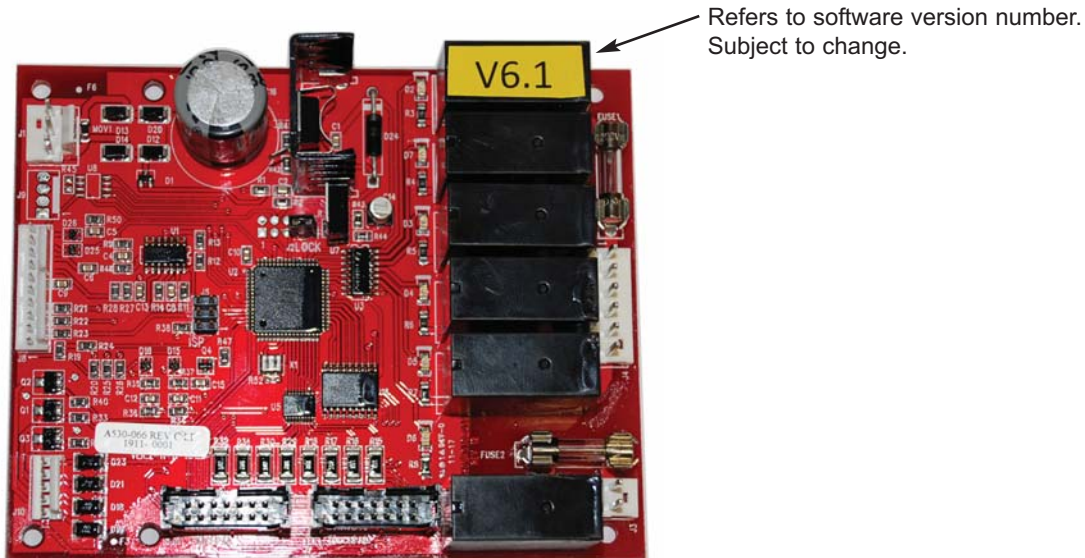

Parts List for All Precision Brew Models

Models APB-330V2, APB-430V2, APBVSA-330V2, APBVSA-430V2, APBIC-330V2, APBIC-430V2

ITEM	DESCRIPTION	PART #
Reference Front View Picture:		
1	Controller PB	A530-066
2	Relay, Heater*	A71450
3	Water Inlet Valve 24 VAC	A725-117
4	Terminal Block	A531-035
5	Spray Head	APT400-105
6	Orifice Bypass	A518-053
6A	Retaining Pin for A518-053	A551-098
8	Switch Momentary ** PBIC only	A531-025
Reference Lower Warmer Picture:		
20	Faucet Hot Water	A537-043
21	Light Warmer	A515016
22	Switch Warmer	A531-026
23	Heater Warmer 120V 100W	A535-018
23	Heater Warmer 220V 100W	A535-079 (for E230 models)
Reference Top View Picture:		
30	Thermostat, Hi Limit	A536-023
31	Contactator 4-Pole (120VAC coil)**	A514005 (for models with 3 heaters)
31	Contactator 2-Pole (120VAC coil)**	A515027
31	Contactator for 2-Pole E230V models	A531-083 (230VAC coil)
31	Contactator for 4-Pole E230V models	A531-076 (230VAC coil)
32	Transformer, 120/208/240 100W	A554-137
33	Valve, Brew 24VAC PB	A537-184V
34	Valve, Bypass 24VAC PB	A537-183V
35	Solenoid, Basket Lock 24vdc	A554-135
36	Touchpad PB Series	A530-065
37	N/A	N/A
38	Spray Elbow	A518-054
39	Tee Barbed 3/8" KYNAR	A548-172
40	Hose Overflow	A585-016
41	Hose Silicone	A512012
42	Elbow Silicone	A548-129
Reference Tank Lid Picture:		
50	Element Ht 5kW 240V (PB, PBVS)	A535-010 (for models with 3 heaters)
50	Element Ht 5kW 240V (PBIC)	A535-072 (for models with 3 heaters)
50	Element Htr 6.6kW 240V ** (PB, PBVSA)	A535-059
50	Element Htr 6.6kW 240V ** (PBIC)	A535-071
50	Element Htr 3.7kW 240V ** (PB, PBVSA)	A535-068 (for models with 3 heaters)
50	Element Htr 3.7kW 240V ** (PBIC)	A535-073 (for models with 3 heaters)
51	Thermistor	A536-027
52	Electrode Assembly	A712-018
53	Gasket Tank **	A544-029

* A531-072 = 12VDC coil; A71450 = 24VDC coil

** part not shown

Front View (refer to key on page 27)

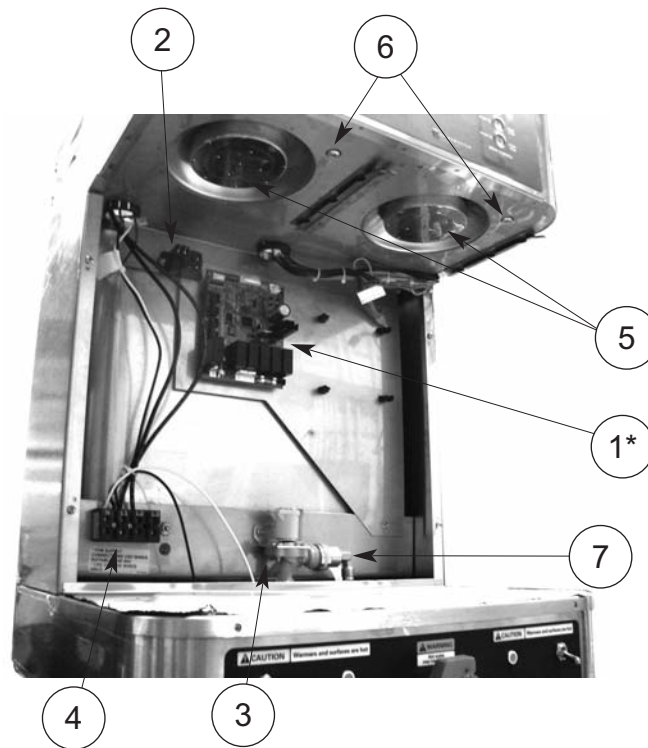

Lower Warmer (refer to key on page 27) (APB-430V2 pictured)



Top View (refer to key on page 27)

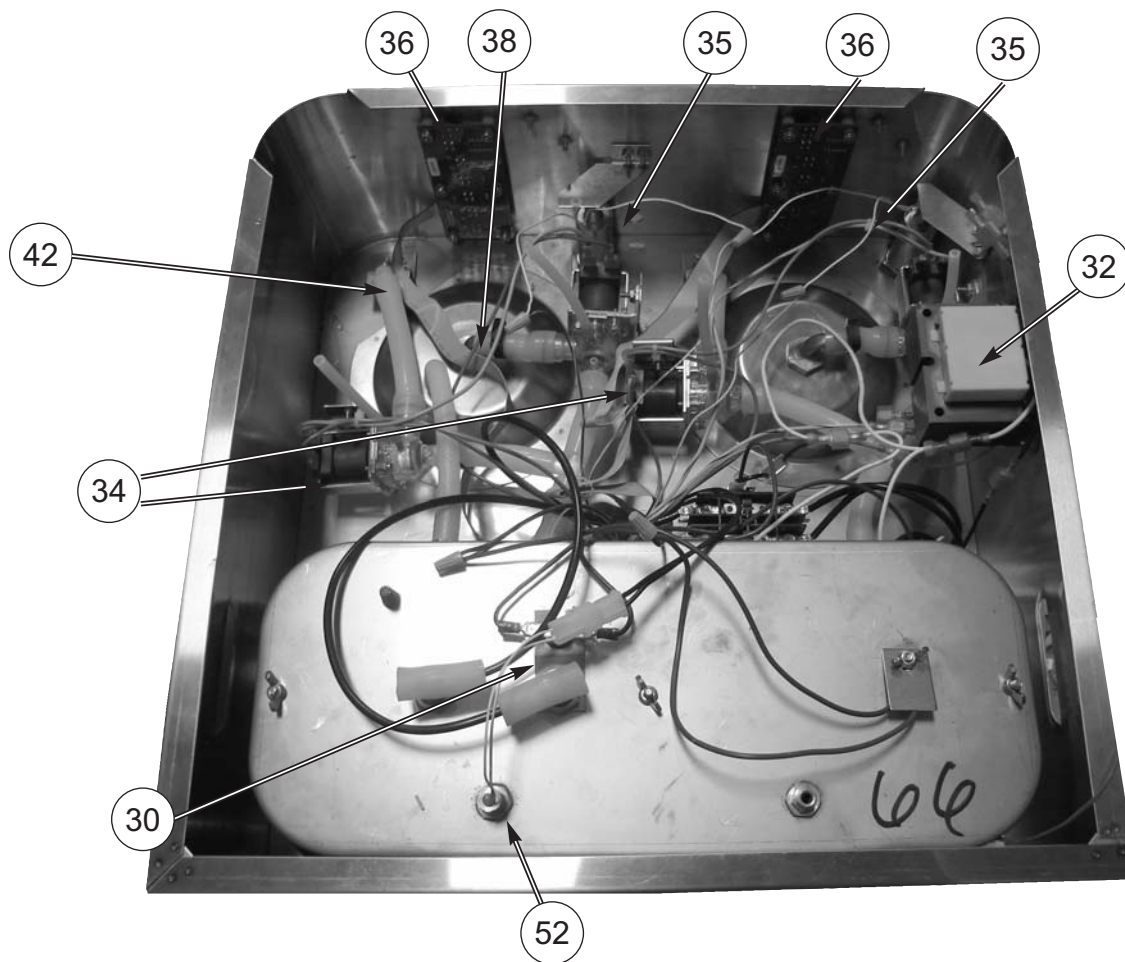

Tank Lid (refer to key on page 27)
3 Heater Model shown

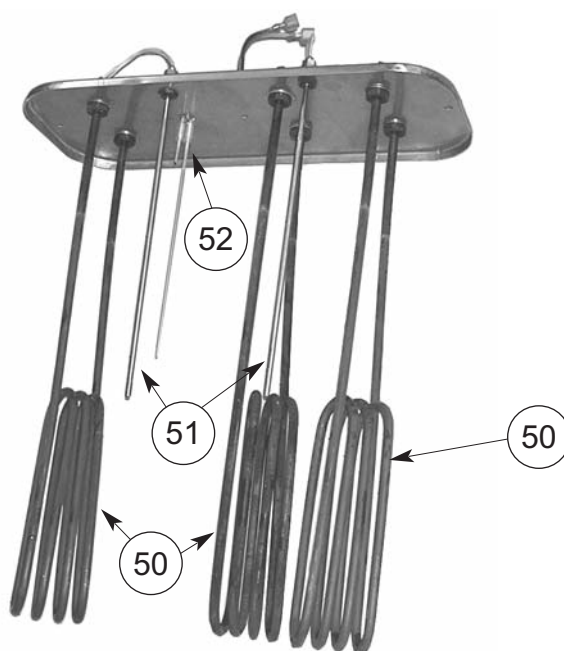

Shuttle Parts List

for APB-330V2 and APB-430V2

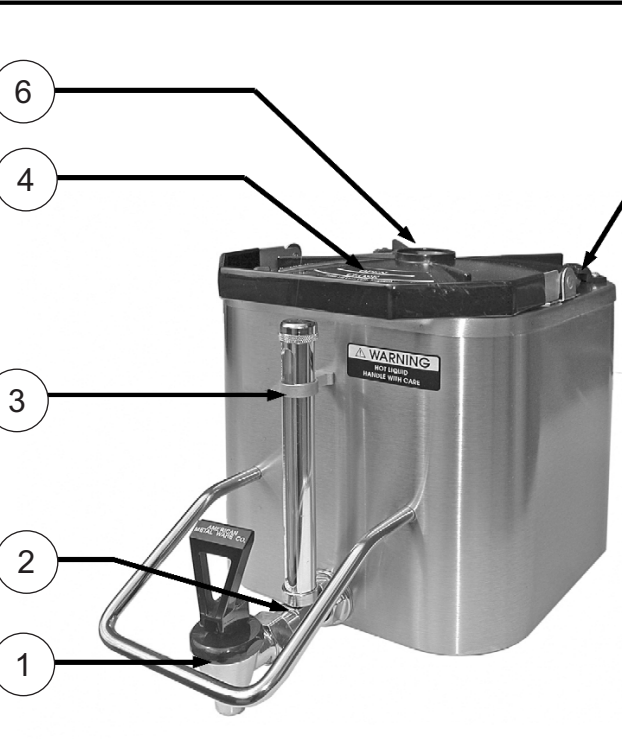

ITEM	DESCRIPTION	PART #
1	Faucet Model ES	A537-053
2	Shank w/ Chrome Bonnet	A522078
3	Gauge Assembly	A718-018
4	Kit, Shuttle Lid	A725-092
	S.S. Shuttle Cover (not shown)*	A713-027
5	Lid Retaining Clip	A548-142
6	Lid Stopper w/ O-Ring	A548-140 A61365

* S.S. Cover used until August 2001

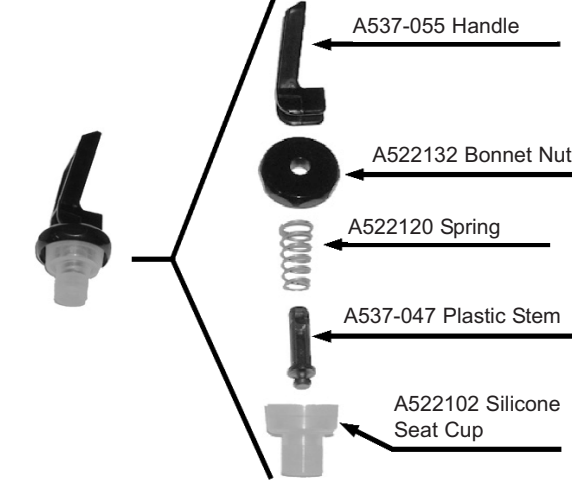

**Upper Faucet
(Part # A537-049)**

- A537-055 Handle
- A522132 Bonnet Nut
- A522120 Spring
- A537-047 Plastic Stem
- A522102 Silicone Seat Cup

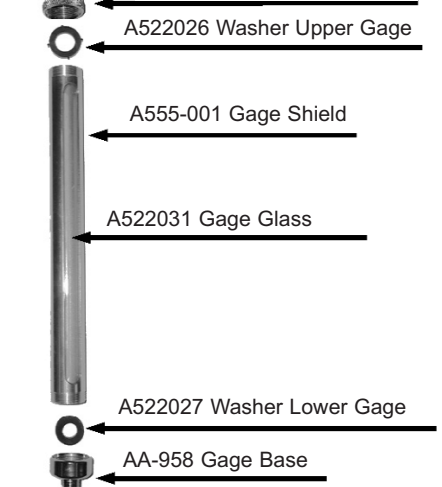

**Gauge Assembly
(Part # A718-018)**

- A318-119P Top Gage Fitting
- A522026 Washer Upper Gage
- A555-001 Gage Shield
- A522031 Gage Glass
- A522027 Washer Lower Gage
- AA-958 Gage Base

Model VS-1.5 Vacuum Shuttle Parts List

VS-S

ITEM NO.	Title	PART NUMBER	VS-S/QTY.
1	Stand Body	A548-157	1
2	Tray for Stand	A548-159	1
3	Stand Base	A548-158	1
4	Tray Top	A517-018	1
5	Stand, Top Plate	A517-019	1
6	NUT M4 W Nylon Insert	A540-237	4
7	Self-Tapping Screw .5"	A539-217	4
8	Rubber Foot	A548-161	4

VS-1.5S

ITEM NO.	Title	PART NUMBER	VS-1.5S/QTY.
1	Stand Body	A548-157	1
2	Tray for Stand	A548-159	1
3	Vacuum Shuttle	VS-1.5	1
4	Stand Base	A548-158	1
5	Tray Top	A517-018	1
6	Self-Tapping Screw .5"	A539-217	4
7	Rubber Foot	A548-161	4
8	Plastic Insert	A548-162	3
9	Self-Tapping Screws .75"	A539-218	3

Cleaning & Sanitizing Instructions

for Model VS-1.5(S)

These cleaning and sanitizing instructions are only a guideline to be used for the cleaning and sanitizing of the VS-1.5S and VS-S with VS-1.5. In-house cleaning and sanitizing methods may be more effective. Grindmaster assumes no responsibility for the food born illness and/or sickness caused by using improper sanitizing methods.

For cleaning and sanitizing of the VS-1.5S and VS-S with VS-1.5 the three-sink method is recommended. The three-sink method consists of the sink full of hot soapy water using an approved detergent, a fresh water rinse, and an aqueous sanitizing solution using an approved iodine sanitizer with mixture between 12.5-25 PPM.

1) Rinsing the unit after use:

- a) Rinse unit with hot water and empty completely.
- b) Fill unit with hot water.
- c) Open unit and empty contents completely by opening the faucet completely.

2) Cleaning and sanitizing lid assembly:

- a) Remove lid from unit, fully submerge it in cleaning solution. Using a clean cloth, wipe the unit thoroughly.
- b) Using supplied brush, clean mixing tube thoroughly.
- c) Rinse with clean water.
- d) Submerge in sanitizing solution for 5 minutes then air dry completely.

3) Cleaning and sanitizing body assembly:

- a) Remove unit from the base. (only when using VS-S with VS-1.5)
- b) Completely fill the unit with cleaning solution. Using a clean cloth, wipe the unit thoroughly.
- c) Rinse unit thoroughly with fresh water.
- d) Remove faucet, shank, and sight gauge from unit and place in cleaning solution.
- e) Open lid on the bottom of the unit and remove silicon tube (Tank to Faucet Tube) and place in cleaning solution for cleaning.
- f) Reassemble unit.
- g) Fully fill unit with sanitizing solution for 5 minutes and drain through fully opened faucet.
- h) Wipe outside of the unit with a clean cloth moistened with sanitizing solution.
- i) Place unit on rack upside down to thoroughly air-dry.

4) Cleaning Stand Assembly and tray:

- a) Remove tray and tray top and place in cleaning solution. Using a clean cloth, clean tray and tray top thoroughly.
- b) Wipe outside of the stand with a clean cloth moistened with sanitizing solution.
- c) Place parts on rack to thoroughly air-dry.

5) Cleaning the Faucet assembly and silicone tube:

- a) Using supplied brush, clean silicone tube, sight gauge tube, and shank assembly.
- b) Rinse parts and place in sanitizing solution for 5 minutes, remove and air dry.
- c) Remove top from faucet and use brush to clean inside, rinse and place in sanitizing solution for 5 minutes. Remove and air dry.

6) When all pieces are completely dry reassemble for use.

Wiring Diagram - Precision Brew 430 Series

Models APB-430V2, APBUSA-430V2, and APBIC-430V2

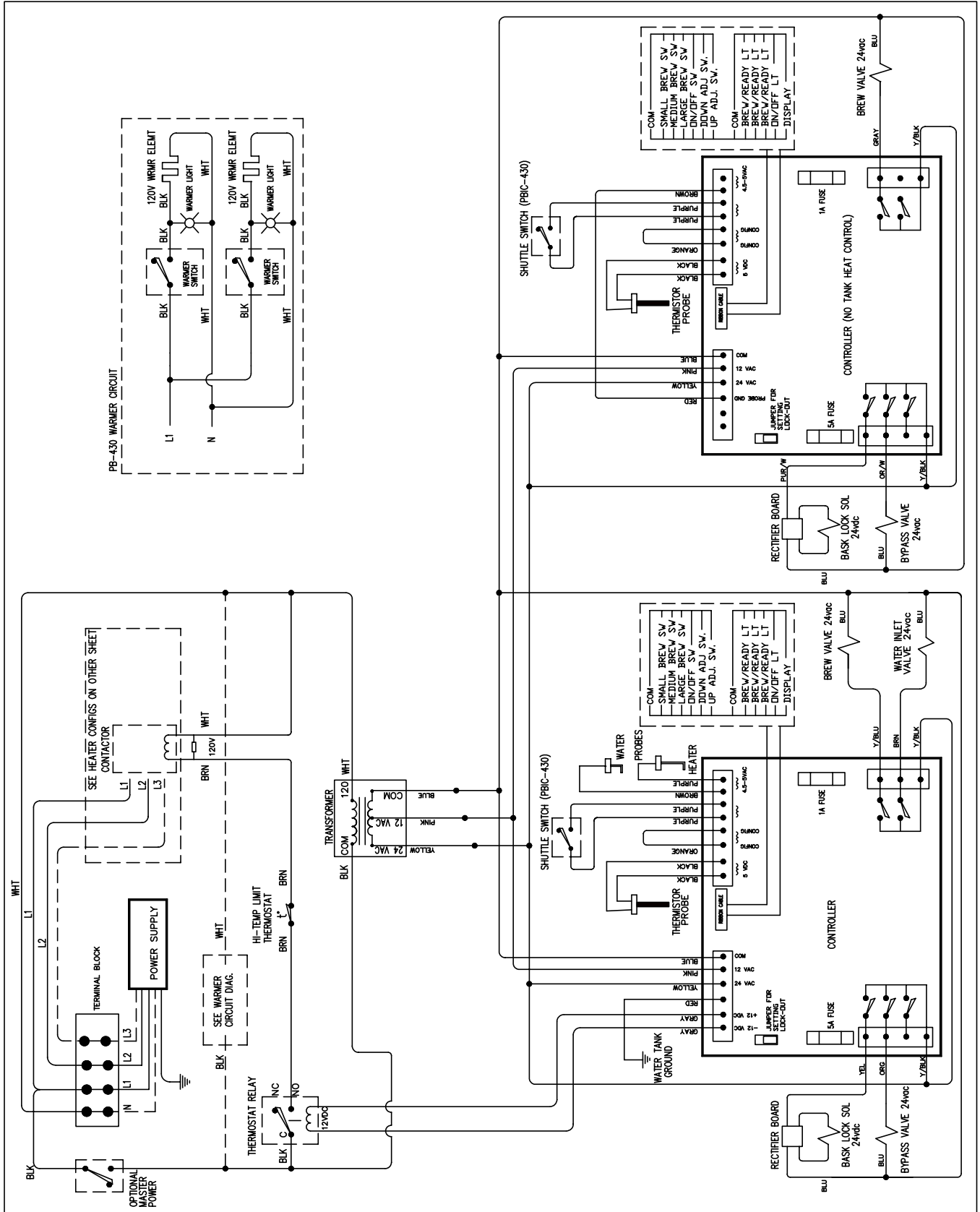

Wiring Diagram - Precision Brew 330 Series

Models APB-330V2, APBVSA-330V2, and APBIC-330V2

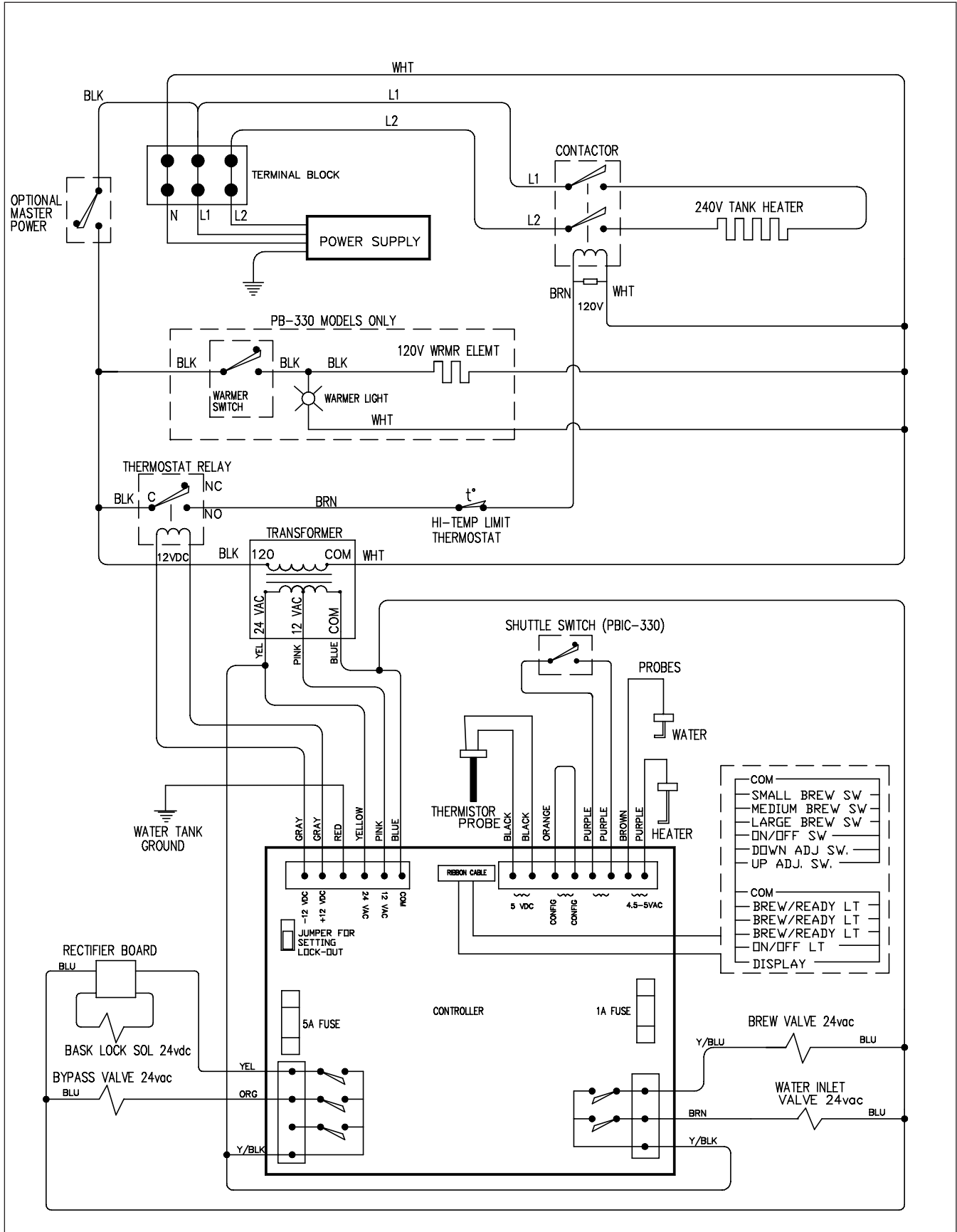

Wiring Diagram

APB-430V2E230, APBVSA-430V2E230, APBIC-430V2E230
(Single or Three Phase Models)

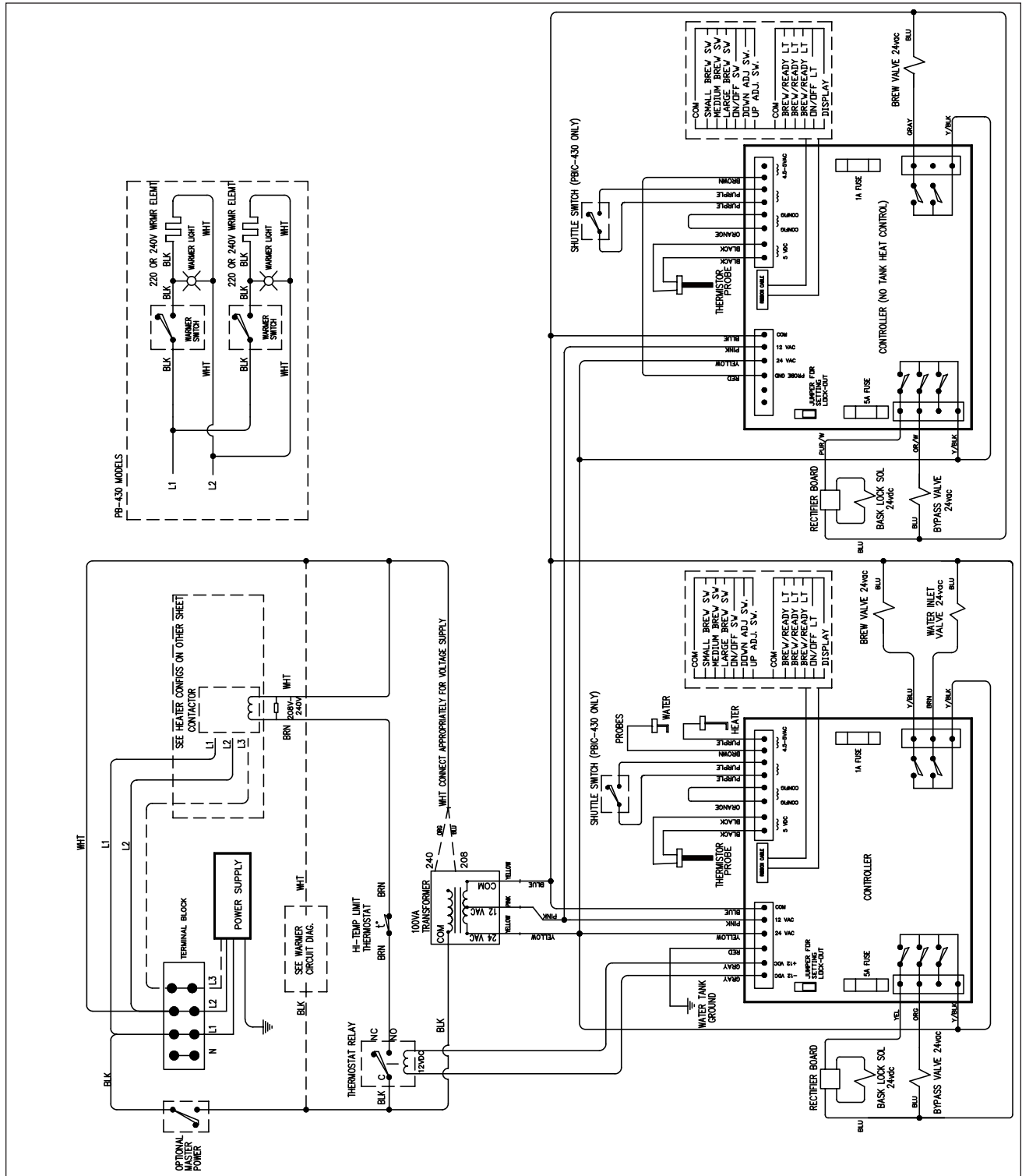

Wiring Diagram

APB-330V2E230, APBVSA-330V2E230, APBIC-330V2E230 Brewers

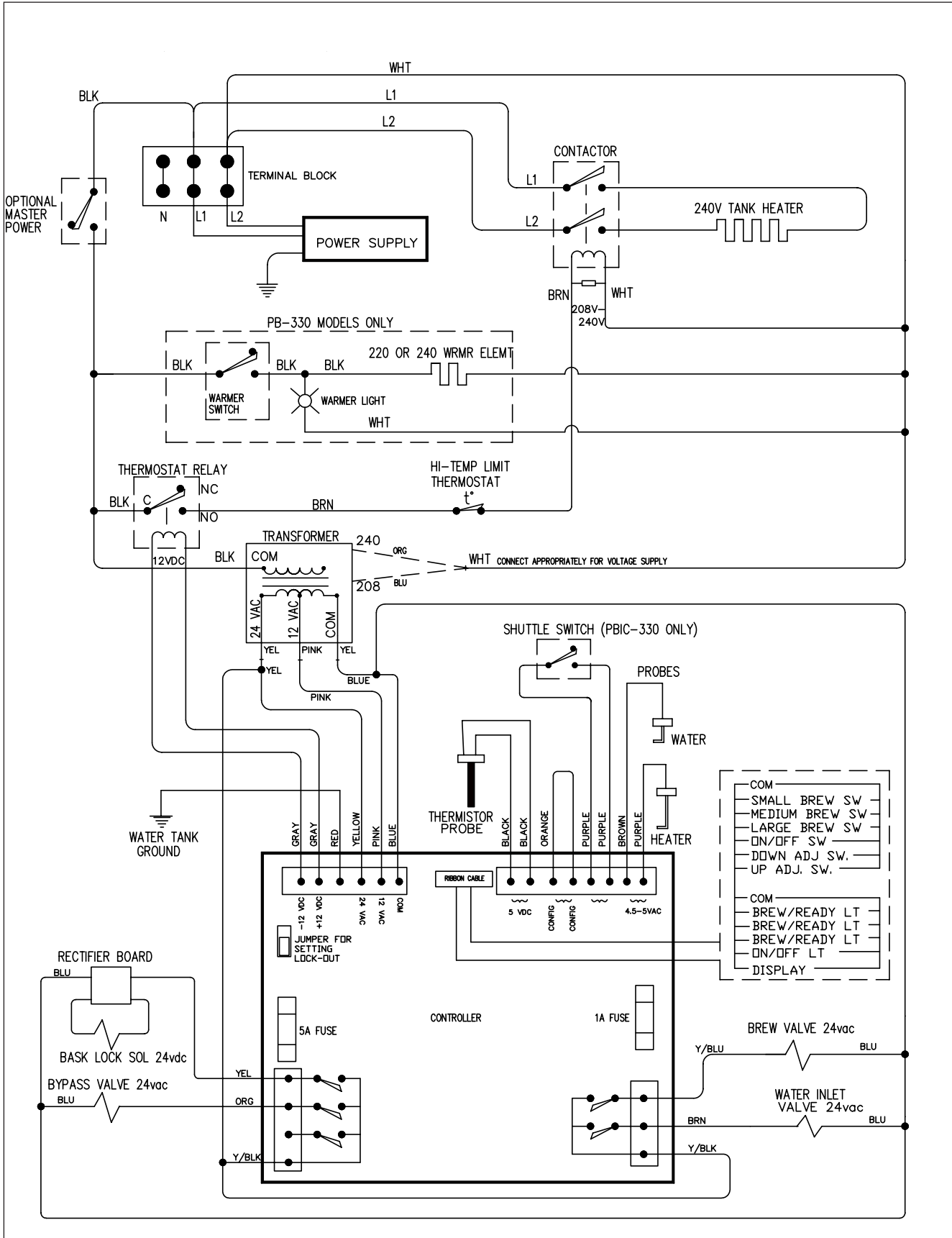

Wiring Diagram - Precision Brew 430 Series

120/208 or 120/240V
Models APB-430V2, APBVSA-430V2, and APBIC-430V2

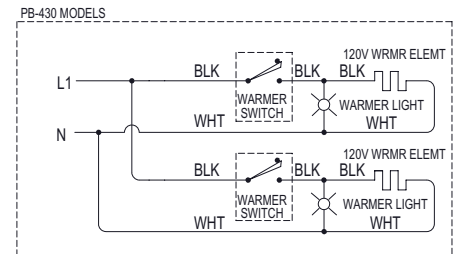
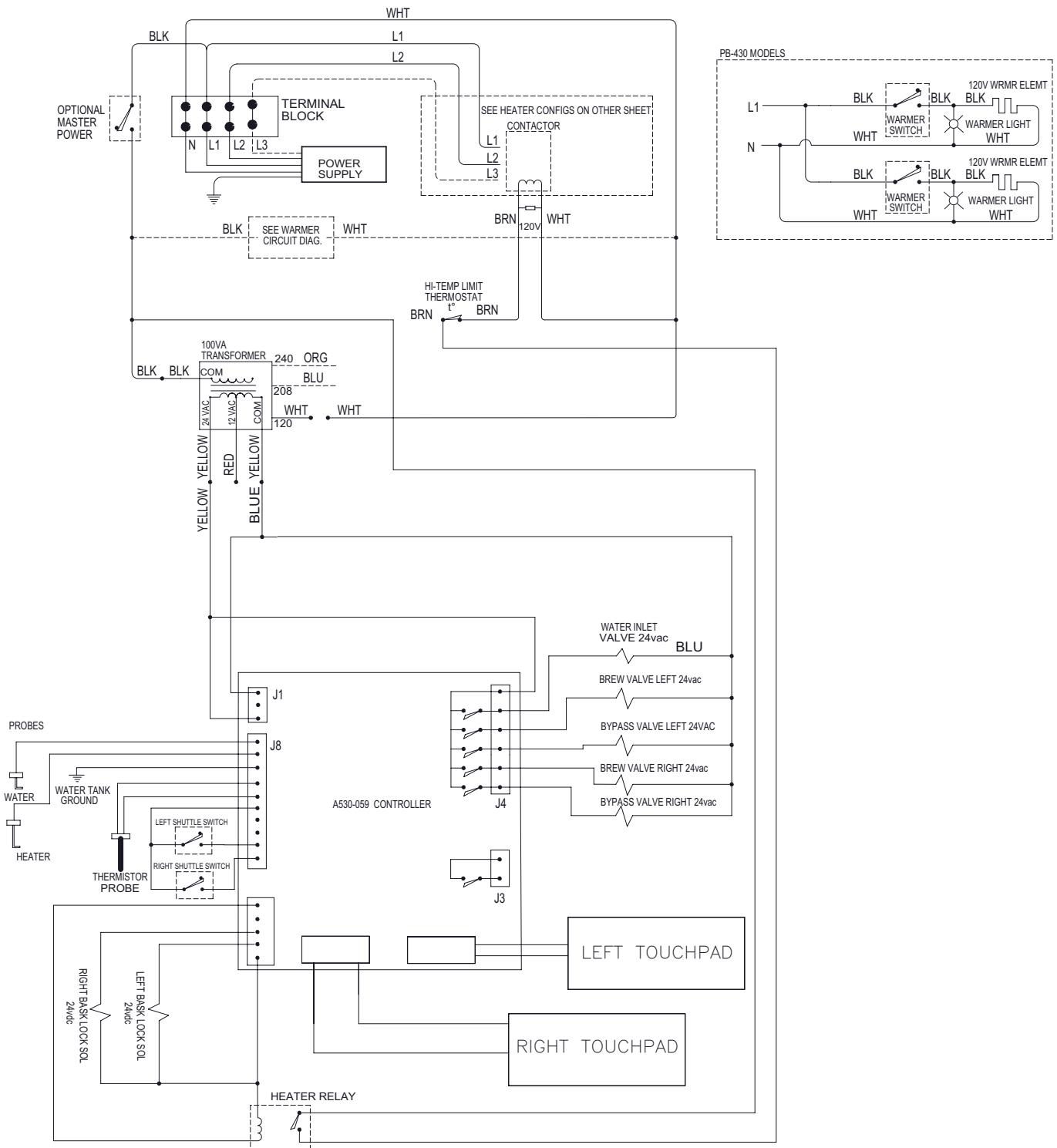

Wiring Diagram - Precision Brew 330 Series

120/208V, 120/240V

Models APB-330V2, APBVSA-330V2, and APBIC-330V2

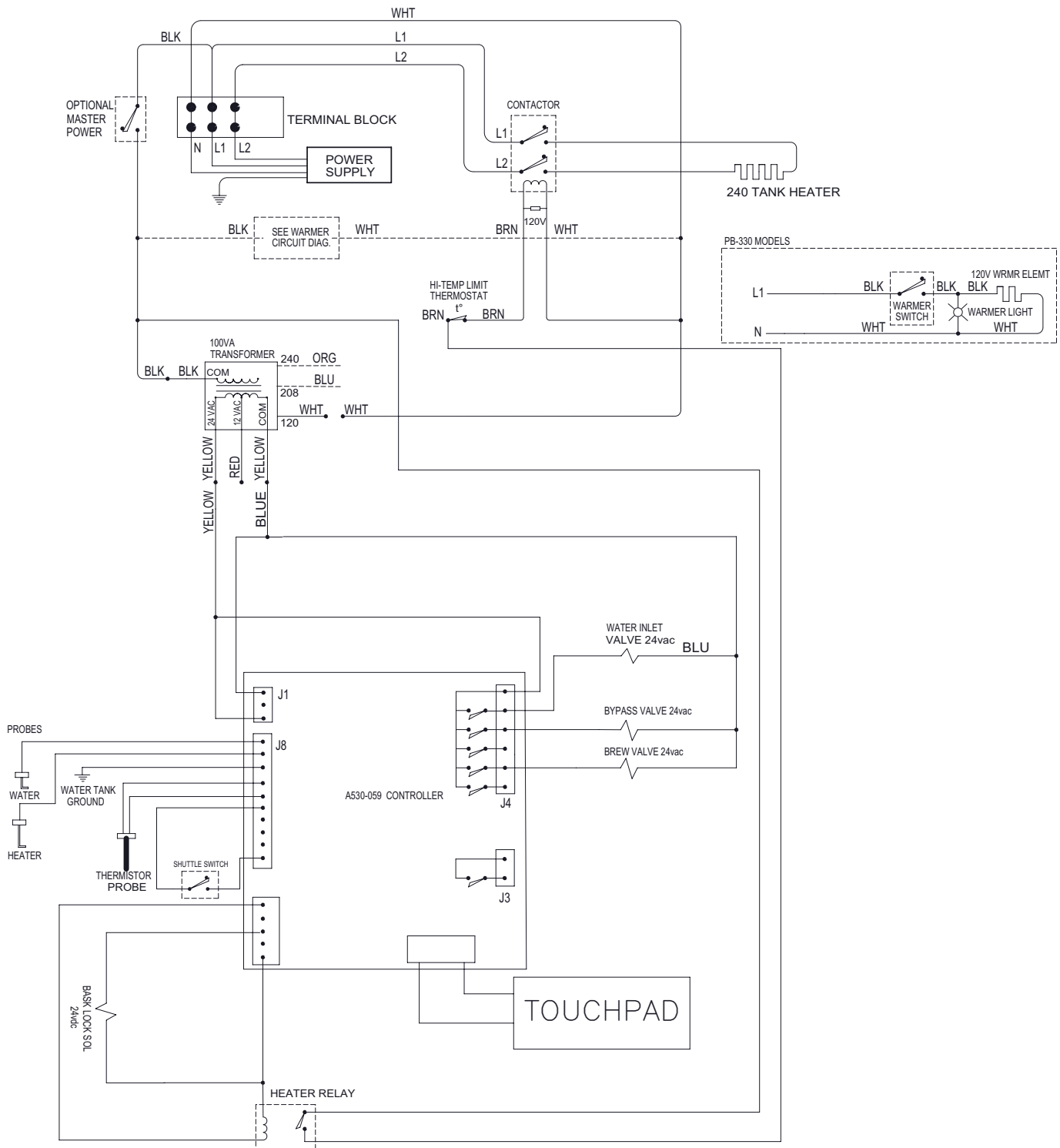

Wiring Diagram

230V, 208V, or 240V without Neutral

Models APB-430V2, APBVSA-430V2, APBIC-430V2, APB-430V2E230, APBVSA-430V2E230, and APBIC-430V2E230

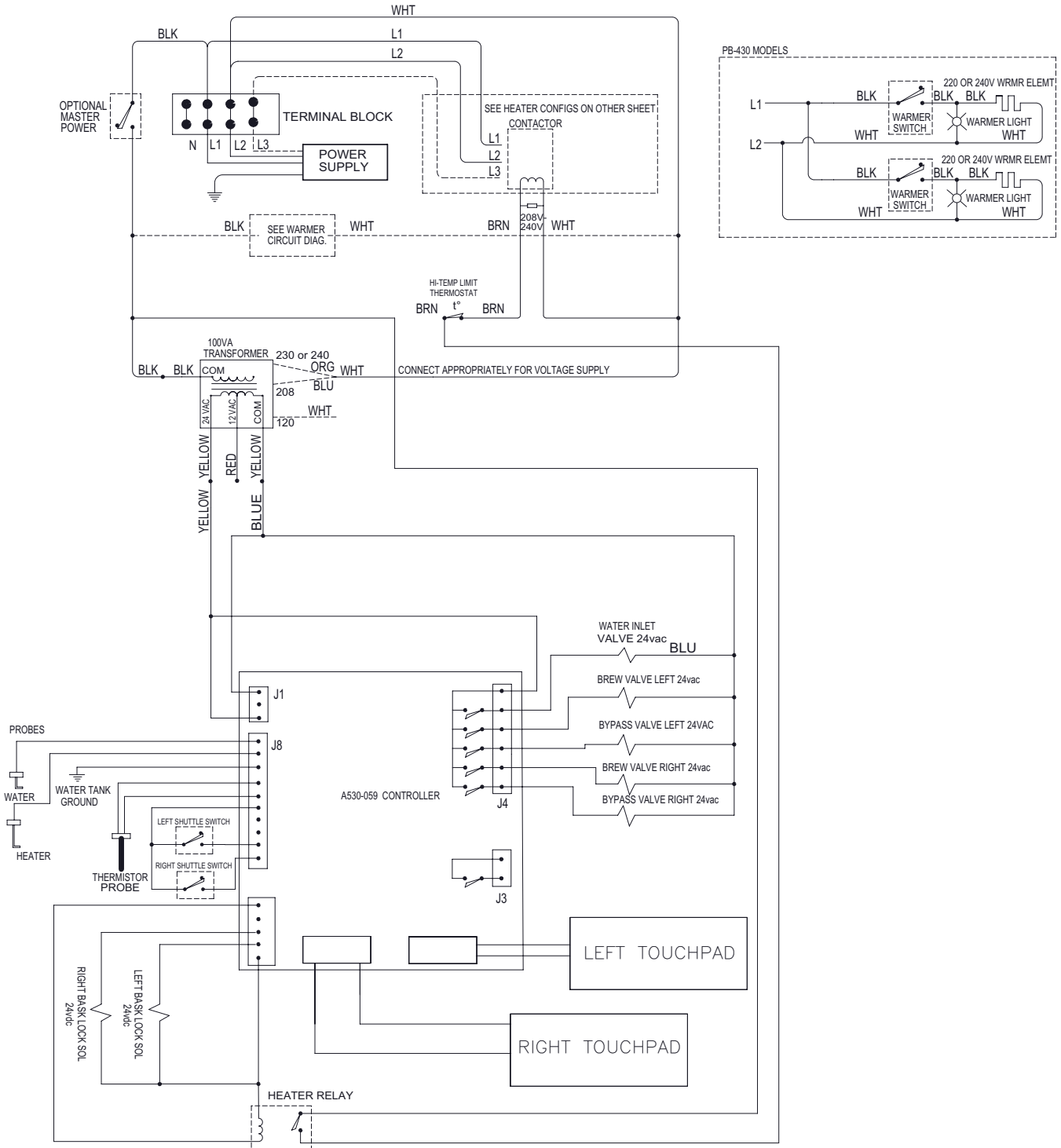

Wiring Diagram

230V, 208V, or 240V without Neutral

Models APB-330V2, APBVSA-330V2, APBIC-330V2, APB-330V2E230, APBVSA-330V2E230, APBIC-330V2E230

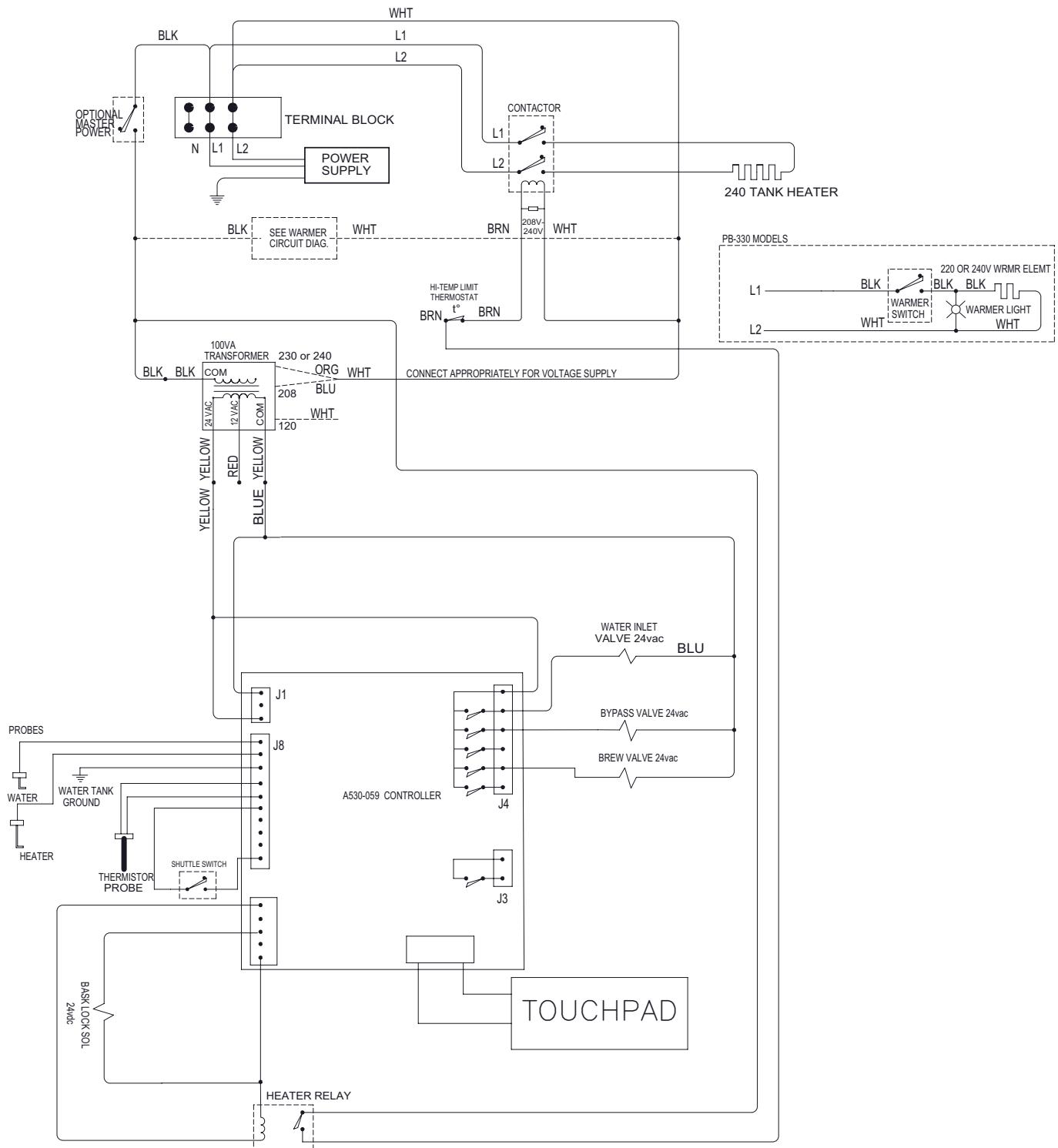

Wiring Diagram - Heater Configuration (3 Heater)

THREE HEATER OPTION CONFIGURATION HOOKUP DIAGRAM

NOTE: MACHINE IS EQUIPPED WITH (3) 5kW 240 VAC ELEMENTS WHICH CAN BE CONFIGURED TO ACHIEVE VARIOUS WATTAGE OUTPUTS PER THE CHART BELOW DEPENDING ON POWER SOURCE AVAILABLE

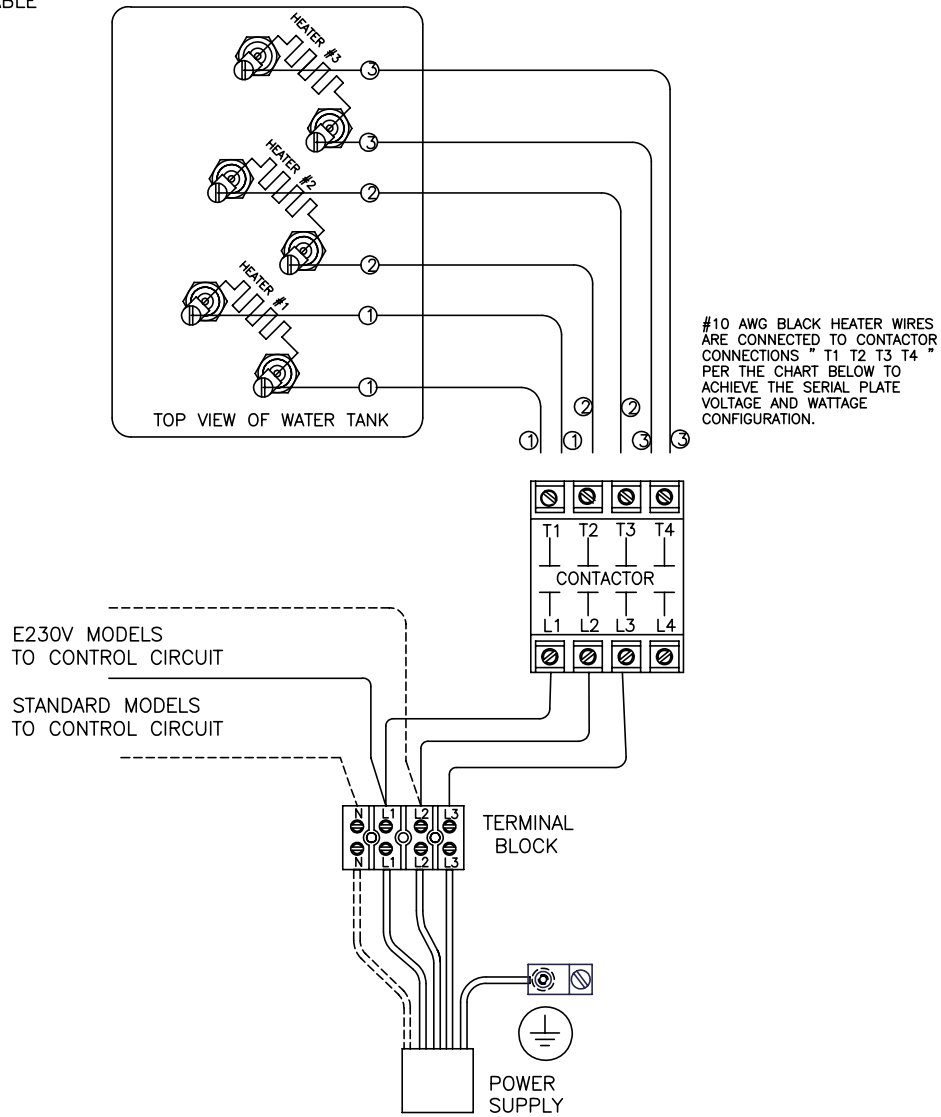

# OF ELEMENTS UTILIZED	VOLTAGE	WATTS	AMPS	CONNECT NUMBERED HEATER WIRES TO CONTACTOR TERMINALS PER CHART BELOW			
				T1	T2	T3	T4
SINGLE PHASE							
0.5	208	1878	9	1	2	1,2	3,3
1	208	3756	18	1	1	2,2	3,3
1.5	208	5633	27	1,2	1,3	2,3	-
2	208	7511	36	1,2	1,2	3,3	-
0.5	240	2500	10	1	2	1,2	3,3
1	240	5000	21	1	1	2,2	3,3
1.5	240	7500	31	1,2	1,3	2,3	-
2	240	10000	42	1,2	1,2	3,3	-
THREE PHASE (DELTA CONFIGURATION)							
3	208	11300	32	1,2	1,3	2,3	-
3	240	15000	36	1,2	1,3	2,3	-

Wiring Diagram - Heater Configuration (1 Heater)

- 1) 120V INPUT+1.8KW/120V ELEMENT=1.8KW OUTPUT
- 2) 120V INPUT+6.6KW/240V ELEMENT=1.65KW OUTPUT
- 3) 240V INPUT+6.6KW/240V ELEMENT=6.6KW OUTPUT
- 4) 208V INPUT+6.6KW/240V ELEMENT=5.0KW OUTPUT

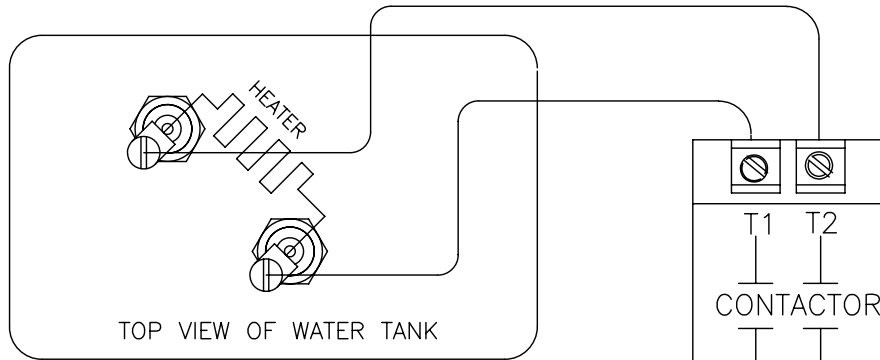

E230V MODELS
TO CONTROL CIRCUIT

STANDARD MODELS
TO CONTROL CIRCUIT

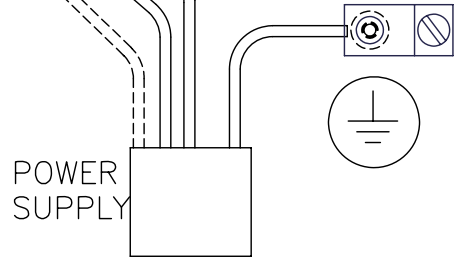
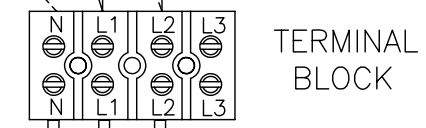

Control Board

all PrecisionBrew™ V2.0 models

Refers to software version number.
Subject to change.

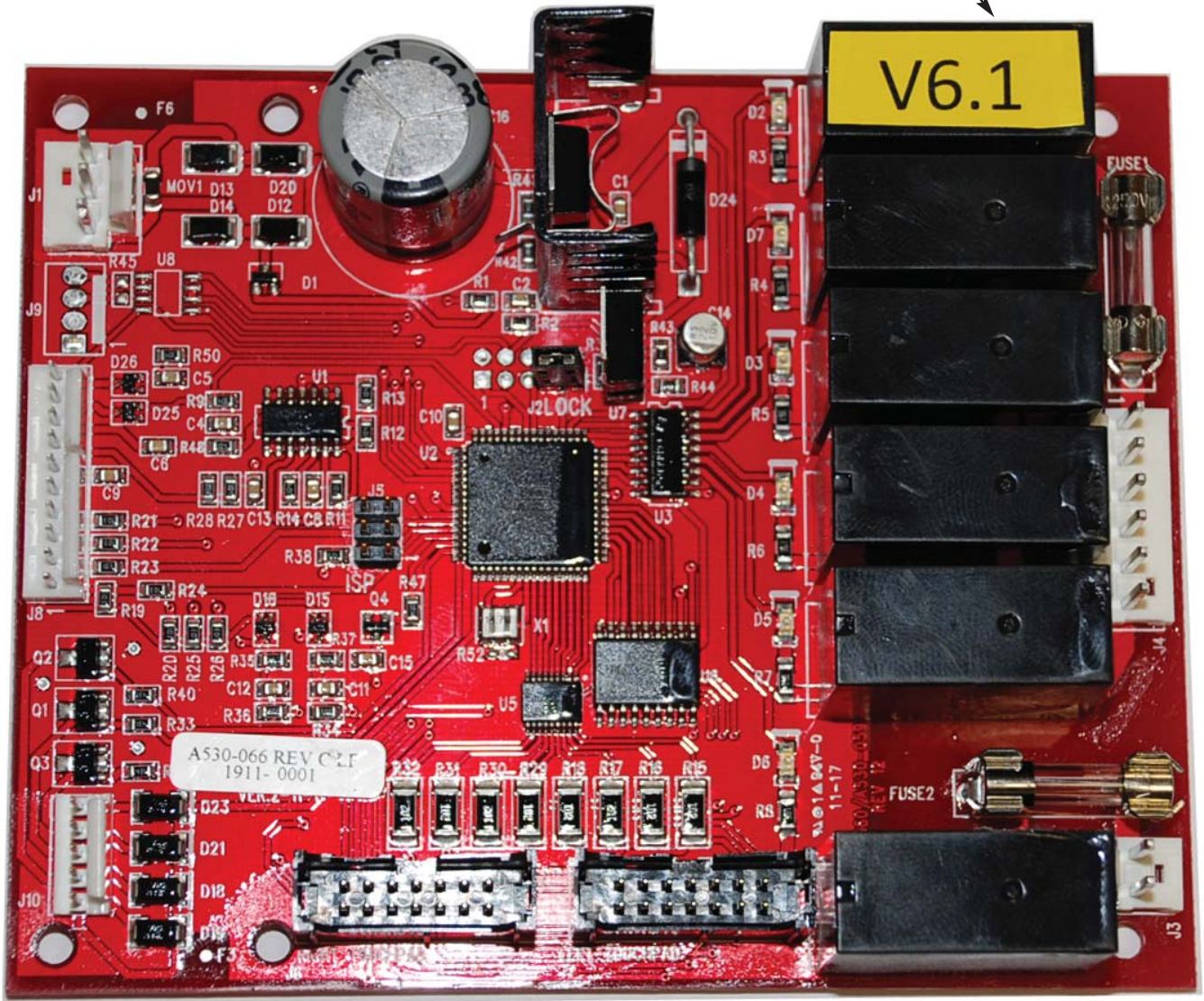



Tel (502) 425-4776 • Fax (502) 425-4664 • 1-800-695-4500 (USA & Canada only)
P.O. Box 35020 • Louisville, KY 40232 • USA