



RX-V357

AV Receiver

Ampli-tuner audio-vidéo

OWNER' S MANUAL
MODE D' EMPLOI
BEDIENUNGSANLEITUNG
BRUKSANVISNING
GEBRUIKSAANWIJZING
ИНСТРУКЦИЯ ПО ЭКСПЛУАТАЦИИ

CAUTION: READ THIS BEFORE OPERATING YOUR UNIT.

- 1 To assure the finest performance, please read this manual carefully. Keep it in a safe place for future reference.
- 2 Install this sound system in a well ventilated, cool, dry, clean place – away from direct sunlight, heat sources, vibration, dust, moisture, and/or cold. Allow ventilation space of at least 30 cm on the top, 20 cm on the left and right, and 20 cm on the back of this unit.
- 3 Locate this unit away from other electrical appliances, motors, or transformers to avoid humming sounds.
- 4 Do not expose this unit to sudden temperature changes from cold to hot, and do not locate this unit in a environment with high humidity (i.e. a room with a humidifier) to prevent condensation inside this unit, which may cause an electrical shock, fire, damage to this unit, and/or personal injury.
- 5 Avoid installing this unit where foreign object may fall onto this unit and/or this unit may be exposed to liquid dripping or splashing. On the top of this unit, do not place:
 - Other components, as they may cause damage and/or discoloration on the surface of this unit.
 - Burning objects (i.e. candles), as they may cause fire, damage to this unit, and/or personal injury.
 - Containers with liquid in them, as they may fall and liquid may cause electrical shock to the user and/or damage to this unit.
- 6 Do not cover this unit with a newspaper, tablecloth, curtain, etc. in order not to obstruct heat radiation. If the temperature inside this unit rises, it may cause fire, damage to this unit, and/or personal injury.
- 7 Do not plug in this unit to a wall outlet until all connections are complete.
- 8 Do not operate this unit upside-down. It may overheat, possibly causing damage.
- 9 Do not use force on switches, knobs and/or cords.
- 10 When disconnecting the power cord from the wall outlet, grasp the plug; do not pull the cord.
- 11 Do not clean this unit with chemical solvents; this might damage the finish. Use a clean, dry cloth.
- 12 Only voltage specified on this unit must be used. Using this unit with a higher voltage than specified is dangerous and may cause fire, damage to this unit, and/or personal injury. YAMAHA will not be held responsible for any damage resulting from use of this unit with a voltage other than specified.
- 13 To prevent damage by lightning, disconnect the power cord from the wall outlet during an electrical storm.
- 14 Do not attempt to modify or fix this unit. Contact qualified YAMAHA service personnel when any service is needed. The cabinet should never be opened for any reasons.
- 15 When not planning to use this unit for long periods of time (i.e. vacation), disconnect the AC power plug from the wall outlet.
- 16 Be sure to read the "TROUBLESHOOTING" section on common operating errors before concluding that this unit is faulty.
- 17 Before moving this unit, press **STANDBY/ON** to set this unit in standby mode, and disconnect the AC power plug from the wall outlet.

This unit is not disconnected from the AC power source as long as it is connected to the wall outlet, even if this unit itself is turned off. This state is called standby mode. In this state, this unit is designed to consume a very small quantity of power.

WARNING

TO REDUCE THE RISK OF FIRE OR ELECTRIC SHOCK, DO NOT EXPOSE THIS UNIT TO RAIN OR MOISTURE.

CONTENTS

INTRODUCTION

FEATURES	2
GETTING STARTED	3
Supplied accessories	3
Installing batteries in the remote control	3
CONTROLS AND FUNCTIONS	4
Front panel	4
Remote control	6
Front panel display	8

PREPARATION

CONNECTIONS	9
Before connecting components	9
Connecting video components	10
Connecting audio components	12
Connecting the antennas	13
Connecting an external decoder	14
Connecting the speakers	15
Connecting the power supply cord	18
Turning on the power	18
BASIC SYSTEM SETTINGS	19
Using the basic menu	19
Setting the unit to match your speaker system	21
SP LEVEL (Setting speaker output levels)	21

BASIC OPERATION

PLAYBACK	22
Input modes and indications	24
Selecting a sound field program	25
DIGITAL SOUND FIELD PROCESSING	28
(DSP)	28
Understanding sound fields	28
HiFi DSP programs	28
CINEMA DSP	29
Sound design of CINEMA DSP	29
CINEMA DSP Programs	29
Sound field effects	31
TUNING	32
Presetting stations	33
Selecting preset stations	35
RECEIVING RADIO DATA SYSTEM	36
Description of Radio Data System data	36
Changing the Radio Data System mode	36
PTY SEEK function	37
EON function	37
SLEEP TIMER	38
RECORDING	39

ADVANCED OPERATION

SET MENU	40
Set menu list	40
Adjusting the items on the set menu	40
SOUND 1 SPEAKER SET	41
(speaker mode settings)	41
SOUND 2 SP DISTANCE (speaker distance)	43
SOUND 3 LFE LEVEL	43
SOUND 4 D. RANGE (dynamic range)	43
SOUND 5 CENTER GEQ	44
(center graphic equalizer)	44
SOUND 6 HP TONE CTRL	44
(headphone tone control)	44
INPUT 1 I/O ASSIGN	44
(input/output assignment)	44
INPUT 2 INPUT MODE (initial input mode)	44
OPTION 1 DISPLAY SET	45
OPTION 2 MEM. GUARD (memory guard)	45
OPTION 3 AUDIO MUTE	45
ADVANCED SETUP MENU	46
SETTING THE SPEAKER LEVELS	47
Adjusting the speaker levels during playback	47
Using the test tone	47

ADDITIONAL INFORMATION

EDITING SOUND FIELD PARAMETERS	48
Changing parameter settings	48
Sound field parameter descriptions	49
TROUBLESHOOTING	50
RESETTING THE FACTORY PRESETS	53
GLOSSARY	54
SPECIFICATIONS	56

FEATURES

Built-in 5-channel power amplifier

- ◆ Minimum RMS output power (0.9% THD, 1 kHz, 6 Ω)
Front: 100 W + 100 W
Center: 100 W
Surround: 100 W + 100 W

Sound field features

- ◆ Dolby Pro Logic/Dolby Pro Logic II decoder
- ◆ Dolby Digital/Dolby Digital + Matrix 6.1 Decoder
- ◆ DTS/DTS + Matrix 6.1 Decoder
- ◆ CINEMA DSP: Combination of YAMAHA DSP technology and Dolby Pro Logic, Dolby Digital or DTS
- ◆ Virtual CINEMA DSP
- ◆ SILENT CINEMA™

Sophisticated AM/FM Tuner

- ◆ 40-Station random access preset tuning
- ◆ Automatic preset tuning
- ◆ Preset station shifting capability (Preset editing)

Other features

- ◆ 192 kHz/24-bit D/A converter
- ◆ Set menu for optimizing this unit for your Audio/Video system
- ◆ Test tone generator for easier speaker balance adjustment
- ◆ 6-channel external decoder input
- ◆ Optical and coaxial digital audio signal jacks
- ◆ Sleep timer

■ About this manual

- **y** indicates a tip for your operation.
- Some operations can be performed by using either the buttons on the main unit or on the remote control. In cases when the button names differ between the main unit and the remote control, the button name on the remote control is given in parentheses.
- This manual is printed prior to production. Design and specifications are subject to change in part for the reason of the improvement in operativity ability, and others. In this case, the product has priority.



Manufactured under license from Dolby Laboratories.

"Dolby", "Pro Logic", and the double-D symbol are trademarks of Dolby Laboratories.

SILENT™
CINEMA

"SILENT CINEMA" is a trademark of YAMAHA CORPORATION.



"DTS" and "DTS Digital Surround" are registered trademarks of Digital Theater Systems, Inc.

GETTING STARTED

Supplied accessories

Please check that you received all of the following parts.

Remote control



Batteries (2)
(AA, R06, UM-3)



Indoor FM antenna



AM loop antenna



Installing batteries in the remote control

Insert the batteries in the correct direction by aligning the + and - marks on the batteries with the polarity markings (+ and -) inside the battery compartment.

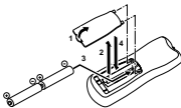

1 Press the tab of the battery compartment cover and pull it in the direction of the arrow to open the cover.

2 Remove the cover.

3 Insert the two batteries supplied (AA, R06, UM-3) according to the polarity markings on the inside of the battery compartment.

4 Put the cover back into place.

Notes on batteries

- Change all of the batteries if you notice a decrease in the operating range of the remote control.
- Do not use old batteries together with new ones.
- Do not use different types of batteries (such as alkaline and manganese batteries) together. Read the packaging carefully as these different types of batteries may have the same shape and color.
- If the batteries have leaked, dispose of them immediately. Avoid touching the leaked material or letting it come into contact with clothing, etc. Clean the battery compartment thoroughly before installing new batteries.
- Do not throw away batteries with general house waste; dispose of them correctly in accordance with your local regulations.

CONTROLS AND FUNCTIONS

Front panel

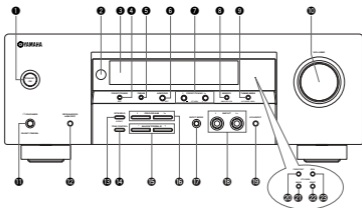

1 STANDBY/ON

Turns on this unit or sets it to the standby mode. When you turn on this unit, you will hear a click and there will be a 4 to 5-second delay before this unit can reproduce sound.

Note

• In standby mode, this unit consumes a small amount of power in order to receive infrared-signals from the remote control.

2 Remote control sensor

Receives signals from the remote control.

3 Front panel display

Shows information about the operational status of the unit.

4 PRESET/TUNING I

Switches the function of PRESET/TUNING I / h between selecting a preset station number and tuning (the colon (:) turns on or off).

(EDIT)

This button is also used to exchange the assignment of two preset stations with each other.

5 FM/AM

Switches the reception band between FM and AM.

6 A/B/C/D/E

Selects preset station groups A to E when the unit is in tuner mode.

(NEXT)

Selects the set menu mode when the unit is not in tuner mode.

7 PRESET/TUNING I / h

Select preset station numbers 1 to 8 when a colon (:) is displayed in the front panel display. Select the tuning frequency when a colon (:) is not displayed in tuner mode.

(SET MENU -/+)

Adjust settings on the set menu when the unit is not in tuner mode.

8 MEMORY (MAN'L/AUTO FM)

Stores a station in the memory.

9 TUNING MODE (AUTO/MAN'L MONO)

Switches the tuning mode between automatic and manual.

Ⓜ VOLUME

Controls the output level of all audio channels. This does not affect the OUT (REC) level.

Ⓝ PHONES (SILENT CINEMA)

Allows you to enjoy DSP effects when listening with headphones.

Ⓞ SPEAKERS A/B/OFF

Selects the set of front speakers connected to the A or B terminals. To turn off the speakers, press the button repeatedly and select OFF.

Ⓟ STEREO (EFFECT)

Switches between normal stereo and DSP effect reproduction. When you select STEREO, the unit mixes down all Dolby Digital and DTS signals (except the LFE channel) as well as those 2-channel signals without effect sounds to the front left and right speakers.

Ⓠ TONE CONTROL

Switches between Bass (low-frequency response) control mode and Treble (high-frequency response) control mode.

Ⓡ BASS/TREBLE \rightarrow / \leftarrow

Increase or decrease low/high-frequency response when the unit is in Bass/Treble control mode. The sound changes 2dB each time you press one of these buttons. Control range: -10 to +10 dB

Ⓢ PROGRAM I / h

Use to select sound field programs.

Ⓣ INPUT MODE

Sets the priority for the types of input signals (AUTO, DTS, ANALOG) received when one component is connected to two types of input jacks. You cannot set priority for an audio sources if you have selected 6CH INPUT as the input source.

Ⓤ INPUT I / h

Selects the input source you want to listen to or watch.

Ⓡ 6CH INPUT

Selects the audio source connected to the 6CH INPUT jacks. This selection takes priority over sources selected with INPUT (or the input selector buttons on the remote control).

Ⓢ FREQ/TEXT

Press this button when the unit is receiving an Radio Data System station, to cycle the display mode among PS mode, PTY mode, RT mode, CT mode (if the station offers those Radio Data System data service) and/or frequency display mode in turn.

Ⓣ PTY SEEK MODE

Press this button to set the unit in the PTY SEEK mode.

Ⓤ PTY SEEK START

Press this button to begin searching for a station after the desired program type has been selected in the PTY SEEK mode.

Ⓡ EON

Press this button to select a radio program type (NEWS, INFO, AFFAIRS, SPORT) to tune in automatically.

Remote control

This section describes the controls and functions of the remote control.

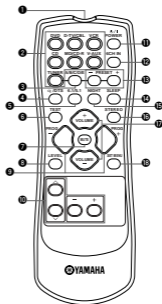

1 Infrared emitter

Outputs infrared control signals. Aim this emitter at the component you want to operate.

2 Input selector buttons

Select the input source.

3 A/B/C/D/E

Selects preset station groups A to E when the unit is in tuner mode.

4 DTS

Selects the built-in Dolby Digital, DTS, Dolby Pro Logic, or Pro Logic II decoder.

5 6.1/5.1

Switches on or off the Dolby Digital + Matrix 6.1 or DTS + Matrix 6.1 decoder.

6 TEST

Outputs the test tone to adjust the speaker levels.

7 MUTE

Mutes the sound. Press again to restore the audio output to the previous volume level.

8 LEVEL

Selects the effect speaker channel to adjust.

9 PROG +/-

Use to select sound filed programs.

10 Multi control section

Use to select and adjust sound field program parameters or SET MENU items.

11 POWER

Turns the unit on, or sets it in standby mode.

12 6CH IN

Selects the audio source connected to the 6CH IN jacks.

13 PRESET +/-

Select preset station numbers 1 to 8.

Ⓛ SLEEP

Sets the sleep timer.

Ⓜ NIGHT

Sets the unit in night listening mode.

Ⓝ STEREO

Switches between normal stereo and DSP effect reproduction. When you select STEREO the unit mixes down all Dolby Digital and DTS signals (except the LFE channel) as well as those 2-channel signals without effect sounds, to the front left and right speakers.

Ⓟ VOLUME +/-

Increases or decreases the volume level.

Ⓠ SET MENU

Selects the set menu mode.

■ Using the remote control

The remote control transmits a directional infrared beam. Be sure to aim the remote control directly at the remote control sensor on the main unit during operation.

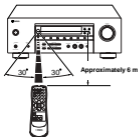
**■ Handling the remote control**

- Do not spill water or other liquids on the remote control.
- Do not drop the remote control.
- Do not leave or store the remote control in the following types of conditions:
 - high humidity such as near a bath
 - high temperature such as near a heater or stove
 - extremely low temperature
 - dusty places

Front panel display

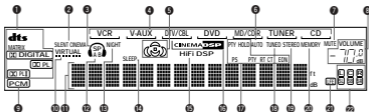
**1 Decoder indicators**

When any of this unit's decoders function, the respective indicator lights up.

2 SILENT CINEMA indicator

Lights up when headphones are connected and a sound field program is selected (see page 27).

3 Headphones indicator

Lights up when headphones are connected to the headphone jack.

4 Input source indicator

Highlights the current input source with a cursor.

5 Sound field indicator

Light to indicate the active DSP sound fields.

**6 AUTO indicator**

Shows that this unit is in the automatic tuning mode.

7 MUTE indicator

Flashes while the MUTE function is on.

8 VOLUME level indicator

Indicates the volume level.

9 PCM indicator

Lights up when this unit is reproducing PCM (pulse code modulation) digital audio signals.

10 VIRTUAL indicator

Lights up when using Virtual CINEMA DSP.

11 Multi-information display

Shows the current sound field program name and other information when adjusting or changing settings.

12 SP A B indicator

Lights up to indicate which set of front speakers is selected.

13 NIGHT indicator

Lights up when the unit is set to night listening mode.

14 SLEEP indicator

Lights up while the sleep timer is on.

15 HiFi DSP indicator

Lights up when you select a HiFi DSP sound field program.

16 CINEMA DSP indicator

Lights up when you select a CINEMA DSP sound field program.

17 Radio Data System indicators

The name(s) of the Radio Data System data offered by the currently received Radio Data System station light(s) up. EON lights up when an Radio Data System station that offers the EON data service is being received. PTY HOLD lights up while searching for stations in the PTY SEEK mode.

18 TUNED indicator

Lights up when this unit is tuned to a radio station.

19 STEREO indicator

Lights up when the unit is receiving a strong signal from an FM stereo broadcast while the "AUTO" indicator is lit.

20 MEMORY indicator

Flashes to show a station can be stored.

21 LFE indicator

Lights up when the input signal contains an LFE signal.

22 Input channel indicators

The indicators for the appropriate sound channels light up when a digital signal from a source is played back.

CONNECTIONS

Before connecting components

CAUTION

Do not connect this unit or other components to the mains power until all connections between the components have been completed.

- Be sure to connect the left channel (L), right channel (R), "+" (red) and "-" (black) properly. Some components require different connection methods and have different jack names. Refer to the operation instructions for each component you wish to connect to this unit.
- After you have completed all connections, check them again to make sure they are correct.
- The jack names correspond to the names on the input selector.

■ Connecting to digital jacks

This unit has digital jacks for direct transmission of digital signals through either a coaxial or fiber optic cable. You can use the digital jacks to input PCM, Dolby Digital and DTS bitstreams. Use digital connections if you wish to enjoy the multi-channel sound track of DVD material, etc. with DSP effects. Both digital input jacks are acceptable for 96 kHz sampling digital signals.

Note

- The OPTICAL jack on this unit conforms to the EIA standard. If you use a fiber optic cable that does not conform to EIA standard, this unit may not function properly.

Signal flow inside this unit

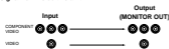

DIGITAL INPUT jacks (pages 9 – 12)

6CH INPUT jacks (page 14)

Video component jacks (page 10)

COMPONENT VIDEO jacks (page 11)

Speaker terminals (page 17)

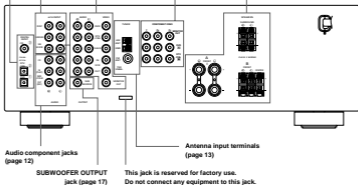

Connecting video components

■ Connecting a video monitor

Connect the video input jack on your video monitor to the MONITOR OUT VIDEO jack.

■ Connecting a DVD player/digital TV/cable TV

Connect the optical digital audio signal output jack on your component to the DIGITAL INPUT jack and connect the video signal output jack on the component to the VIDEO jack on this unit.

Use the AUDIO jacks on this unit for a video component which does not have optical digital output jack. However, multi-channel reproduction cannot be obtained with audio signals input from the AUDIO jacks. If you wish to enjoy the surround sound, use **C** / **DTS** on the remote control (see page 26).

You can also connect a video monitor, DVD player, digital TV, and cable TV to this unit using the COMPONENT VIDEO connections (see page 11).

■ Connecting another video component

Connect the video signal output jack on your component to the VIDEO jack on this unit.

Connect the audio signal output jacks on the component to the AUDIO jacks on this unit.

■ Connecting a recording component

Connect the audio signal input jacks on your video component to the AUDIO OUT jacks on this unit. Then connect the video signal input jack on the video component to the VIDEO OUT jack on this unit for picture recording.

Connect the audio signal output jacks on your component to the AUDIO IN jacks on this unit. Then connect the video signal output jack on the component to the VIDEO IN jack on this unit to play a source from your recording component.

Notes

- Once you have connected a recording component to this unit, keep its power turned on while using this unit. If the power is off, this unit may distort the sound from other components.
- If you connect your video monitor to this unit using a VIDEO connection, connect your video source components such as a DVD player or digital TV to this unit using the VIDEO connections.

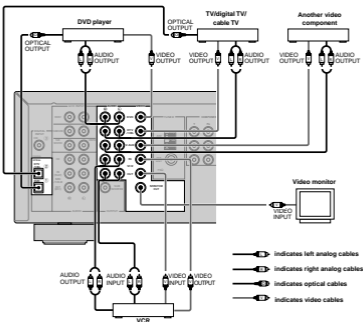

■ COMPONENT VIDEO jacks

You can enjoy high-quality pictures by connecting your video monitor and video source components to this unit using COMPONENT VIDEO connections.

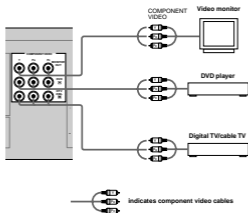

Note

- If you connect your video monitor to this unit using a COMPONENT VIDEO connection, connect your video source components such as a DVD player or digital TV to this unit using COMPONENT VIDEO connections.

Connecting audio components

■ Connecting a CD player

Connect the coaxial digital output jack on your CD player to the DIGITAL INPUT CD jack on this unit.

Use the AUDIO jacks on this unit to connect to a CD player that does not have a COAXIAL DIGITAL OUTPUT jack, or to record from CD players.

■ Connecting a CD recorder or MD recorder

Connect the input jacks on your CD recorder or MD recorder to the MD/CD-R OUT (REC) jacks.

Connect the output jacks on your CD recorder or MD recorder to the MD/CD-R IN (PLAY) jacks to play a source from your recording component.

Note

- Once you have connected a recording component to this unit, keep its power turned on while using this unit. If the power is off, this unit may distort the sound from other components.

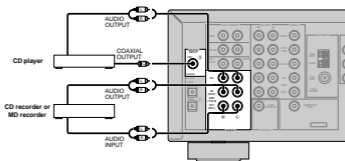

-  indicates left analog cables
-  indicates right analog cables
-  indicates coaxial cables

Connecting the antennas

Both AM and FM indoor antennas are included with this unit. In general, these antennas should provide sufficient signal strength.

Connect each antenna correctly to the designated terminals.

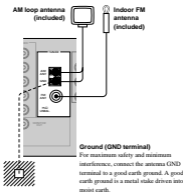

■ Connecting the AM loop antenna

- 1 Set up the AM loop antenna.

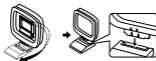

- 2 Press and hold the tab to insert the AM loop antenna lead wires into the AM ANT and GND terminals.



- 3 Orient the AM loop antenna for the best reception.



Notes

- The AM loop antenna should be placed away from this unit.
- The AM loop antenna should always be connected, even if an outdoor AM antenna is connected to this unit.
- A properly installed outdoor antenna provides clearer reception than an indoor one. If you experience poor reception quality, an outdoor antenna may improve the quality. Consult the nearest authorized YAMAHA dealer or service center about the outdoor antennas.

Connecting an external decoder

This unit is equipped with 6 additional input jacks (FRONT left and right, CENTER, SURROUND left and right and SUBWOOFER) for discrete multi-channel input from a component equipped with a multi-channel decoder and 6 channel output jacks such as a DVD/Super Audio CD player.

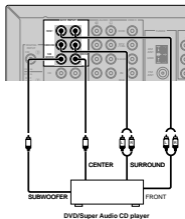

Notes

- When you select 6CH INPUT as the input source, this unit automatically turns off the digital sound field processor, and you cannot select sound field programs.
- When headphones are used, only front L/R channels are output.

Connecting the speakers

■ Speaker placement

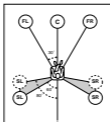

The speaker layout above shows the standard ITU-R speaker setting. You can use it to enjoy CINEMA DSP, multi-channel audio sources.

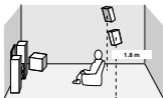

Front speakers (FR and FL)

The front speakers are used for the main source sound plus effect sounds. Place these speakers an equal distance from the ideal listening position. The distance of each speaker from each side of the video monitor should be the same.

Center speaker (C)

The center speaker is for the center channel sounds (dialog, vocals, etc.). If for some reason it is not practical to use a center speaker, you can do without it. Best results, however, are obtained with the full system. Align the front face of the center speaker with the front face of your video monitor. Place the speaker centrally between the front speakers and as close to the monitor as possible, such as directly over or under it.

Surround speakers (SR and SL)

The surround speakers are used for effect and surround sounds. Place these speakers behind your listening position, facing slightly inwards, about 1.8 m above the floor.

Subwoofer (SWFR)

The use of a subwoofer, such as the YAMAHA Active Servo Processing Subwoofer System, is effective not only for reinforcing bass frequencies from any or all channels, but also for high fidelity reproduction of the LFE (low-frequency effect) channel included in Dolby Digital and DTS software. The position of the subwoofer is not so critical, because low bass sounds are not highly directional. But it is better to place the subwoofer near the front speakers. Turn it slightly toward the center of the room to reduce wall reflections.

CONNECTIONS

■ Speaker connections

Be sure to connect the left channel (L), right channel (R), “+” (red) and “-” (black) properly. If the connections are faulty, no sound will be heard from the speakers, and if the polarity of the speaker connections is incorrect, the sound will be unnatural and lack bass.

CAUTION

- Use speakers with the specified impedance shown on the rear panel of this unit.
- Before connecting the speakers, make sure that the power of this unit is off.
- Do not let the bare speaker wires touch each other or do not let them touch any metal part of this unit. This could damage this unit and/or speakers.
- Use magnetically shielded speakers. If this type of speakers still creates the interference with the monitor, place the speakers away from the monitor.

Connecting to the FRONT A SPEAKERS terminals

A speaker cord is actually a pair of insulated cables running side by side. One cable is colored or shaped differently, perhaps with a stripe, groove or ridges. Connect the striped (grooved, etc.) cable to the “+” (red) terminals on this unit and your speaker. Connect the plain cable to the “-” (black) terminals.

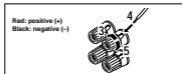
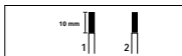

1 Remove approximately 10 mm of insulation from the end of each of the speaker cables.

2 Twist the exposed wires of the cable together to prevent short circuits.

3 Loosen the head of the screw.

4 Insert one bare wire into the hole in the side of each terminal.

5 Tighten the head of the screw to secure the wire.

Connecting to the FRONT B, CENTER and SURROUND SPEAKERS terminals

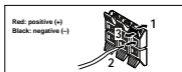

1 Press and open the tab.

2 Insert one bare wire into the hole of each terminal.

3 Release the tab to secure the wire.

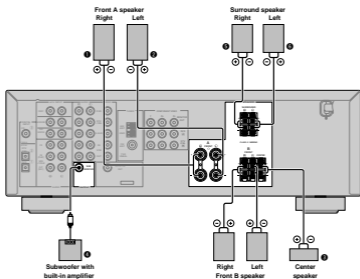

FRONT SPEAKERS terminals

You can connect up to two speaker systems to these terminals. When using only one speaker system, connect it to either of the FRONT A or the FRONT B terminals.

SURROUND SPEAKERS terminals

A surround speaker system can be connected to these terminals.

CENTER SPEAKER terminals

A center speaker can be connected to these terminals.

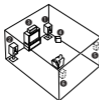

The diagram shows the speaker layout in the listening room.

SUBWOOFER jack

When using a subwoofer with built-in amplifier, including the YAMAHA Active Servo Processing Subwoofer System, connect the input jack of the subwoofer system to this jack. This unit will direct low bass signals distributed from the front, center and/or surround channels to this jack in accordance with your SPEAKER SET selections. The LFE (low-frequency effect) signals generated when Dolby Digital or DTS is decoded are also directed to this jack in accordance with your SPEAKER SET selections.

Notes

- The cut-off frequency of the SUBWOOFER jack is 90 Hz.
- If you do not use a subwoofer, allocate the signals to the front left and right speakers by changing the setting of "SOUND 1 SPEAKER SET" item "LD BASS" on the set menu to FRONT.
- Use the control on the subwoofer to adjust its volume level. You can also adjust the volume level by using this unit's remote control (see "SETTING THE SPEAKER LEVELS" on page 47).

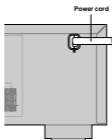
Connecting the power supply cord

- **Connecting the AC power cord**
Plug the power cord into an AC wall outlet.

Turning on the power

When all connections are complete, turn on the power of this unit.

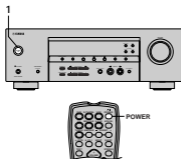

- 1 Press **STANDBY/ON** (or **POWER** on the remote control) to turn on the power of this unit.



Front panel



Remote control

The level of the volume, and then the current sound field program name appear on the front panel display.

BASIC SYSTEM SETTINGS

The "BASIC" menu allows you to set some of the basic "SOUND" menu parameters with a minimum of effort. If you wish to configure the unit more precisely to suit your listening environment, use the more detailed parameters from the "SOUND" menu instead of those under the "BASIC" menu (see page 41 to 44). Altering any parameters in the "BASIC" menu will reset all parameters in the "SOUND" menu.

Using the basic menu

Use the remote control to make adjustments.

- Press SPEAKERS A/B/OFF on the front panel to select the front speakers you want to use.
- Make sure you disconnect headphones from this unit.



1 Press SET MENU.

"BASIC MENU" appears on the front panel display.



If the front panel display changes to show anything other than "BASIC MENU", press SET MENU until it displays "BASIC MENU".

2 Press -/+ to enter into the BASIC menu.

"1 SETUP" appears on the front panel display.



3 Press ^/∨ to change the display to the setting you want to alter.

1 SETUP

Changes the speaker and amplifier settings to suit the size of the room you are using. Refer to "Setting the unit to match your speaker system" on page 21 for more information.

2 SP LEVEL

Adjusts the output levels of the speakers. Refer to "SP LEVEL" on page 21 for more information.

4 Press -/+ to enter the desired setting mode.

5 Change the unit settings to suit your listening environment.

6 Press ^/∨ to exit from the set menu.

The front panel display changes in the following order:

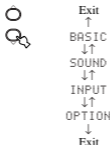

■ Basic menu operation sequence

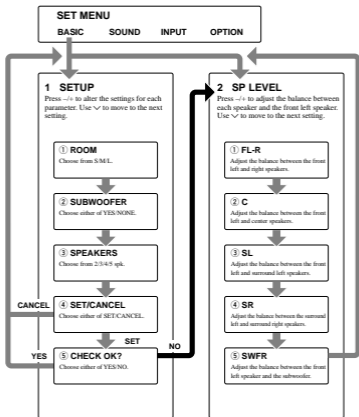

- After altering the "1 SETUP" parameters, readjust the output levels of the speakers at "2 SP LEVEL".
- See pages 40 – 45 for a detailed explanation of the "SOUND", "INPUT" and "OPTION" menus.

Setting the unit to match your speaker system

Follow the instructions below to set the amplifier output to match the size of your room and speakers. Press \wedge/\vee to cycle through parameters 1 through 4, and $-/+$ to alter the parameter setting.

Factory default settings are highlighted.

① ROOM

Settings: **S, M, L**

Select the size of the room you have installed your speakers in. Roughly speaking, the room sizes are defined as follows:

S: 3.6 x 2.8 m, 10 m²

M: 4.8 x 4.0 m, 20 m²

L: 6.3 x 5.0 m, 30 m²

② SUBWOOFER















Settings: **YES, NONE**

Select YES if you have a subwoofer in your system, or NONE if you do not.

③ SPEAKERS

Settings: 2, 3, 4, **5** (spk)

Select the number of speakers connected in your speaker configuration. This number does not include your subwoofer.

Setting	Display	Speaker
2spk	 	Front L/R
3spk	  	Front L/R, Center
4spk	   	Front L/R, Surround L/R
5spk	    	Front L/R, Center, Surround L/R

④ SET or CANCEL

Select SET to confirm the changes you made. Select CANCEL to exit SETUP MENU without altering any of the unit settings. The unit will output a test tone to the speakers (see ⑤).

⑤ Use the test tone to check the speaker levels.

When you select SET in ④, the display changes to "CHECK:TestTone" for a few seconds, and the unit outputs a test tone to each of the speakers in turn twice. When the test tone begins, the display changes to "CHECK OK?--YES".

If the test tone is output at the same volume from all of the speakers, select "CHECK OK?--YES". Press \vee to exit from the SETUP menu.

If the volume of the test tone varies between speakers, press $-/+$ to change the display to "NO".

Note

- The indicator of the speaker currently outputting the test tone flashes on the front panel display.

SP LEVEL

(Setting speaker output levels)

Use this menu to compare and adjust the test tone output from each speaker to the output from the front left (or surround left) speaker so that the volume level for all speakers is identical. Press \wedge/\vee to select a speaker, then adjust the balance using $-/+$.

Note

- The unit outputs the test tone from the selected speaker and the front left (or surround left) speaker in turn. The indicator of the speaker currently outputting the test tone flashes on the front panel display.

① FL-R

Adjust the balance between the front left and right speakers.

② C

Adjust the balance between the front left and center speakers.

③ SL

Adjust the balance between the front left and surround left speakers.

④ SR

Adjust the balance between the surround left and surround right speakers.

⑤ SWFR

Adjust the balance between the front left speaker and the subwoofer.



- You can also balance the speaker levels using test tone by pressing TEST on the remote control.

PLAYBACK

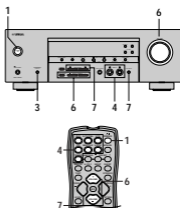

- 1 Press **STANDBY/ON** (or **POWER** on the remote control) to turn on the power.



- 2 Turn on the video monitor connected to this unit.

- 3 Press **SPEAKERS A/B/OFF** on the front panel to select the front speakers you want to use.



- 4 Press **INPUT** <|/> repeatedly (or one of the input selector buttons on the remote control) to select the input you desire. The selected input source name and input mode appear on the front panel display for a few seconds.

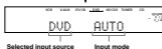

- 5 Start playback or select a broadcast station on the source component. Refer to the operation instructions for the component.

- 6 Adjust the volume to the desired level.

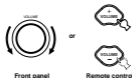

If desired, use **TONE CONTROL** and **BASS/TREBLE** +/- . These controls only effect the sound from the front speakers.



Notes

- If you increase or decrease the high-frequency or the low-frequency sound to an extreme level, the tonal quality from the center and surround speakers may not match that of the front left and right speakers.
- If you have connected a recording component to the VCR OUT, or MD/CD-R OUT jacks, and you notice distortion or low volume during playback from other components, try turning on the recording component.

7 Select a sound field program if desired.

Press PROGRAM <D>/> (or PROG -/+) on the remote control) to select a sound field program. See pages 25 - 31 for details about sound field programs.

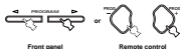

■ Selecting the 6CH INPUT

Press 6CH INPUT until "6CH INPUT" appears on the front panel display.



Note

- If "6CH INPUT" is shown on the front panel display, no other source can be played. To select another input source, first press 6CH INPUT so that "6CH INPUT" disappears from the front panel display.

■ Playing video sources in the background

You can combine a video image from a video source with a sound from an audio source. For example, you can enjoy listening to classical music while having beautiful scenery from the video source on the video monitor.

Use the input selector buttons to select a video source, then select an audio source.

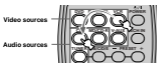

■ To mute the sound

Press MUTE on the remote control.

"MUTE" blinks on the front panel display. To resume audio output, press MUTE again.



- You can also cancel mute by pressing VOLUME +/-, etc.
- You can adjust the muting level (see page 45).

■ Night listening mode

This mode reproduces dialogue clearly while reducing the volume of loud sound effects for easier listening at low volumes or at night.

Press NIGHT on the remote control.

The NIGHT indicator in the front panel display lights up. Press NIGHT once more to return to normal reproduction.



- You can use night listening mode with any of the sound field programs.
- Night listening mode may vary in effectiveness depending on the input source and surround sound settings you use.

■ When you have finished using this unit

Press STANDBY/ON (POWER on the remote control) to set this unit in standby mode.



Input modes and indications

This unit is equipped with 2 types of input jacks. Do the following to select the type of input signals you want to use.

Press **INPUT MODE** repeatedly until the desired input mode is shown on the front panel display.

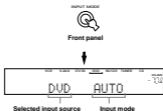

- AUTO** Automatically selects input signals in the following order:
 1) Digital signals*
 2) Analog signals
- DTS** Selects only digital signals encoded in DTS. If no DTS signals are input, no sound is output.
- ANALOG** Selects only analog signals. If no analog signals are input, no sound is output.

* If this unit detects a Dolby Digital or DTS signal, the decoder automatically switches to the appropriate sound field program.



- You can adjust the default input mode on this unit (see page 44).

Notes

- When you play DTS encoded CD/LDs with the input mode set to AUTO:
 - This unit automatically switches to the DTS decoding mode. The unit remains in DTS mode (and the "dts" indicator may flash) for up to 30 seconds after playback of the DTS source is complete. To manually release the DTS mode, press **INPUT MODE** to reselect AUTO.
 - The DTS decoding mode may be released if search or skip operations are performed for more than 30 seconds. To prevent this, press **INPUT MODE** to select DTS.
- If the digital output data of the player has been processed in any way, you may not be able to perform DTS decoding even if you make a digital connection between this unit and the player.

Selecting a sound field program

You can enhance your listening experience by selecting sound field programs. For details about each program, see pages 28 – 31.

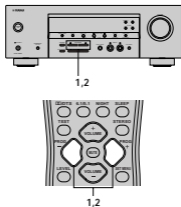

- 1 Press **PROGRAM** \leftarrow/\rightarrow (or **PROG** \rightarrow +) on the remote control) to select the desired program.

The name of the selected program appears on the front panel display.



- Select a program based on your listening preference. Program names are just for reference.

- 2 After selecting the desired program, press the same button repeatedly to cycle through sub-programs if available.

Example: Pressing **MOVIE 2** repeatedly switches the sub-program between "Adventure" and "General".

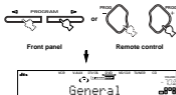

Notes

- There are 9 programs with sub-programs available with this unit. However, the selection depends on the input signal format and not all sub-programs can be used with all input signal formats.
- You cannot use the digital sound field processor with a source connected to the 6CH INPUT jacks of this unit or when the unit is reproducing a digital source with a sampling frequency greater than 48 kHz.
- The acoustics of your listening room affect sound field programs. Minimize sound reflections in your room to maximize the effect created by the program.
- When you select an input source, this unit automatically selects the last sound field program used with that source.
- When you set this unit in standby mode, it stores the current source and sound field program in memory and automatically selects them when you turn on the power again.
- If the unit receives a Dolby Digital or DTS signal when the input mode is set to AUTO, the sound field program (No. 7-9) automatically switches to the appropriate decoding program.
- When the unit is reproducing a monaural source with PRO LOGIC or PRO LOGIC Enhanced, or PRO LOGIC II Movie, no sound is output from the front and surround speakers. Sound can only be heard from the center speaker. (If "LA CENTER" on the set menu is set to NONE, the center channel sound is output from the front speakers.)

■ Selecting PRO LOGIC or PRO LOGIC II

You can listen to 2-channel sources decoded into four discrete channels by selecting PRO LOGIC or five discrete channels by selecting PRO LOGIC II in program No. 9 (refer to the list on page 30).

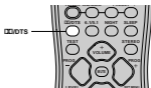

1 Select a 2-channel source and start playback on the source component.

2 Press **DTS**.

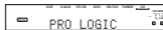

The display cycles as follows each time you press

DTS:

PRO LOGIC→PRO LOGIC Enhanced→PRO LOGIC II Movie→PRO LOGIC II Music→PRO LOGIC→—



• You can select PRO LOGIC, PRO LOGIC Enhanced, PRO LOGIC II Movie, and PRO LOGIC II Music by pressing PROGRAM <J / > on the front panel repeatedly.

■ Playing Dolby Digital EX or DTS ES material

Press 6.1/5.1 to turn on the Dolby Digital + Matrix 6.1 or DTS + Matrix 6.1 decoder.



(Example)

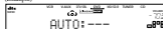

The display changes AUTO→Matrix 6.1→OFF each time 6.1/5.1 is pressed.

AUTO: Automatically switches Dolby Digital + Matrix 6.1 and DTS + Matrix 6.1 depending on the signal. Virtual surround back speaker does not work for 5.1-channel sources.

Matrix 6.1: Produces 6-channel playback of the input source using the Matrix 6.1 decoder. The virtual surround back speaker can be used when playing a 5.1-channel source.

OFF: Virtual surround back speaker does not work.

Notes

- Some 6.1-channel compatible discs do not have a signal (flag) that this unit can automatically detect. Select "Matrix 6.1" to play these kinds of discs with 6.1-channel sound.
- 6.1-channel playback is not possible even if you press 6.1/5.1 in the following cases:
 - When effects are turned off.
 - When the source connected to the 6CH INPUT jacks is being played.
 - When the unit is reproducing a Dolby Digital KARAOKE source.
 - When headphones are connected to the PHONES jack.
- The 6.1/5.1 setting resets to AUTO when you turn the unit power off.

■ Virtual CINEMA DSP

With Virtual CINEMA DSP, you can enjoy all sound field programs without surround speakers. It creates virtual speakers to reproduce a natural sound field. You can listen to virtual CINEMA DSP by setting "1C SURR" in the set menu to NONE. Sound field processing changes to Virtual CINEMA DSP automatically.

Note

- Virtual CINEMA DSP will not activate, even when 1C SURR is set to "NONE" (see page 42) in the following cases:
 - When the 5ch Stereo, DOLBY DIGITAL, Pro Logic, Pro Logic II, or DTS program is selected.
 - When the sound effect is turned off.
 - When 6CH INPUT is selected as the input source.
 - When a digital signal with a sampling frequency greater than 48 kHz is input to this unit.
 - When using the test tone.
 - When connecting the headphones.

■ To listen with headphones (SILENT CINEMA)

The SILENT CINEMA mode allows you to enjoy multi-channel music or movie sound, including Dolby Digital and DTS surround, through ordinary headphones. SILENT CINEMA activates automatically whenever you connect headphones to the PHONES jack while listening to CINEMA DSP or HiFi DSP sound field programs. The "SILENT CINEMA" indicator lights up on the front panel display. (If the sound field programs are off, you listen with normal stereo reproduction.)

Notes

- This feature is not available when 6CH INPUT is selected or the unit is receiving a digital signal with a sampling frequency greater than 48 kHz.
- The sound from the LFE channel will be mixed and output from the headphones.

■ Normal stereo reproduction

Press **STEREO** to turn off the sound effect for normal stereo reproduction.

Press **STEREO** again to turn the sound effect back on.



Notes

- If you turn off the sound effects, no sound is output from the center speaker or surround speakers.
- If you turn off the sound effects while the unit is reproducing sound from a Dolby Digital or DTS signal, the dynamic range of the signal is automatically compressed and the unit will mix the sounds of the center and surround speaker channels and output them from the front speakers.
- The volume may be greatly reduced when you turn off the sound effects or if you set "SOUND 4 D. RANGE (dynamic range)" on the set menu to MIN. In this case turn on the sound effect.



- During stereo reproduction, you can display information such as the type, format and sampling frequency of the signal input from the components connected to this unit.

(While playing a source)

- Press \wedge / \vee to display the information about the input signal.



- (Format): The display shows the signal format. When the unit cannot detect a digital signal it automatically switches to analog input.
- in: The display shows the number of input signal source channels, as follows: For multi-channel soundtrack such as front 3 channels, surround 2 channels and LFE, the display shows "3/2 LFE".
- fs: The display shows the sampling frequency. When the unit is unable to detect the sampling frequency "Unknown" shows in the front panel display.
- rate: The display shows the bit rate. When the unit is unable to detect the bit rate "Unknown" shows in the front panel display.
- flg: The display shows the flag - data encoded in a DTS or Dolby Digital signal that causes this unit to automatically switch to the appropriate decoder for playback.

DIGITAL SOUND FIELD PROCESSING (DSP)

Understanding sound fields



A sound field is defined as the "characteristic sound reflections of a particular space". In concert halls and other music venues, we hear early reflections and reverberations as well as the direct sound produced by the artist(s). The variations in the early reflections and other reverberations among the different music venues is what gives each venue its special and recognizable sound quality.

YAMAHA sent teams of sound engineers all around the world to measure the sound reflections of famous concert halls and music venues, and collect detailed sound field information such as the direction, strength, range, and delay time of those reflections. Then we stored this enormous amount of data in the ROM chips of this unit.

■ Recreating a sound field

Recreating the sound field of a concert hall or an opera house requires localizing the virtual sound sources in your listening room. The traditional stereo system that uses only two speakers is not capable of recreating a realistic sound field. YAMAHA's DSP requires four effect speakers to recreate sound fields based on the measured sound field data. The processor controls the strength and delay time of the signals output from the four effect speakers to localize the virtual sound sources and fully encompass the listener.

HiFi DSP programs

The following list gives you a brief description of the sound fields produced by each of the sound field programs. Keep in mind that most of these are precise digital recreations of actual acoustic environments.

No.	Program	Features
1	CONCERT HALL (except China model)	A large round concert hall with a rich surround effect. Pronounced reflections from all directions emphasize the extension of sounds. The sound field has a great deal of presence, and your virtual seat is near the center, close to the stage.
	HALL IN CHINA (China model only)	A large, extremely famous concert hall in China with approx. 650 seats on the first floor and approx. 500 seats on the second floor. The clear sound field of this gorgeous and majestic hall is suited especially for classic music. Your virtual seat is near the center on the first floor.
2	JAZZ CLUB	This is the sound field at stage front in "The Bottom Line", a famous New York jazz club, that seats up to 300 people. Its wide left to right seating arrangement offers a real and vibrant sound.
3	ROCK CONCERT	The ideal program for lively, dynamic rock music. The data for this program was recorded at LA's "hottest" rock club. The listener's virtual seat is at the center-left of the hall.
4	ENTERTAINMENT/ Disco	This program recreates the acoustic environment of a lively disco in the heart of a big city. The sound is dense and highly concentrated. It is also characterized by a high-energy, "immediate" sound.
	ENTERTAINMENT/ Sch Stereo	Using this program increases the listening position range. This is a sound field suitable for background music at parties, etc.

CINEMA DSP

Sound design of CINEMA DSP

Filmmakers intend for the dialog to be located right on the screen, the effect sound a little farther back, the music spread even farther back, and the surround sound around the listener. Of course, all of these sounds must be synchronized with the images on the screen.

CINEMA DSP is an upgraded version of YAMAHA DSP specially designed for movie soundtracks. CINEMA DSP integrates the DTS, Dolby Digital, and Dolby Pro Logic surround sound technologies with YAMAHA DSP sound field programs to provide a surround sound field. It recreates comprehensive movie sound design in your audio room. In CINEMA DSP sound field programs, YAMAHA's exclusive DSP processing is added to the Front left and right, and Center channels, so the listener can enjoy realistic dialogue, depth of sound, smooth transition between sound sources, and a surround sound field that goes beyond the screen.

When a DTS or Dolby Digital signal is detected, the CINEMA DSP sound field processor automatically chooses the most suitable sound field program for that signal.



In addition to the DSP, this unit is equipped with a variety of precise decoders; Dolby Pro Logic decoder for Dolby Surround sources, Dolby Pro Logic II decoder for Dolby Surround and 2-channel sources, Dolby Digital/DTS decoder for multi-channel sources and Dolby Digital + Matrix 6.1 or DTS + Matrix 6.1 decoder for adding a surround back channel (the surround back channel is outputted from virtual surround back speaker). You can select CINEMA DSP programs to optimize these decoders and the DSP sound patterns depending on the input source.

CINEMA DSP Programs

The following list gives you a brief description of the sound fields produced by each of the sound field programs. Keep in mind that most of these are precise digital recreations of actual acoustic environments. Select the sound field program that you feel sounds best regardless of the name and description given for it below.

■ For audio-video sources: No. 4 to 6

No.	Program	Features
4	ENTERTAINMENT/ Game	This program adds a deep and spatial feeling to video game sounds.
5	MUSIC VIDEO	This program lends an enthusiastic atmosphere to the sound, giving you the feeling you are at an actual jazz or rock concert.
6	TV THEATER/ Mono Movie	This program is provided for reproducing monaural video sources (such as old movies). The program produces the optimum reverberation to create sound depth using only the presence sound field.
	TV THEATER/Variety/ Sports	Though the presence sound field is relatively narrow, the surround sound field employs the sound environment of a large concert hall. This effect enhances the experience of watching various TV programs such as news, variety shows, music programs or sports programs.

■ For movie programs

No.	Program		Features
7	MOVIE THEATER 1	Spectacle	This program creates the extremely wide sound field of a 70-mm movie theater. It precisely reproduces the source sound in detail, making both the video and the sound field incredibly real. This is ideal for any kind of video source encoded with Dolby Surround, Dolby Digital or DTS (especially large-scale movie productions).
		Sci-Fi	This program clearly reproduces dialog and sound effects in the latest sound form of science fiction films, thus creating a broad and expansive cinematic space amid the silence. You can enjoy science fiction films in a virtual-space sound field that includes Dolby Surround, Dolby Digital and DTS-encoded software employing the most advanced techniques.
8	MOVIE THEATER 2	Adventure	This program is ideal for precisely reproducing the sound design of the newest 70-mm and multichannel soundtrack films. The sound field is made to be similar to that of the newest movie theaters, so the reverberations of the sound field itself are restrained as much as possible.
		General	This program is for reproducing sounds from 70-mm and multichannel soundtrack films, and is characterized by a soft and extensive sound field. The presence sound field is relatively narrow. It spatially spreads all around and toward the screen, restraining the echo effect of conversations without losing clarity.
9	Straight Decode		The built-in decoder reproduces source sounds and sound-effects precisely. No DSP effect is applied in this program.
	Enhanced Mode		This program ideally simulates the multi-surround speaker systems of the 35-mm film theaters. Dolby Pro Logic decoding, Dolby Digital decoding or DTS decoding and digital sound field processing create precise effects without altering the original sound orientation. The surround effects produced by this sound field wrap around the viewer naturally from the back to the left and right, and toward the screen.

Straight Decode

This unit is equipped with various precise decoders;

- Dolby Digital/DTS decoder for multi-channel reproduction of the original sound
- Dolby Pro Logic/Pro Logic II decoder for multi-channel reproduction of 2-channel sources

Select any of the Straight Decode modes in Program No. 9 (except for the sub-program "Enhanced") as shown in the above list to use any of these decoders for reproducing the original sound without any sound effects added. In this case, no DSP effect is applied and the DSP indicator turns off.

Note

- When playing a monaural source with a CINEMA DSP program, the source signal is directed to the center channel, and the front and surround speakers output effect sounds.

Sound field effects

The 6-channel soundtracks found on 70-mm film produce precise sound field localization and rich, deep sound without using matrix processing. This unit's MOVIE THEATER programs provide the same quality of sound and sound localization that 6-channel soundtracks do. The built-in Dolby Digital or DTS decoder brings the professional-quality sound designed for movie theaters into your home. With this unit's MOVIE THEATER programs, you can use Dolby Digital or DTS technology to recreate a dynamic sound that gives you the feeling of being in a public theater.

■ Dolby Digital/DTS + DSP sound field effect



These programs use YAMAHA's tri-field DSP processing on each of the Dolby Digital or DTS signals for the front, left surround, and right surround channels. This processing enables this unit to reproduce the immense sound field and surround expression of a Dolby Digital- or DTS-equipped movie theater without sacrificing the clear separation of all channels.

■ Dolby Digital/DTS + Matrix 6.1 + DSP sound field effect

These programs provide you with the maximum experience of the spacious surround effects by adding an extra surround back DSP sound field created from the virtual surround back speaker.

■ Dolby Pro Logic + DSP sound field effect



Most movie material has 4-channel (left, center, right, and surround) sound information encoded by Dolby Surround matrix processing and stored on the left and right tracks. These signals are processed by the Dolby Pro Logic decoder. The MOVIE THEATER programs are designed to recreate the spaciousness and delicate nuances of sound that tend to be lost in the encoding and decoding processes.

■ Dolby Pro Logic II

Dolby Pro Logic II decodes Dolby Surround software into 5 discrete full-range channels (3 channels in front and 2 channels in surround). There are 2 modes; MOVIE for movies and MUSIC for 2-channel audio sources.

TUNING

There are 2 methods of tuning; automatic and manual. Automatic tuning is effective when station signals are strong and there is no interference.

Automatic tuning

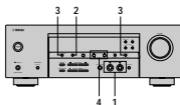

- 1 Press **INPUT** | / **T** (or **TUNER** on the remote control) to select **TUNER** as the input source.



Front panel



Remote control

- 2 Press **FM/AM** to select the reception band. "FM" or "AM" appears on the front panel display.



FM or AM

- 3 Press **TUNING MODE (AUTO/MAN'L MONO)** so that the "AUTO" indicator lights up on the front panel display.



AUTO
Lights up

If the colon (:) appears on the front panel display, tuning is not possible. Press **PRESET/TUNING (EDIT)** to turn it off.



- 4 Press **PRESET/TUNING** | / **H** once to begin automatic tuning.

Press **H** to tune in to a higher frequency, or press **L** to tune in to a lower frequency.

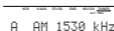

When the unit is tuned in to a station, the "TUNED" indicator lights up and the frequency of the station received is shown on the front panel display.

Manual tuning

If the signal from the station you are trying to select is weak, tune in to it manually.

- 1 Select **TUNER** and the reception band following steps 1 and 2 described in "Automatic tuning" at left.
- 2 Press **TUNING MODE (AUTO/MAN'L MONO)** until the "AUTO" indicator disappears from the front panel display.



AUTO
Disappears

If the colon (:) appears on the front panel display, tuning is not possible. Press **PRESET/TUNING (EDIT)** to turn it off.

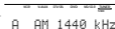

- 3 Press **PRESET/TUNING** | / **H** to tune in to the desired station manually. Hold down the button to continue searching.



Note

- Manually tuning in to an FM station will automatically change the reception mode to monaural to increase the signal quality.

Presetting stations

■ Automatically presetting FM stations

You can use the automatic preset tuning feature to store FM stations. This function enables the unit to automatically tune in to FM stations with strong signals, and to store up to 40 (8 stations in 5 groups, A1 through E8) of those stations in order. You can then recall any preset station easily by selecting the preset number.

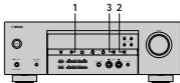

- 1 Press FM/AM to select the FM band.

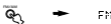

- 2 Press TUNING MODE (AUTO/MAN'L MONO) until the "AUTO" indicator lights up on the front panel display.



- 3 Press and hold MEMORY (MAN'L/AUTO FM) for more than 3 seconds.

The preset number, the "MEMORY" and "AUTO" indicators flash. After about 5 seconds, automatic presetting starts from the frequency currently displayed and proceeds toward the higher frequencies.

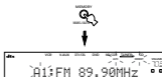

When automatic preset tuning is completed, the front panel display shows the frequency of the last preset station.

Notes

- Any stored station data existing under a preset number is cleared when you store a new station under that preset number.
- If the number of the received stations does not reach 40 (E8), automatic preset tuning has automatically stopped after searching all stations.
- Only FM stations with sufficient signal strength are stored automatically by automatic preset tuning. If the station you want to store is weak in signal strength, tune in to it manually in the manual mode, and store it by following the procedure described in "Manually presetting stations" on page 34.

Automatic preset tuning options

You can select the preset number from which this unit will store FM stations and/or begin tuning toward lower frequencies.

After pressing MEMORY in step 3:

- Press A/B/C/D/E, then PRESET/TUNING I / h to select the preset number under which the first station will be stored. Automatic preset tuning will stop when stations have all been stored up to E8.
- Press PRESET/TUNING (EDIT) to turn off the colon (:) and then press PRESET/TUNING I to begin tuning toward lower frequencies.

Memory back-up

The memory back-up circuit prevents the stored data from being lost even if this unit is set in the standby mode, the power cord is disconnected from the AC outlet, or the power supply is temporarily cut due to power failure. However, if the power is cut for more than one week, the preset stations may be cleared. If so, store the stations again by using the presetting station methods.

Manually presetting stations

You can store up to 40 stations (8 stations x 5 groups) manually.

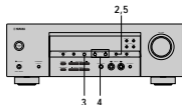

1 Tune into a station.

See page 32 for tuning instructions.

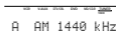

When tuned in to a station, the front panel display shows the frequency of the station received.

2 Press MEMORY (MAN'L/AUTO FM).

The "MEMORY" indicator flashes for about 5 seconds.

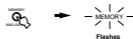

3 Press A/B/C/D/E repeatedly to select a preset station group (A to E) while the "MEMORY" indicator is flashing.

The group letter appears. Check that the colon (:) is showing on the front panel display.

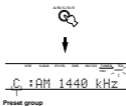

4 Press PRESET/TUNING I / h to select a preset station number (1 to 8) while the "MEMORY" indicator is flashing.

Press h to select a higher preset station number. Press I to select a lower preset station number.



5 Press MEMORY (MAN'L/AUTO FM) on the front panel display while the "MEMORY" indicator is flashing.

The station band and frequency appear on the front panel display with the preset group and number you have selected.



Shows the displayed station has been stored as C3.

6 Repeat steps 1 to 5 to store other stations.

Notes

- Any stored station data existing under a preset number is cleared when you store a new station under that preset number.
- The reception mode (stereo or monaural) is stored along with the station frequency.

Selecting preset stations

You can tune any desired station simply by selecting the preset station number under which it was stored.

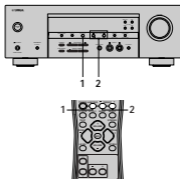

- 1 Press A/B/C/D/E (or A/B/C/D/E on the remote control) to select the preset station group. The preset group letter appears on the front panel display and changes each time you press A/B/C/D/E.



- 2 Press PRESET/TUNING | /h (or PRESET +/- on the remote control) to select a preset station number (1 to 8).

The preset group and number appear on the front panel display along with the station band, frequency and the "TUNED" indicator lights up.



C3:AM 1440 kHz

Exchanging preset stations

You can exchange the assignment of two preset stations with each other. The example below describes the procedure for exchanging preset station "E1" with "A5".

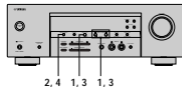

- 1 Select preset station "E1" using A/B/C/D/E and PRESET/TUNING | /h. See "Selecting preset stations" at left.
- 2 Press and hold PRESET/TUNING (EDIT) for more than 3 seconds. "E1" and the "MEMORY" indicator flash on the front panel display.



- 3 Select preset station "A5" using A/B/C/D/E and PRESET/TUNING | /h. "A5" and the "MEMORY" indicator flash on the front panel display.

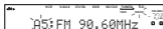

- 4 Press PRESET/TUNING (EDIT) again. The stations stored at the two preset assignments are exchanged.



Shows the exchange of stations has been completed.

RECEIVING RADIO DATA SYSTEM STATIONS

Radio Data System is a data transmission system used by FM stations in many countries.

Radio Data System data contains a variety of information such as PS (Program Service name), PTY (Program Type), RT (Radio Text), CT (Clock Time), EON (Enhanced Other Networks), and others.

Description of Radio Data System data

This unit can receive, PS, PTY, RT, CT, and EON data when tuned to stations broadcasting Radio Data System.

■ PS (Program Service name) mode:

The name of the Radio Data System station being received is displayed.

■ PTY (Program Type) mode:

There are 15 program types used to classify Radio Data System stations.

NEWS	News
AFFAIRS	Current affairs
INFO	General information
SPORT	Sports
EDUCATE	Education
DRAMA	Drama
CULTURE	Culture
SCIENCE	Science
VARIED	Light entertainment
POP M	Pop
ROCK M	Rock
M.O.R. M	Middle-of-the-road music (easy-listening)
LIGHT M	Light classics
CLASSICS	Serious classics
OTHER M	Other music

■ RT (Radio Text) mode:

Information about the program (such as the title of the song, name of the singer, etc.) on the Radio Data System station being received is displayed using a maximum of 64 alphanumeric characters, including the umlaut symbol. Any other characters used in RT data are displayed with under-bars.

■ CT (Clock Time) mode:

The current time is displayed and updated every minute. "CT WAIT" may appear if the data is accidentally cut off.

■ EON (Enhanced Other Networks):

Refer to the following page.

Changing the Radio Data System mode

This unit provides four modes for displaying Radio Data System data. The PS, PTY, RT and/or CT mode indicators that correspond to the Radio Data System data services offered by the station light up on the front panel display when an Radio Data System station is being received. Press **FREQ/TEXT** repeatedly to cycle the display through the Radio Data System data offered by the transmitting station in the order shown below.

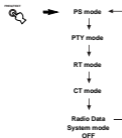

Notes

- Do not press **FREQ/TEXT** when an Radio Data System station is being received until one or more Radio Data System mode indicators light up on the front panel display. You cannot change the mode if you press this button prior to this. This is because this unit has not finished receiving all of the Radio Data System data on the station.
- Radio Data System data not offered by the station cannot be selected.
- This unit cannot utilize the Radio Data System data service if the signal received is not strong enough. In particular, the RT mode requires a large amount of data, so it is possible that the RT mode may not be displayed even if other Radio Data System modes (PS, PTY, etc.) are displayed.
- Sometimes, Radio Data System data cannot be received in poor reception conditions. If this is the case, press **TUNING MODE** so that the "AUTO" indicator disappears from the front panel display. Although this will change the reception mode to monaural, Radio Data System data may be displayed when you change the display to Radio Data System mode.
- If the signal strength is weakened by external interference during the reception of an Radio Data System station, the Radio Data System data service may cut off suddenly and "...WAIT" will appear on the front panel display.

PTY SEEK function

If you select the desired program type, the unit automatically searches all preset Radio Data System stations that are broadcasting a program of the required type.

1 Press PTY SEEK MODE to set the unit in PTY SEEK mode.

The program type of the station the unit is currently receiving, or "NEWS" flashes on the front panel display.

To exit from the PTY SEEK mode, press PTY SEEK MODE again.

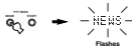

2 Press PRESET/TUNING I / H to select the desired program type.

The selected program type appears on the front panel display.



3 Press PTY SEEK START to begin searching all preset Radio Data System stations.

The selected program type flashes and the "PTY HOLD" indicator lights up on the front panel display while the unit is searching for stations.

To cancel searching, press PTY SEEK START again.



- The unit will stop searching if a station that is broadcasting a program of the required type is found.
- If the station found is not the desired one, the unit begins searching for another station that is broadcasting a program of the same type.

EON function

This function uses the EON data service on the Radio Data System station network. If you select the desired program type (NEWS, INFO, AFFAIRS or SPORT), the unit automatically searches for all preset Radio Data System stations that are scheduled to broadcast a program of the required type and switches from the station being currently received to the new station when the broadcast starts.

Note

- This function can only be used when an Radio Data System station that offers the EON data service is being received. When the unit is tuned to such a station, the "EON" indicator lights up on the front panel display.

1 Check that the "EON" indicator lights up on the front panel display.

If the "EON" indicator does not light up, tune in to another Radio Data System station so that the "EON" indicator lights up.

2 Press EON repeatedly to select the desired program type (NEWS, INFO, AFFAIRS or SPORT).

The selected program type name appears on the front panel display.



- If a preset Radio Data System station of the selected program type starts broadcasting, the unit will automatically switch from the program being currently received to that program. (EON indicator flashes.)
- When broadcasting of the required program ends, the unit returns to the previous station (or another program on the same station).

■ To cancel this function

Press EON repeatedly until the program type name disappears from the front panel display.

SLEEP TIMER

Use this feature to automatically set this unit in the standby mode after a certain amount of time. The sleep timer is useful when you are going to sleep while this unit is playing or recording a source.

The sleep timer can only be set with the remote control.

y By connecting a commercially available timer to this unit, you can also set a wake-up timer. Refer to the operation instructions of the timer.

■ Setting the sleep timer



1 Select a source and start playback on the source component.

2 Press **SLEEP** repeatedly to set the amount of time.

Each time you press **SLEEP**, the front panel display changes as shown below. The **SLEEP** indicator flashes while switching the amount of time for sleep timer.

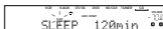
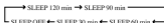

3 The "**SLEEP**" indicator lights up on the front panel display after the sleep timer has been set.

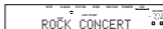

■ Canceling the sleep timer

Press **SLEEP** repeatedly until "**SLEEP OFF**" appears on the front panel display.

After a few seconds, "**SLEEP OFF**" disappears, and the "**SLEEP**" indicator goes off.

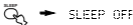

y The sleep timer setting can also be canceled by pressing **POWER** on the remote control (or **STANDBY.ON** on the front panel) to set this unit to the standby mode.

RECORDING

Recording adjustments and other operations are performed on other recording components. Refer to the operation instructions for these components for details on their operation.

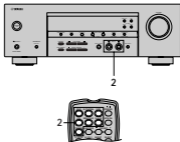

- 1 Turn on the power of this unit and all connected components.
- 2 Select the source component you want to record from.

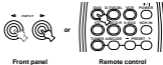

- 3 Start playback (or select a broadcast station) on the source component.
- 4 Start recording on the recording component.

Notes

- Do a test recording before you start an actual recording.
- When this unit is set in the standby mode, you cannot record between other components connected to this unit.
- The setting of TONE CONTROL, VOLUME, "SP LEVEL" (page 21) and programs does not affect the recorded material.
- A source connected to the 6CH INPUT jacks of this unit cannot be recorded.
- A given input source is not output on the same REC OUT channel. (For example, the signal input from VCR 1 IN is not output on VCR 1 OUT.)
- Check the copyright laws in your country to record from records, CDs, radio, etc. Recording of copyrighted material may infringe copyright laws.

If you playback a video source that uses scrambled or encoded signals to prevent it from being dubbed, the picture itself may be disturbed due to those signals.

SET MENU

You can set the following parameters on the set menu to obtain a better sound from the unit. Change the settings to reflect the needs of your listening environment.

Set menu list

The set menus are divided by use and function into the 4 categories listed here.

■ BASIC MENU

The BASIC MENU contains the basic parameters that you must set before using this unit. It consists of the following menus. See pages 19 – 21 for a detailed explanation.

1 SETUP

2 SP LEVEL (Speaker level)

■ SOUND MENU

The SOUND MENU contains parameters for altering sound output. It consists of the following menus that you can use to alter the quality and tone of the sound output by the system.

1 SPEAKER SET

2 SP DISTANCE (Speaker distance)

3 LFE LEVEL (Low frequency effect level)

4 D. RANGE (Dynamic range)

5 CENTER GEQ (Center graphic equalizer)

6 HP TONE CTRL (Headphone tone control)

■ INPUT MENU

The INPUT MENU contains parameters concerned with signal input. It consists of the following menus that you can use to change the assignment of input jacks.

1 I/O ASSIGN

2 INPUT MODE

■ OPTION MENU

This is a supplementary set up menu provided for your convenience. It consists of the following menus that you can use to change display brightness, protect existing settings, and perform other non-essential functions.

1 DISPLAY SET

2 MEM. GUARD

3 AUDIO MUTE

- In the descriptions for each item from the following page, the default setting is indicated in bold.

Adjusting the items on the set menu

Use the remote control to make adjustments.



- You can change set menu parameters while the unit is reproducing sound.
- You can use NEXT and SET MENU +/- on the front panel to change these settings, if the unit is not set to TUNER mode. Press NEXT to select the category or field you wish to change, and SET MENU +/- to change the parameters.

Note

- You cannot change some set menu parameters while the unit is in night listening mode.

- 1 Press SET MENU to enter the set menu.



- 2 Press ^ / v repeatedly to select the desired menu.

- 3 Press -/+ to enter the selected menu.

- 4 Press ^ / v repeatedly to select the item you want to adjust.



- By pressing SET MENU repeatedly, you can select items in the same order as when pressing v.

- 5 Press \rightarrow / \leftarrow once to enter the setup mode of the selected item.

The last setting you adjusted appears on the front panel display.

Depending on the menu item, press \wedge / \vee to select a sub item.



- 6 Press \rightarrow / \leftarrow repeatedly to change the menu item setting.



- 7 To exit, press \wedge / \vee repeatedly until the menu disappears.



Memory back-up

The memory back-up circuit prevents the stored data from being lost even if this unit is in standby mode. However, if the power cord is disconnected from the AC outlet, or the power supply is cut for more than one week, the stored data will be lost. If this happens, adjust the items again.

The BASIC and SOUND menus

The "BASIC" menu allows you to easily set the "SOUND 1 SPEAKER SET" and "SOUND 2 SP DISTANCE" parameters. It is not necessary to reset any of the parameters in the "BASIC" menu, but you can access more detailed parameters in the "SOUND" menu if you wish.

Note

- After altering parameters in the "SOUND" menu, if you select "BASIC 1 SETUP" and then select "SET", the parameters from the "SOUND" menu alter in response to any changes you make in "BASIC 1 SETUP". Do not enter the "BASIC 1 SETUP" menu unless you wish to change these settings. If you accidentally enter the "BASIC 1 SETUP" menu, select CANCEL to return to the "BASIC" menu (page 19).

SOUND 1 SPEAKER SET (speaker mode settings)

Use this feature to select suitable output modes for your speaker configuration.

Note

- Some menu item settings have no effect when the unit is reproducing a source with a digital signal sampling frequency greater than 48 kHz.

■ 1A CENTER (center speaker mode)

If you add a center speaker to your speaker configuration, this unit can provide better dialog localization for several listeners and superior synchronization of sound and images.

Choices: LRG (large), SML (small), NON (none)

LRG

Select this if you have a large center speaker. The unit directs the entire range of the center channel signal to the center speaker.

SML

Select this if you have a small center speaker. The unit directs the low-frequency signals (90 Hz and below) of the center channel to the speakers selected with "1D BASS".

NON

Select this if you do not have a center speaker. The unit directs all of the center channel signal to the front left and right speakers.

■ 1B FRONT (front speaker mode)

Choices: **LRG** (large), **SML** (small)

LRG

Select this if you have large front speakers. The unit directs the entire range of the front left and right channel signals to the front left and right speakers.

SML

Select this if you have small front speakers. The unit directs the low-frequency signals (90 Hz and below) of the front channel to the speakers selected with "1D BASS".

■ 1C SURR (surround speaker mode)

Choices: **LRG** (large), **SML** (small), **NON** (none)

LRG

Select this if you have large surround left and right speakers. The entire range of the surround channel signal is directed to the surround left and right speakers.

SML

Select this if you have small surround left and right speakers. The low-frequency signals (90 Hz and below) of the surround channel are directed to the speakers selected with "1D BASS".

NON

Select this if you do not have surround speakers. This unit is set in the virtual CINEMA DSP mode when you select **NON** for "1C SURR".

■ 1D BASS (bass out mode)

LFE signals carry low-frequency effects when this unit decodes a Dolby Digital or DTS signal. The Low-frequency signals can be directed to both front left and right speakers, and to the subwoofer (subwoofer can be used for both stereo reproduction and the sound field program).

Choices: **SWFR** (subwoofer), **FRNT** (front), **BOTH**

SWFR

Select **SWFR** if you connect a subwoofer. LFE and low-frequency signals from other channels are directed to the subwoofer according to the speaker settings.

FRNT

Select **FRNT** if you do not use a subwoofer. LFE and low-frequency signals from other channels are directed to the front speakers according to the speaker settings (even if you have previously set the front speakers to **SML**).

BOTH

Select **BOTH** if you connect a subwoofer and you want to output low-frequency signals from front channels to both front speakers and the subwoofer. LFE and low-frequency signals from other channels are directed to the subwoofer according to the speaker settings. Use this function to reinforce low-frequency signals using the subwoofer when playing back source such as CDs.

Note

- When you select **FRNT** for "1D BASS", the unit directs the low-frequency signals (90 Hz and below) of the front channel to the front speakers even if you select **SML** for the front speaker mode.

SOUND 2 SP DISTANCE (speaker distance)

Use this feature to manually input the distance of each speaker and adjust the delay applied to respective channel. Ideally, each speaker should be the same distance from the main listening position. However, this is not possible in most home situations. Thus, a certain amount of delay must be applied to the sound from each speaker so that all sound will arrive at the listening position at the same time.

- 1 Press \wedge / \vee to select "UNIT".
- 2 Press \rightarrow / \leftarrow to select the unit "meters" or "feet" to be used in setting.
- 3 Press \wedge / \vee to select a speaker.
- 4 Press \rightarrow / \leftarrow to set the distance.
Press \rightarrow for higher values and \leftarrow for lower values.



■ Setting by "meters"

Control range: 0.3 to 24.0 m (for front L/R, center, surround L/R)

Initial settings: 3.00 m (for front L/R, center, surround L/R)

■ Setting by "feet"

Control range: 1.0 to 80.0 ft (for front L/R, center, surround L/R)

Initial settings: 10.0 ft (for front L/R, center, surround L/R)

Note

- No delay will be set if you set the same distance for the front L/R and center, or the surround L/R.

SOUND 3 LFE LEVEL

Use to adjust the output level of the LFE (low-frequency effect) channel according to the capacity of your subwoofer or headphones. The LFE channel carries low-frequency special effects which are only added to certain scenes. This setting is effective only when this unit decodes Dolby Digital or DTS signals.

Control range:

SP LFE (Speaker) -20 to 0 dB

HP LFE (Headphone) -20 to 0 dB

Initial setting: 0 dB

- 1 Press \wedge / \vee to select the item to be adjusted.

- 2 Press \rightarrow to adjust the LFE level.

Note

- Adjust the LFE level according to the capacity of your subwoofer or headphones.

SOUND 4 D. RANGE (dynamic range)

Use this feature to adjust the dynamic range. This setting is effective only when the unit is decoding Dolby Digital signals.

Choices: MIN (minimum), STD (standard),
MAX (maximum)

MIN

Select MIN for listening to sources at low volume levels.

STD

Select STD for general use.

MAX

Select MAX for feature films.

SOUND 5 CENTER GEQ (center graphic equalizer)

Use this feature to adjust the built-in 5-band graphic equalizer so that the center speaker tonal quality matches that of the left and right front speakers. You can select the 100 Hz, 300 Hz, 1 kHz, 3 kHz, or 10 kHz frequencies.

Control range (dB): -6 to +6

Initial setting: 0 dB for 5-band

- 1 Press \checkmark to select a higher frequency and \wedge to select a lower frequency.
- 2 Press $-/+$ to adjust the level of that frequency.

Note

- You can monitor the center speaker sound while adjusting this parameter by using the test tone. Press TEST before starting the foregoing procedure. Once you begin this procedure, the test tone remains at the center speaker and you can hear how the sound changes as you adjust the various frequency levels. To stop the test tone, press TEST.

SOUND 6 HP TONE CTRL (headphone tone control)

Use this feature to adjust the level of the bass and treble when you are using headphones.

Control range (dB):

HP BASS -6 to +3

HP TRBL (treble) -6 to +3

Initial setting:

HP BASS 0 dB

HP TRBL 0 dB

INPUT 1 I/O ASSIGN (input/output assignment)

You can assign jacks according to the component to be used if this unit's initial settings do not correspond to your needs. Change the following parameters to reassign the respective jacks and effectively connect more components. Once the inputs have been reassigned, you can select the corresponding component by using INPUT $\langle \triangleright / \triangleleft \rangle$ on the front panel or the input selector buttons on the remote control.

For COMPONENT VIDEO jacks A (1A[1A]) and B (1B[1B])

Choices: [A] VCR, V-AUX, DTV/CBL, DVD
[B] VCR, V-AUX, DTV/CBL, DVD

For OPTICAL INPUT jacks 1 (1B<1>) and 2 (1B<2>)

Choices: (1) VCR, V-AUX, DTV/CBL, DVD, MD/CD-R, CD
(2) VCR, V-AUX, DTV/CBL, DVD, MD/CD-R, CD

For COAXIAL INPUT jack 3 (1C<3>)

Choices: VCR, V-AUX, DTV/CBL, DVD, MD/CD-R, CD

Notes

- You cannot select a specific item more than once for the same type of jack.
- When you connect a component to both the COAXIAL and OPTICAL jacks, priority is given to the input signals from the COAXIAL jack.

INPUT 2 INPUT MODE (initial input mode)

Use this feature to designate the input mode for sources connected to the DIGITAL INPUT jacks when you turn on this unit (see page 24 for details about the input mode).

Choices: **AUTO**, **LAST**

AUTO

Select this setting to allow the unit to automatically detect the type of input signal and select the appropriate input mode.

LAST

Select this setting to set this unit to automatically select the last input mode used for the respective sources.

OPTION 1 DISPLAY SET**■ DIMMER**

Use this to adjust the brightness of the front panel display.

Control range: -4 to 0

OPTION 2 MEM. GUARD
(memory guard)

Use this feature to prevent accidental changes to sound field program parameter values and other system settings.

Choices: ON, **OFF**

Select ON to protect:

- Sound field program parameters
- All SET MENU items
- All speaker levels

When MEMORY GUARD is set to ON, you cannot use the test tone or select any other SET MENU items.

OPTION 3 AUDIO MUTE

Use to adjust how much the mute function reduces the output volume.

Choices: **MUTE**, -50dB, -20dB

MUTE

Completely halts all output of sound.

-50dB

Reduces the volume of the present sound output by 50 dB.

-20dB

Reduces the volume of the present sound output by 20 dB.

ADVANCED SETUP MENU

The ADVANCED SETUP menu is displayed in the front panel display.



- During the advanced setup procedure, audio output is muted.
- During the advanced setup procedure, only the **STANDBY/ON**, **STEREO (EFFECT)** and **PROGRAM <I>/<D>** buttons on the front panel are available for operation.

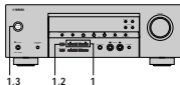

- 1 Turn off the power to this unit, and while holding down **STEREO (EFFECT)**, press **STANDBY/ON**. This unit turns on, and "PRESET" appears in the front panel display.



- 2 Press **STEREO (EFFECT)** repeatedly to toggle between the available parameters.



- 3 Press **STANDBY/ON** to confirm your selection.



This completes the advanced setup procedure. The settings you made are reflected the next time this unit's power is turned on.

■ ADVANCED SETUP menu items

Change the initial settings (indicated in bold under each parameter) to reflect the needs of your listening environment.

Factory presets PRESET

Use to reset all parameters to the factory presets (see page 53).

Choices: **CANCEL**, **RESET**

- Select **CANCEL** if you do not want this unit's parameters to be initialized.
- Select **RESET** if you want all of this unit's parameters to be initialized.

Note

- This setting does not affect ADVANCED SETUP menu item parameters.

SETTING THE SPEAKER LEVELS

Adjusting the speaker levels during playback

You can adjust the output level of each speaker while listening to sound playback.



1 Press LEVEL repeatedly to select the speaker you want to adjust.

The unit cycles through the speakers in the following order each time you press LEVEL:
FRONT L → CENTER → FRONT R →
SUR R. (surround R) → SUR L. (surround L) →
SUBWOOFER (subwoofer) → ...



- Pressing LEVEL once opens the level display. Press \wedge / \vee at this time to select a speaker.

2 Press \rightarrow / \leftarrow to adjust the speaker output level.

- The center and surround speakers can be adjusted by a maximum of -10dB ~ $+10\text{dB}$.
- The front speakers and subwoofer can be adjusted by a maximum of -20dB ~ 0dB .

Notes

- You cannot adjust speaker levels if the "SOUND 1 SPEAKER SET" parameter in the set menu is set to NONE.
- You cannot adjust the subwoofer level if the "1D BASS" parameter in "SOUND 1 SPEAKER SET" in the set menu is set to FRNT.
- If you use LEVEL to adjust speaker levels, the speaker levels you previously set with the test tone will also change.
- If you select "BASIC 1 SETUP" in the set menu and then select "SET", speaker levels change in response to any changes you make in "BASIC 1 SETUP".

Using the test tone

Use the test tone to set speaker levels so that the volume from each speaker is identical when heard from your listening position.



1 Press TEST.

The unit will output a test tone.

2 Press \wedge / \vee repeatedly to select a speaker to adjust.

Each time you press \vee , the unit will cycle through the speakers in the following order:
TEST LEFT (front L) → TEST CENTER (center) →
TEST RIGHT (front R) → TEST SUR R. (surround R) →
TEST SUR L. (surround L) → TEST
SUBWOOFER (subwoofer) → ...
(Press \wedge to cycle the speakers in the reverse order.)

3 Press \rightarrow / \leftarrow to adjust the speaker output level.

4 Press TEST when you have completed your adjustment.

The test tone halts.

Notes

- You cannot enter test mode if headphones are connected to the PHONES jack. Remove the headphones from the PHONES jack.
- You cannot adjust speaker volumes if the "SOUND 1 SPEAKER SET" parameter in the set menu is set to NONE.
- You cannot adjust the subwoofer level if the "1D BASS" parameter in "SOUND 1 SPEAKER SET" in the set menu is set to FRNT.
- If you select "BASIC 1 SETUP" in the set menu and then select "SET", speaker levels change in response to any changes you make in "BASIC 1 SETUP".



- Depending on the source the unit is reproducing, the speaker levels set with the test tone may not be to your liking. If this is the case, adjust the speaker levels while listening to the source.

EDITING SOUND FIELD PARAMETERS

Changing parameter settings

The initial sound field program settings will provide you with an excellent listening experience as they are. But you can create an original listening environment by altering some settings.

Note

- The editable parameters vary depending on the sound field program you select. Refer to the explanation for the parameter.



- 1 Select the sound field program you want to adjust.



- 2 Press \wedge / \vee to select the parameters.



- 3 Press $-/+$ to change the parameter value.



- If you press and hold $-/+$ to change the parameter value, the front panel display automatically stops at the factory preset parameter momentarily.

- 4 Repeat steps 1 through 3 if you wish to alter other parameters.

Note

- You cannot change parameter values when "OPTION 2 MEM. GUARD" is set to "ON". If you want to change the parameter values, set "OPTION 2 MEM. GUARD" to "OFF" (see page 45).

Sound field parameter descriptions

You can adjust the values of certain digital sound field parameters so the sound fields are recreated accurately in your listening room. Not all of the following parameters are found in every program.

■ DSP LEVEL

Function: This parameter adjusts the level of all the DSP effect sounds within a narrow range.

Description: Depending on the acoustics of your listening room, you may want to increase or decrease the DSP effect level relative to the level of the direct sound.

Control range: -6 dB to +3 dB

■ DELAY

Function: This parameter changes the apparent distance from the source sound by adjusting the delay between the direct sound and the first reflection heard by the listener.

Description: The smaller the value, the closer the sound source seems to the listener. The larger the value, the farther it seems. For a small room, set to a small value. For a large room, set to a large value.

Control range: 1 to 99 msec

For 5ch Stereo

Function: These parameters adjust the volume level for each channel in 5-channel stereo mode.

Control range: 0 to 100%

■ CT LEVEL (Center level)

■ SL LEVEL (Surround left level)

■ SR LEVEL (Surround right level)

For PRO LOGIC II Music

■ PANORAMA

Function: Extends the front stereo image to include the surround speakers for a wraparound effect.

Choices: OFF/ON, initial setting is OFF.

■ DIMENSION

Function: Gradually adjusts the sound field either towards the front or towards the rear.

Control range: -3 (towards the rear) to +3 (towards the front), initial setting is STD (standard).

■ CT WIDTH (Center width)

Function: Adjusts the center image from all three front speakers to varying degrees. A larger value adjusts the center image towards the front left and right speakers.

Control range: 0 (center channel sound is output only from center speaker) to 7 (center channel sound is output only from front left and right speakers), initial setting is 3.

TROUBLESHOOTING

Refer to the chart below when this unit does not function properly. If the problem you are experiencing is not listed below or if the instruction below does not help, set this unit to standby mode, disconnect the power cord, and contact the nearest authorized YAMAHA dealer or service center.

■ General

Problem	Cause	Remedy	Refer to page
This unit fails to turn on when STANDBY/ON (or POWER on the remote control) is pressed, or enters in standby mode soon after the power has been turned on.	The power cord is not connected or the plug is not completely inserted.	Connect the power cord firmly.	-
	The protection circuitry has been activated.	Make sure all speaker wire connections on this unit and on all speakers are secure and that the wire for each connection is not touching anything other than its respective connection.	16 - 17
	This unit has been exposed to a strong external electric shock (such as lightning and strong static electricity).	Set this unit in standby mode, disconnect the power cord, plug it back in after 30 seconds, then use it normally.	-
No sound.	Incorrect input or output cable connections.	Connect the cables properly. If the problem persists, the cables may be defective.	9 - 17
	No appropriate input source is selected.	Select an appropriate input source with INPUT ◀/▶ or 6CH INPUT (or the input selector buttons).	22
	The speaker connections are not secure.	Secure the connections.	16 - 17
	The front speakers to be used have not been selected properly.	Select the proper front speakers with SPEAKERS A/B/OFF.	22
	The volume is turned down.	Turn up the volume.	22
	The sound is muted.	Press MUTE or any operation buttons of this unit to cancel a mute and adjust the volume.	23
	The signals this unit cannot reproduce are being received from a source component e.g.: a CD-ROM.	Play a source whose signals this unit can reproduce.	-
The sound suddenly goes off.	The protection circuitry has been activated because of a short circuit, etc.	Check that the speaker wires are not touching each other and then turn the unit back on.	-
	The sleep timer has turned the unit off.	Turn on the power, and play the source again.	-
	The sound is muted.	Press MUTE or any operation buttons on the unit to cancel a mute and adjust the volume.	23
No sound / weak sound from particular speakers.	Incorrect cable connections.	Connect the cables properly. If the problem persists, the cables may be defective.	16 - 17
No sound from the effect speakers.	The sound effect is switched off.	Press STEREO to turn it on.	-
	A Dolby Surround, Dolby Digital or DTS decoding program is being used with material not encoded with Dolby Surround, Dolby Digital or DTS.	Select another sound field program.	25 - 27
	A digital signal with a sampling frequency of greater than 48 kHz is input to this unit.		-

Problem	Cause	Remedy	Refer to page
No sound from the center speaker.	The output level of the center speaker is set to minimum.	Raise the level of the center speaker.	21
	"SOUND 1A CENTER" on the set menu is set to NONE.	Select the appropriate mode for your center speaker.	41
	One of the HiFi DSP programs (1 to 4) has been selected (except for 5ch Stereo).	Select another sound field program.	28 - 30
	The source encoded with a Dolby Digital or DTS signal does not have a center channel signal.		-
No sound from the surround speakers.	The output level of the surround speakers is set to minimum.	Raise the output level of the surround speakers.	21
	A monaural source is being played with program 9.	Select another sound field program.	28 - 30
No sound from the subwoofer.	"SOUND 1D BASS" on the set menu is set to FRNT when a Dolby Digital or DTS signal is being played.	Select SWFR or BOTH.	42
	"SOUND 1D BASS" on the set menu is set to SWFR or FRNT when a 2-channel source is being played.	Select BOTH.	42
	The source does not contain low bass signals (90 Hz and below).		-
Poor bass reproduction.	"SOUND 1D BASS" on the set menu is set to SWFR or BOTH and your system does not include a subwoofer.	Select FRNT.	42
	The speaker mode settings (front, center or surround) on the set menu does not match your speaker configuration.	Select the appropriate position for each speaker based on the size of the speakers in your configuration.	41 - 42
A "humming" sound can be heard.	Incorrect cable connections.	Firmly connect the audio plugs. If the problem persists, the cables may be defective.	-
The volume level cannot be increased, or the sound is distorted.	The component connected to the OUT (REC) jacks of this unit is turned off.	Turn on the power to the component.	-
The sound effect cannot be recorded.	It is not possible to record the sound effect with a recording component.		-
The sound field parameters and some other settings on the unit cannot be changed.	"OPTION 2 MEM. GUARD" in the SET MENU is set to ON.	Select OFF.	45
The unit does not operate properly.	The internal microcomputer has been frozen by an external electric shock (such as lightning or excessive static electricity) or by a power supply with low voltage.	Disconnect the AC power cord from the outlet and then plug it in again after about 30 seconds.	-
"CHECK SP WIRES" appears on the front panel display.	The speaker cables are short circuited.	Make sure all speaker cables are connected correctly.	16 - 17

TROUBLESHOOTING

Problem	Cause	Remedy	Refer to page
There is noise interference from digital or radio frequency equipment, or this unit.	This unit is too close to the digital or high-frequency equipment.	Move this unit further away from such equipment.	-
The unit suddenly turns into standby mode.	The internal temperature has become too high and the overheat protection circuitry has been activated.	Wait until the unit cools down and then turn it back on.	-

Tuner

Problem	Cause	Remedy	Refer to page	
FM	FM stereo reception is noisy.	The characteristics of FM stereo broadcasts may cause this problem when the transmitter is too far away or the antenna input is poor.	Check the antenna connections. Try using a high-quality directional FM antenna.	13
			Use the manual tuning method.	32
	There is distortion, and clear reception cannot be obtained even with a good FM antenna.	There is multipath interference.	Adjust the antenna position to eliminate multipath interference.	-
	The desired station cannot be tuned in with the automatic tuning method.	The station is too weak.	Use a high-quality directional FM antenna.	-
		Use the manual tuning method.	32	
Previously preset stations can no longer be tuned in.	The unit has been disconnected for a long period.	Preset the stations again.	33	
AM	The desired station cannot be tuned in with the automatic tuning method.	The signal is weak or the antenna connections are loose.	Tighten the AM loop antenna connections and orient it for best reception.	13
			Use the manual tuning method.	32
	There are continuous crackling and hissing noises.	Noises result from lightning, fluorescent lamps, motors, thermostats and other electrical equipment.	Use an outdoor antenna and a ground wire. This will help somewhat, but it is difficult to eliminate all noise.	13
	There are buzzing and whining noises (especially in the evening).	A TV set is being used nearby.	Move this unit away from the TV.	-

Remote control

Problem	Cause	Remedy	Refer to page
The remote control does not work nor function properly.	Wrong distance or angle.	The remote control will function within a maximum range of 6 m and no more than 30 degrees off-axis from the front panel.	7
	Direct sunlight or lighting (from an inverter type of fluorescent lamp, etc.) is striking the remote control sensor of this unit.	Reposition this unit.	-
	The batteries are weak.	Replace all batteries.	3

RESETTING THE FACTORY PRESETS

If you want to reset all of your unit's parameters for any reason, do the following. This procedure completely resets ALL parameters, including the SET MENU, level, assign, and tuner presets.

Be sure this unit is in standby mode.

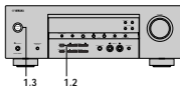

- 1 With the unit in standby mode, hold down **STEREO (EFFECT)** on the front panel and press **STANDBY/ON**.

"PRESET" appears in the front panel display.
If you are using Asia and General model, press PROGRAM </> to select "PRESET".



- To cancel the initialization procedure without making any changes, press **STANDBY/ON**.

- 2 Press **STEREO (EFFECT)** to select the desired setting.

RESET To reset the unit to its factory presets.
CANCEL To cancel without making any changes.

- 3 Press **STANDBY/ON** to confirm your selection.

If you selected "RESET", the unit is reset to its factory presets and switches to standby mode.
If you selected "CANCEL", the unit switches to standby mode and nothing is reset.

GLOSSARY

■ CINEMA DSP

Since the Dolby Surround and DTS systems were originally designed for use in movie theaters, their effect is best felt in a theater having many speakers and designed for acoustic effects. Since home conditions, such as room size, wall material, number of speakers, and so on, can differ so widely, it's inevitable that there are differences in the sound heard as well. Based on a wealth of actually measured data, YAMAHA CINEMA DSP uses YAMAHA original sound field technology to combine Dolby Pro Logic, Dolby Digital and DTS systems to provide the visual and audio experience of movie theater in the listening room of your own home.

■ Dolby Digital

Dolby Digital is a digital surround sound system that gives you completely independent multi-channel audio. With 3 front channels (left, center, and right), and 2 surround stereo channels, Dolby Digital provides 5 full-range audio channels. With an additional channel especially for bass effects, called LFE (low frequency effect), the system has a total of 5.1 channels (LFE is counted as 0.1 channel).

By using 2-channel stereo for the surround speakers, more accurate moving sound effects and surround sound environment are possible than with Dolby Surround. The wide dynamic range (from maximum to minimum volume) reproduced by the 5 full-range channels and the precise sound orientation generated using digital sound processing provide listeners with previously unheard of excitement and realism.

With this unit, any sound environment from monaural up to a 5.1-channel configuration can be freely selected for your enjoyment.

■ Dolby Pro Logic II

Dolby Pro Logic II is an improved technique used to decode vast numbers of existing Dolby Surround software. This new technology enables a discrete 5-channel playback with 2 front left and right channels, 1 center channel, and 2 surround left and right channels (instead of only 1 surround channel for conventional Pro Logic technology). A music mode is also available for 2-channel sources in addition to the movie mode.

■ Dolby Surround

Dolby Surround uses a 4 channel analog recording system to reproduce realistic and dynamic sound effects: 2 front left and right channels (stereo), a center channel for dialog (monaural), and a surround channel for special sound effects (monaural). The surround channel reproduces sound within a narrow frequency range. Dolby Surround is widely used with nearly all video tapes and laser discs, and in many TV and cable broadcasts as well. The Dolby Pro Logic decoder built into this unit employs a digital signal processing system that automatically stabilizes the volume on each channel to enhance moving sound effects and directionality.

■ DTS (Digital Theater Systems) Digital Surround

DTS digital surround was developed to replace the analog soundtracks of movies with a 6-channel digital sound track, and is now rapidly gaining popularity in movie theaters around the world. Digital Theater Systems Inc. has developed a home theater system so that you can enjoy the depth of sound and natural spatial representation of DTS digital surround in your home. This system produces practically distortion-free 6-channel sound (technically, a left, right and center channels, 2 surround channels, plus an LFE 0.1 channel as a subwoofer, for a total of 5.1 channels).

■ ITU-R

ITU-R is the radio communication sector of the ITU (International Telecommunication Union). ITU-R recommends a standard speaker placement which is used in many critical listening rooms, especially for mastering purposes.

■ LFE 0.1 channel

This channel is for the reproduction of low bass signals. The frequency range for this channel is 20 Hz to 120 Hz. This channel is counted as 0.1 because it only enforces a low frequency range compared to the full-range reproduced by the other 5 channels in a Dolby Digital or DTS 5.1 channel systems.

■ Matrix 6.1

The unit incorporates Matrix 6.1 decoder for Dolby Digital and DTS multi-channel software that enables 6.1-channel reproduction by adding the surround back channel to existing 5.1-channel format. (The surround back channel is created from surround left and right channels, and outputted from virtual surround back speaker.) With this additional channel, you can experience more dynamic and realistic moving sound especially with scenes with "fly-over" and "fly-around" effects.

■ PCM (Linear PCM)

Linear PCM is a signal format under which an analog audio signal is digitized, recorded and transmitted without using any compression. This is used as a method of recording CDs and DVD audio. The PCM system uses a technique for sampling the size of the analog signal per very small unit of time. Standing for "pulse code modulation", the analog signal is encoded as pulses and then modulated for recording.

■ Sampling frequency and number of quantized bits

When digitizing an analog audio signal, the number of times the signal is sampled per second is called the sampling frequency, while the degree of fineness when converting the sound level into a numeric value is called the number of quantized bits.

The range of rates that can be played back is determined based on the sampling rate, while the dynamic range representing the sound level difference is determined by the number of quantized bits. In principle, the higher the sampling frequency, the wider the range of frequencies that can be played back, and the higher the number of quantized bits, the more finely the sound level can be reproduced.

■ SILENT CINEMA

YAMAHA has developed a natural, realistic sound effect DSP algorithm for headphones.

Parameters for headphones have been set for each sound field so that accurate representations of all the sound field programs can be enjoyed using headphones.

■ Virtual CINEMA DSP

YAMAHA has developed a virtual CINEMA DSP algorithm that allows you to enjoy DSP sound field surround effects even without any surround speakers by using virtual surround speakers.

It is even possible to enjoy virtual CINEMA DSP using a minimal 2-speaker system that does not include a center speaker.

SPECIFICATIONS

AUDIO SECTION

- Minimum RMS Output Power for Front, Center, Surround
1 kHz, 0.9% THD, 6 Ω/8 Ω 100 W
- DIN Standard Output Power
[Europe and Asia models]
1 kHz, 0.7% THD, 4 Ω 105 W
- Maximum Power
[China, Korea and General models]
1 kHz, 10% THD, 6 Ω 110 W
- Dynamic Power
(IHF, 6/4/2 Ω) 105/135/165 W
- Frequency Response
CD, etc. to Front L/R 10 Hz to 100 kHz, -3 dB
- Total Harmonic Distortion
1 kHz, 50 W, 6 Ω, Front L/R 0.06% or less
- Signal to Noise Ratio (IHF-A Network)
CD (250 mV, shorted) to Front L/R, Effect Off 100 dB or more
- Residual Noise (IHF-A Network)
From L/R 150 μV or less
- Channel Separation (1 kHz/10 kHz)
CD, etc. (5.1 kΩ termination) to Front L/R .. 60 dB/45 dB or more
- Tone Control (Front L/R)
BASS Boost/Cut ±10 dB/100 Hz
TREBLE Boost/Cut ±10 dB/20 kHz
- Phono Output 400 mV/470 Ω
- Input Sensitivity
CD, etc. 200 mV/47 kΩ
6CH INPUT 200 mV/47 kΩ
- Output Level
OUT (REC) 200 mV/1.2 kΩ
OUTPUT SUBWOOFER 4 V/1.2 kΩ

VIDEO SECTION

- Video Signal Type NTSC or PAL
- Composite Signal Level 1 Vp-p/75 Ω
- Signal to Noise Ratio 50 dB or more
- Frequency Response (MONITOR OUT)
Video Signal 5 Hz to 10 MHz, -3 dB
Composite Signal 5 Hz to 60 MHz, -3 dB

FM SECTION

- Tuning Range 87.50 to 108.00 MHz
- 50 dB Quieting Sensitivity (IHF, 100% mod.)
Mono 2.8 μV (20.2 dBf)
- Signal to Noise Ratio (IHF)
Mono/Stereo 73 dB/70 dB
- Harmonic Distortion (1 kHz)
Mono/Stereo 0.5%/0.5%

AM SECTION

- Tuning Range 530/531 to 1710/1611 kHz

GENERAL

- Power Supply AC 230 V/50 Hz
- Power Consumption 240 W
- Standby Power Consumption 0.7 W
- Dimensions (W x H x D) 435 x 151 x 315 mm
- Weight 9 kg

*Specifications are subject to change without notice.