



# MODEL W1688 EDGE SANDER



# INSTRUCTION MANUAL

Phone: 1-360-734-3482 • On-Line Technical Support: [tech-support@shopfox.biz](mailto:tech-support@shopfox.biz)

COPYRIGHT © NOVEMBER, 2002 BY WOODSTOCK INTERNATIONAL, INC.  
WARNING: NO PORTION OF THIS MANUAL MAY BE REPRODUCED IN ANY SHAPE OR FORM WITHOUT  
THE WRITTEN APPROVAL OF WOODSTOCK INTERNATIONAL, INC.

Printed in Taiwan

# WARNING

Some dust created by power sanding, sawing, grinding, drilling, and other construction activities contains chemicals known to the State of California to cause cancer, birth defects or other reproductive harm. Some examples of these chemicals are:

- Lead from lead-based paints.
- Crystalline silica from bricks, cement, and other masonry products.
- Arsenic and chromium from chemically treated lumber.

Your risk from these exposures varies, depending on how often you do this type of work. To reduce your exposure to these chemicals: work in a well ventilated area, and work with approved safety equipment, such as those dust masks that are specially designed to filter out microscopic particles.

# TABLE OF CONTENTS

	PAGE
<b>INTRODUCTION</b> .....	2
About Your New Edge Sander .....	2
Woodstock Service and Support.....	2
Warranty and Returns .....	3
Specifications .....	3
<b>SAFETY</b> .....	4
Standard Safety Instructions .....	4-5
Additional Safety Instructions for Edge Sanders .....	6
Avoiding Potential Injuries .....	7
<b>ELECTRICAL REQUIREMENTS</b> .....	8
220V Operation .....	8
Extension Cords.....	8
Grounding .....	8
110V Operation .....	9
Extension Cords.....	9
Grounding .....	9
<b>ASSEMBLY INSTRUCTIONS</b> .....	11
Unpacking .....	11
Box Contents.....	11
Shop Preparation .....	12
Beginning .....	12
Cleaning.....	12
Feet .....	13
Main Table .....	13
Quick Release Lever .....	15
Miter Gauge .....	15
Dust Hood .....	16
Sanding Belt .....	16
Back Stop .....	18
Auxiliary Table .....	18
<b>ADJUSTMENTS</b> .....	19
Vertical Belt Tracking .....	19
Diagonal Belt Tracking.....	20
Platen-to-Roller Alignment .....	21
Belt Tension .....	22
Main Table Height .....	23
Main Table Tilt .....	24
<b>OPERATIONS</b> .....	25
Starting the Edge Sander .....	25
Platen Tilting .....	26
Vertical Sanding.....	27
Horizontal Sanding .....	29
Contour Sanding.....	30
Troubleshooting.....	31-35
<b>MAINTENANCE</b> .....	37
General .....	37
Lubrication and Cleaning .....	37
Table and Base .....	37
Sanding Belts.....	37
Wiring Diagram .....	38
<b>CLOSURE</b> .....	39
Parts Breakdown and Parts List .....	40-41

**USE THE QUICK GUIDE PAGE LABELS TO SEARCH OUT INFORMATION FAST!**





---

# INTRODUCTION

## About Your New Edge Sander

Your new **SHOP FOX®** W1688 has been specially designed to provide many years of trouble-free service. Close attention to detail, ruggedly built parts and a rigid quality control program assure safe and reliable operation.

The Model W1688 is capable of a wide variety of sanding operations. Features include a 1½ HP 110/220V single-phase motor that is prewired for 220V, a 4" dust port, a precision-ground cast iron table, a miter block, a quick release belt tensioner, and a graphite platen.

Woodstock International, Inc. is committed to customer satisfaction in providing this manual. It is our intent to make sure all the information necessary for safety, ease of assembly, practical use and durability of this product be included.

If you should have any comments regarding this manual, please feel free to contact us at:

Woodstock International, Inc.  
Attn: Technical Department  
P.O. Box 2309  
Bellingham, WA 98227

## Woodstock Service and Support

We stand behind our machines! In the event that a defect is found, parts are missing or questions arise about your machine, please contact Woodstock International Service and Support at 1-360-734-3482 or send e-mail to: [tech-support@shopfox.biz](mailto:tech-support@shopfox.biz). Our knowledgeable staff will help you troubleshoot problems, send out parts or arrange warranty returns.

# Warranty and Returns

Woodstock International, Inc. warrants all **SHOP FOX**® machinery to be free of defects from workmanship and materials for a period of 2 years from the date of original purchase by the original owner. This warranty does not apply to defects due directly or indirectly to misuse, abuse, negligence or accidents, lack of maintenance, or to repairs or alterations made or specifically authorized by anyone other than Woodstock International, Inc.

Woodstock International, Inc. will repair or replace, at its expense and at its option, the **SHOP FOX**® machine or machine part which in normal use has proven to be defective, provided that the original owner returns the product prepaid to the **SHOP FOX**® factory service center or authorized repair facility designated by our Bellingham, WA office, with proof of their purchase of the product within 2 years, and provides Woodstock International, Inc. reasonable opportunity to verify the alleged defect through inspection. If it is determined there is no defect, or that the defect resulted from causes not within the scope of Woodstock International Inc.'s warranty, then the original owner must bear the cost of storing and returning the product.

This is Woodstock International, Inc.'s sole written warranty and any and all warranties that may be implied by law, including any merchantability or fitness, for any particular purpose, are hereby limited to the duration of this written warranty. We do not warrant that **SHOP FOX**® machinery complies with the provisions of any law or acts. In no event shall Woodstock International, Inc.'s liability under this warranty exceed the purchase price paid for the product, and any legal actions brought against Woodstock International, Inc. shall be tried in the State of Washington, County of Whatcom. We shall in no event be liable for death, injuries to persons or property or for incidental, contingent, special or consequential damages arising from the use of our products.

Every effort has been made to ensure that all **SHOP FOX**® machinery meets high quality and durability standards. We reserve the right to change specifications at any time because of our commitment to continuously improve the quality of our products.

## Specifications

Motor Size .....	1½ HP 110/220V Single-Phase
Motor Speed and Cycle .....	1725 RPM / 60 Hertz
Amps .....	16/8
Sanding Belt.....	6" x 80"
Belt Speed .....	1800 FPM
Platen Size .....	6¾" x 29¾"
Dust Port .....	4"
Table Size.....	22" x 10½"
Stand .....	Cabinet Style, Powder Coated Paint
Power Transfer .....	Direct Drive
Bearings.....	Sealed & Permanently Lubricated Ball Bearings
Switch .....	Paddle ON/OFF Switch, w/Safety Lock Key
Shipping Weight .....	260 lbs.

# SAFETY

**READ MANUAL BEFORE OPERATING MACHINE.  
FAILURE TO FOLLOW INSTRUCTIONS BELOW WILL  
RESULT IN PERSONAL INJURY.**



Indicates an imminently hazardous situation which, if not avoided, **WILL** result in death or serious injury.



Indicates a potentially hazardous situation which, if not avoided, **COULD** result in death or serious injury.



Indicates a potentially hazardous situation which, if not avoided, **MAY** result in minor or moderate injury and/or damage to the machinery.

## NOTICE

This symbol is used to alert the user to useful information about proper operation of the equipment.

## Standard Safety Instructions

1. **Thoroughly read the instruction manual before operating your machine.** Learn the applications, limitations and potential hazards of this machine. Keep manual in a safe, convenient place for future reference.
2. **Keep work area clean and well lighted.** Clutter and inadequate lighting invite potential hazards.
3. **Ground all tools.** If a machine is equipped with a three-prong plug, it must be plugged into a three-hole grounded electrical receptacle or grounded extension cord. If using an adapter to aid in accommodating a two-hole receptacle, ground using a screw to a known ground.
4. **Wear eye protection at all times.** Use safety glasses with side shields or safety goggles that meet the national safety standards, while operating this machine.
5. **Avoid dangerous environments.** Do not operate this machine in wet or open flame environments. Airborne dust particles could cause an explosion and severe fire hazard.
6. **Ensure all guards are securely in place and in working condition.**
7. **Make sure switch is in the OFF position** before connecting power to machine.
8. **Keep work area clean, free of clutter, grease, etc.**
9. **Keep children and visitors away.** Visitors should be kept at a safe distance while operating unit.
10. **Childproof workshop with padlocks, master switches or by removing starter keys.**
11. **Disconnect machine when cleaning, adjusting or servicing.**

- 12. **Do not force tool.** The machine will do a safer and better job at the rate for which it was designed.
- 13. **Use correct tool.** Do not force machine or attachment to do a job for which it was not designed.
- 14. **Wear proper apparel.** Do not wear loose clothing, neck ties, gloves, jewelry, keep long hair tied up, etc.
- 15. **Remove adjusting keys and wrenches.** Before turning the machine on, make it a habit to check that all adjusting keys and wrenches have been removed.

16. **Use proper extension cord.** Examine the extension cord to ensure it is in good condition. Use TABLE 1 to determine the correct length and gauge of extension cord needed for your particular needs. The amp rating of the motor can be found on its nameplate. If the motor is dual voltage, be sure to use the amp rating for the voltage you will be using. If you use an extension cord with an under-sized gauge or one that is too long, excessive heat will be generated within the circuit increasing the chance of a fire or damage to the circuit. Always use an extension cord that uses a ground pin and connected ground wire. Immediately replace a damaged extension cord.

**Extension Cord Requirements**

TABLE 1

Amp Rating	Length and Gauge		
	25ft	50ft	100ft
0-6	#18	#16	#16
7-10	#18	#16	#14
11-12	#16	#16	#14
13-16	#14	#12	#12
17-20	#12	#12	#10
21-30	#10	#10	No

- 17. **Keep proper footing and balance** at all times.
- 18. **Do not leave machine unattended.** Wait until it comes to a complete stop before leaving the area.
- 19. **Perform machine maintenance and care.** Follow lubrication and accessory attachment instructions in the manual.

20. **Keep machine away from open flame.** Operating machines near pilot lights and/or open flames creates a high risk if dust is dispersed in the area. Dust particles and an ignition source may cause an explosion. Do not operate the machine in high-risk areas, including but not limited to, those mentioned above.

21. **If at any time you are experiencing difficulties** performing the intended operation, stop using the machine! Then contact our service department or ask a qualified expert how the operation should be performed.

22. **Habits—good and bad—are hard to break.** Develop good habits in your shop and safety will become second-nature to you.

**⚠ WARNING**

Always wear safety glasses or goggles when operating equipment. Operating this equipment creates the potential for flying debris that can cause eye injury. Everyday glasses or reading glasses only have impact resistant lenses, they are not safety glasses. Be certain the safety glasses you wear meet the appropriate standards of the American National Standards Institute (ANSI).

# Additional Safety Instructions for Edge Sanders

	<p><b>⚠️ WARNING</b></p> <p>Read and understand this entire instruction manual before using this machine. Serious personal injury may occur if safety and operational information is not understood and followed. Do not risk your safety by not reading!</p>
---	---

<p><b>⚠️ CAUTION</b></p>	<p>Use this and other machinery with caution and respect, and always consider safety first, as it applies to your individual working conditions. Remember, no list of safety guidelines can be complete and every shop environment is different. Failure to follow guidelines can result in serious personal injury, damage to equipment and/or poor work results.</p>
--------------------------	--

1. **Be aware of sanding belt rotation when sanding.** Always brace workpiece against the rotation of the sanding spindle.
2. **Keep fingertips away from the moving sanding belt.**
3. **Never use excessive force when sanding.** Doing this greatly increases the chances of personal injury and motor overload.
4. **Always feed the work against the direction of rotation.**
5. **Even if you have a reliable method of dust collection,** use a dust mask or respirator when sanding, as well as eye and ear protection.
6. **If there is any doubt as to the stability or integrity of the material to be sanded,** do not sand it.
7. **Do not operate sander with a damaged or badly worn sanding belt or rollers.**
8. **Sanding dust from some woods may be toxic or cause an allergic reaction.** Be sure to wear an appropriate respirator when working around sawdust. Make sure there is adequate ventilation or a constant source of fresh air. The sawdust from some species of wood can be toxic to some people. Be sure to research the dangers of the specific species of wood you are working with.



# Avoiding Potential Injuries

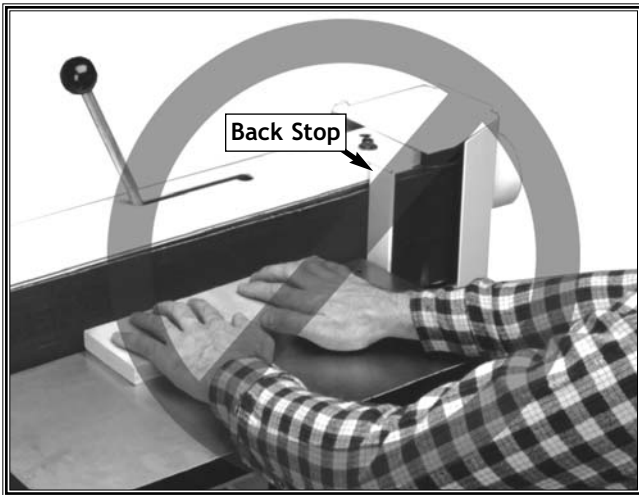

**Figure 1.** DO NOT hold wood away from the back stop, and keep your fingers away from the belt.

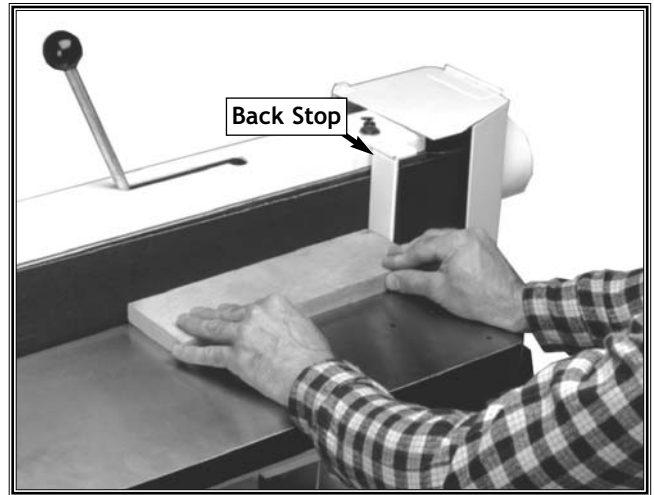

**Figure 2.** ALWAYS use the back stop, and keep your fingers away from the belt.



**Figure 3.** DO NOT sand wood with your fingers close to the idler roller and belt.



**Figure 4.** ALWAYS keep your fingers away from the idler roller and the belt.



**Figure 5.** DO NOT sand wood with sharp corners at the leading-edge of the sanding operation. The belt can grab and throw the wood.



**Figure 6.** ALWAYS sand wood with sharp corners at the trailing-edge of the sanding operation.

# ELECTRICAL REQUIREMENTS

## 220V Operation

The SHOP FOX® W1688 is prewired for 220V operation. You will need a NEMA-style 6-15 plug and receptacle as shown in **Figure 7**. The motor supplied with your new machine is rated at 1½ HP and draws approximately 8 amps during 220 volt operation. Use an outlet with a 10 amp circuit breaker or fuse. Remember other machines using the same circuit as this machine add to the total electrical load applied to the circuit. If this total amperage load exceeds the amperage rating of the circuit breaker or fuse, use a different circuit with a higher amperage rating.

DO NOT modify an existing low-amperage circuit by only replacing the circuit breaker with a breaker rated for a higher amperage. The breaker and the complete circuit must be replaced by a qualified electrician.

## Extension Cords

We do not recommend using an extension cord with 220V equipment. Using extension cords with an undersized gauge or one that is too long, generates heat in the cord that may cause fire or circuit damage. If you must use an extension cord, use the guidelines below and **TABLE 2** to determine the correct cord length and gauge. The amp rating of the motor is 8 amps while wired for 220V and can be found on the motor-data plate.

- Use a cord rated for Hard Service (Grade S)
- Use a cord that is 100 feet or less only
- Use a cord with a NEMA-style 6-15 plug
- Use an undamaged cord only

**Extension Cord Requirements**  
TABLE 2

Amp Rating	Length and Gauge		
	25ft	50ft	100ft
7-10	#18	#16	#14
11-12	#16	#16	#14
13-16	#14	#12	#12
17-20	#12	#12	#10
21-30	#10	#10	No

## Grounding

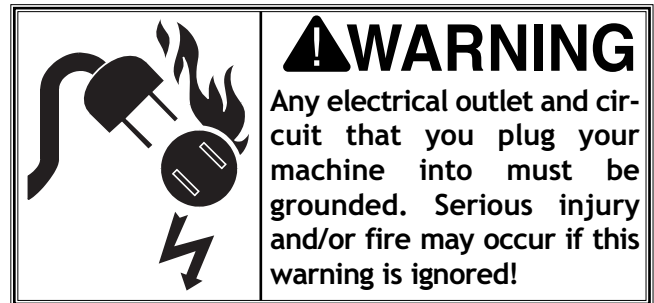

Ground this machine! The electrical cord supplied with the Model W1688 does not come with a 220 volt plug. Use a plug with a ground pin as shown in **Figure 7**. If your receptacle does not accommodate a NEMA 6-15 plug with a ground pin, have the receptacle replaced by a qualified electrician or have an appropriate adapter installed and grounded properly.



Remember, an adapter with a grounding wire does not guarantee the machine will be grounded. A ground source must always be verified in the electrical circuit within the wall or conduit.

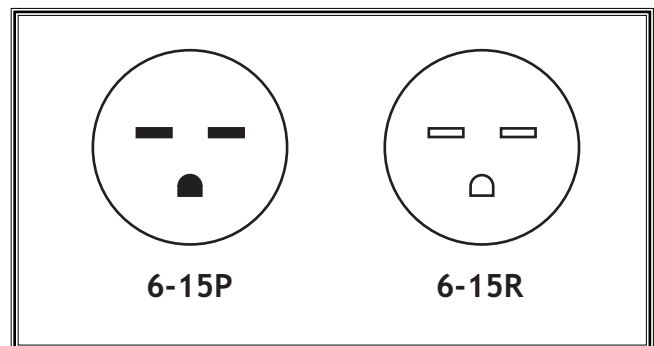

**Figure 7.** NEMA-style 6-15 plug and receptacle.

# 110V Operation

The SHOP FOX® W1688 can also be operated at 110 volts (refer to the wiring diagram on Page 38). You will need a NEMA-style 5-20 plug and receptacle as shown in Figure 8. The motor is rated at 1½ HP and draws approximately 16 amps. Use an outlet with a 20 amp circuit breaker or fuse. Remember other machines using the same circuit as this machine add to the total electrical load applied to the circuit. Add up the amperage load ratings of all machines on the circuit. If this total amperage load exceeds the amperage rating of the circuit breaker or fuse, use a different circuit with a higher amperage rating.

DO NOT modify an existing low-amperage circuit by only replacing the circuit breaker with a breaker rated for a higher amperage. The breaker and the complete circuit must be replaced by a qualified electrician.

## Extension Cords

We do not recommend using an extension cord with 110V equipment. Using extension cords with an undersized gauge or one that is too long, generates heat in the cord that may cause fire or circuit damage. If you must use an extension cord, use the guidelines below and TABLE 3 to determine the correct cord length and gauge. The amp rating of the motor is 16 amps while wired for 110V and can be found on the motor-data plate.

- Use a cord rated for Hard Service (Grade S)
- Use a cord that is 100 feet or less only
- Use a cord with a NEMA-style 5-20 plug
- Use only undamaged cords

### Extension Cord Requirements

TABLE 3

Amp Rating	Length and Gauge		
	25ft	50ft	100ft
17-20	#12	#12	#10
21-30	#10	#10	No

# Grounding



**⚠ WARNING**

Any electrical outlet and circuit that you plug your machine into must be grounded. Serious injury and/or fire may occur if this warning is ignored!

Ground this machine! The electrical cord supplied with the Model W1688 does not come with a 110 volt plug. Use a plug with a ground pin as shown in Figure 8. If your receptacle does not accommodate a NEMA 5-20 plug with a ground pin, have the receptacle replaced by a qualified electrician or have an appropriate adapter installed and grounded properly.

**NOTICE**

Make sure when using an adapter, the adapter is grounded.

Remember, an adapter with a grounding wire does not guarantee the machine will be grounded. A ground source must always be verified in the electrical circuit within the wall or conduit.

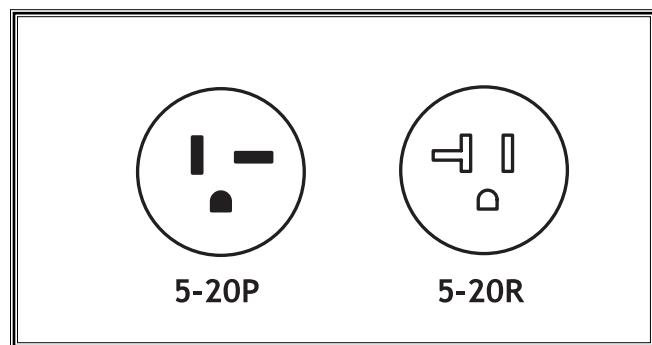

Figure 8. Typical NEMA 5-20 plug and receptacle.

ELECTRICAL

This Page Intentionally Left Blank

# ASSEMBLY

## Unpacking

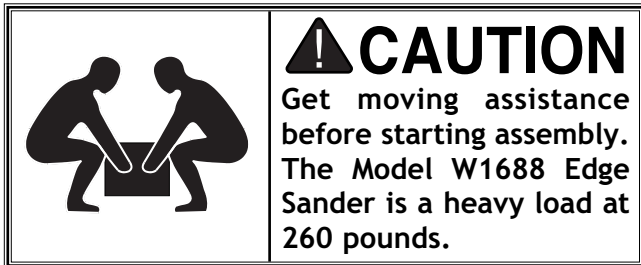

The Model W1688 Edge Sander is carefully packed. However, if it is damaged or is missing any parts, please contact Woodstock International Service and Support at 1-360-734-3482 or send e-mail to: [tech-support@shopfox.biz](mailto:tech-support@shopfox.biz).



Figure 9. W1688 Edge Sander

## Box Contents

Layout and inventory the shipped parts to familiarize yourself with your edge sander. See Figures 9 and 10. This will help with machine assembly.

Item	Qty.
1. W1688 Edge Sander	1
2. Auxiliary Table	1
3. Auxiliary Table Lock Knob	1
4. Main Table	1
5. Hex Bolt ( $\frac{5}{16}$ "-18 X 1")	2
6. Flat Washer ( $\frac{5}{16}$ "	2
7. Miter Gauge	1
8. Miter Lock Knob	1
9. Back Stop	1
10. Cap Screw ( $\frac{3}{8}$ "-16 X 1")	1
11. Flat Washer ( $\frac{3}{8}$ "	1
12. Quick Release Lever	1
13. Jam Nut ( $\frac{1}{2}$ " X 13)	1
14. Abrasive Belt (6" X 80")	1
15. Rubber Foot	4
16. Hex Bolt ( $\frac{5}{16}$ "-18 X $\frac{1}{2}$ "	4
17. Hex Nut ( $\frac{5}{16}$ "	8

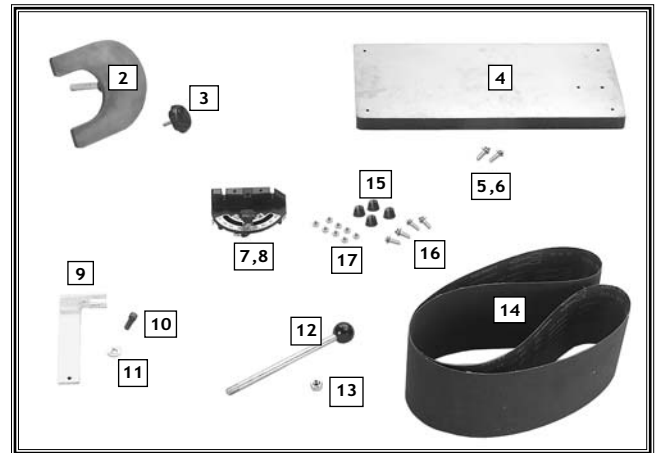

Figure 10. Components

# Shop Preparation

	<p><b>⚠ CAUTION</b>          Make sure all shop entrances are locked and machines are equipped with safety lock-out devices when not in use. Never allow untrained people in your shop! Otherwise, injury or death can occur.</p>
---	---

- **Edge Sander Location:** Choose a location where if a workpiece should be projected, bystanders will not be struck. Take all necessary safety precautions.
- **Working Clearances:** Consider your current and future needs with respect to size of lumber to be processed at each machine, space for auxiliary stands, work tables, and other machinery.
- **Lighting:** Make sure your lighting eliminates shadows and prevents eye strain.
- **Outlets:** Make sure electrical circuits are dedicated or large enough to handle the amperage requirements of the new machinery. Electrical outlets should be located near each machine so power or extension cords are clear of high-traffic areas.

# Beginning

The main components of the Model W1688 are assembled at the factory; however, some assembly is required. The following series of instructions are the recommended sequence for final assembly.

	<p><b>⚠ WARNING</b>          Keep your machine unplugged during all assembly, adjustments, or maintenance procedures. Otherwise serious personal injury may occur!</p>
---	--



# Cleaning

The Model W1688 table and other unpainted parts are coated with a waxy grease for corrosion protection. For the best machine performance, clean all moving parts and coated surfaces. Remove this grease with a solvent cleaner or a citrus-based degreaser. Do not use chlorine-based solvents—if you splash these solvents onto a painted surface, you will ruin painted and plastic finishes.

Before cleaning the machine, read and understand the following Warnings and Caution:

	<p><b>⚠ WARNING</b>          Never use flammables such as gas or other petroleum-based solvents to clean your machine. These products have low flash points and present the risk of explosion and severe personal injury!</p>
--	---

	<p><b>⚠ WARNING</b>          Never smoke while using cleaning solvents. Smoking may cause explosion or risk of fire when exposed to these products!</p>
--	---

	<p><b>⚠ CAUTION</b>          Most solvents used to clean machinery are toxic when inhaled or ingested. When using these products, work in a well ventilated area and keep away from any potential ignition sources (pilot lights). Always dispose of any waste rags in a sealed container to make sure they do not cause fire or environmental hazards.</p>
	
	

ASSEMBLY

# Feet

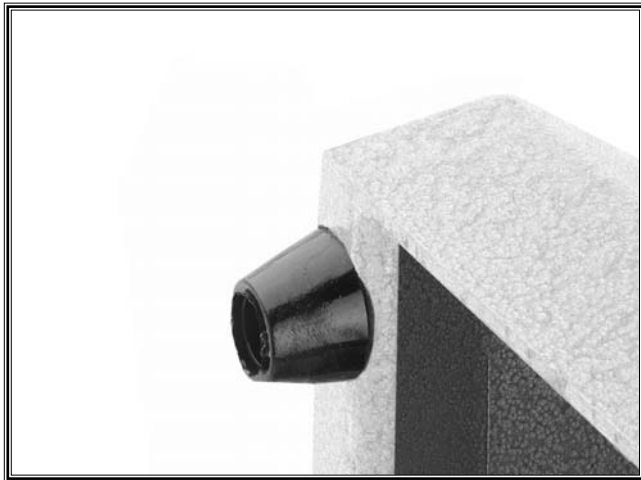

Figure 11. One rubber foot installed.

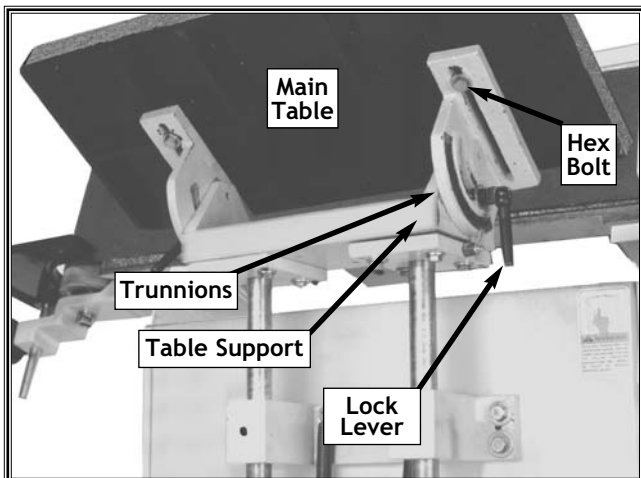

Figure 12. Main table and trunnions mounted on the table support bracket.

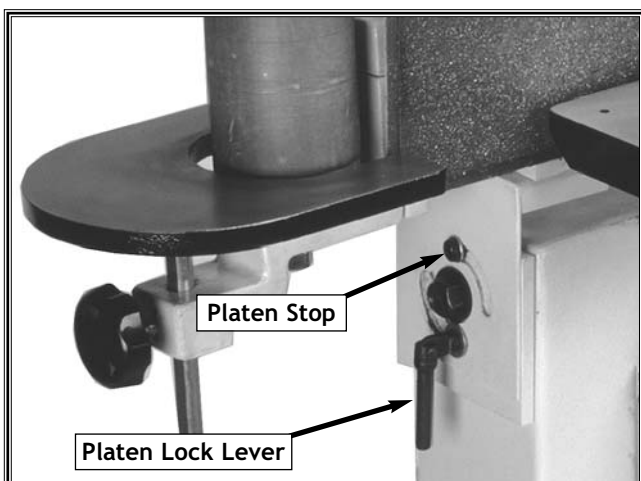

Figure 13. Tilt the platen so it is at 0° degrees vertical and the platen has bottomed against the stop.

The rubber feet are designed to minimize vibration and reduce wear-and-tear on the machine.

	<p><b>⚠ WARNING</b> Wear safety glasses during assembly. Serious injury may occur if this warning is ignored!</p>
--	---

	<p><b>⚠ CAUTION</b> Get moving assistance before starting assembly. The Model W1688 Edge Sander is a heavy load at 260 pounds.</p>
--	--

To install the feet, do these steps:

1. Carefully lay the machine on its side.
2. Install the 4 feet using the supplied  $\frac{5}{16}$ "-18 x  $\frac{1}{2}$ " bolts and the  $\frac{1}{4}$ " nuts. See Figure 11.
3. Carefully upright the machine and use the bolts and nuts to adjust the feet height so the machine is stable.

# Main Table

The main table is used to support the wood during vertical sanding operations and mounts the miter body.

To install the main table, do these steps:

1. Position the main table on the trunnions and install two  $\frac{5}{16}$ "-18 X 1" hex bolts and the  $\frac{5}{16}$ " flat washers, but do not tighten yet. See Figure 12.
2. Tilt the platen so it is at 0° degrees vertical and the platen has bottomed against the stop. See Figure 13.
3. Tighten the platen lock lever. See Figure 13.

- With one hand, hold the main table and with the other hand place a machinist's square on the main table and against the platen graphite pad. See Figure 14.

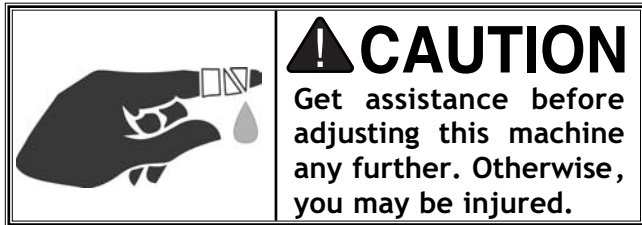

- Have an assistant loosen both of the main-table tilt levers, and tilt the main-table so the table is perpendicular to the platen as indicated by the machinist's square. See Figure 14.
- Tighten both main-table tilt lock levers. See Figure 15.
- Loosen the pointer screw and set the pointer to zero. See Figure 15.
- Retighten the pointer screw and make sure the pointer is still pointing to zero.

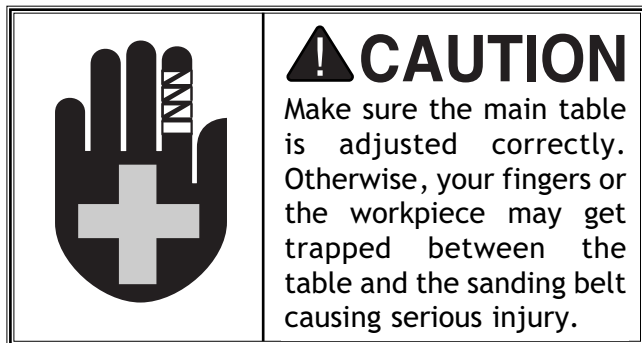

- Slide the main table toward the platen so the table-to-platen gap is no more than  $\frac{1}{4}$ " at both ends of the platen. See Figure 16.
- Tighten the two trunnion  $\frac{5}{16}$ "-18 X 1" hex bolts. See Figure 15.

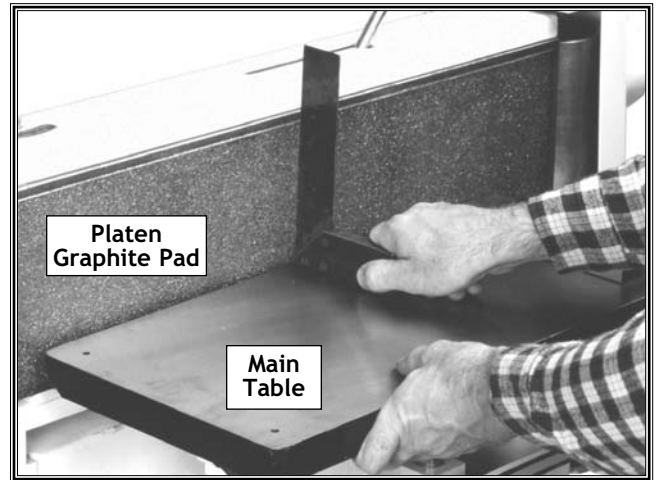

Figure 14. Machinist's square on the main table and against the platen graphite pad.

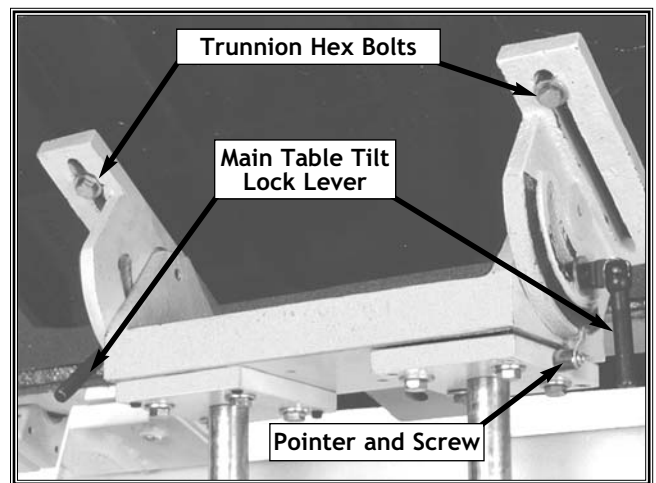

Figure 15. Main table-tilt lock levers and scale.

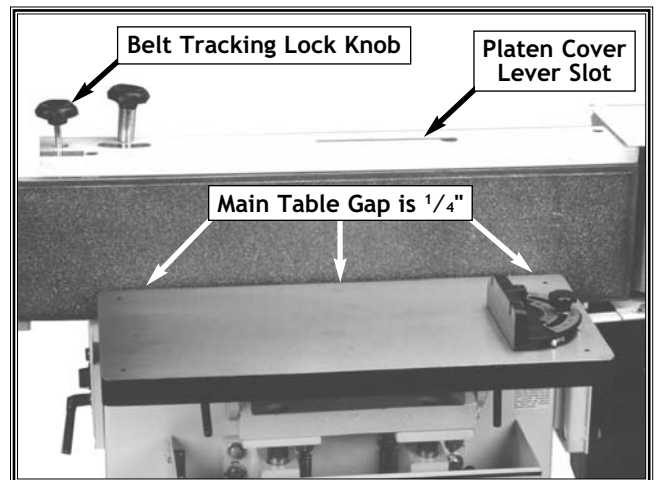

Figure 16. Main table gap.

ASSEMBLY



## Quick Release Lever

Your Model W1688 Edge Sander is equipped with the quick release lever that allows you to release the tension on the belt for quick belt changing.

To install the quick release lever, do these steps:

1. Loosen the belt tracking lock knob. See **Figure 16**.
2. Slide the quick release lever through the platen cover lever slot. See **Figure 16**.
3. Thread the 1/2" jam nut onto the quick release lever until the nut bottoms at the end of the lever threads and thread the lever into the swivel assembly until the lever bottoms. If required have an assistant push the idler roller inward to line up the swivel assembly with the threaded lever. See **Figure 17**.
4. Tighten the jam nut and the belt tracking lock knob. See **Figure 17**.

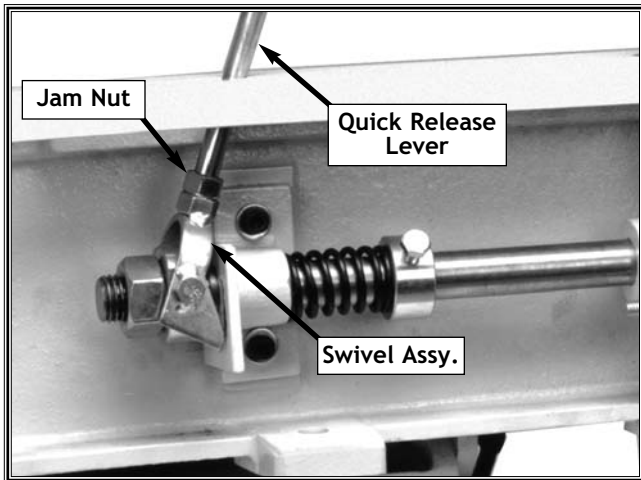

**Figure 17.** Quick release lever, jam nut, and swivel assy.

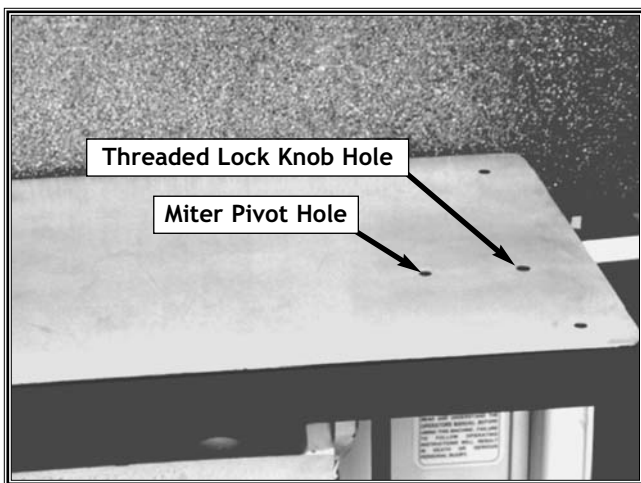

**Figure 18.** miter gauge holes in main table.

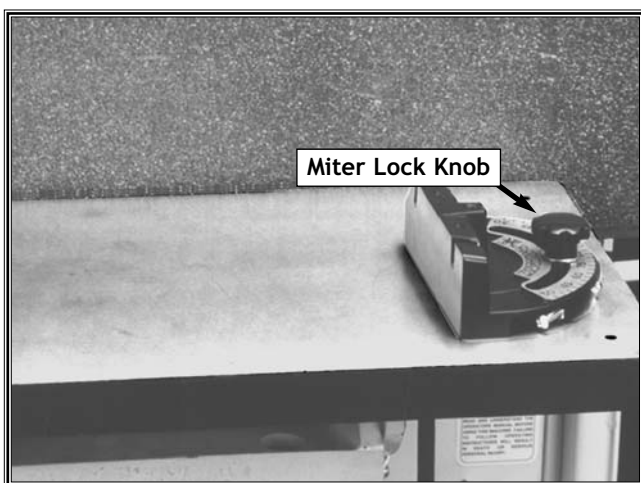

**Figure 19.** Miter gauge installed.

## Miter Gauge

The miter gauge is used when sanding the ends of workpieces at least 8" long at various angles. The miter gauge is not a back stop!

To install the miter gauge, do these steps:

1. Locate the miter gauge pivot hole and the threaded lock-knob hole in the main table. See **Figure 18**.

### NOTICE

The miter gauge pivot pin pivots from one main table location only. Any other hole in the table is not used for the miter gauge.

2. Insert the miter gauge pivot pin located at the underside of the miter gauge into the pivot hole located at the top of the main table.
3. Secure the miter gauge to the table using the miter lock knob as shown in **Figure 19**.

# Dust Hood

When connected to a dust collection system, the dust hood directs suction to remove harmful wood and abrasive dust from your work area. For additional information on the correct dust collection system, additions, or modifications; contact your Woodstock International dealer for your copy of the *Dust Collection Basics* handbook and available accessories.

	<p><b>⚠ CAUTION</b></p> <p>DO NOT operate this machine without the correct dust collection system. Failure to use a dust collection system can result in short and long-term respiratory illness.</p>
---	---

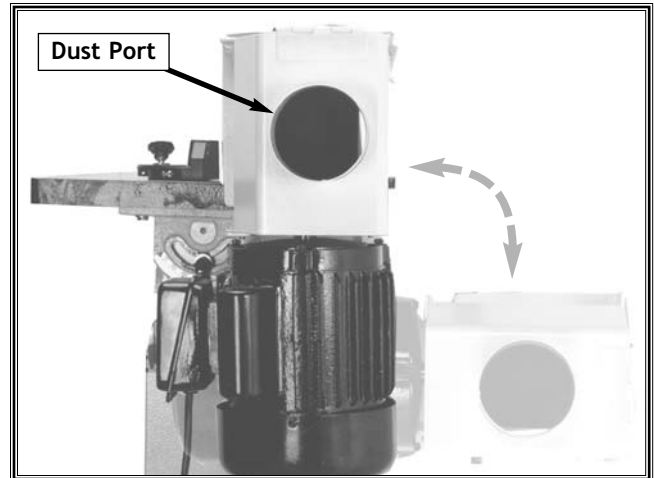

Figure 20. Platen and dust hood tilt.

To connect dust hood, do these steps:

1. Locate your dust edge sander where it will be used
2. Connect your dust collection suction tube to the dust port, so when you tilt the platen from the vertical to the horizontal position, the suction tube will not bind, leak, or disconnect the dust-collector ducting ground. See Figure 20.

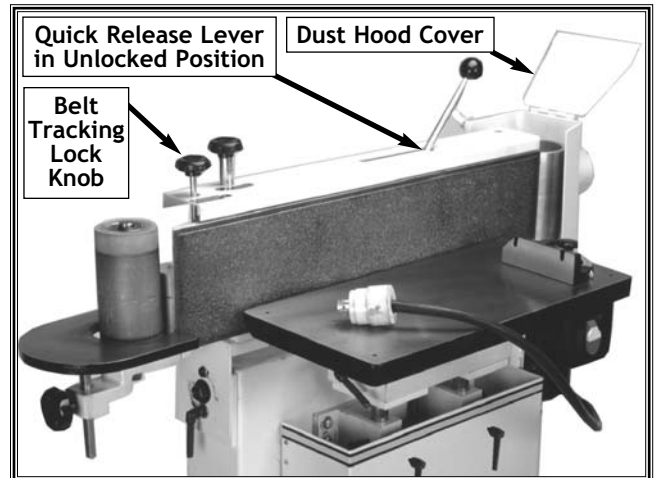

Figure 21. Belt tracking lock knob, dust port cover, and quick release lever.

# Sanding Belt

Your Model W1688 Edge Sander is shipped with a general purpose sanding belt great for most woodworking needs. With proper care, machine operation, and dressing the belt with the use of a PRO-STIK® belt cleaner available through your Woodstock International dealer, your edge sander belt will enjoy extended service life.

To install the sanding belt, do these steps:

1. Loosen the belt tracking lock knob. See Figure 21.
2. Unlatch and open the dust port cover. See Figure 21.



Figure 22. Sanding belt directional installation.

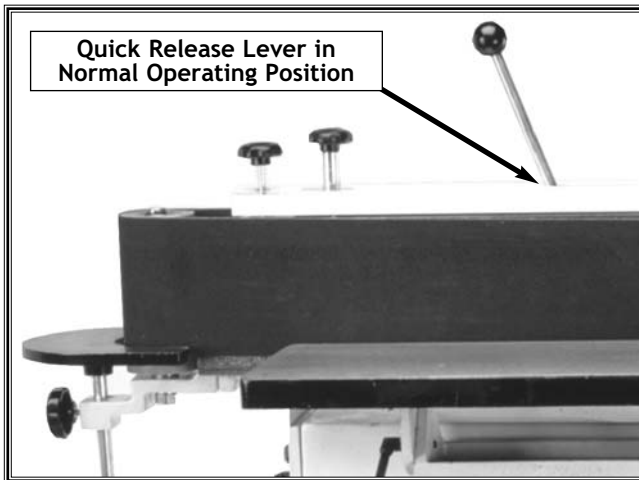

Figure 23. Sanding-belt quick release lever in the normal operating position.

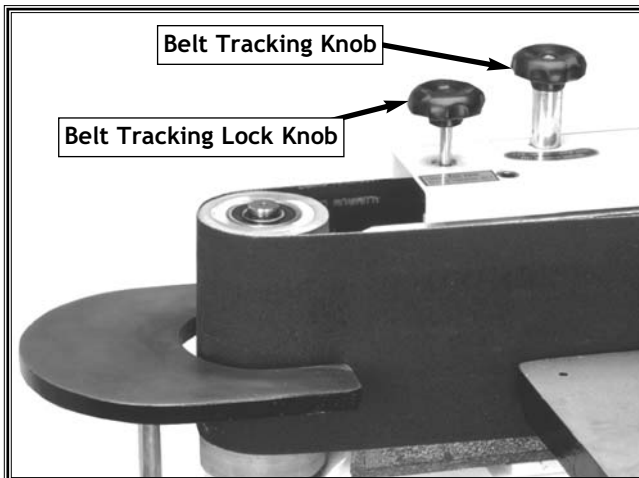

Figure 24. Belt-tracking lock knob.

3. Move the quick release lever to the unlocked position so it drops into the lock groove. See Figure 23.
4. Locate the arrows printed on the inside of the sanding belt that indicate direction or belt rotation. See Figure 22.
5. Slide the sanding belt over the pulleys so that the belt rotation (shown with arrows on the inside of belt) matches the counter-clockwise rotation of the sander pulleys. See Figure 22.

	<p><b>!WARNING</b></p> <p>Keep your machine unplugged during all assembly, adjustments, or maintenance procedures. Otherwise serious personal injury may occur!</p>
--	---

6. Position the belt so it is centered on the platen and pulleys and is in the normal operating position. See Figure 23.
7. Close and latch shut the dust port cover.
8. Move the quick release lever out of the lock groove so the idler pulley applies tension to the sanding belt, and the quick release lever rests in the normal operating position. See Figure 23.
9. With the sander unplugged, carefully use your hand to rotate the sanding belt a few rotations in the operating direction to make sure the belt stays in the normal operation position.
  - If the belt tracks to high or to low, go to **Page 19** and adjust the vertical belt tracking so the belt tracks in the center.
  - If the belt tracks diagonally, go to **Page 20** and adjust the diagonal belt tracking so the belt tracks horizontally.
10. Tighten the belt tracking lock knob if the belt tracks correctly. See Figure 24.

# Back Stop

The back stop is used to support shorter workpieces and for 90° horizontal platen sanding operations. See Figure 25.

	<p><b>CAUTION</b></p> <p>Make sure the back stop is adjusted correctly. Otherwise, your fingers or the workpiece may get trapped between the back stop and the sanding belt causing serious injury.</p>
--	---

To install the back stop, do these steps:

1. Position the back stop and install the cap screw and washer finger tight. See Figure 26.
2. Position the back stop no closer or no farther than  $\frac{1}{8}$ " to the surface of the sanding belt. See Figure 26.
3. Tighten the Allen® bolt.

## Auxiliary Table

The auxiliary table is used to assist you when sanding curves with the idler roller when the the platen cannot be used.

To install the auxiliary table, do these steps:

1. Slide the auxiliary table into the mounting bracket. See Figure 27.
2. Position the auxiliary table so it is at the center position and it is not touching the idler roller and sanding belt. See Figure 27.
3. Secure the auxiliary table by installing and tightening the lock knob into position.

## NOTICE

The auxiliary table does NOT need to be installed on the sander at all times. However, by leaving it installed, it provides additional protection against contact with the idler roller and belt.

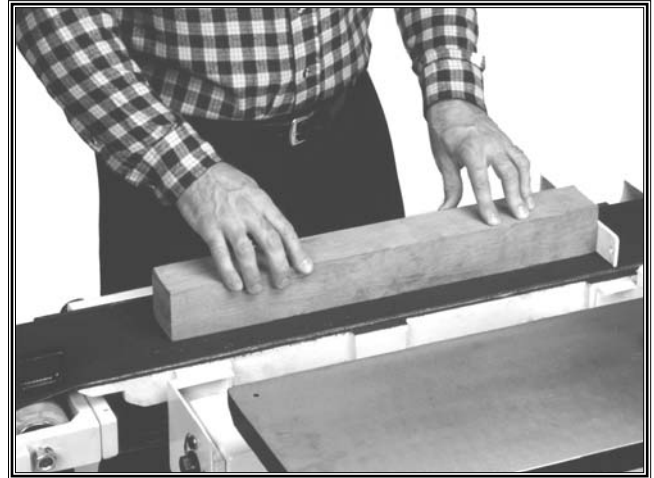

Figure 25. Back stop use in horizontal sanding operations.

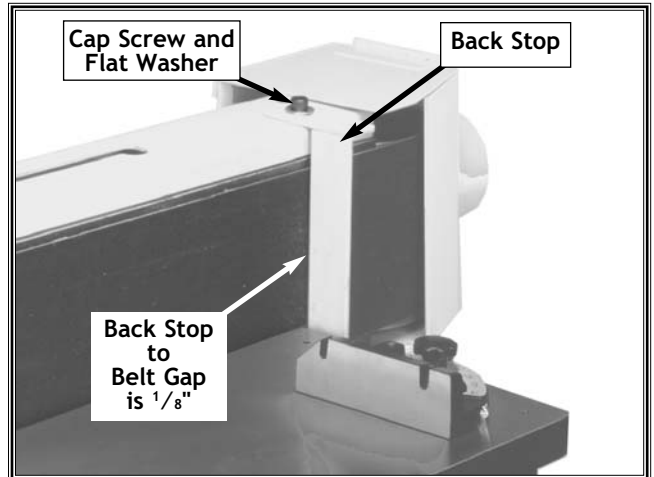

Figure 26. The back stop gap.

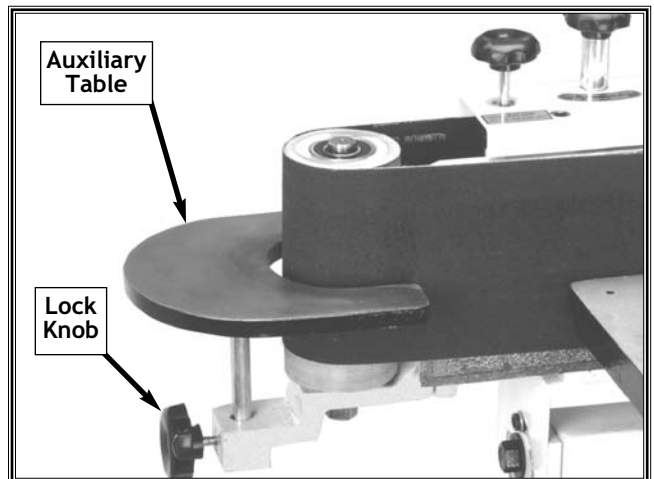

Figure 27. Auxiliary table installed.

ASSEMBLY

# ADJUSTMENTS

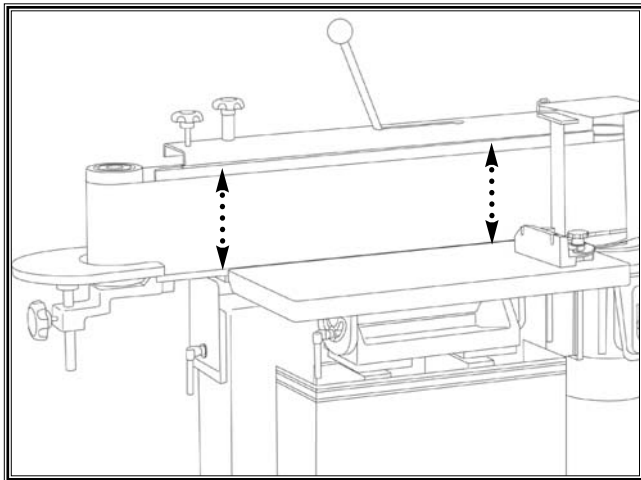

Figure 28. Vertical belt tracking adjustment.

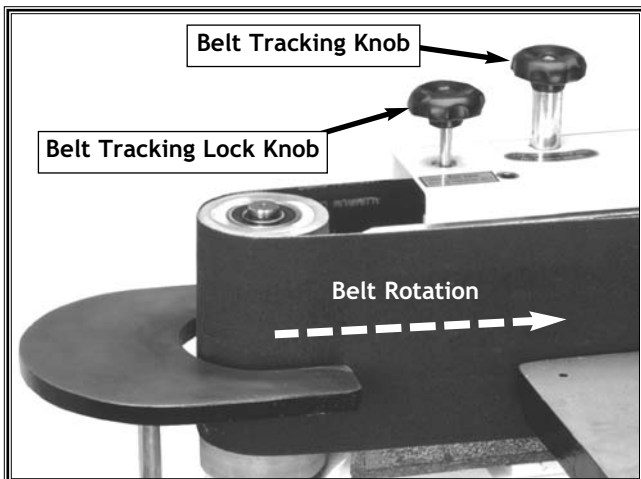

Figure 29. Belt tracking lock knob and belt tracking knob.

## Vertical Belt Tracking

Through normal operation, sanding belts become worn on the inside and outside surfaces, which can cause the belt to track too high or too low on the platen and pulleys. See Figure 28. You can compensate for this normal wear by adjusting the belt tracking knobs.

	<p><b>!WARNING</b></p> <p>Keep your machine unplugged during all assembly, adjustments, or maintenance procedures. Otherwise serious personal injury may occur!</p>
--	---

To adjust the vertical belt tracking, do these steps:

1. Unplug the edge sander.
2. Loosen the belt tracking lock knob. See Figure 29.
3. With the sander unplugged, turn the belt tracking knob in either direction while you rotate the sanding belt. See Figure 29. The belt will track higher or lower depending on which direction you turn the belt tracking knob.
4. When the belt tracks in the center of the platen, tighten the belt tracking lock knob.
5. Rotate the belt a few more times to make sure the belt stays in the normal operating position. If it does not, repeat steps 1 through 5.

# Diagonal Belt Tracking

The diagonal belt tracking for your Model W1688 Edge Sander has been setup at the factory; however, due to shipping or long use of the sander, the belt can begin to track diagonally. You can compensate for this normal condition by adjusting the roller support bracket. See Figure 30.

	<p><b>⚠ WARNING</b>          Keep your machine unplugged during all assembly, adjustments, or maintenance procedures. Otherwise serious personal injury may occur!</p>
--	--

To adjust the diagonal belt tracking, do these steps:

1. Unplug the edge sander.
2. Loosen the belt tracking lock knob. See Figure 31.
3. With the sander unplugged, loosen the two  $\frac{3}{8}$ "-16 X  $1\frac{1}{2}$ " cap screws. See Figure 32.
4. While you rotate the sanding belt in the counterclockwise operating direction, alternately adjust the four Allen® set screws to tilt the idler roller and roller support bracket inward or outward in very small increments. See Figure 32. By tilting the idler roller this way, the belt will track horizontally.
5. When the belt tracking is not diagonal and is horizontal, tighten the the two cap screws. See Figure 32.
6. Tighten the belt tracking lock knob.
7. Rotate the belt a few more times to make sure the belt stays in the normal operating position. If it does not, repeat steps 1 through 7.

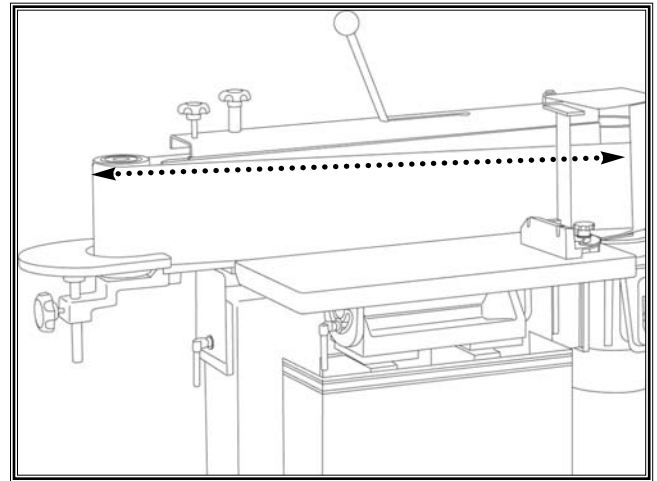

Figure 30. Diagonal belt tracking.

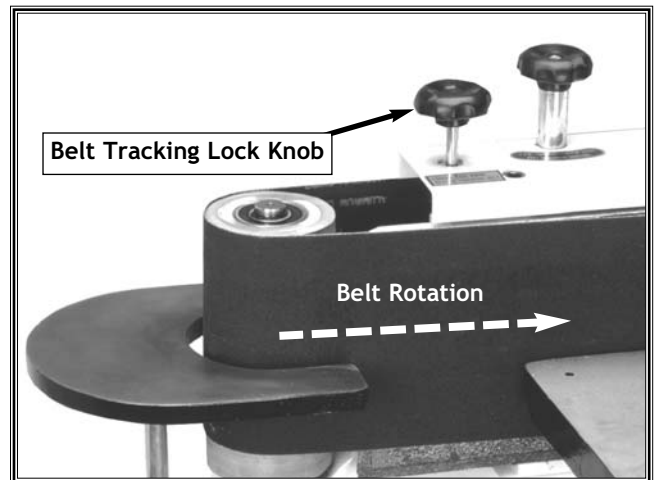

Figure 31. Belt tracking lock knob and belt tracking knob.

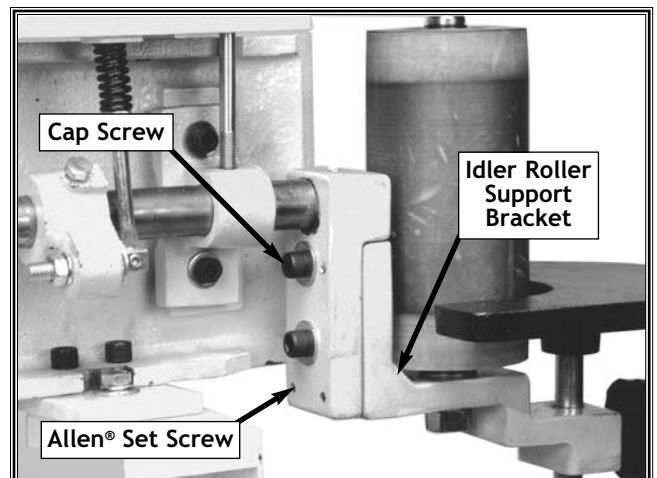

Figure 32. Roller block bracket and Allen® set screws.

# Platen-to-Roller Alignment

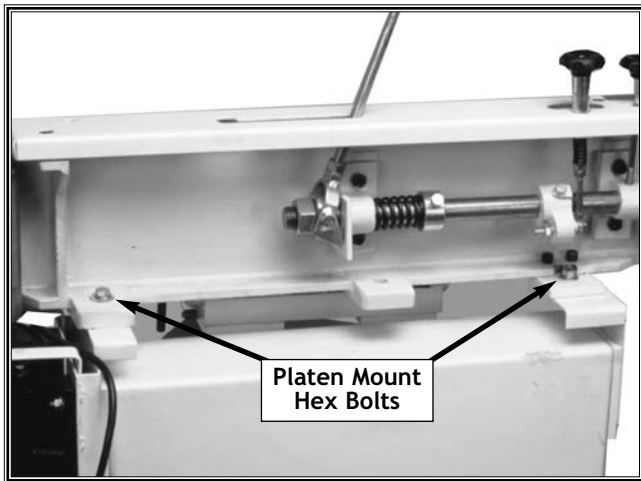

Figure 33. Platen and retaining bolts.

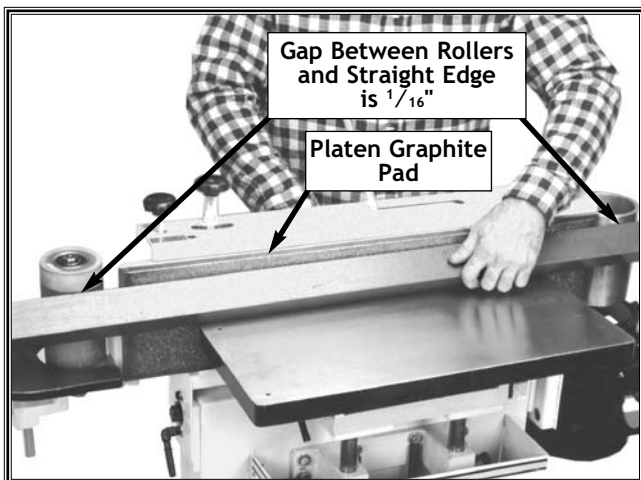

Figure 34. Straight edge across the rollers and touching the platen graphite pad.

The platen-to-roller alignment for your Model W1688 Edge Sander has been setup at the factory; however, due to shipping or long use of the sander, the platen-to-roller alignment can change. You can compensate for this normal condition by adjusting the platen toward a straight edge set across the rollers.

	<p><b>WARNING</b></p> <p>Keep your machine unplugged during all assembly, adjustments, or maintenance procedures. Otherwise serious personal injury may occur!</p>
--	--

To adjust the platen-to-roller alignment, do these steps:

1. Unplug the edge sander.
2. Remove the sanding belt as outlined on Page 16.
3. With the sander unplugged, loosen the two  $\frac{3}{8}$ "-16 X 1" hex bolts. See Figure 33.

<p style="text-align: center;"><b>NOTICE</b></p> <p>DO NOT adjust the platen so the platen graphite pad is more than <math>\frac{1}{16}</math>" past the rollers. Otherwise, the belt and graphite pad can make excessive heat and wear prematurely.</p>
--

4. Set a straightedge across the rollers and slide the platen toward the straightedge so the platen graphite pad is against the straightedge at both ends. See Figure 34.
5. Slide the platen outward until there is a gap of  $\frac{1}{16}$ " between the rollers and the straightedge. See Figure 34.
6. Tighten the two  $\frac{3}{8}$ "-16 X 1" hex bolts.
7. Install the sanding belt as outlined on Page 16.

# Belt Tension

The sanding belt tension for your Model W1688 Edge Sander has been setup at the factory; however, due to shipping, varying belt length, or long use of the sander, the tension may need to be adjusted. You can compensate for this normal condition by adjusting the hex bolt on the end of the tension rod to increase or decrease the belt tension. See Figure 35.

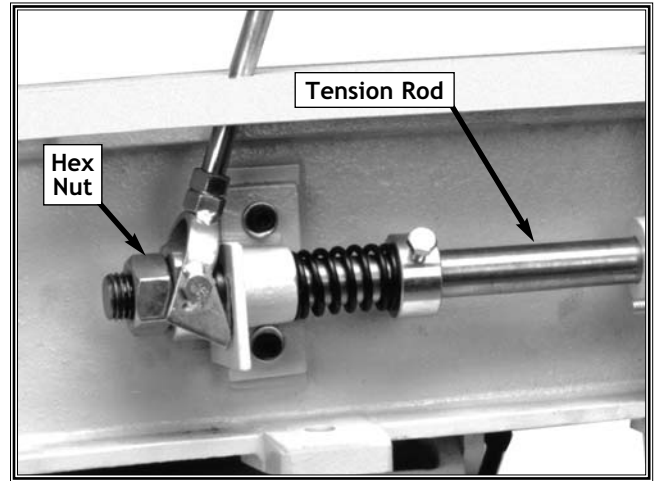

Figure 35. Hex nut and belt tension rod.

	<p><b>⚠ WARNING</b>          Keep your machine unplugged during all assembly, adjustments, or maintenance procedures. Otherwise serious personal injury may occur!</p>
--	--

To adjust the belt tension, do these steps:

1. Unplug the edge sander.

<p><b>⚠ WARNING</b></p>
<p>DO NOT unthread the nut to expose the internal threads of the nut. The nut may rattle off as a result, and jam the machine causing machine damage and personal injury!</p>

2. Turn the 1"-8 hex nut on the end of the tension rod counterclockwise to increase the belt tension, or turn it clockwise to decrease the belt tension. See Figure 35. The tension must hold the belt firmly without belt slap on the platen or skidding on the rollers during sanding operations.

ADJUSTMENTS



## Main Table Height



**Figure 36.** Hold the main table and loosen the lock lever.

Periodically through normal operation of the Model 1688 Edge Sander, the belts will wear in certain areas. To compensate for this wear and ensure consistent sanding or to adjust for a workpiece, you can adjust the main table higher or lower. The table is fitted with springs to make the adjustment quick and easy.

**To adjust the table height, do these steps:**

1. With one hand, hold the main table, and with the other hand loosen the main table lock levers. See **Figure 36**.
3. Raise or lower the main table to the desired height, and tighten the main table lock levers.

# Main Table Tilt

Often you may have to tilt the main table to accommodate for the angles of your workpiece. The main table is equipped with a degree scale which indicates the angle that the the workpiece will be sanded at.

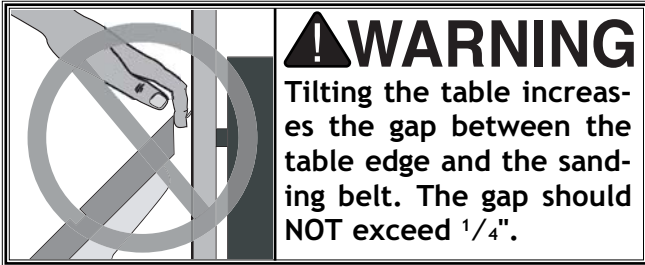

**!WARNING**  
Tilting the table increases the gap between the table edge and the sanding belt. The gap should NOT exceed 1/4".



**!WARNING**  
DO NOT loosen both table height lock levers at the same time without holding the main table in position. The table can quickly tilt and cause injury. See Figure 37.

To adjust the main table angle, do these steps:

1. With one hand, hold the main table, and with the other hand loosen the main table tilt lock levers. See Figure 38.
2. Tilt the main table to the desired angle using the angle scale. See Figure 39.
3. Tighten the main table tilt lock levers.

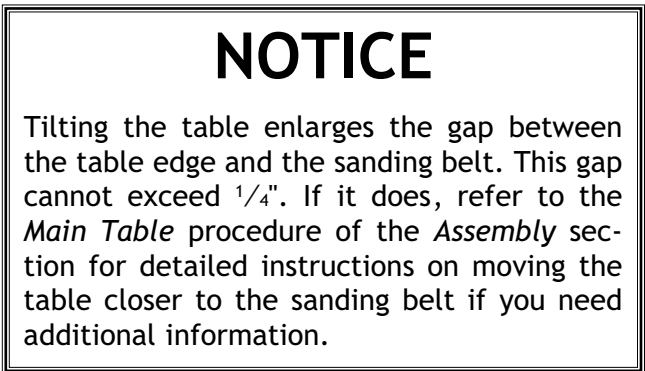

**NOTICE**  
Tilting the table enlarges the gap between the table edge and the sanding belt. This gap cannot exceed 1/4". If it does, refer to the *Main Table* procedure of the *Assembly* section for detailed instructions on moving the table closer to the sanding belt if you need additional information.

4. Loosen the two table-to-trunnion 5/16"-18 X 1" hex bolts.
5. Slide the main table toward the platen so the table-to-platen gap is no more than 1/4" at both ends of the platen.
6. Tighten the two table-to-trunnion hex bolts.

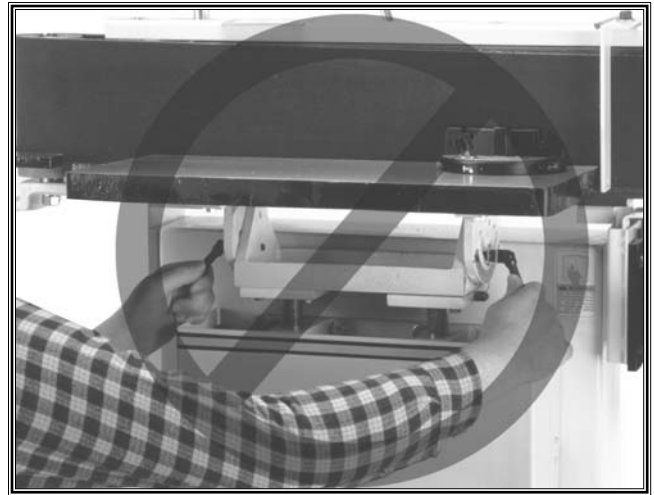

Figure 37. DO NOT loosen both table tilt lock levers at the same time.



Figure 38. Hold the main table and loosen the lock lever.

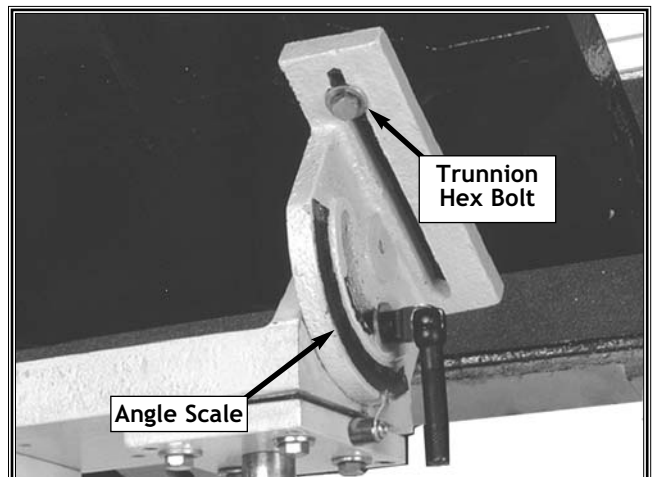

Figure 39. Use the angle scale to find your desired main table angle.

# OPERATIONS

## Starting the Sander

ALWAYS take a few moments to listen and observe for unusual noise and vibration after starting the edge sander.



Figure 40. ON/OFF switch in the ON position.



Figure 41. Ready for emergency shut down.



Figure 42. Safety lockout key removed.

	<p><b>! WARNING</b></p> <p>DO NOT start this sander until you have completed all assembly, adjustments, safety requirements, and you have read and understand this entire manual.</p>
--	---

	<p><b>! WARNING</b></p> <p>Always wear a dust mask and safety glasses when operating this machine. Sawdust may cause allergic reactions or respiratory problems.</p>
--	--

	<p><b>! WARNING</b></p> <p>Make sure loose clothing and long hair is secured and kept away from moving parts.</p>
--	---

To start the edge sander, do these steps:

1. Pull the ON/OFF switch up. See Figure 40.
2. Position your finger over the ON/OFF switch so you are ready to shut the sander OFF if there is a problem. See Figure 41.
3. Listen for any unusual noises. The sander must run smoothly with little or no vibration.
4. If unusual noise or vibration exists, shut the sander off immediately. DO NOT restart the sander until you correct the problem.
5. Remove the safety lockout key and unplug the sander, troubleshoot the source of the noise or vibration, and correct the problem. DO NOT make any adjustments to the sander while it is plugged in. See Figure 42.

# Platen Tilting

Often you will have to sand the face of a work-piece, which is one of the most common sanding operations. To help you accomplish this task, the Model W1688 Edge Sander has the option of either vertical or horizontal tilt.

## **⚠️ WARNING**

**DO NOT** tilt the platen by only holding the idler roller and the auxiliary table shaft. The platen is heavy and can fall and cause injury. See Figure 43.

To tilt the platen, do these steps:

1. Loosen the platen tilt lock lever and hold the quick release lever and the auxiliary table. See Figure 44.
2. Carefully tilt the platen to the horizontal position.
3. Make sure the platen tilt stop is at the bottom of the platen travel slot, which indicates the platen is in full-horizontal position. See Figure 44.

**DO NOT** use the platen tilt at any other angle. See Figure 45.

## **⚠️ WARNING**

Make sure you adjust the vertical belt tracking. **DO NOT** ignore this adjustment. Otherwise, the belt can immediately run off the sander when the sander is started and cause personal injury.

4. Adjust the vertical belt tracking as outlined on Page 19.



**Figure 43.** Incorrectly holding and tilting the platen.

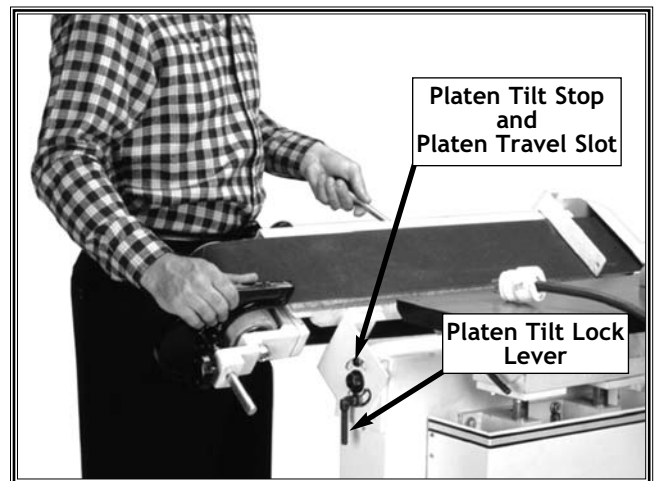

**Figure 44.** Correctly hold the quick release lever and auxiliary table to tilt the platen.



**Figure 45.** Incorrect platen tilted position.

# Vertical Sanding

The steps below show you how to sand the edges and the ends of a basic workpiece, which is one of the most common sanding operations you will do.



**Figure 46.** DO NOT hold wood away from the back stop, DO NOT place fingers near the belt.



**Figure 47.** ALWAYS use the back stop, and keep your fingers away from the belt.

	<p><b>!WARNING</b> Always wear a dust mask and safety glasses when operating this machine. Sawdust may cause allergic reactions or respiratory problems.</p>
--	--

	<p><b>!WARNING</b> Make sure loose clothing and long hair is secured and kept away from moving parts.</p>
--	---

	<p><b>!WARNING</b> Keep fingers away from the sanding back stop and belt. Otherwise, you can be injured.</p>
--	--

To sand the edge or end of a workpiece, do these steps:

1. Put your safety glasses and dust mask on, start the dust collector and your sander.
2. Adjust the main table to the needed height and set the table tilt to the needed angle.

<p><b>!WARNING</b> DO NOT sand a workpiece with the sharp corners at the leading-edge of the sanding operation. The belt can grab and propel the workpiece causing injury. See Figure 46.</p>
---

3. Set the workpiece on the table.
4. Carefully sand the workpiece with the grain in the belt direction and use the back stop. See Figure 47.

**⚠️ WARNING**

DO NOT sand a workpiece with the sharp corners at the leading-edge of the sanding operation. The belt can grab and propel the workpiece causing injury. See Figure 48.

5. Set the miter gauge to the needed angle.
6. Set the workpiece on the table and against the miter gauge. See **Figure 49**.
7. Carefully sand the wood with sharp corners at the trailing-edge of the sanding operation. See **Figure 49**.



**Figure 48.** DO NOT sand wood with sharp corners at the leading-edge of the sanding operation. The belt can grab and throw the wood.

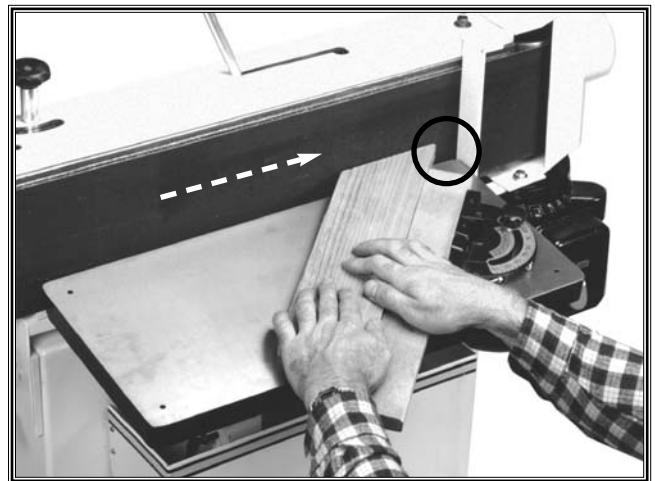

**Figure 49.** ALWAYS sand wood with sharp corners at the trailing-edge of the sanding operation.

# Horizontal Sanding

The steps below show you how to sand the face of a basic workpiece.

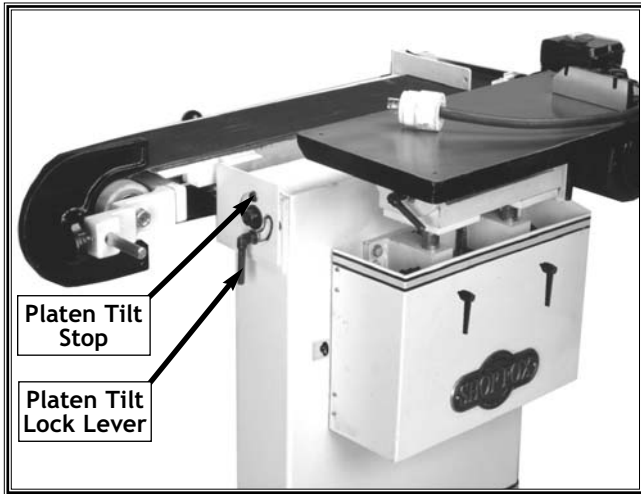

**Figure 50.** Platen seated in horizontal position against stop with the lock lever tightened.



**Figure 51.** Incorrect face sanding away from back stop.



**Figure 52.** Correct face sanding.



**! WARNING**  
Always wear a dust mask and safety glasses when operating this machine. Sawdust may cause allergic reactions or respiratory problems.



**! WARNING**  
Make sure loose clothing and long hair is secured and kept away from moving parts.



**! WARNING**  
Keep fingers away from the sanding back stop and belt. Otherwise, you can be injured.

To sand the face of a workpiece, do these steps:

1. Put your safety glasses and dust mask on, start the dust collector and your sander.
2. Tilt platen from the vertical position to the horizontal position and lock. See Figure 50.

**! WARNING**  
Make sure you adjust the vertical belt tracking. **DO NOT** ignore this adjustment. Otherwise, the belt can immediately run off the sander when the sander is started and cause personal injury.

3. Adjust the vertical belt tracking. Ref. Page 19.
4. Set the workpiece against the back stop and on the table.
5. Carefully sand the workpiece so the grain follows the belt direction with even pressure back and fourth along the back stop. See Figure 52.

# Contour Sanding

The steps below show you how to sand the rounded contours of a basic workpiece.

	<p><b>!WARNING</b></p> <p>Always wear a dust mask and safety glasses when operating this machine. Sawdust may cause allergic reactions or respiratory problems.</p>
---	---

	<p><b>!WARNING</b></p> <p>Make sure loose clothing and long hair is secured and kept away from moving parts.</p>
---	--

	<p><b>!WARNING</b></p> <p>Keep fingers away from the sanding back stop and belt. Otherwise, you can be injured.</p>
--	---

To sand the contour of a workpiece, do these steps:

1. Put your safety glasses and dust mask on, start the dust collector and your sander.
2. Adjust the auxiliary table height to the center of the tapered idler roller and tighten the lock knob. See Figure 53.

<p><b>!WARNING</b></p> <p>DO NOT sand a workpiece with the sharp corners at the leading-edge of the sanding operation. The belt can grab and propel the workpiece causing injury.</p>
---

3. Set the workpiece on the auxiliary table.
4. Carefully sand the workpiece so the grain follows the belt direction with even pressure. See Figure 55.



Figure 53. Auxiliary table adjusted height to center of idler roller.



Figure 54. DO NOT sand wood with your fingers close to the idler roller and belt.



Figure 55. ALWAYS keep your fingers away from the idler roller and the belt.



# Troubleshooting

Use this troubleshooting chart to correct common edge sander problems.

SYMPTOM	POSSIBLE REASON	HOW TO REMEDY
The sander wobbles or vibrates.	The mobile base, stand, or platform is loose or unstable.	Make sure all fasteners are tight, the rubber feet are installed, and the sander is operating on a flat floor.
	The motor or other components are loose, misaligned, or out of adjustment.	Make sure all fasteners and sander parts are tight and/or correctly adjusted.
The belt has broken.	The workpiece has been pushed into the belt with too much force, and/or has been pushed into the belt against the grain of the wood thus catching and tearing the belt.	<ol style="list-style-type: none"> <li>1. Push the workpiece into the belt with less force, and use a coarser grit belt.</li> <li>2. Dress or replace belts when needed.</li> <li>3. Only sand wood with the grain and in the proper sanding direction using the back stop.</li> </ol>
	There is too much belt tension for the belt being used.	Reduce the belt tension, but NOT so the belt is too loose.
	The belt is worn out, or the belt splice is defective.	<ol style="list-style-type: none"> <li>1. Replace the belt, and contact the belt manufacturer.</li> <li>2. Follow all belt-manufacturer storage and handling instructions.</li> </ol>
	The idler or drive roller is out of alignment.	Re-align the roller system.
	A previous fault at one time has damaged the belt.	Replace the belt.
The sander will not start.	There is no power to the wall receptacle or the sander power cord.	Plug in the power cord and close the applicable shop power switch.
	The circuit breaker or fuse has tripped.	<ol style="list-style-type: none"> <li>1. Get a qualified electrician to troubleshoot and correct the cause for the circuit breaker or fuse trip.</li> <li>2. Use another circuit capable of the increased amperage load.</li> </ol>
	The power cord, or extension cord is damaged.	Replace the power cord or extension cord.

(Continued Next Page)

(Troubleshooting Continued)

SYMPTOM	POSSIBLE REASON	HOW TO REMEDY
<p>The sander runs slow.</p>	<p>The extension cord used is the wrong gauge and has too much resistance.</p> <p>The motor is wired incorrectly.</p> <p>The supply circuit has low voltage and/or high resistance.</p>	<p>Eliminate the extension cord and move the sander closer to the wall receptacle.</p> <p>Contact a qualified electrician if you are unqualified to do this task: Rewire the junction box for 110V or 220V as outlined in wiring diagram and on the motor data plate.</p> <p>Get a qualified electrician to make sure the supply circuit used has the load carrying capacity for your sander and all other machines using the same circuit.</p>
<p>The belt tears or runs off of the sander.</p>	<p>The belt tension is too low. As a result, the belt has run off of the rollers because of slipping from the sanding load.</p> <p>The drive roller and/or the idler roller are not aligned.</p> <p>The belt is sanding in the wrong direction, it is worn out, or is defective.</p>	<p>Increase the belt tension to prevent slippage. DO NOT over tighten the belt tension.</p> <p>Align the rollers and adjust the vertical belt tracking.</p> <p>Install a new belt with the belt rotation arrows pointing in the correct direction for sander operation.</p>
<p>The abrasive belt has worn out quickly.</p>	<p>The workpiece has been pushed too hard against the sanding belt ruining the belt.</p> <p>The belt loses the abrasive surface quickly from moisture, heat, or oil.</p> <p>The belt is clogged with sanding material.</p>	<p>Replace the belt and decrease how hard you push on the work piece.</p> <p>Replace belts that have been improperly stored in extremely hot or damp places.</p> <p>Keep belts dressed with belt dressing blocks.</p>
<p>The sanded surface is burnt or glazed.</p>	<p>The workpiece has been pushed too hard against the sanding belt.</p> <p>The sanding belt grit is too fine.</p> <p>The belt is worn out or it is loaded up with dust.</p>	<p>Decrease how hard you are pushing and keep workpiece moving.</p> <p>Use coarse grit belt and then finish with a fine-grit sanding belt.</p> <ol style="list-style-type: none"> <li>1. Dress the belt.</li> <li>2. Match the correct belt with the material to be sanded.</li> <li>3. Replace worn belts.</li> </ol>

(Continued Next Page)

(Troubleshooting Continued)

SYMPTOM	POSSIBLE REASON	HOW TO REMEDY
<p>The sanded surface has scratches and/or has ridges.</p>	<p>The workpiece has been held against the belt in one position.</p> <p>The workpiece has been pushed too hard against the sanding belt.</p> <p>The workpiece has been sanded against the grain.</p> <p>The belt is worn or loaded up with particles.</p> <p>The belt grit is the too coarse for your anticipated sanding results.</p> <p>The roller(s) or platen graphite has foreign objects imbedded and/or there is surface damage.</p>	<p>Keeping the workpiece against the back stop, and move the workpiece around on the sanding surface slightly.</p> <p>Decrease how hard you are pushing on the workpiece.</p> <p>Only sand with the grain.</p> <p>Dress the belt-sanding surface.</p> <p>Change to a new belt.</p> <ol style="list-style-type: none"> <li>1. Replace the roller(s).</li> <li>2. Replace the platen graphite pad.</li> </ol>
<p>The sanded surface is tapered and not square.</p>	<p>The platen is tilted, or it is not perpendicular to the main table.</p> <p>Auxiliary sanding is occurring at the top or bottom portion of the idler roller.</p>	<ol style="list-style-type: none"> <li>1. Align or level the platen to table.</li> <li>2. The idler roller is tapered; adjust the auxiliary table to guide the workpiece to the center of the idler roller.</li> </ol> <p>Align the table with the rollers.</p>
<p>The sanded surface sanded at the auxiliary table and idler roller is uneven or tapered.</p>	<p>You are not sanding at the center of the idler roller, but rather at the top or bottom portion of the idler roller where it is tapered.</p> <p>Sawdust, pitch, or oil has built up on the rollers(s) creating an uneven surface under the belt.</p>	<p>Adjust the auxiliary table to hold the workpiece at the center of the idler roller while sanding.</p> <ol style="list-style-type: none"> <li>1. Service the dust collection system.</li> <li>2. Remove the belt and clean the idler and drive roller surfaces.</li> </ol>

This Page Intentionally Left Blank

# MAINTENANCE

## General

Regular periodic maintenance on your Model W1688 will ensure its optimum performance. Make a habit of inspecting your machine each time you use it. Check for the following conditions and repair or replace when necessary.

1. Loose mounting bolts.
2. Worn switch.
3. Worn or damaged cords and plugs.
4. Damaged sanding belt.
5. Any other condition that could hamper the safe operation of this machine.

## Lubrication and Cleaning

Since all bearings are shielded and permanently lubricated, simply leave them alone until they need to be replaced. Do not lubricate them, as this will only attract dust and cause possible premature bearing failure.

DO NOT oil any exposed areas on the sander. Dust will be attracted to these areas, creating a gummy mixture that can hamper proper movement of components.



**Figure 56.** Routinely clean sanding belts with PRO-STIK® belt cleaners.

Lubricate exposed areas with dry powdered graphite instead.

Because sanders produce more sawdust than most other woodworking machines, take extra care to vacuum off areas that accumulate sawdust and abrasive belts. If left to build up, the dust and abrasive belts will contaminate the motor, bearings, and other moving parts of the machine. Eventually the dust and abrasive belts will damage the sander.

If any part of the sander becomes difficult to operate, it is most likely caused by an accumulation of sawdust. Immediately investigate the area and remove any sawdust. Or contact Woodstock International, Inc. Service and Support at 1-360-734-3482 or send e-mail to: [tech-support@shopfox.biz](mailto:tech-support@shopfox.biz).

## Table and Base

Keep the tables and base rust-free with regular applications of products like SLIP-IT®. For long term storage you may want to consider products like Boeshield® T-9.

## Sanding Belts

As sanding belts are used, they will quickly become "loaded" with sawdust. If not removed, this sawdust will harden on the abrasive surface, rendering the belts useless. Routinely clean the sanding belts with a rubber gum abrasive cleaner as shown in **Figure 56**.

Always discard worn sanding belts. As abrasive belts begin to wear, grit will begin to fall off causing deep gouges in the workpiece. Glue used to hold the grit to the paper will rub off onto the workpiece causing burns and interference with final finishing.

### NOTICE

Contrary to some beliefs, worn abrasive belts are not the equivalent the next finer grit abrasive. Discard worn sanding belts and avoid the temptation to use them beyond their usable life.

# W1688 Edge Sander Wiring Diagram

## ⚠️ WARNING

Seek assistance from a qualified electrician if you do not understand the wiring diagram in this manual, and always follow the applicable electrical codes and standards. Otherwise serious personal injury or death may occur!



## ⚠️ WARNING

Keep your machine unplugged during all electrical service and wiring procedures. Otherwise serious personal injury may occur!

### 220 VOLT CONNECTION

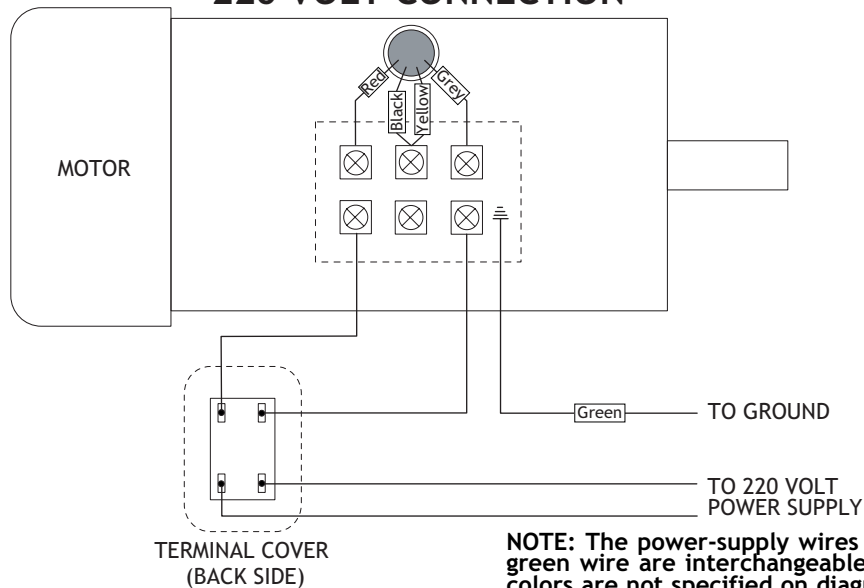

**NOTE:** The power-supply wires besides the green wire are interchangeable. Therefore colors are not specified on diagram.

### 110 VOLT CONNECTION

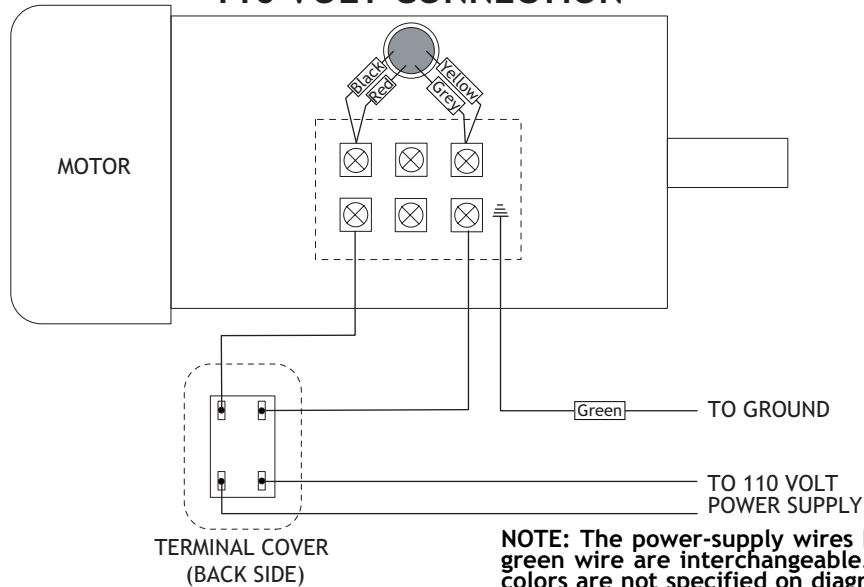

**NOTE:** The power-supply wires besides the green wire are interchangeable. Therefore colors are not specified on diagram.

# CLOSURE

The following pages contain parts diagrams/lists and a warranty card for your **SHOP FOX®** Model W1688.

If you need parts or help in assembling your machine, or if you need operational information, we encourage you to call our Service Department. Our trained service technicians will be glad to help you.

If you have comments dealing specifically with this manual, please write to us using the address in the General Information. The specifications, drawings, and photographs illustrated in this manual represent the Model W1688 as supplied when the manual was prepared. However, due to Woodstock International, Inc.'s policy of continuous improvement, changes may be made at any time with no obligation on the part of Woodstock International, Inc. Whenever possible, though, we send manual updates to all owners of a particular tool or machine that have registered their purchase with our warranty card. Should you receive one, add the new information to this manual and keep it for reference.

We have included some important safety measures that are essential to the operation of the machine. While most safety measures are generally universal, we remind you that each workshop is different and safety rules should be considered as they apply to your specific situation.

We recommend you keep this manual for complete information regarding Woodstock International, Inc.'s warranty and return policy. Should a problem arise, we recommend that you keep your proof of purchase with your manual. If you need additional technical information relating to this machine, or if you need general assistance or replacement parts, please contact the Service Department at 1-360-734-3482 or e-mail: [tech-support@shopfox.biz](mailto:tech-support@shopfox.biz).

Additional information sources are necessary to realize the full potential of this machine. Trade journals, woodworking magazines, and your local library are good places to start.

The Model W1688 is specifically designed for sanding operations. **DO NOT MODIFY AND/OR USE THIS MACHINE FOR ANY OTHER PURPOSE. MODIFICATIONS OR IMPROPER USE OF THIS TOOL WILL VOID THE WARRANTY.** If you are confused about any aspect of this machine, **DO NOT** use it until all your questions have been answered.

 <b>WARNING</b>		
<p>Operating this equipment has the potential for flying debris to cause eye injury. Always wear safety glasses or goggles when operating equipment. Everyday glasses or reading glasses only have impact resistant lenses, they are not safety glasses. Be certain the safety glasses you wear meet the appropriate standards of the American National Standards Institute (ANSI).</p>		
		

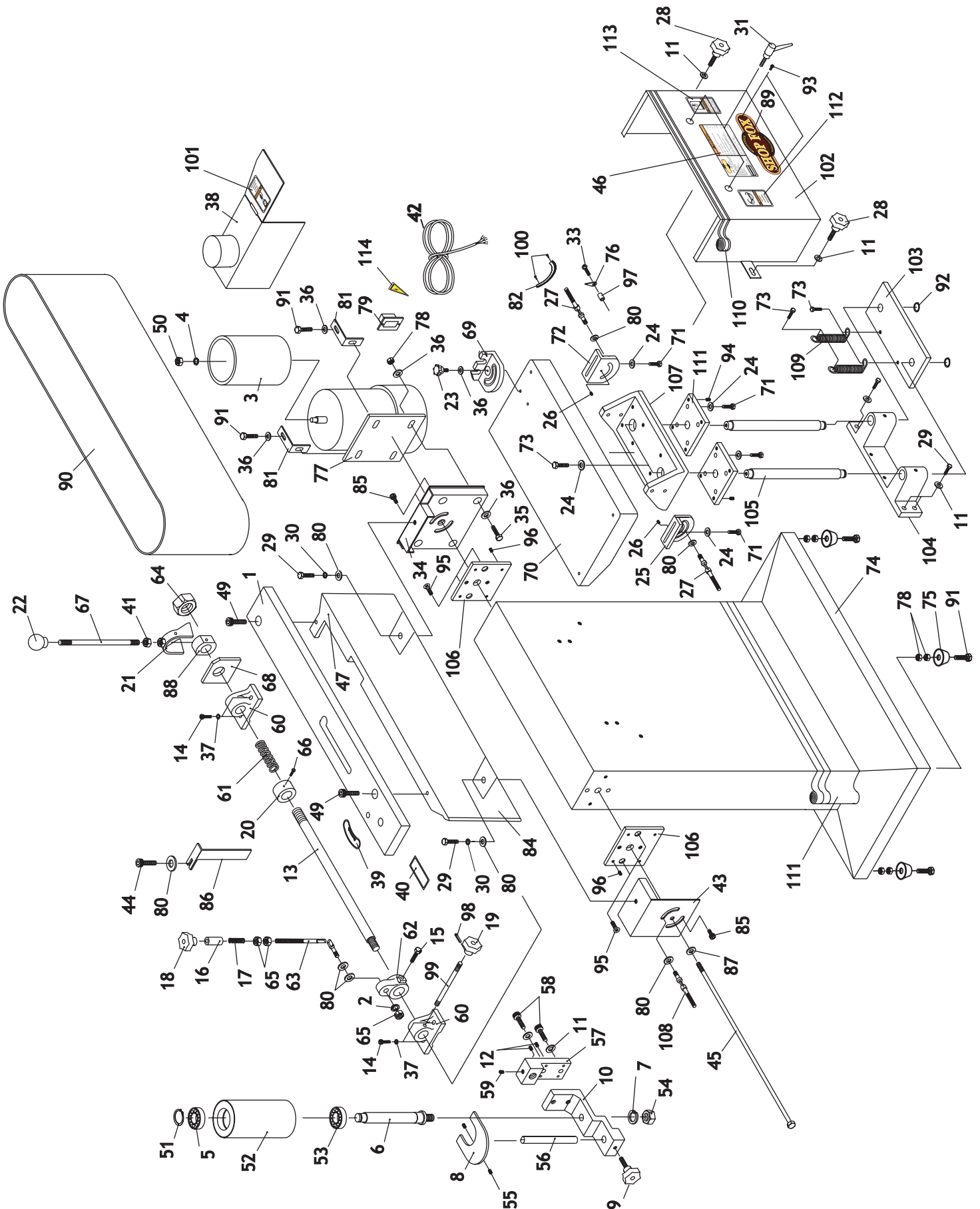



REF	PART #	DESCRIPTION
01	X1688001	PLATEN COVER
02	XPLW04	LOCK WASHER 3/8"
03	X1688003	DRIVE ROLLER
04	XPLW06	LOCK WASHER 5/8"
05	XP6204	BEARING 6204
06	X1688006	ROLLER AXLE
07	XPLW06	LOCK WASHER 5/8"
08	X1688008	AUXILIARY TABLE
09	X1688009	KNOB BOLT
10	X1688010	ROLLER SUPPORT BRACKET
11	XPW06	FLAT WASHER 1/4"
12	XPSS10	SET SCREW 1/4"-20 X 5/8"
13	X1688013	BELT ADJUST SHAFT
14	XPSB03	CAP SCREW 5/16"-18 X 1"
15	XPB86	HEX BOLT 5/16"-18 X 3/4"
16	X1688016	SLEEVE
17	X1688017	SPRING
18	X1688018	KNOB
19	X1688019	KNOB
20	X1688020	COLLAR
21	X1688021	SWIVEL SADDLE
22	X1688022	KNOB
23	X1688023	KNOB
24	XPW07	FLAT WASHER 5/16"
25	X1688025	TRUNNION, LEFT
26	XPSS01	SETSCREW 5/16"-18 X 1"
27	X1688027	LEVER SCREW
28	X1688028	KNOB BOLT
29	XPB16	HEX BOLT 3/8"-16 X 1-1/2"
30	XPLW04	LOCK WASHER 3/8"
31	XPB67	HEX BOLT 5/16"-18 X 1-1/2"
33	XPS08	PHLP HD SCR 10-24 X 3/4"
34	X1688034	MOTOR BRACKET
35	XPB12	HEX BOLT 5/16"-18 X 1 1/4"
36	XPW07	FLAT WASHER 5/16"
37	XPLW01	LOCK WASHER 5/16"
38	X1688038	DUST COLLECTION HOOD
39	X1688039	LABEL (BELT TRACKING KNOB)
40	X1688040	LABEL (BELT LOCK KNOB)
41	XPN13	HEX NUT 1/2" X 13
42	X1688042	POWER CORD
43	X1688043	BRACKET
44	XPSB14	CAP SCREW 3/8"-16 X 1"
45	X1688045	SPECIAL LOCK BOLT
46	X1688046	LABEL (MACHINE DATA)
47	X1688047	PLATEN
49	XPSB14	CAP SCREW 3/8"-16 X 1"
50	XPN09	HEX NUT 5/8"-18
51	XPR09M	EXT RETAINING RING 20MM
52	X1688052	RUBBER IDLER ROLLER
53	XP6205	BEARING 6205

REF	PART #	DESCRIPTION
54	XPN04	HEX NUT 5/8"-11
55	XPSS17	SET SCREW 5/16"-18 X 5/16"
56	X1688056	AUXILIARY TABLE POST
57	X1688057	ROLLER BLOCK BRACKET
58	XPSB26	CAP SCREW 3/8"-16 X 1 1/2"
59	XPSS10	SET SCREW 1/4"-20 X 5/8"
60	X1688060	ADJUST SHAFT SLIDE
61	X1688061	SPRING
62	X1688062	ARM CONTROL CASTING
63	X1688063	CONTROL SHAFT
64	X1688064	HEX NUT 1"-8
65	XPN22	HEX NUT 3/8"-16
66	XPN08	HEX BOLT 3/8"-16 X 3/4"
67	XPB21	LEVER
68	X1688068	PLATE
69	X1688069	MITER GAUGE BODY
70	X1688070	TABLE
71	XPB03	HEX BOLT 5/16"-18 X 1"
72	X1688072	TRUNNION, RIGHT
73	XPB09	HEX BOLT 5/16"-18 X 1/2"
74	X1688074	STAND
75	X1688075	FEET
76	X1688076	POINTER
77	X1688077	MOTOR
78	XPN02	HEX NUT 5/16"-18
79	X1688079	SWITCH
80	XPW02	FLAT WASHER 3/8"
81	X1688081	BRACKET
82	X1688082	ANGLE SCALE
84	X1688084	GRAPHITE PAD
85	X1688085	PLATEN TILT STOP
86	X1688086	BACK STOP
87	X1688087	SPECIAL WASHER
88	X1688088	SWIVEL COLLAR
89	X1688089	PLATE (SHOP FOX LOGO)
90	X1688090	ABRASIVE BELT
91	XPB09	HEX BOLT 5/16"-18 X 1/2"
92	XPR08M	EXT RETAINING RING 19MM
93	XPS50M	PHLP HD SCREW M3-0.5 X 10
94	XPSS08	SET SCREW 5/16"-18 X 1/2"
95	XPFH14	FLAT-HD ALLEN SCREW 5/16"-18 X 3/4"
96	XPSS17	SET SCREW 5/16"-18 X 5/16"
97	W188097	SLEEVE
98	XPRP02M	ROLL PIN 3MM X 16
99	X1688099	LOCK ROD
100	X1688100	RIVET
101	X1688101	LABEL (UNPLUG POWER)
102	X1688102	MAIN COVER
103	X1688103	PLATE
104	X1688104	SHAFT SLIDE
105	X1688105	SHAFT



---

---

REF	PART #	DESCRIPTION
106	X1688106	TILT PLATE
107	X1688107	TABLE SUPPORT
108	X1688108	LEVER SCREW
109	X1688109	SPRING
110	X1688110	NARROW STRIPE TAPE

REF	PART #	DESCRIPTION
111	X1688111	WIDE STRIPE TAPE
112	X1688112	LABEL (WEAR SAFETY GLASSES)
113	X1688113	LABEL (READ MANUAL)
114	X1688114	LABEL (SHOCK HAZARD)

---

# YOUR NOTES



---

# YOUR NOTES

FOLD ALONG DOTTED LINE

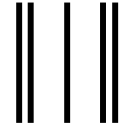
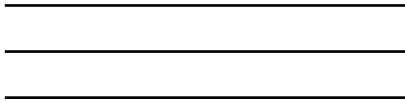

Place  
Stamp  
Here



WOODSTOCK INTERNATIONAL, INC.  
P.O. BOX 2309  
BELLINGHAM, WA 98227-2309



FOLD ALONG DOTTED LINE

TAPE ALONG EDGES--PLEASE DO NOT STAPLE



# WARRANTY CARD

Name \_\_\_\_\_  
 Street \_\_\_\_\_  
 City \_\_\_\_\_ State \_\_\_\_\_ Zip \_\_\_\_\_  
 Phone Number \_\_\_\_\_ E-Mail \_\_\_\_\_ FAX \_\_\_\_\_  
 MODEL # \_\_\_\_\_ Serial # \_\_\_\_\_

The following information is given on a voluntary basis and is strictly confidential.

CUT ALONG DOTTED LINE

ADJUSTMENTS

- Where did you purchase your **SHOP FOX®** machine?  
\_\_\_\_\_
- How did you first learn about us?  
 Advertisement                       Friend  
 Mail order Catalog                       Local Store  
 World Wide Web Site  
 Other \_\_\_\_\_
- Which of the following magazines do you subscribe to.  
 American Woodworker                       Today's Homeowner  
 Cabinetmaker                       Wood  
 Family Handyman                       Wooden Boat  
 Fine Homebuilding                       Woodshop News  
 Fine Woodworking                       Woodsmith  
 Home Handyman                       Woodwork  
 Journal of Light Construction                       Woodworker  
 Old House Journal                       Woodworker's Journal  
 Popular Mechanics                       Workbench  
 Popular Science                       American How-To  
 Popular Woodworking  
 Other \_\_\_\_\_
- Which of the following woodworking/remodeling shows do you watch?  
 Backyard America                       The New Yankee Workshop  
 Home Time                       This Old House  
 The American Woodworker                       Woodwright's Shop  
 Other \_\_\_\_\_
- What is your annual household income?  
 \$20,000-\$29,999                       \$60,000-\$69,999  
 \$30,000-\$39,999                       \$70,000-\$79,999  
 \$40,000-\$49,999                       \$80,000-\$89,999  
 \$50,000-\$59,999                       \$90,000 +
- What is your age group?  
 20-29                       50-59  
 30-39                       60-69  
 40-49                       70 +
- How long have you been a woodworker?  
 0 - 2 Years                       8 - 20 Years  
 2 - 8 Years                       20+ Years
- How would you rank your woodworking skills?  
 Simple                       Advanced  
 Intermediate                       Master Craftsman
- How many SHOP FOX® machines do you own? \_\_\_\_\_
- What stationary woodworking tools do you own? Check all that apply.  
 Air Compressor                       Panel Saw  
 Band Saw                       Planer  
 Drill Press                       Power Feeder  
 Drum Sander                       Radial Arm Saw  
 Dust Collector                       Shaper  
 Horizontal Boring Machine                       Spindle Sander  
 Jointer                       Table Saw  
 Lathe                       Vacuum Veneer Press  
 Mortiser                       Wide Belt Sander  
 Other \_\_\_\_\_
- Which benchtop tools do you own? Check all that apply.  
 1" x 42" Belt Sander                       6" - 8" Grinder  
 5" - 8" Drill Press                       Mini Lathe  
 8" Table Saw                       10" - 12" Thickness Planer  
 8" - 10" Bandsaw                       Scroll Saw  
 Disc/Belt Sander                       Spindle/Belt Sander  
 Mini Jointer  
 Other \_\_\_\_\_
- Which portable/hand held power tools do you own? Check all that apply.  
 Belt Sander                       Orbital Sander  
 Biscuit Joiner                       Palm Sander  
 Circular Saw                       Portable Planer  
 Detail Sander                       Saber Saw  
 Drill/Driver                       Reciprocating Saw  
 Miter Saw                       Router  
 Other \_\_\_\_\_
- What machines/supplies would you like to see?  
 \_\_\_\_\_  
 \_\_\_\_\_  
 \_\_\_\_\_
- What new accessories would you like Woodstock International to carry?  
 \_\_\_\_\_  
 \_\_\_\_\_
- Do you think your purchase represents good value?  
 Yes                       No
- Would you recommend SHOP FOX® products to a friend?  
 Yes                       No
- Comments: \_\_\_\_\_  
 \_\_\_\_\_  
 \_\_\_\_\_  
 \_\_\_\_\_  
 \_\_\_\_\_



