

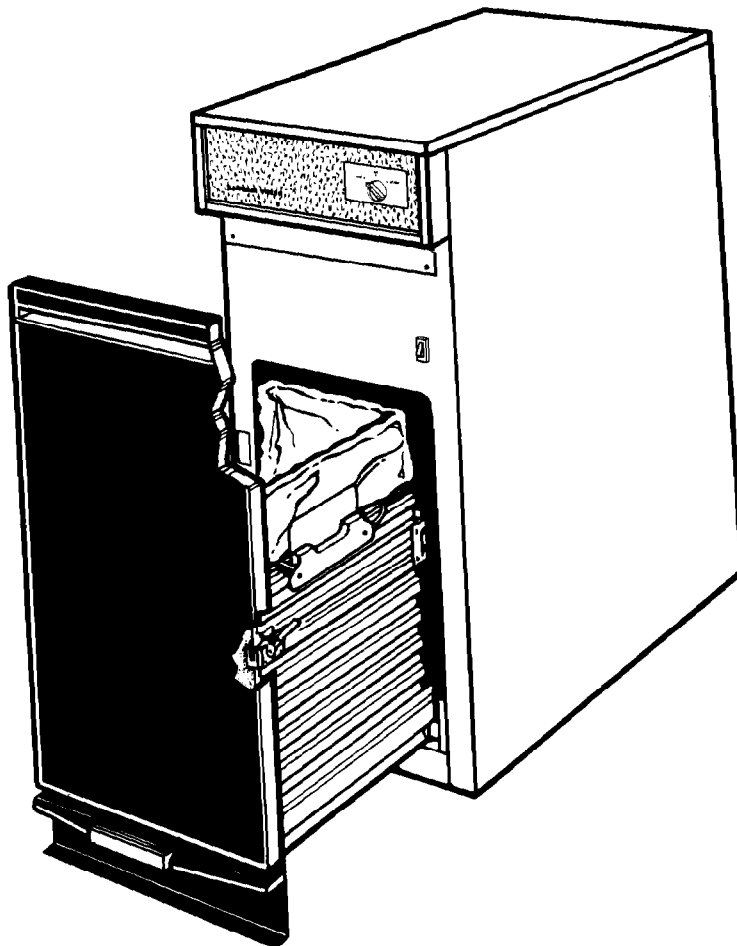

# Instructions for Installation and Use



## Freestanding Compactor

220-240-volt, 50-Hz Models

# Contents

	Page
<b>Before Using the Compactor</b> .....	1
<b>Important Safety Instructions</b> .....	2
Electrical Requirements .....	2
Precautions and general suggestions .....	2
<b>Installation Instructions</b> .....	3
Before you start .....	3
Tools and materials needed for installation .....	4
Now start .....	4
Adjusting the toe plate .....	6
<b>Description of the Appliance</b> .....	7
<b>Using Your Compactor</b> .....	8
Removing a filled bag .....	10
Installing a new bag .....	11
<b>How Your Compactor Works</b> .....	12
<b>Caring For Your Compactor</b> .....	13
<b>Changing Your Compactor's Colour</b> .....	15
<b>Troubleshooting Guide/Service</b> .....	16
<b>Whirlpool Compactor Warranty</b> .....	16

---

### Thank you for buying a WHIRLPOOL\* appliance.

Please complete the form below. Have this information ready if you need service or call with a question.

- Copy model and serial numbers from plate (see diagram on page 7) and purchase date from sales slip.
- Keep this book and sales slip together in a handy place.

---

**Model Number**

---

**Serial Number**

---

**Purchase Date**

---

**Retailer Phone Number**

# Before Using the Compactor

- After unpacking, make sure that the appliance is undamaged and that the door opens and closes properly. Any damage must be reported to your retailer within 24 hours after delivery of the appliance.
- The packaging box is recyclable and is marked with the recycling symbol ♻.
- The appliance is built with reusable material. When scrapping, follow the local environment protection disposal regulations. Do not dump the appliance. Take it to the local disposal centre.
- Make sure that the installation and the electrical connection are carried out by a qualified technician according to the manufacturer's instructions and local safety regulations.
- Read "Important Safety Instructions" on page 2 before installing or using the compactor.

# Important Safety Instructions

## Electrical Requirements

1. A 230 volt 50Hz ac only 15 ampere fused electrical supply is required.
2. A time delay fuse or circuit breaker is recommended. It is also recommended that a separate circuit serving only this appliance be provided.
3. Use a power point which cannot be turned off with a switch or pull chain. Do not use an extension cable.
4. For your personal safety, the compactor must be earthed. Check with a qualified technician if you are not sure that the compactor is properly earthed.

**IMPORTANT:** Observe all governing codes and ordinances.

## Precautions and general suggestions

- Do not allow the compactor to be used as a toy, or to run unattended at any time. Remove Key-knob when not in use and store Key-knob out of reach of children.
- Do not compact:
  - lighted cigarettes, cigars, or other hot or burning items
  - any container or aerosol can containing insecticide, hair spray, paint, engine starting fluid or other poisonous, toxic, or explosive products
  - volatile flammable materials such as oily rags, thinner, etc., which would create a fire hazard or explosion
- Never lift bag by the sides. Broken glass or other sharp objects in the bag can cause injury.
- Before carrying out any maintenance or cleaning, always unplug the appliance or disconnect the power supply.
- Do not store or use gasoline or other flammable vapours and liquids in the vicinity of this or any other appliance. The fumes can create a fire hazard or explosion.

# Installation Instructions

## Cutout dimensions

Earthed electrical outlet must be 8 cm minimum from either side of wall and recessed 2 cm into wall.

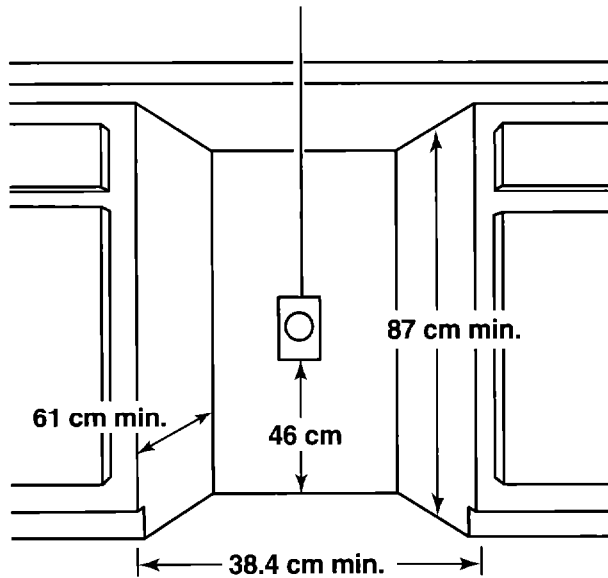

## Clearance dimensions

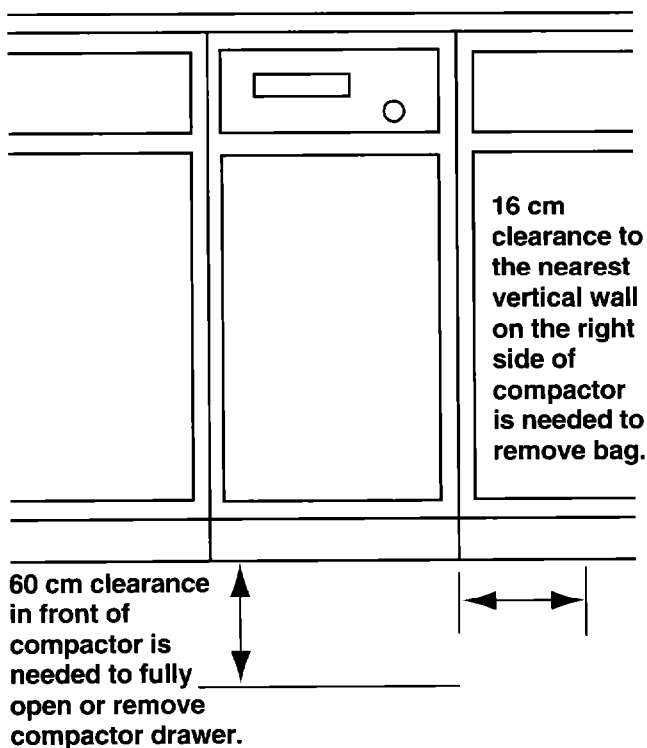

### IMPORTANT:

**Installer:** Leave installation instructions with the homeowner.

**Homeowner:** Keep installation instructions for future reference.

**Save** installation instructions for local electrical inspector's use.

## Before you start

You are responsible for making sure that your compactor is properly installed and leveled on a floor that can support its weight. Make sure you have everything necessary for correct installation. It is the personal responsibility and obligation of the customer to contact a qualified installer to assure that electrical installation is in compliance with all governing codes and ordinances.

**An earthed electrical outlet** is required. See "Electrical Requirements" on page 2.

**Check the location** where your compactor will be installed. Do not install or store compactor where it will be exposed to the weather.

The cabinet opening should be square. You should be able to fully open the compactor drawer. Sixteen cm of clearance is needed on the right side of compactor drawer (when fully extended) to be able to remove compactor bag. Allow 60 cm in front of compactor to remove drawer.

**IMPORTANT:** Do not let any items fall or collect behind the compactor, as this may result in fire.

## Product dimensions

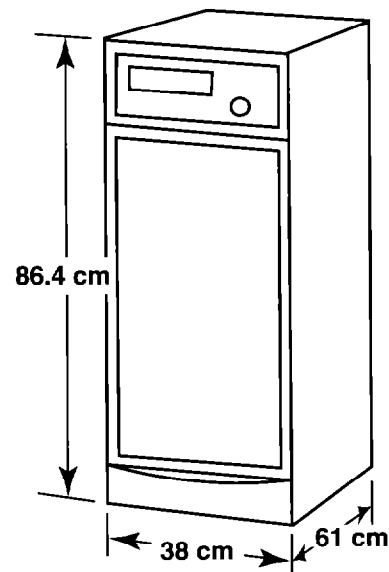

**NOTE:** Compactor height is adjustable. See Step 5 on page 5 for other heights.

## Tools and materials needed for installation:

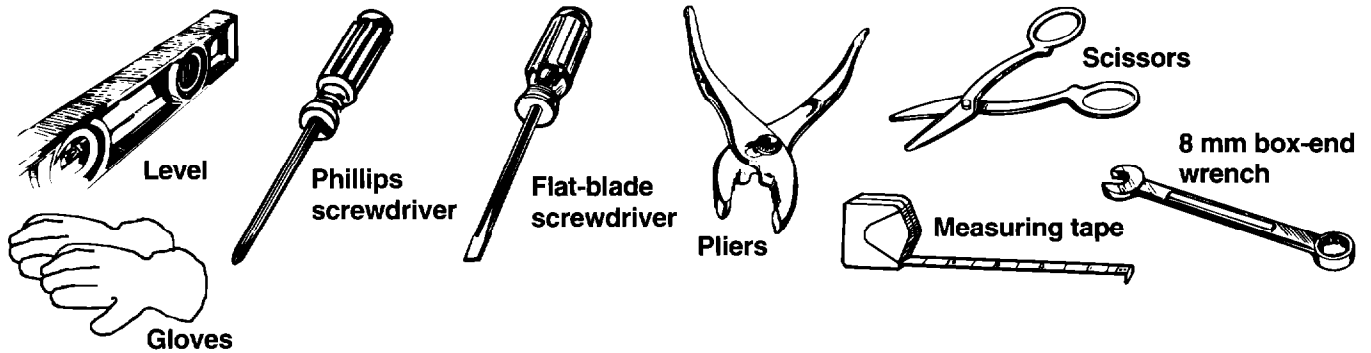

## Now start

**With compactor in room where it will be installed.**

**Do not grasp console to move compactor.**

**Slide compactor onto cardboard or hardboard before moving compactor across floor to prevent damaging floor covering.**

**Do not allow the rear frame of compactor to touch the floor covering when lifting or moving compactor.**

1. Remove compactor from shipping carton. Remove all protective packaging materials such as tape and shipping pads. Remove waxy residue caused by protective shipping material with a mild solution of liquid household cleaner and water.
2. Plug in power cord to compactor power inlet on the back panel. Power cord may be attached to cable clip.

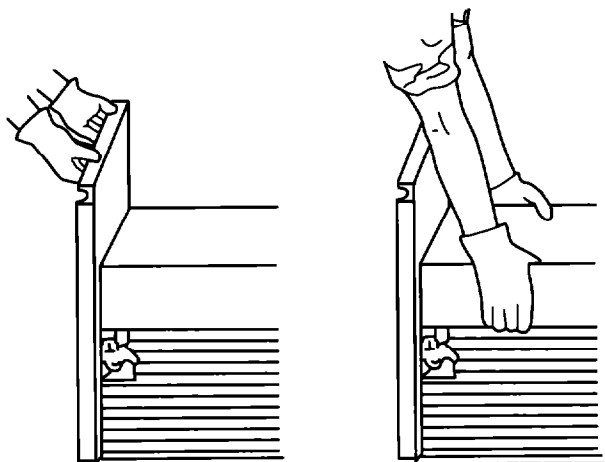
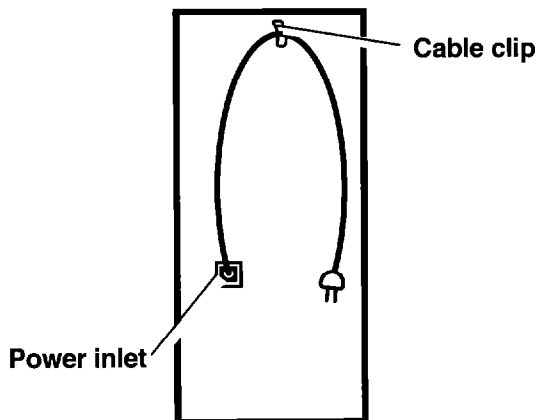

3. Place two corner posts from carton on floor near compactor. Open compactor drawer and remove any shipping materials or other items shipped in the drawer. Do not remove the compactor bag (if installed). Grasp the handle and raise the front of the drawer until it clears stops. Grasp sides of drawer and lift drawer out of compactor. Place the drawer on the two corner posts.

**IMPORTANT:** Use proper lifting methods in order to avoid injury.

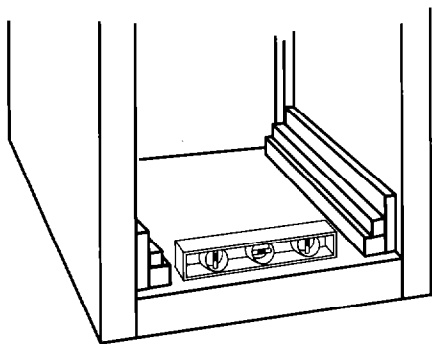
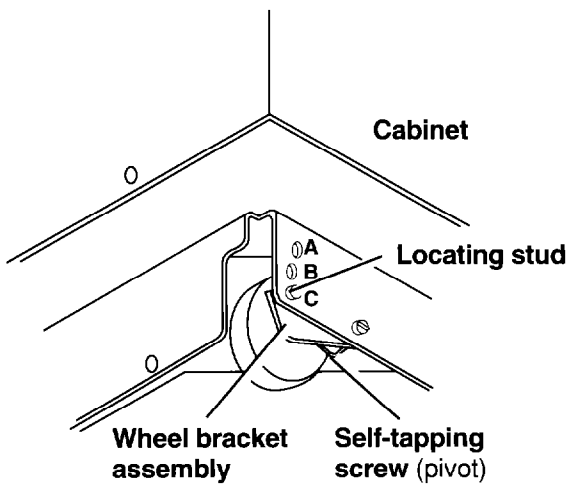
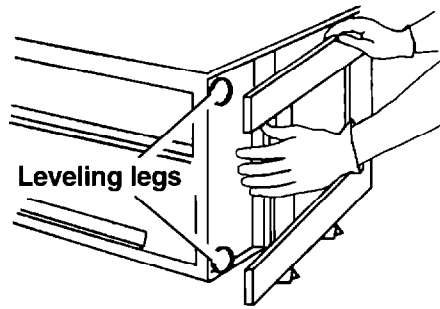

4. Place the other two corner posts on the floor to the side of the compactor. Grasp the sides of the compactor cabinet and put compactor on its side on top of the corner posts. Remove the shipping base from the bottom of compactor.

5. The rear wheels are preset for a cabinet opening height of 86.4 cm (Position "A"). To adjust for other heights, loosen screw just enough to clear stud from hole in Position "A." Move the rear wheel and stud to Position "B" or "C" as needed.

Position B: 87.4 cm

Position C: 88.1 cm

Tighten screw. Repeat for other rear wheel.

6. Place level inside on the floor of the cabinet. Check that the compactor is level from front to back and side to side. Adjust the leveling legs until the compactor is level.

7. Move the compactor close to its final position. Plug the power supply cable into a properly earthed receptacle.

**IMPORTANT:** When moving or lifting the compactor, use gloves to protect and cushion your hands.

8. Carefully move compactor into its final position. Check that compactor is still level. (See Step 6.)

**continued on next page**

## Installation Instructions Continued

9. Grasp sides of compactor drawer and place bottom of drawer into tracks. Lift at the handle so the front of drawer will go over drawer stops. Close drawer. Check if drawer opens freely. If the toe plate rubs against floor, see "Adjusting the toe plate" for further instructions.

### Adjusting the toe plate

If the toe plate rubs the floor covering, the toe plate clearance may be changed as follows:

- a. Mark on each side of the toe plate the amount of toe plate that rubs the floor covering.
- b. Remove the drawer from the unit. (See Step 3.)
- c. Use a rule and pencil or chalk to draw a line between the marks on each side of toe plate.
- d. Use scissors to cut toe plate along line.

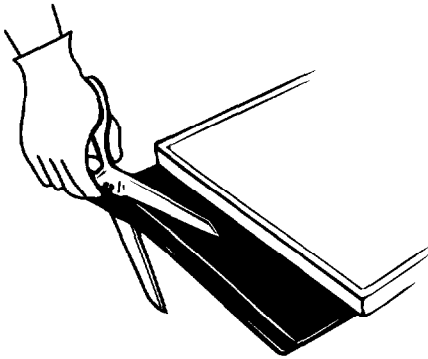

- e. Replace drawer. (See Step 9.) If toe plate still rubs floor covering, repeat steps a-e.

# Description of the Appliance

Below is an illustration of your appliance with the parts and features called out.

**NOTE:** The drawings in this book may vary from your compactor model. They are designed to show the different features of all models covered by this book. Your model may not include all features.

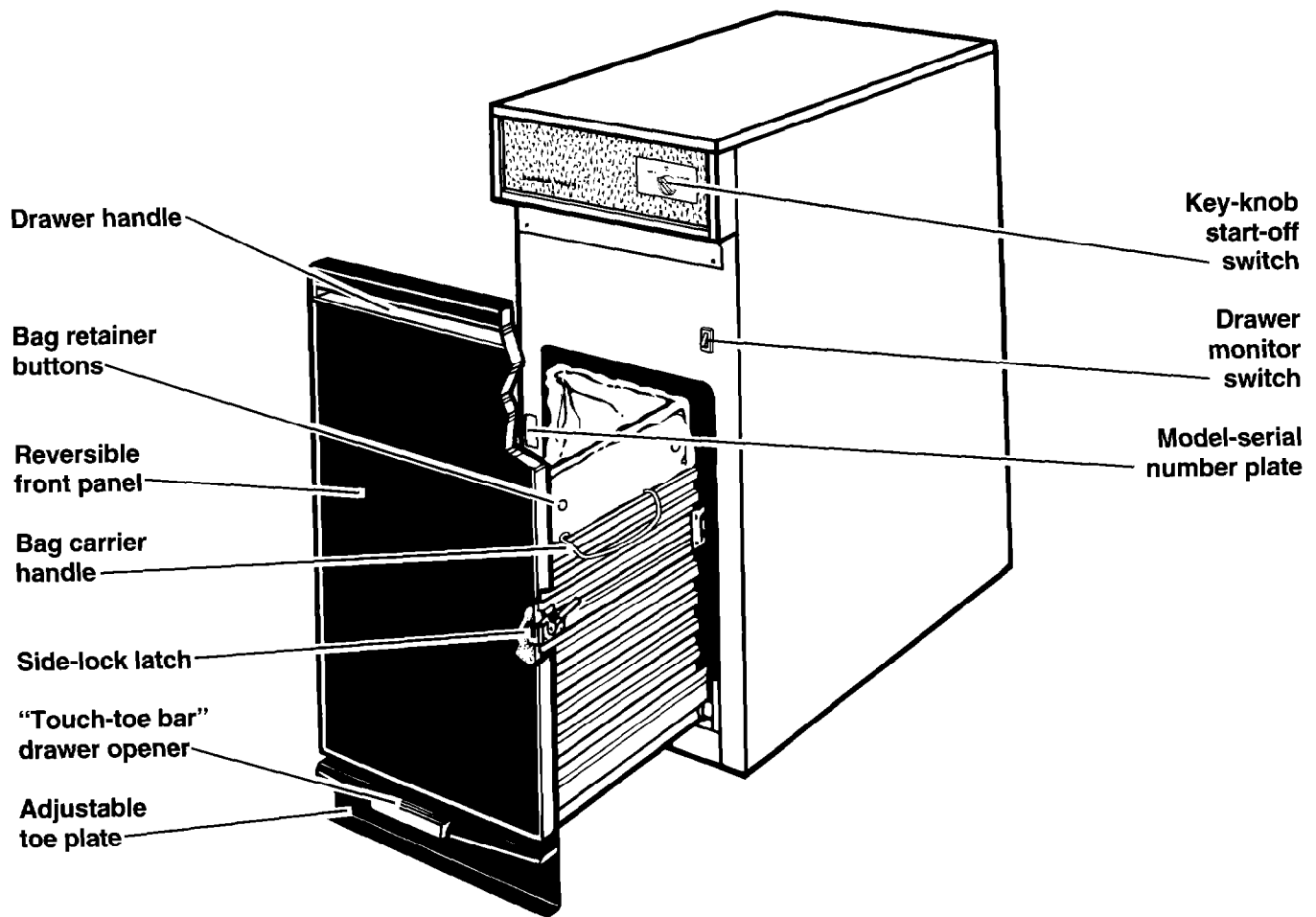



# Using Your Compactor

**IMPORTANT:** Do not compact any container, aerosol cans or cloths which might contain insecticide, hair spray, engine starting fluid, paints, liquids, thinners, or any poisonous or explosive products. If you compact these items, a fire or explosion could result.

Broken glass or sharp edges may be present in trash. Do not shove items down into compactor with feet or hands, risking cuts.

You are responsible for making sure that your compactor is used only for jobs normally expected of compactors.

- Do not use the compactor as a counter for electrical cooking appliances nor as a cutting board.
- Do not set hot pans, etc., on the compactor top. Do not spill any liquids on the compactor top.

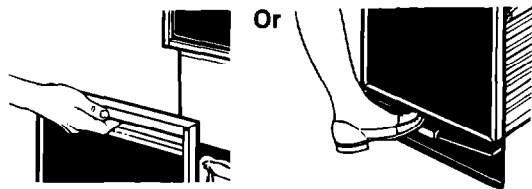

## Open the drawer:

Lift and pull the handle or press the Touch-toe bar to open the drawer.

## Put in the trash:

1. Wrap or cover wet or messy trash.
2. Load bottles or cans on their sides in the **centre** of the drawer. The waste paper below and beside the bottle can help keep broken glass near centre of bag.
3. Do not compact items that may develop offensive odors such as raw meat, fish, grapefruit rinds, disposable diapers, or personal hygiene items.

## Close the drawer:

Push drawer in until it stops.

## Start the compactor:

1. Turn the Key-knob to **START**.
2. Let the Key-knob go. The compactor will stop at the end of the cycle.

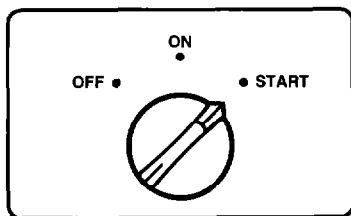

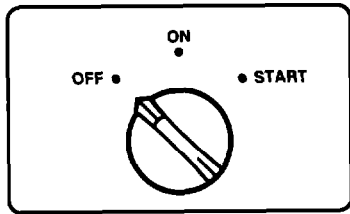

**To stop the compactor during a cycle:**

1. Turn the Key-knob to OFF.
2. Turn the Key-knob to ON. The compacting ram will rise.
3. When the ram stops rising, you can open the drawer.

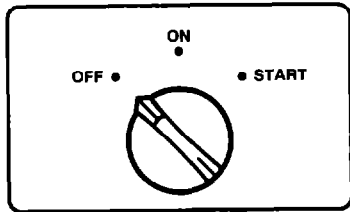

**To remove the Key-knob:**

1. Turn the Key-knob to the OFF position.
2. Remove and store Key-knob in a safe place out of children's reach.

## Removing a filled bag

When the trash is compacted to the top of the drawer, remove the bag. If the bag is too heavy, compact less trash before emptying in the future.

**IMPORTANT:** Sharp objects may protrude through bag after removal from compactor. Handle bag carefully.

1. Pull the drawer completely open.
2. Remove top of bag from bag retainer buttons. Pull up all 4 bag cuffs.

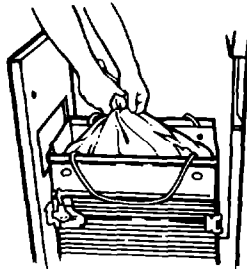
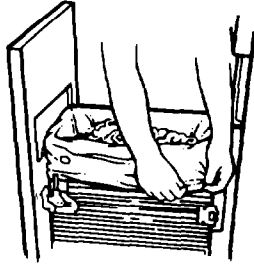

3. Close bag with twist tie provided.

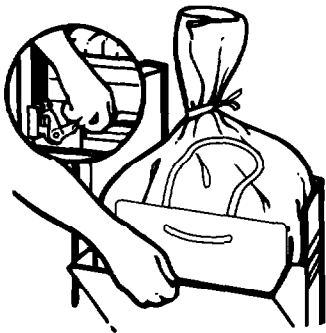

4. Push Side-lock latch down and tilt drawer side open.

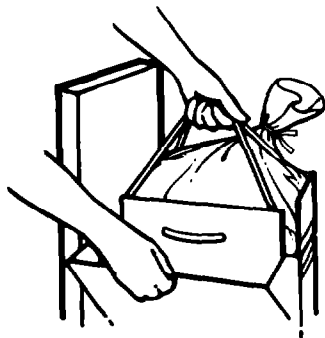

5. Lift bag by bag carrier handles.

## Installing a new bag

**Before installing a new bag, be sure:**

1. The drawer side is securely locked.
2. The container is clean and free of sharp debris that may puncture the bag.

Do not use any kind of bag other than those designed especially for use in your compactor.

Compactor bags may be purchased from your retailer.

1. Fit the bag caddy in the drawer.

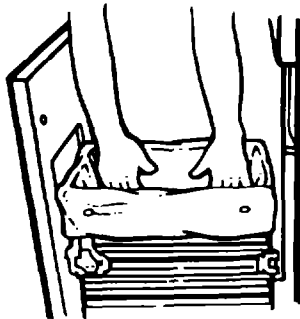
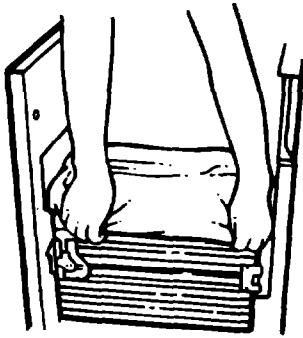
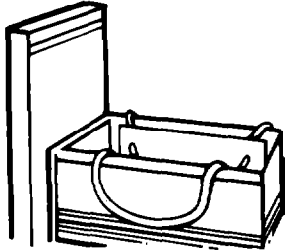

2. Place folded bag into the drawer. Open bag and pull top edges over the drawer top.
3. Lock bag in place by pulling the 4 prepunched holes over the bag retainer buttons. Holes will expand over the buttons without harming the bag.

4. Press inside of bag against the drawer bottom, sides and corners for a smooth fit.

# How Your Compactor Works

The compacting ram does not go to the drawer bottom. You will not see compacting of the first few loadings.

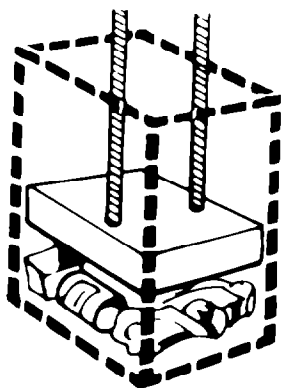

Compaction starts after the drawer is about  $\frac{1}{3}$  full. You may hear a noise when glass breaks. **Strong glass bottles may not break at all.**

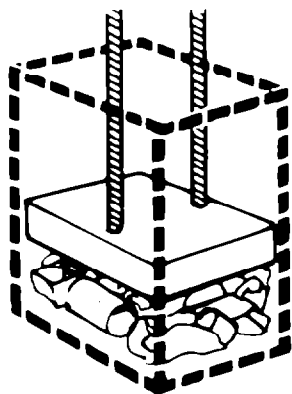

The trash in a full compactor bag will be about  $\frac{1}{4}$  the size of its original bulk.

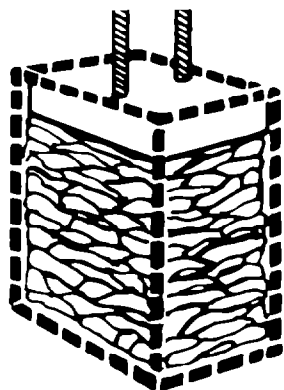

Bottles or cans not placed in the centre may become caught between the ram and the drawer. The Drawer Monitor Switch senses a "misload" and causes the ram to return to the "up" position without compacting. Load bulky trash, bottles and cans in the **centre** of the drawer.

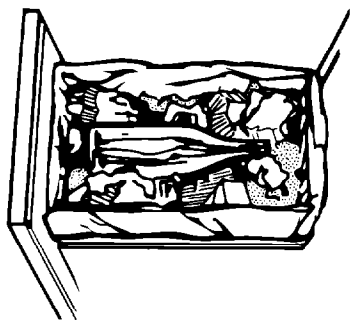

# Caring For Your Compactor

As is true of most appliances, proper care is needed to give you continued satisfaction. Before cleaning the compactor, turn the Key-knob to the OFF position and remove. If you will be away for more than a couple of days, remove the compactor bag. Lock the compactor and remove the Key-knob. Store the Key-knob in a safe place.

## Clean exterior surfaces:

1. Wipe with warm, soapy water and a damp cloth. Rinse. Dry with a soft cloth.
2. Wipe up spills right away. Some foods can damage the finish if left on the compactor surface.

**IMPORTANT:** Wear protective gloves when cleaning the inside of compactor in order to avoid cuts.

## Clean inside the drawer:

1. Remove the bag. (See "Removing a filled bag" on page 10.)
2. Wear protective gloves. There may be bits of glass in the drawer.
3. Press Side-lock latch down.

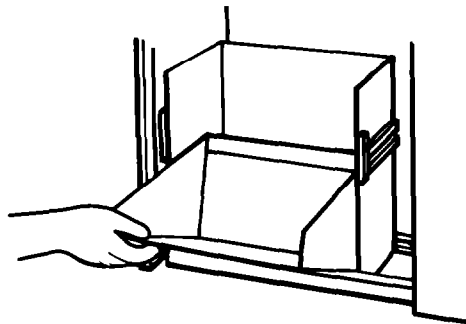
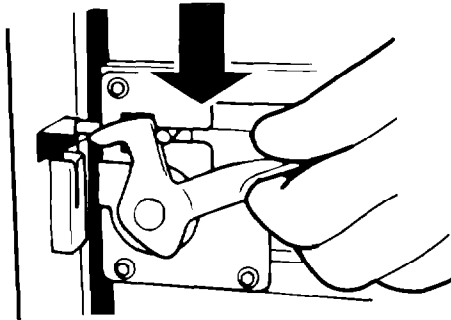

4. Hold Side-lock latch and tilt side of drawer until the latch clears the drawer front.  
**NOTE:** Drawer side can be removed by tilting it out, then lifting out.
5. If drawer contains bits of glass, use vacuum to remove.
6. Wash with a damp cloth using warm, soapy water. Rinse. Dry with a soft cloth.
7. If drawer side was removed, slide it back into the tilted position.
8. Press the Side-lock latch down while pressing the side to the upright position.
9. Lock the Side-lock latch.

## Caring For Your Compactor Continued

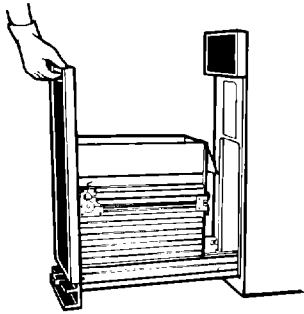

### Clean inside the cabinet:

Wear protective gloves. There may be bits of glass in the cabinet.

Pull the drawer out until it stops.

Note the tracks in which the drawer rollers move.

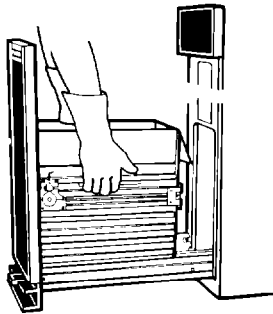

Lift the front to clear the drawer stops.

Grasp the drawer on the sides.

Pull it out the rest of the way.

Set it down gently.

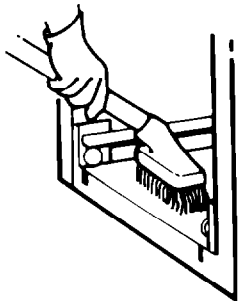

Vacuum inside of cabinet and ram cover. Liquid spills or wet trash should be cleaned up by hand, or use a vacuum designed to pick up liquids.

Wash, rinse, and dry inside.

Replace drawer.

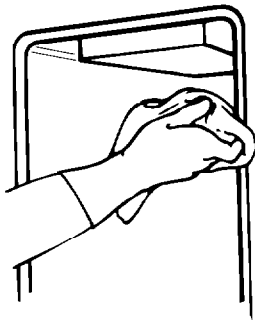

### Wipe off the ram cover:

Wear protective gloves. There may be bits of glass on the ram cover.

Wipe glass particles off ram cover with a cloth or paper towels.

Use warm, soapy water to remove foods. Rinse. Dry with a soft cloth.

# Changing Your Compactor's Colour

The colour panel on the front of your compactor's drawer reverses to another colour.

To change the colour of your compactor's front panel, follow the directions below. All you need is a medium-sized screwdriver.

1. Slide drawer out.
2. Remove two screws shown.
3. Remove handle.

**IMPORTANT:** When you are changing front panels, handle carefully to avoid cuts.

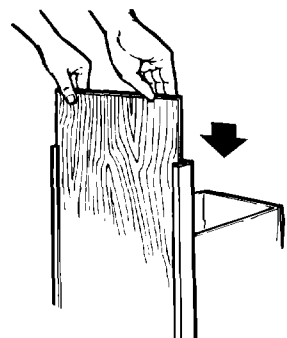
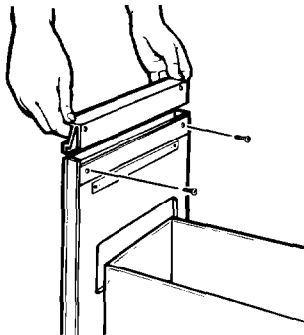
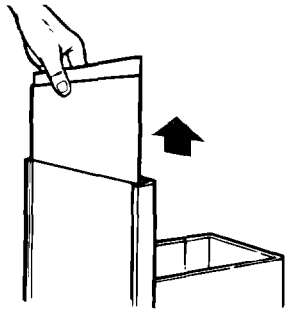
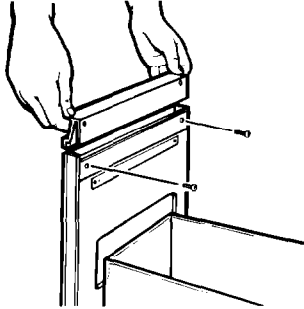

4. Remove the colour panel and reverse. Be careful – edges may be sharp.

**OR**

Place extra panel at front with desired colour showing.

5. Make sure panel(s) are all the way down.
6. Be sure to replace cardboard spacer in its former position.

7. Replace handle and screws.
8. Slide drawer back in.

**OPTION:** Match your kitchen's colour scheme by applying paint, wallpaper, or other material to the colour panel.

**OR**

Install a custom-made flat or raised panel in place of the colour panel(s) and spacer. A panel 5.6 mm thick is required. Decorative trim or raised panel sections must be 8 mm from all edges of outer section.



# Troubleshooting Guide/Service

Before calling for assistance ...

Performance problems often result from little things you can find and fix yourself without tools of any kind.

**If your compactor won't operate:**

- \* Is the power cable plugged into a live circuit with the proper voltage?
- \* Have you checked your home's main fuses or circuit breaker box?
- \* Is the drawer completely closed?
- \* Is the Key-knob turned all the way to START before it is released?

**Drawer won't open:**

- \* Drawer will open only when ram is all the way up.
- \* To raise the ram, turn the Key-knob to START and release.

**If trash is not compacting:**

- \* Is the drawer loaded properly? If anything gets between the ram and the drawer, the ram will return to the "up" position, without compacting.
- Drawer must be at least 1/3 full before compactor will compact.

**Not enough compaction or force:**

- Compacting works best when only a few items are loaded. Use the compacting cycle frequently.

**Bottles don't break:**

- Not all bottles will break every time, depending on the bottle and the trash load below it.

## WHIRLPOOL Compactor Warranty

CP004

LENGTH OF WARRANTY	WHIRLPOOL WILL PAY FOR
<b>FULL ONE-YEAR WARRANTY FROM DATE OF PURCHASE</b>	Replacement parts and repair labor to correct defects in materials or workmanship. Service must be provided by an authorized Whirlpool service company.
<b>WHIRLPOOL WILL NOT PAY FOR</b>	
<p><b>A.</b> Service calls to:</p> <ol style="list-style-type: none"> <li>1. Correct the installation of the compactor.</li> <li>2. Instruct you how to use the compactor.</li> <li>3. Replace house fuses or correct house wiring.</li> </ol> <p><b>B.</b> Repairs when compactor is used in other than normal, single-family household use.</p> <p><b>C.</b> Pick up and delivery. This product is designed to be repaired in the home.</p> <p><b>D.</b> Damage to compactor caused by accident, misuse, fire, flood, acts of God or use of products not approved by Whirlpool.</p> <p><b>E.</b> Repairs to parts or systems caused by unauthorized modifications made to the appliance.</p>	

7/96

**WHIRLPOOL CORPORATION SHALL NOT BE LIABLE FOR INCIDENTAL OR CONSEQUENTIAL DAMAGES.**

Whirlpool is a registered trademark of Whirlpool, U.S.A.  
Whirlpool ist ein eingetragenes Warenzeichen der Whirlpool, USA.  
Whirlpool est une marque déposée de Whirlpool, USA.  
Whirlpool is een geregistreerd handelmerk van Whirlpool, USA.  
Whirlpool è un marchio commerciale registrato della Whirlpool, USA.