

E·V·O·L·U·T·I·O·N



Operators Manual

Covers Instant, Freshbrew
& Espresso (B2C) Machines

Contents

	Page No.
Introduction	2
Important Safeguards	2
Section 1 - Machine Specifications.....	3
Section 2 - Installation Procedure	7
Section 3 - How To Vend A Drink	14
Section 4 - Daily Cleaning and Re-filling.....	20
Section 5 - Service Keypad Functions	32
Section 6 - Programming Mode	36
Section 7 - Operators Program.....	40
Section 8 - Dispense Pipe Lengths	62
Section 9 - Error Messages and Simple Problem Solving	69
Section 10 - De-commissioning The Machine.....	71

The following Symbol is used throughout this Operators Manual:



Safety First! Take care, risk of personal injury.

Introduction

This manual provides a guide to the installation, daily operation, basic cleaning and maintenance tasks for the **Evolution** range of freestanding vending machines and indicates when the operator should call a qualified service engineer for assistance. It is recommended that this equipment is serviced by a trained Service Technician.

It is the policy of Crane Merchandising Systems to continue developing its range of equipment. The information presented within this document was correct at time of publication, is for information only and may be changed without prior notice.

Important Safeguards

When using or cleaning the machine, always have this manual available for quick and easy reference and always follow these basic safety precautions:

1. Read all instructions before using the machine and ensure that anyone who will be involved with the cleaning or refilling of the machine also reads the instructions.
2. **Beware of Electricity:** Certain operations during the cleaning and maintenance procedure require the machine to be connected to the electricity supply and switched on. These routines must be carried out separately to all other operations and only by trained personnel. Observation of safe working practices in accordance with current regulations is necessary at all times.



Important! Unless specified, always disconnect the machine from the electricity supply before cleaning and servicing.

3. The mains lead should never trail from the machine and should always be kept away from hot surfaces and sharp edges.
4. Do not operate the machine if any part is damaged, e.g. mains lead, until it has been checked by a qualified Service Technician.
5. Allow the machine to cool before handling or moving.
6. Never immerse the machine in water, or any other liquid and never clean it with a water jet.
7. If the machine should accidentally freeze up, call a Service Technician to check it before switching on.
8. Ensure that you are conversant with the most recent Health and Safety at Work and Electricity at Work Regulations.

This machine is for indoor use only and because it is a beverage machine, should be sited in a clean, hygienic area.

Section 1 - Machine Specifications

1.1 Specifications

Height1830 mm

Width660 mm

Depth740 mm

Weight184 kg

Cup Capacity . . .600

Electrical Services

Voltage220 - 240 Volts AC

Current13 Amp Fused

Frequency50 Hz

Water Services

Pressure200 Kpa (2 Bar) - 600 Kpa (6 Bar)

Stopcock15 mm BSP from rising main

All weights and dimensions are approximate and are for guidance only.



1.2 Water Filter

Evolution machines fitted with a paperless freshbrew brewer or **CoEx®** espresso brewer must be connected to the water supply via a scale inhibiting water filter. Crane Merchandising Systems recommend and supply the Brita AquaQuell water filter.

1.3 External Features

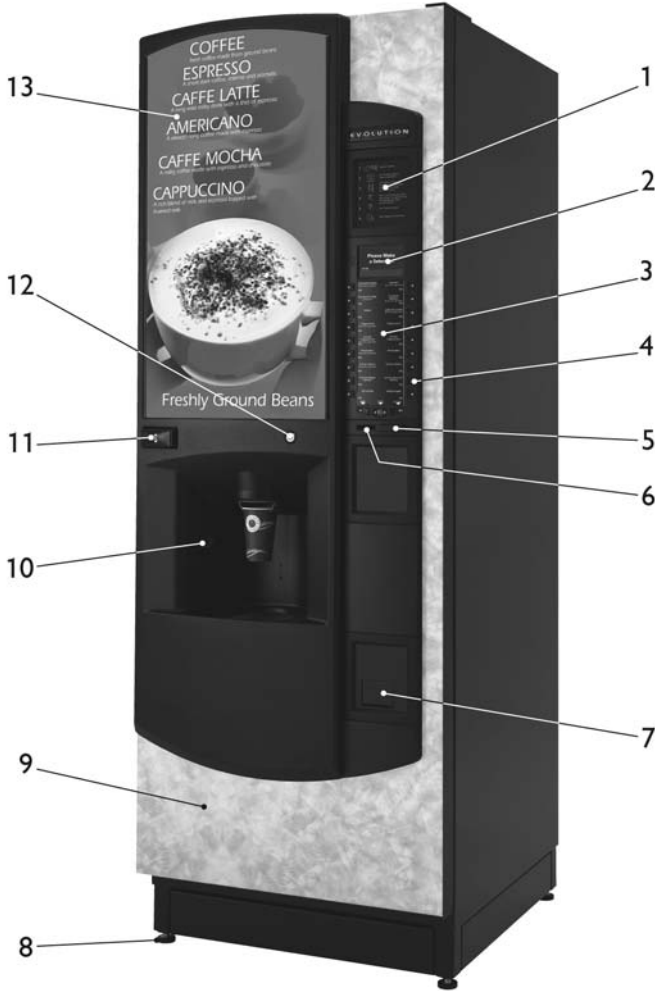

Key:

- | | |
|-------------------------------------|--------------------------|
| 1. Instruction Decal | 8. Foot |
| 2. LCD Display | 9. Door |
| 3. Selection Decals (Build A Drink) | 10. SureVend™ Sensor |
| 4. Drink Selection Keypad | 11. Door Lock |
| 5. Coin Reject Button | 12. Jug/Free Vend Switch |
| 6. Coin Entry | 13. Graphic Panel |
| 7. Coin Return | |

1.4 Internal Features

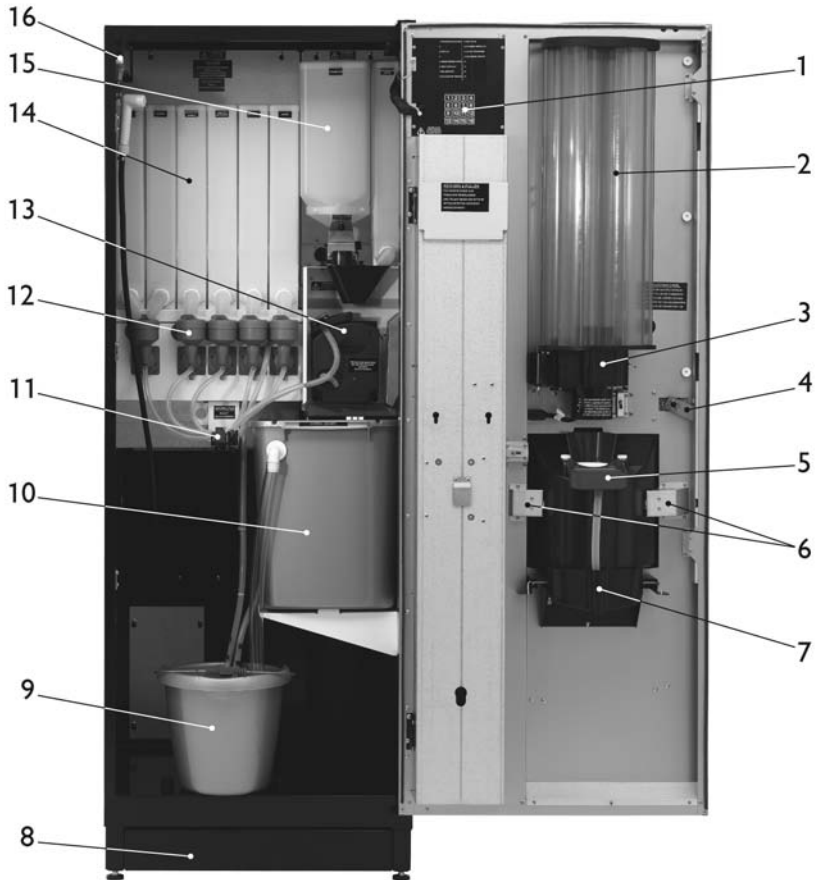

Key:

- | | |
|---------------------------|--------------------------------|
| 1. Service Keypad | 10. Brewer Waste Container |
| 2. Cup Turret | 11. Dispense Head |
| 3. Cup Drop Unit | 12. Mixing Station |
| 4. Door Locking Mechanism | 13. CoEx® Brewer (B2C) |
| 5. Cup Catcher | 14. Ingredient Canister |
| 6. SureVend™ Sensors | 15. Fresh Beans Canister (B2C) |
| 7. Drip Tray | 16. Door Switch |
| 8. Kickplate | |
| 9. Waste Bucket | |

Section 2 - Installation Procedure



Important! It is essential that personnel responsible for installing, commissioning and servicing the machine understand the following:

1. The installation and commissioning of the machine should only be carried out by trained and authorised service engineers.
2. All water and electrical services must be correctly and safely connected.
3. All covers must be replaced correctly and securely and the machine left in a safe condition.

2.1 Locating the Machine

1. The machine is suitable for indoor use only, situated in an area with a recommended ambient temperature not below 10° C and not exceeding 30° C. The machine should be located near the appropriate water and electrical services as detailed in **Specifications** (page 3).
2. Prior to moving the machine to its location, ensure that there is sufficient access space available via passageways, stairs, lifts, etc.
3. To ensure adequate ventilation, 100 - 150 mm (4 - 6 inches) clearance must be allowed between the back of the cabinet and the wall.
4. Open the door using the key provided. Remove all transit packing, installation kit and the box containing the cup stack assembly from the machine. Check for visual signs of damage which may have occurred during transit. If the machine is damaged or any parts are missing, you must contact the supplier immediately.
5. Using a 12 mm spanner, adjust the feet until the machine is levelled in both front to back and side to side planes. Ensure that the door opens and closes easily.

2.2 Connecting the Water Supply

1. The machine should be situated within 1 metre of a drinking water supply from a rising main, terminating with a W.R.C. approved 15mm compression stop-tap.

N.B. The water supply should comply with both the Statutory Instrument No.1147 - "Water, England and Wales" and The Water Supply (Water Quality) Regulations 1989. Water pressure at the stop-tap must be within the limits 2 - 6 Bar (200 Kpa - 600 Kpa).

2. **Freshbrew & Espresso Machines:** Evolution machines fitted with a paperless freshbrew brewer or CoEx® brewer must be connected to the water supply via a water filter. This filter must be of food grade quality and able to remove temporary hardness (scale), heavy metals (lead, copper, iron, cadmium), chlorine and any organic pollutant's/discolouration. Crane Merchandising Systems recommend and supply the **Brita AquaQuell** water filter. 



Warning! If the machines indicated above are connected to the water supply and used without a water filter as specified, the warranty will be void.

3. Connect the flexi-hose supplied with the machine to the stopcock ensuring that the seal supplied is fitted correctly. Flush the system (several gallons) before connecting the machine.
3. Connect the hose to the inlet valve located on the rear of the machine. Ensure that the seal is correctly fitted. Ensure that all water supply fittings are tight.
4. Turn on the water supply at the stop tap and check for leaks. Prime the water filter (where fitted) following the instructions supplied by the filter manufacturer.

2.3 Connecting the Electrical Supply



Safety First! The machine **must** be earthed. On no account should it be earthed **only** to the water supply pipe.

The machine must be connected to a 230 Volt 50Hz 13 amp fused switched socket outlet, installed to the latest edition of the IEE regulations, using a 3 pin BS approved 13 amp fused plug.

Important: If the mains lead becomes damaged in any way it must be replaced by a special lead available from the manufacturer.

2.4 Commissioning Procedure

The following procedure must be carried out by a trained installation engineer before the machine can be used for the first time. Ensure that the electrical and water services to the machine are connected correctly. Check for leaks in the water supply.

1. Open the front door of the machine. Fit the door switch bracket to the door using the two screws provided. Ensure that the bracket will operate the door switch when the door is closed. Switch on the electricity supply.
2. Ensure that the waste bucket is fitted correctly. Clip the level detector and overflow pipes correctly onto the rim of the bucket.

3. **Cup Turret.** Release the catch securing the cup drop unit and swing the unit away from the door. Remove the cup stack assembly from its packaging and carefully place it onto the cup drop unit. Ensure that the flat on the turret drive shaft locates with the flat in the cup turret mounting block. Remove the lid and fill the tubes with the correct size cups for the type of cup catcher fitted to the machine. Allow the cups to drop into the tubes directly from the packaging. **DO NOT** touch the cups with your hands.



Important: Do not fill the tube directly above the cup dispense position. Allow the cup turret motor to rotate a full tube to the cup dispense position when the machine is powered up. Rotating the cup turret by hand will damage the mechanism.

Note: If paper cups are being loaded, each pack of cups must first be inspected for damage to the cup rims. Damaged cups must not be used.

4. Insert the safety key (a) supplied with the machine into the door switch as shown. The machine is now on. The cup turret mechanism will index the first available full cup stack to the dispense position and drop the cup stack into the cup drop mechanism. Fill the remaining empty cup stack with cups and replace the lid.

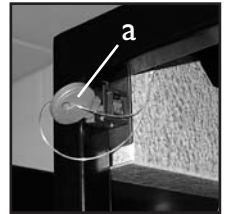

5. Swing the cup turret assembly back to its operating position. Ensure that the unit is held securely by the catch.

6. **All Models:** The water inlet valve will open and the heater tank will start to fill. As the water heats, ensure that no water overflows from the heater tank overflow pipe into the waste bucket. When the machine has powered up, the LCD will display the message as shown opposite. Check the system for leaks.

**Sorry Out of Service
Water Tank
Heating**

Note! The machine has a safety cut-out which will only allow the heater tank to fill for a maximum of two minutes. If after software power-up the heater tank has not filled within this time, the mains power supply should be switched off and then on again to reset the heater tank time-out.

Espresso Models: As the machine initialises a small amount of water is pumped through the system and is discharged into the waste bucket. When the machine enters standby mode remove the bucket and empty the contents before refitting to the machine.

N.B. Before using the espresso machine for the first time it is necessary to purge the water system to ensure any water left in the system during transport is dispensed. Press button 9 on the Service Keypad fitted inside the door (photo). The machine will pump approximately 400ml of water through the system which will be heated to operating temperature before being discharged into the waste bucket. When the machine enters standby mode remove the bucket and empty the contents before refitting to the machine.



Important: Should the machine fail to fill correctly or leak, turn off the stopcock and the power to the machine before investigating the fault.

7. Check the LCD display on the front of the machine to ensure that the water has heated to the correct temperature and that the machine is in standby mode. A machine set to free vend mode will alternate the messages:

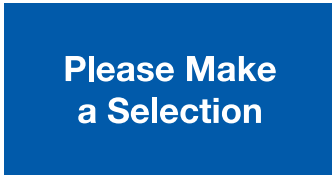

N.B. Messages displayed in standby mode will change depending upon the monetary device fitted and set up during programming.

8. **All Models:** Rotate soluble/freshbrew ingredient canister outlets to upright position.

Remove the milk canister from the machine and remove the lid. Place the canister into the canister filling station located on the door (photo) and fill canister with correct ingredient.

DO NOT place the canister on the floor or overfill with ingredient.

Carefully remove the canister from the filling station and replace the lid. Refit canister into machine ensuring that it is returned to correct operating station.



Repeat this operation for all soluble/freshbrew ingredient canisters fitted to the machine. Rotate the canister outlets to their correct operating positions.

9. **Espresso Models:** Close the outlet slide to seal the fresh beans canister outlet before removing the canister from the machine. Remove the canister lid.

To aid filling, hang the fresh beans canister on the rear of the door utilising the two keyhole slots provided. **DO NOT** place the canister on the floor.

Fill the canister with fresh coffee beans. The canister has a capacity of approximately 3.5 kgs. Refit the canister lid and carefully remove the canister from the door. Refit the canister into the machine, ensuring that it is located correctly. Open the outlet slide to ensure correct operation.



N.B. To maintain optimum drink quality, Crane Merchandising Systems recommend that the bean canister is replenished on a daily basis.

10. Press the **Cup Test** switch (7), located in the Service Keypad on the rear of the door and ensure that a cup is ejected cleanly from the cup drop unit.
11. Press the **Park Head** switch (8), located in the Service Keypad on the rear of the door and ensure that the dispense head moves to its fully extended position. Press the switch again to return the dispense head to its correct (homed) position.
12. **Freshbrew Models:** Ensure the brewer guard and brewer waste container are fitted correctly. Slide the container into position directly under the brewer with its lip outside the brewer cover.

(Freshbrew models fitted with paper fed brewer only - proceed with steps 13 - 15)

13. Load the filter paper roll (provided in the installation kit) onto the support.
14. Press and hold the **Brewer Open** switch (2) on the service keypad until the brewer chamber reaches its fully open position. Remove the safety key to switch off the power to the machine.
15. Remove the brewer cover and paper/waste ingredient guard. Feed the filter paper under the raised chamber and through the feed wheels.
Refit the guard and brewer cover. Insert the safety key into the door switch. The brewer will index to its closed position and stop.
16. **Espresso Models:** Ensure that the brewer waste container is fitted correctly beneath the CoEx® brewer unit and tea brewer unit (if fitted).

- Referring to Sections 6 & 7 of this manual, **Programming Mode** and **Operators Program**, use the menu selections available to programme the required settings for correct machine operation e.g. drink prices, disable selections, time and date etc.
- If fitted, check that the coin mechanism and cash box operate correctly. Release the catch securing the coin mechanism cover (photo) and swing the cover away from the door. Fill the coin tubes with correct coinage. Ensure coin return mechanism functions correctly.
- Operate the machine through its complete range of selections to ensure that each vend is correctly dispensed. Follow the instructions detailed on page 34 for making a vend using the **Test Vend** switch (6) located on the Service Keypad.
- Remove the safety key and close the cabinet door. Ensure that the machine is left in a clean and safe condition.



2.5 Setting Up The Carbonator Unit - Where Fitted

- Open the cabinet door. Fit the seal (1), provided in the installation kit, to the regulator as shown in the photograph. Connect the regulator to the gas bottle.
- Tighten the locknut. Carefully lift the cylinder into the machine ensuring that the gas supply pipe is not trapped or obstructed in any way.

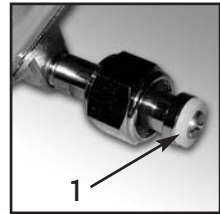

Safety First! The cylinder may be heavy. Always follow the correct procedure when lifting heavy objects.

- Secure the gas bottle with the safety chain. Turn on the gas supply from the bottle and ensure that the regulator (2) is indicating a gas pressure of 35 PSI.
- Place the carbonator overflow pipe into the waste bucket. Fill the carbonator water bath with clean cold water until it starts to run from the overflow pipe.



- Re-fit carbonator covers and empty the waste bucket. Switch on the carbonator unit using the carbonator switch located on the power supply.
- Place the syrup containers in the bottom right-hand side of the cabinet and insert the dip tubes into the containers ensuring that the correct flavours correspond

to the drinks displayed on the selection decals.

6. Prime the syrup selections ready for use. Insert the safety key into the door switch. The machine is now ON. When the machine enters standby mode, press button 13 on the service keypad. The LCD will display the screen opposite.

Pumps	
1	2
Press and Hold Number	

N.B. Ensure that the waste bucket is empty and in place before priming the pumps.

7. To prime syrup pump 1, press and hold button 1 on the drink selection keypad until the syrup appears from the dispense head. Repeat for syrup pump 2 by pressing and holding button 2 on the drink selection keypad. Press the **X** (Exit) key to return the machine to standby mode. Empty the waste bucket and refit to the machine.
8. Test vend the carbonated drinks to ensure correct operation of carbonator unit. Check for leaks and ensure that the machine is left in a clean and safe condition. Remove the safety key and close the door. The machine reverts to standby mode.

N.B. If a still unit is fitted ensure that the ingredient timers for syrup drink 1 and 2 are set to 6 seconds (recommended).

Section 3 - How To Vend A Drink

Evolution machines are available with either a numeric keypad or an intuitive build a drink interface. Both selection methods allow the user to produce a drink to their preferred taste and strength.

3.1 Selecting A Drink - Numeric Keypad

1. Drink selections are made by pressing the appropriate numbered buttons on the keypad which relate to the selections displayed on the drinks menu panel.

2. As an example, in order to obtain a fresh coffee selection made from fresh ground beans with extra sugar and extra white from an espresso machine set to 'Free Vend', the customer presses button 9 followed by button 4 on the keypad. The LCD will display the number selected.



Fresh Coffee			
Made from freshly ground beans			
	sugar	extra sugar	no sugar
White	90	91	92
Extra White	93	94	95
Black	96	97	98

3. The **Strong**, **Normal** and **Mild** buttons incorporated into the keypad allow further options to suit the customers personal preference.



N.B. If a strength option is not selected within five seconds of the drink selection, the machine will automatically vend a Normal strength selection.

4. Unless the customer has placed their own cup into the dispense area, a cup will automatically be ejected from the cup drop unit into the dispense area and the drink selection will be delivered into the cup. Whilst this operation is in progress the LCD will display the screen shown opposite.



3.2 Selecting A Drink - Build A Drink

Drink selections are made by pressing the appropriate selection button on the keypad and then utilising the keypad selection buttons and the LCD display to alter the drink strength and add milk/sugar to suit the customers personal preference. When in standby mode, all drink selection buttons will be lit indicating that the drink is available to be selected. At this time the Milk, Sugar and Start buttons are not lit.

The following example describes how to vend a Freshbrew Tea selection from a freshbrew machine set to 'Free Vend'.

1. Press selection button 3, **Freshbrew Tea** on the keypad. All of the other selections buttons will be extinguished, the Milk, Sugar and Start buttons will light up and the machine exits from standby mode. The LCD will display the screen as shown opposite.



N.B. The default strength setting for this drink selection is **Normal** as shown.

2. To obtain a **Strong** or **Mild** beverage it is necessary to press the current drink selection button. Pressing once will toggle to the Strong selection. Pressing the button again will toggle to the **Mild** selection.



Pressing the current drink selection button again will revert to the Normal screen.

3. If milk and/or sugar is required, it is necessary to press the corresponding button on the keypad for each selection. When the Milk button is pressed the LCD changes and displays the default screen as shown opposite.

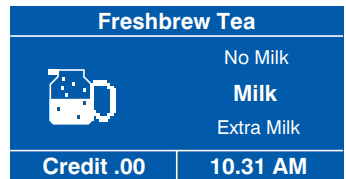

4. If **Extra Milk** is required the customer presses the milk button a second time. A third press will display the **No Milk** selection.

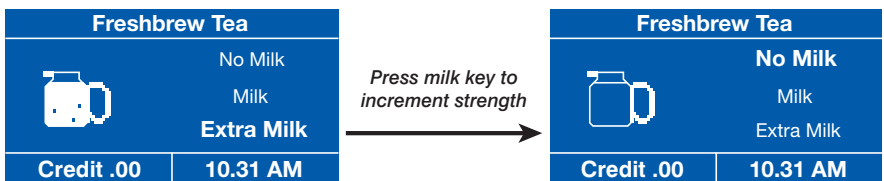

Pressing the milk button again will revert to the Milk selection.

5. If the customer requires sugar it is necessary to press the sugar button. The LCD changes and displays the default screen shown opposite.

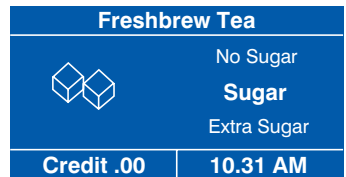

6. If **Extra Sugar** is required the customer presses the sugar button a second time. A third press will display the **No Sugar** selection.

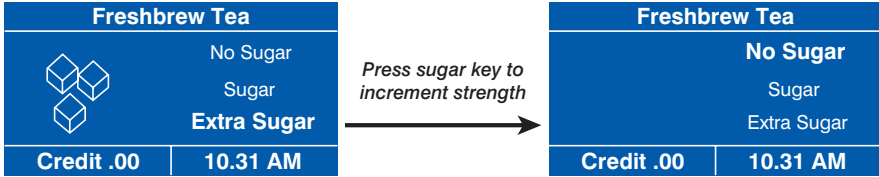

Pressing the sugar button again will revert to the Sugar selection.

7. Once the required drink has been selected, press the Start button on the keypad. All lit buttons will be extinguished apart from the drink selection button which flashes indicating that the drink is being vended.

Unless the customer has placed their own cup into the dispense area, a cup will automatically be ejected from the cup drop unit into the dispense area and the drink selection will be delivered into the cup. Whilst this operation is in progress the LCD will display the screen shown opposite.

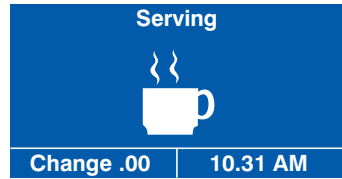

8. After the beverage has been dispensed the LCD will display the message **Thank You** and the machine will beep once. The message on the display will change to read **Please remove cup**. The drink can then be carefully removed from the dispense area and the machine will return to standby mode.

9. Certain drink selections do not allow the strength option to be selected or milk added. For example, if the customer presses the **Cappuccino** selection button, all of the other selection buttons will be extinguished, the Sugar and START buttons will light up and the LCD will display the screen opposite. The customer can either press the START button to vend the drink or first press the sugar button in order to add sugar to their taste as described above.



10. Other drink choices do not allow the strength option or milk/sugar to be selected. For example, if the customer presses the **Chocolate** selection button, all of the other selection buttons will be extinguished, the START buttons will light up and the LCD will display the screen opposite. The customer simply presses the START button and the machine will vend the drink as described above.

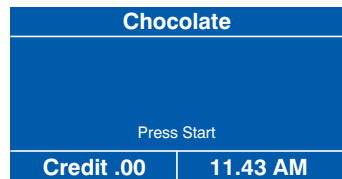

3.3 Selecting A Drink - Cold Drink Selections

Evolution machines may be fitted with either a chiller or carbonator unit allowing cold water and flavoured drinks to be vended, either still or both still and sparkling.

The following example describes how to vend a cold flavoured drink from an Evolution machine fitted with a carbonator unit.

1. Press the selection button for the cold flavoured drink required on the keypad. All of the other drink selection buttons will be extinguished, the START button will light up and the machine exits from standby mode. The LCD will display the screen as shown opposite.

Cold Drink 1 (Still)	
(Press Start)	
Credit 0.00	01.50

N.B. The default setting for cold drink selections is Still as shown.

2. To obtain a Sparkling drink press the current drink selection button. Pressing the button again will revert back to the Still setting.
3. Once the drink has been selected, press the START button on the keypad. The drink selection button will flash indicating that the drink is being vended. Unless the customer has placed their own cup into the dispense area, a cup will automatically be ejected from the cup drop unit into the dispense area and the drink selection will be delivered into the cup. Whilst this operation is in progress the LCD will display the “Serving” screen
4. After the cold drink has been dispensed the LCD will display the message Thank You and the machine will beep once. The message on the display will change to read Please remove cup. The drink can then be removed from the dispense area and the machine will return to standby mode.

3.4 Replacing/Updating Drink Selection Decals

1. Numeric Keypad Models

Self adhesive drink selection and pricing decals are mounted onto the main graphic panel which is secured behind a removable transparent cover. To update drink pricing or replace drink description decals, proceed as follows:

1. Open the front door of the machine. Supporting the transparent graphic cover with your right hand, carefully undo and remove the three knurled thumb screws from the rear of the door which secure the graphic cover support strip.
2. Carefully remove the support strip, graphic cover and printed graphic from the machine. Place the graphic face-up on a clean, flat surface.

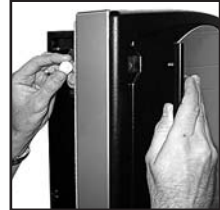

3. **Updating drink pricing:** Carefully remove the previous price decals from the drink selection decals. Update the prices where necessary using new self adhesive decals. These are available as spares from the manufacturer.
4. **Updating drink selections and pricing:** When updating selection decals and prices it may be necessary to use a new graphic panel. These are available as spares from the manufacturer.

Peel the relevant drink selection decals from their backing sheet and apply to the graphic panel using the printed guides as shown (photo).

Important: Ensure that drink selections and numbering used relate to drink choices programmed into the machine software.

Apply price decals as described above.



5. Refit the printed graphic, transparent cover and graphic support strip to the door. Ensure that the transparent cover is correctly located in the fixed support strip before securing the removable support strip with the three knurled thumb screws.
6. Close the front door and ensure that the machine returns to standby mode.

2. Build A Drink Models

Self adhesive drink selection and pricing decals are mounted onto a paper backing sheet which is secured behind a transparent clip-in cover. To update drink pricing or replace drink description decals, proceed as follows:

1. Open the front door of the machine. Release the catch securing the coin mechanism cover and swing the cover to its open position.
2. Carefully remove the main controller board cover. Loosen the two screws above the keyhole slots which secure the cover and lift the cover out of the machine.

3. Referring to the photograph, carefully press down the snap fit clip (a) to release the transparent decal cover.

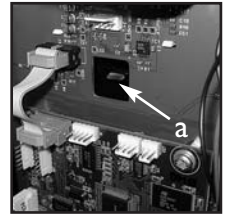

Remove the transparent cover and decal sheet from the door moulding. Place the decal sheet face-up on a clean, flat surface.

4. **Updating pricing:** Carefully remove the previous price decals from the drink selection decals. Update the prices where necessary using new self adhesive decals. These are available as spares from the manufacturer.
5. **Updating drink selections and pricing:** When updating selection decals and prices it will be necessary to use a new backing sheet. These are available as spares from the manufacturer.

Peel the relevant drink selection decals from their backing sheet (part no. PR10233000 & PR10918000) and apply to the backing sheet using the printed guides as shown opposite.

Important: Ensure that drink selections used relate to drink choices programmed into the machine software.

Apply price decals as described above.

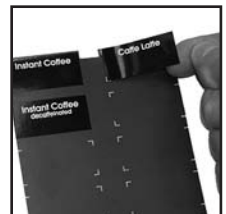

6. Place the decal carrier behind the transparent decal cover and refit complete assembly to the door. Ensure decal cover locating lugs are correctly located before pushing the snap fit clip into place.
7. Replace the main controller board cover and tighten the screws to secure. Close the coin mechanism cover ensuring that the catch is secured correctly. Close the front door and ensure that the machine returns to standby mode.

Section 4 - Daily Cleaning And Re-filling

The quality of drinks produced by the Evolution can only be maintained if the machine is cleaned regularly following the schedule outlined. Before carrying out the daily cleaning procedure described on the following pages, it is recommended that you have the following materials to hand:

- Bactericidal Cleaner
- De-Staining Agent
- Cleaning Cloths
- Paper Towels
- Small Brush
- Two Large Buckets
- Disposable Gloves
- CoEx® Cleaning Tablets (Espresso Machines)

4.1 Bactericidal Cleaner

This can either be a liquid or powder agent which should be dissolved in clean water in accordance with the instructions on the product packaging. The solution should be used for cleaning machine components and wiping surfaces during the cleaning operation.

4.2 De-Staining Agent

This is a liquid or powder agent which should be dissolved in clean water in accordance with the instructions on the product packaging. The solution can be used on heavily soiled or stained components such as buckets and drip trays. Items or surfaces cleaned with this solution must be rinsed in clean water to remove traces of the cleaning agent.

4.3 Liquid Destainer - Brewer Units

Crane Merchandising Systems recommends that a liquid destaining product is used for cleaning the paper/paperless brewer units fitted to Evolution freshbrew machines. The product must be used in accordance with the instructions on the product packaging, following all health and safety guidelines. A detailed procedure for cleaning the brewer units is outlined on pages 25 - 28 of this Operators Manual.

4.4 Cleaning Tablets - CoEx® Brewer Units (Espresso Models)

Crane Merchandising Systems recommends that the brewer cleaning tablets supplied with the machine are used exclusively for cleaning the CoEx® brewer fitted to Evolution espresso machines. These are available from your machine supplier in packs of 30 - part number ZC10598000. A detailed procedure for cleaning the CoEx® brewer unit is outlined on pages 28 - 30 of this Operators Manual.

Important: It is necessary to carry out the cleaning and maintenance procedure outlined on the following pages on a regular basis, either at the end of the day or at the start of the day before the machine is in constant use.

4.5 Cleaning & Filling Procedure - All Machines

1. Fill a cleaning bucket with hot water and dilute the bactericidal cleaner in accordance with the instructions on the product packaging. Open the door of the machine.

2. Rotate canister outlets to upright position. Remove the ingredient canisters. **DO NOT** place them on the floor.

With a clean, damp sanitised cloth, remove any ingredient build up on the exterior of the canisters, paying particular attention to the area around the canister outlets. Ensure canister outlets are dried thoroughly after cleaning.



3. Twist and remove mixing bowls and steam hoods (a). Remove the dispense pipes (b) from the plastic dispense block.

Remove the knurled nut securing the plastic dispense block. Remove the dispense block and clean thoroughly in the diluted bactericidal cleaner solution.

Rinse the dispense block with clean water and dry thoroughly before refitting to the machine.

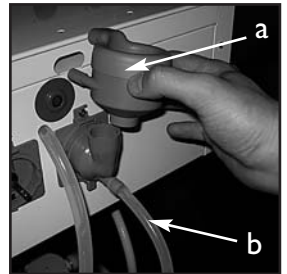

4. Remove the extract tray from the machine. Using a dry brush clean the area under the extract tray.

Clean the extract tray. Dry and refit to the machine.

Wipe the canister shelf and the upper interior of the machine with a clean, damp sanitised cloth.



- Twist the whipper base (a) anti-clockwise until it releases. Remove mixer units (b) and impeller (c). Pull the whipper base off of the shaft.

Clean all of the mixing system parts, including the steam hoods, mixing bowls and dispense pipes thoroughly in the diluted bactericidal cleaner solution. Rinse all components with clean water and dry thoroughly before refitting to machine.

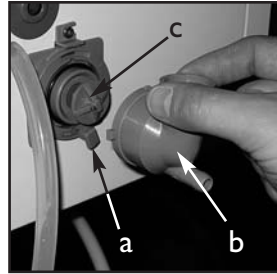

- Refit the whipper base. Push the whipper base onto the motor shaft with the 'arrow' symbol lined up with the motor plate fixing screw (d) as shown. Rotate the whipper base clockwise until it locates with the first locking position (e). Ensure 'O' ring (f) is correctly located as shown.

Refit the impellers to motor shafts ensuring that the 'flat' in the moulding lines up with the flat on the shaft.

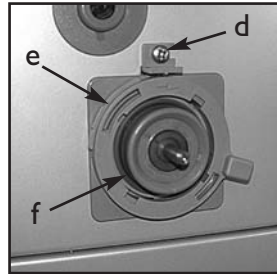

- Refit mixer unit to whipper base. Rotate the whipper base clockwise until it locks into place.

Refit steam hoods, mixing bowls and dispense pipes to mixer units. Refit the dispense pipes to the dispense block.

Important: Ensure pipes are refitted to their correct outlet position on the dispense block (see pages 64 - 70 for details).

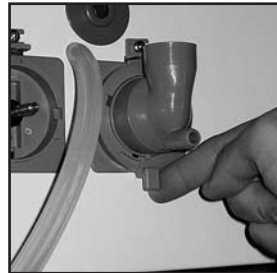

- Check the ingredient canisters and refill if required. Remove canister lid and place the canister into the canister filling station located on the door. Fill canister with correct ingredient.

Carefully remove the canister from the filling station and replace the lid. Refit canister into machine. Repeat this operation for all soluble/freshbrew ingredient canisters fitted to the machine. Rotate the canister outlets to their correct operating positions.

Important: Ensure that the canisters are refitted to correct operating stations.

Weekly: Empty and wash the ingredient canisters. Dry thoroughly, refill and refit into machine.



9. **Espresso Models:** If necessary refill the fresh coffee beans canister. Close the outlet slide (a) to seal the canister exit before removing the canister from the module.

Remove the canister lid. To aid filling, hang the canister on the rear of the door utilising the keyhole slots provided. **DO NOT** place the canister on the floor. Refill canister with fresh coffee beans.

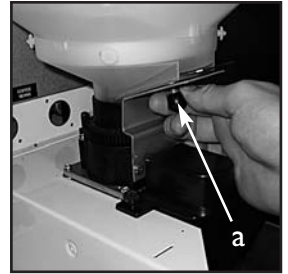

Refit the canister lid to the canister. Refit canister to the module. Ensure that the outlet slide is opened to ensure correct operation.

N.B. To maintain optimum drink quality, Crane Merchandising Systems recommend that the bean container is replenished on a daily basis.

10. Remove the waste water bucket from the machine. Empty and clean.

If fitted, check the syrup levels in the syrup containers and replace if necessary.

Clean the base, sides and back of the machine.

Refit the waste water bucket into the machine. Ensure that the level detector and overflow pipes are located correctly in the bucket.



11. Undo the knurled nuts and remove the cup throat moulding complete with drain pipe.

Clean cup throat and pipe in the sanitiser solution. Rinse both components with clean water and dry thoroughly.

Reassemble to the machine.



12. Pull out the two spring loaded pins (a) securing the drip tray and turn to lock as shown. Pull and remove the complete drip tray assembly out of its mounting bracket.

Wash the tray and grille thoroughly and where necessary, sanitise using the diluted bactericidal cleaner solution.

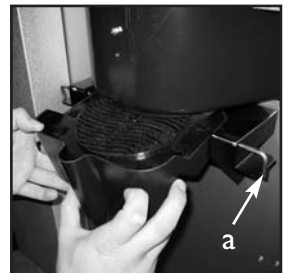

13. Wipe clean the interior of the door and the area around the cup station using a clean, damp sanitised cloth.

Refit the drip tray ensuring that the drip tube from the cup throat moulding is located correctly at the rear of the tray.



14. Check the levels of the cups in the cup turret and where necessary, refill with correct sized cups.

Release the catch (a) securing the cup drop unit and swing the unit away from the door. Remove the lid and fill the tubes with the correct size cups for the type of cup catcher fitted to the machine.

Allow the cups to drop into the tubes directly from the packaging. **DO NOT** touch the cups with your hands.



Important: Do not fill the tube directly above the cup dispense position. Allow the cup turret motor to rotate a full tube to the cup dispense position when the machine is powered up. Rotating the cup turret by hand will damage the mechanism.

Note: If paper cups are being loaded, each pack of cups must first be inspected for damage to the cup rims. Damaged cups must not be used.

Replace the lid and rotate the cup turret assembly back to its operating position. Ensure that the unit 'locks' into place.

15. Release the catch and open the coin mechanism cover. Wipe the inside with a damp cloth.

Un-lock the cashbox (if fitted) located on the rear of the door and remove from the machine as shown. Remove any coinage from the cashbox. Refit the cashbox to the machine, turning the lock to secure.

Check the coin tubes and refill if required.



16. Insert the safety key supplied with the machine into the door switch. The machine is now on.

Using the service keypad located in the rear of the door (photo), proceed as follows:



- a. Press the Cup Test switch (7) and check that a cup is ejected correctly from the Cup drop unit.
- b. Press the Park Head switch (8) to ensure that the dispense head operates correctly and that the dispense pipes are fitted correctly.
- c. Place a suitable container under the dispense head and press the Rinse/Flush switch (3). The machine will flush the system. Check that all of the mixing stations are water tight. Empty the contents of the container.
- d. Place an empty cup under the dispense head. Press the Test Vend switch (6) and using the selection buttons on the front of the machine, vend a drink to ensure that the machine operates correctly. Press the 'X' (Exit) key to exit from the Test Vend menu.
- e. Press the View Counters switch (5) and record the audit information displayed on the LCD (see page 33 for full details).

Remove the safety key and close the door. Clean and buff the outside of the machine.

4.6 Paper Type (King) Freshbrew Brewer Cleaning Procedure

At least twice a week the paper type brewer unit must be removed from Evolution freshbrew machines and cleaned.



Safety First! Never clean or service the brewer unit while it is in motion as fingers may become trapped in the mechanism.

1. Open the front door of the machine and remove the paper/waste ingredient guard. Switch on the power using the door switch safety key.
2. Press and hold the Brewer Open switch (2) located in the service keypad on the rear of the door to index the brewer to its fully open position.

When the brewer reaches its fully open position, remove the safety key to switch off the power. Tear the filter paper above the brewer (a). Remove the used paper from the brewer unit.



3. Remove the brewer dispense pipe from the dispense head. Pull down the brewer release pin (b) and carefully lift the brewer unit up and clear of its locating bracket. Thoroughly clean the external surfaces of the brewer.
4. With the brewer unit removed, clean the area surrounding its locating bracket. Refit brewer to machine and refit the outlet pipe to the dispense head.

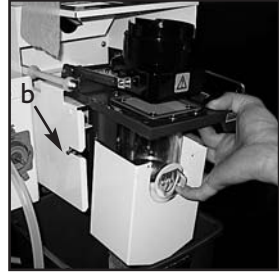

5. Switch on the power to the machine using the safety key. The brewer chamber will return to its closed position. Referring to the instructions supplied with the product, pour the recommended amount of de-staining fluid directly into the top of the brewer chamber. Flush the brewer using the Brewer Clean switch (4) following the procedure outlined on page 33.
6. Press and hold the Brewer Open switch (2) to index the brewer to its fully open position. Remove the safety key to switch off the power to the machine. Feed the filter paper through the paper feed mechanism. Switch on the power to the machine using the safety key. Filter paper will index automatically and the brewer chamber will return to its closed position. Refit the brewer guard.
7. Remove the brewer waste container and empty its contents. Clean waste bucket and refit into machine. Remove the safety key and close the door.

N.B. Every time that the brewer waste container is emptied the waste counter must be reset. Restore power to the machine using the safety key and press button 12 on the service keypad. Two audible bleeps confirm that the counter has been reset to zero.

4.7 Paperless Brewer Unit - Cleaning Procedure

1. Switch on the power using the door switch safety key. Press and hold the Brewer Open switch (2) located in the service keypad on the rear of the door until the brewer chamber reaches its fully open position.

Remove the door switch safety key to switch off the power to the machine. Remove the brewer guard.

2. Carefully remove the water outlet tubes c/w water pipes (a) from the tea and coffee chambers. Lift the latch bar (b) and remove the brewer chambers/wipe arms assembly.

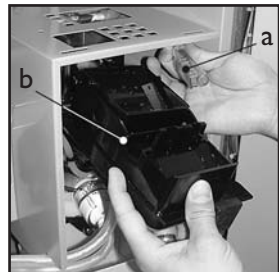

3. Clean the brewer chambers/wipe arms assembly in the sanitiser solution. Rinse with clean water and dry thoroughly.

4. Carefully slide the brewer chambers/wipe arms assembly into the brewer unit.

IMPORTANT: The wiper arm lug (a) must be located between the stainless steel arms (b) as shown.

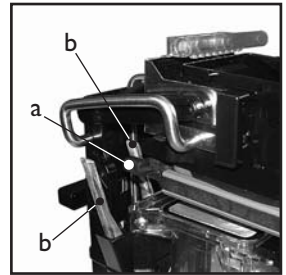

5. Re-assemble the water outlet tubes to the coffee and tea brewer chambers.

Using the clamp supplied, close the tea outlet tube as shown.

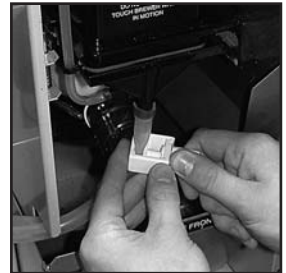

6. Switch on the power using the door switch safety key. The brewer chamber will automatically index to its closed position.

Ensure that a suitable container is placed under the dispense area.

Pour the recommended amount of destaining fluid directly into the top of both brewer chambers.



7. Remove the clamp from tea dispense pipe. Press the Brewer Clean switch (4) located in the service keypad on the rear of the door. The machine will automatically flush through the brewer four times.

If necessary repeat the above instruction until all traces of cleaning fluid are removed from the brewer chambers.

8. Remove the door switch safety key. Remove and empty the water waste container. Refit the brewer guard.

Remove the brewer waste container from the machine. Empty the contents. Wash the waste container thoroughly and where necessary sanitise using the sanitiser solution. Dry using a clean cloth and refit into the machine.

N.B. Every time that the brewer waste container is emptied the waste counter must be reset. Restore power to the machine using the safety key and press button 12 on the service keypad. Two audible bleeps confirm that the counter has been reset to zero.

Close and lock the door.

4.8 CoEx® Espresso Brewer Unit - Daily Cleaning Procedure

1. Remove the coffee dispense pipe from the brewer outlet. Holding the unit as shown in the photograph, lift the green lever (a) and carefully pull the brewer unit out of the machine.



Fill a cleaning bucket with hot water and dilute the bactericidal cleaning agent in accordance with the instructions on the product packaging.

2. Carefully place the CoEx® brewer unit into the diluted bactericidal solution and clean the unit thoroughly. Ensure all coffee ground deposits are removed, paying particular attention to the area around the top of the piston and waste chute.



Remove the unit from the solution and rinse thoroughly with clean water. Dry the unit using a clean cloth or paper towels.

3. Remove the espresso coffee chute assembly (a). Unscrew the two knurled thumbscrews (b) and remove the coffee chute and coffee chute cover.

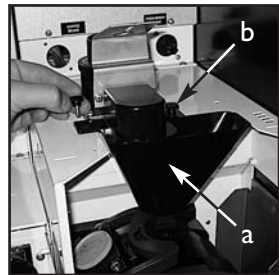

With a clean, dry brush clean the area around and under the coffee dispense outlets.

4. With a clean, dry brush wipe away any coffee deposits from both the coffee chute and cover mouldings.

Refit the coffee chute lid to the chute ensuring that the lugs on the cover fit securely into their mounting holes.

Refit the assembly to the machine and secure using the two knurled thumbscrews.

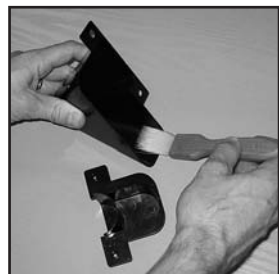

- Carefully remove the brewer waste container from the machine and empty the contents. Push up and remove the waste chute (a) from the machine.

Wash both the waste container and chute thoroughly and if necessary sanitise using the diluted bactericidal cleaning solution. Rinse in clean water.

Dry both components using a clean, dry cloth and refit to the machine.

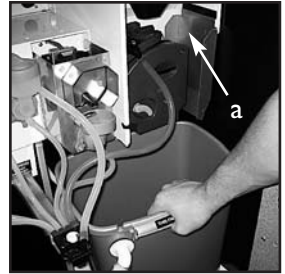

N.B. Every time that the brewer waste container is emptied the waste counter must be reset. Restore power to the machine using the safety key and press button 12 on the service keypad. Two audible beeps confirm that the counter has been reset to zero.

- Refit the CoEx® brewer unit into the machine. Slide the unit into place until it 'clicks' into position. Refit the coffee dispense pipe to the brewer outlet as shown.

Ensure that both the fresh bean container and fresh ground coffee canister are filled with correct product. Refill if necessary following the procedures outlined on pages 22 and 23.



4.9 CoEx® Espresso Brewer Unit - Weekly Cleaning Procedure

The following procedure must be carried out on a weekly basis. Proceed as follows:-

- Open the front door of the machine and insert the safety key to restore power to the machine.



Caution: Ensure that a suitable container is placed under the dispense position. Keep hands away from the dispense area whilst the cleaning cycle is in operation.

- Press and release button 11 on the service keypad. The LCD will display the message '**Please Place Cleaning Tablet in Brewer**'.

Take one cleaning tablet (supplied in packs of 30 - CMS part no. ZC10598000) and place it into the brewer piston chamber as shown.



3. Press the **START/?** key on the drink selection keypad to begin the CoEx® tablet cleaning routine.
4. The cleaning cycle lasts approximately 7 minutes and dispenses 850 ml of water through the dispense head. The LCD will display the message **'Cleaning in Progress'** throughout the cleaning cycle.



Safety First! Keep hands clear of the brewer mechanism during the cleaning routine.

5. When the cleaning cycle is complete the LCD will display the message **'Cleaning Cycle Complete'**. Press the **X (Exit)** key on the drink selection keypad to return the machine to standby mode. Empty the water from the container.
6. Remove the safety key and close the front door.

4.10 Tea Pot Brewer Cleaning Procedure

The following procedure must be carried out weekly. Proceed as follows:-



Safety First! Never clean or service the tea pot brewer unit while it is in motion as fingers may become trapped in the mechanism.

1. Remove the tea outlet pipe from the dispense head block. Lift and remove the mounting bracket c/w tea pot bowl from the machine.

Split the assembly into its component parts. Clean all parts of the tea pot bowl assembly and mounting bracket using the liquid destaining agent.

Follow the instructions for soak cleaning on the product packaging. Rinse all components with clean water and dry thoroughly.

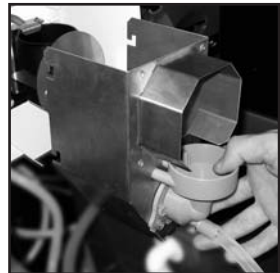

2. Undo the knurled thumb screw retaining the tea brewer unit.

Press down on the retaining clip and remove the complete tea brewer unit from the machine as shown.



3. Split the brewer unit into its separate parts as shown. Clean gauze (a), outlet (b) and bowl (c) using the liquid destaining agent. Follow the instructions for soak cleaning on the product packaging.

Rinse all components in clean water, dry thoroughly, re-assemble and refit to machine. Secure using the knurled thumb screw.

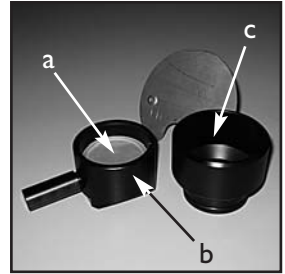

4. Re-fit tea pot bowl/mounting bracket assembly to the machine. Re-connect the outlet pipe to the dispense head block.

4.11 Replacing the CO2 Bottle - Where Fitted

For machines fitted with a carbonator unit, it will be necessary for the operator to regularly check and if necessary, replace the CO2 gas bottle. This will ensure that carbonated vends are always delivered at optimum quality.



Safety First! The CO2 bottle is filled with gas at a pressure of 800 psi and must be stored upright and away from sources of heat. In the event of a leak, ventilate the area in the vicinity of the bottle to remove all traces of gas and contact your supplier.

1. Open the cabinet door and un-hook the safety chain from the gas bottle. Turn off the gas supply from the bottle.
2. Following correct procedures for safe lifting, lift the empty cylinder c/w regulator out of the machine. Carefully undo the locknut using the spanner supplied. Remove the regulator from the empty bottle.

3. Ensure that the seal (1) is seated correctly as shown. If the seal has been damaged in any way, fit a new seal available from the manufacturer.

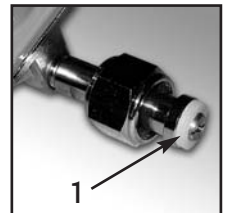

4. Fit the regulator to the new gas bottle and tighten the locknut. Carefully lift the cylinder into the machine ensuring that the gas supply pipe is not trapped or obstructed in any way.

5. Secure the gas bottle using the safety chain. Turn on the gas supply from the bottle and ensure that the regulator indicates a gas pressure of 35 psi. Close the door to restore power to the machine and test vend the carbonated drinks to ensure that the carbonator unit is working correctly.

Section 5 - Service Keypad Functions

Evolution machines are fitted with a service keypad mounted on the rear of the door (photo). This keypad contains the Operators Program entry key and also allows the operator to carry out specific functions during routine cleaning and maintenance.



N.B. During certain operations e.g. View Counters it is necessary for the operator to utilise the selection keypad and LCD mounted on the front of the door to access data.

Please refer to Section 6 - Programming Mode for details of selection keypad layouts and functions.

When the safety key is inserted into the door switch and the machine is switched on, the service keypad allows the operator to carry out the following functions:

5.1 Switch 1 - Program Entry

This switch allows the operator to access the Operators Program (Section 7, page 40).

5.2 Switch 2 - Brewer Open (Freshbrew Models)

This switch operates the brewer fitted to freshbrew machines and allows the operator to replace the filter paper used in paper type brewers or remove the brewer chambers/wipe arms assembly of paperless brewers for cleaning purposes.

5.3 Switch 3 - Rinse/Flush

1. The flush sequence operates automatically and rinses the mixing bowls. Before the sequence begins, the system waits until the water in the boiler is at the correct temperature determined by the thermistor.
2. In order to guarantee the highest standards of cleanliness, the boiler fill valve is disabled, ensuring that the water used in the sequence is delivered at the optimum temperature to kill any micro-organisms.
3. Each hot water valve and the corresponding whipper is switched on in sequence for a pre-set flush time. Once the flush cycle is complete the machine returns to standby mode, ready to vend.
4. To flush the machine:
 - a. Open the front door of the machine and insert the safety key.



Caution: Ensure that a suitable container is placed under the dispense position. Keep hands away from the dispense area whilst the flushing cycle

is in operation.

- b. Press and release the **Flush** switch (3). The flush sequence begins.
- c. Empty the waste water container when complete.

5.4 Switch 4 - Brewer Clean (Freshbrew Models)

1. The brewer clean switch allows the brewer to be cleaned independently. In order to guarantee the highest standards of cleanliness, the boiler fill valve is disabled, ensuring that the water used is delivered at the optimum temperature to kill any micro-organisms.
2. The brewer unit is filled with hot water and then operated through four complete brew cycles.
3. Once the cleaning cycle is complete, the boiler refills and when the water is at the correct temperature, the machine returns to standby mode, ready to vend.
4. To clean the brewer:
 - a. Open the front door of the machine.

Dual Paperless Brewer: Using the clamp supplied, close the tea outlet tube as shown. Insert the safety key.



Caution: Ensure that a suitable container is placed under the dispense position. Keep hands away from the dispense area whilst the cleaning cycle is in operation.



- b. Pour the recommended amount of destaining fluid directly into the top of both brewer chambers. Remove the clamp from the tea dispense pipe.
- c. Press and release the Brewer Flush switch (4). The sequence will begin and the LCD will display the message as shown.
- d. Repeat step 'c' until all traces of the cleaning solution have been removed from the brewer chambers.
- e. Empty the waste water container when complete.

**Sorry Out
of Service
Rinsing**

5.5 Switch 5 - View Counters

The **View Counters** switch (5) allows the operator to access the Data Recall Menu. Entry into this menu allows the operator to view Non-Resettable and Resettable Sales Data, view data relating to Timed Events and Identification Numbers of installed components and (if feature enabled) view SureVend™ assisted vend information. The Resettable Sales Data and SureVend™ Data menus contain an extra sub-menu which

allows the operator to delete the current data from the machines memory. Full details relating to this menu and its contents can be found on pages 40-43.

5.6 Switch 6 - Test Vend

The **Test Vend** switch (6) allows the operator to vend a drink from the machine to ensure correct operation after cleaning or maintenance.

1. When the switch is pressed and released the LCD will display the screen as shown opposite. Press a drink selection button followed by the START/? button to begin the vend sequence.

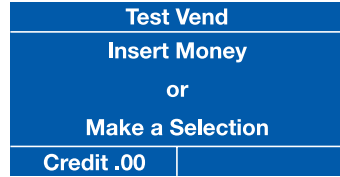

2. Ensure that the selection is correct, has not under/overfilled the cup and most importantly, tastes good!
3. Press the **X** (Exit) key on the drink selection keypad to exit from the Test menu and return to stand-by mode.

5.7 Switch 7 - Cup Test

This switch allows the operator to test the operation of the cup drop unit after refilling the cup stacks. When the switch is pressed the cup drop solenoid is operated and a cup is ejected from the cup drop unit. This function ensures that the mechanism is working correctly.

5.8 Switch 8 - Park Head

When this switch is pressed, the dispense head moves to its fully extended position and stops. Press the switch again to return the dispense head to its correct (homed) position.

5.9 Switch 9 - Boiler Fill (Espresso Machines)

When this switch is pressed, the machine pumps a measured amount of water through the system - approximately 400ml, heating it as it does so. This ensures that heated water is immediately available when a drink is selected. This switch should also be used to purge any water left in the system after the machine has been moved or shut down for any length of time.

5.10 Switch 10 - Machine Cool Down (Espresso Machines)

This switch allows an engineer to work safely on the water system and should not be used by the operator.

5.11 Switch 11 - CoEx® Tablet Clean (Espresso Machines)

This switch when pressed, initiates the CoEx® brewer tablet cleaning routine. Crane Merchandising Systems recommends that this brewer cleaning routine should be carried out on a weekly basis (see page 29 for full details).

5.12 Switch 12 - Reset Waste Counter (F/Brew & Espresso Machines)

IMPORTANT: Every time that the waste container is emptied the waste counter *must* be reset. Press button 12 on the service keypad. Two audible bleeps confirm that the counter has been reset to zero.

5.13 Switch 13 - Syrup Prime (Still/Carbonated Machines)

This switch allows the operator to prime the syrup selections after replacing a syrup container. For full details of this operation, please see page 13.

Section 6 - Programming Mode

6.1 Drink Selection Keypad

Programming mode utilises the drink selection keypad and allows the operator to view and alter stored data within the machines memory. Evolution machines are fitted with either a direct selection (below, left) or build a drink (below, right) keypad. Both types are illustrated below.

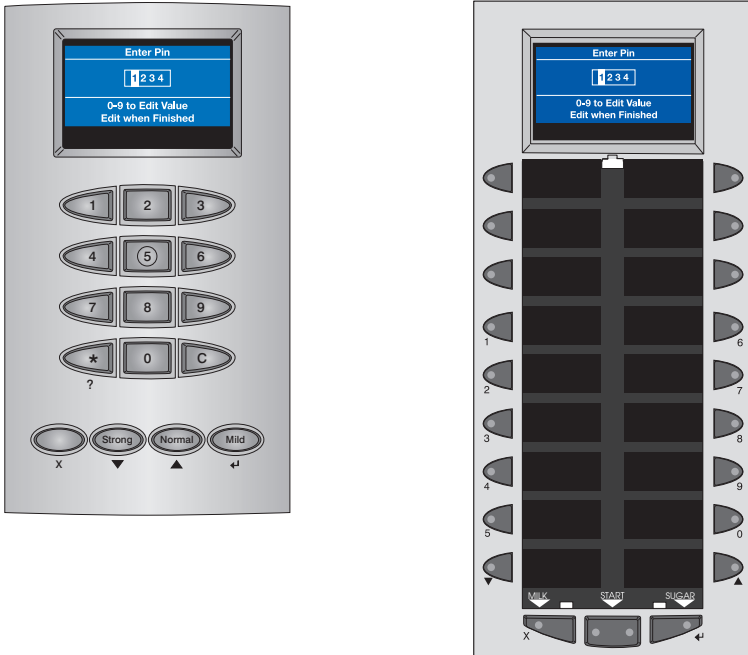

During programming the keys are used as follows:

- Keys 0-9 Used for entering text and numerical data
- ▲/ Normal For indexing up in a program, or incrementing data
- ▼/ Strong For indexing down in a program, or incrementing data
- ↵ / Mild Edit key. Used to select and enter the highlighted menu and to save data to machines memory
- ✕ Exit key. Press to return to the previous menu screen
- START/? Press to 'set all' or 'clear all' data or begin a test sequence.

6.2 Menu Display

The **Evolution** range of freestanding drinks vending machines feature Crane Merchandising Systems' new interactive menu display. The multi line LCD display helps to make navigating the programming menu structure easy and intuitive. It is used to display programming information and will change according to the type of data being updated.

1. The top line of the screen is the Menu title.
2. Selected items are highlighted in white. Press the ▲ (up) or ▼ (down) keys on the drink selection keypad to highlight an item.
3. Press the ↵ (Edit) key to select the item. In this example, pressing the the ↵ (Edit) key will display the Mug Discount screen.
4. The bottom line of the screen will often show important information. In certain configuration menus it will display the current value for the selected item. In the example shown the screen is showing that the current Mug Discount is set at 0.05p. This is a useful way to quickly check stored settings and also confirm that a value has been altered correctly.
5. To return to the Main Menu from any screen, simply press the ✕ (Exit) key until you reach the Main Menu.

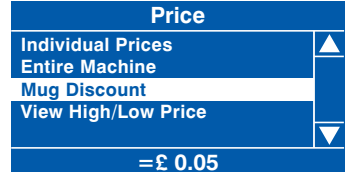

3.3 Accessing the Programming Mode

1. Open the front door of the machine and insert the safety key to restore power to the machine. The machine is now on.
2. Press the Program Entry key (1) on the service keypad, located inside the door (see page 32 for details). The LCD will display the screen as shown opposite. Enter the 4 digit operators entry pin code using the drink selection keypad.



N.B. The factory default operators code is entered by pressing the sequence 2-2-2-2. You may be issued with your own personalised code.

- Press the ↵ (Edit) key. Providing the operator has entered the code correctly, the LCD will display the screen as shown opposite. Press the ↵ (Edit) key to access the operators program or ✕ (Exit) key to return the machine to standby mode



- The LCD on the front of the machine will display the top level programming menu screen - Main Menu. The first available menu Data Recall is highlighted indicating that it can be selected. To move to a different menu press the ▲ (up) or ▼ (down) keys on the drink selection keypad until the required menu is highlighted.

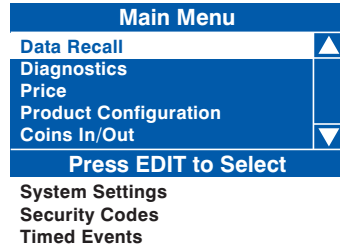

N.B. Coins In/Out will only be displayed on machines fitted with an MDB coin mech.

- With the required menu highlighted, press the ↵ (Edit) key to select it. Using the Price menu as an example, the LCD will display the sub menus as shown opposite.



- Using the ▲ (up) or ▼ (down) keys, the ↵ (Edit) key and the ✕ (Exit) key it is possible to easily navigate through all of the menus contained within the Operators Program.
- To update parameters, key in the actual digits of the number required using the selection keys 0-9. Once the correct parameter has been entered, press the ↵ (Edit) key to overwrite the previous value and save the new parameter in the machines memory. Pressing the ✕ (Exit) key will move back to the previous screen.

Certain programming functions require that the operator chooses either one or multiple parameters within a sub program. These can take the form of either check boxes or radio buttons.

- Check Boxes:** The example opposite shows the Days of Week screen accessed via the Sanitation Events Menu which allows the operator to choose multiple days of the week on which a specific function will take place.

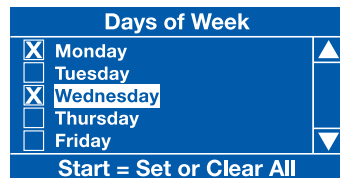

9. Using the ▲ (up) or ▼ (down) keys, scroll through until the required day is highlighted as shown. Pressing the ↵ (Edit) key will select the day, indicated by an X appearing in its adjacent box.

Continue until all required days have been selected. Pressing the ✕ (Exit) key will move back to the previous screen and save the new settings to the machines memory.

N.B. Pressing the START/? key on the drink selection keypad will check all boxes if empty or clear all boxes if checked.

10. **Radio Buttons:** The example opposite shows the State screen accessed via the Timed Events Menu which requires the operator to select one of the options shown. Use the ▲ (up) or ▼ (down) keys to set the required option followed by the ↵ (Edit) key to store/save it (indicated by the filled radio button).

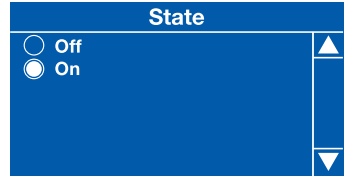

All operator programming for the Evolution range follows the procedures as described above. Specific program actions are described fully in the following section.

Section 7 - Operators Program

To access the Operators Program, enter the programming mode as described in section 6. Once in the Operators Program the LCD on the front of the machine will display the top level programming menu screen - Main Menu.

N.B. Coins In/Out will only be displayed on machines fitted with an MDB coin mech.

Main Menu	
Data Recall	▲
Diagnostics	
Price	
Product Configuration	
Coins In/Out	▼
Press EDIT to Select	
System Settings	
Security Codes	
Timed Events	

Using the ▲ (up) or ▼ (down) keys, ↵ (Edit) key and ✕ (Exit) key on the drink selection keypad the operator can navigate quickly and easily through the operators program menus as described in Section 6.

7.1 Data Recall Menu

Entry into this menu allows the operator to view Non-Resettable and Resettable Sales Data, view data relating to Timed Events and Identification Numbers of installed components and (if feature enabled) view SureVend™ assisted vend information. The Resettable Sales Data and SureVend™ data menus contain an extra sub-menu which allows the operator to delete the current data from the machines memory.

Data Recall	
Non Resettable Sales Data	▲
Resettable Sales Data	
Timed Events	
Identification Numbers	
SureVend	▼
Press EDIT to Select	

1. Non Resettable Sales Data: This menu allows the operator to view and record monetary and sales values. This data cannot be reset and will remain intact for the service life of the controller board (unless the back-up battery is removed).

1. From the Data Recall screen highlight Non Resettable Sales Data and press the ↵ (Edit) key. The LCD will display the screen as shown opposite. From this menu the operator can view data for the Overall Totals (highlighted), By Product, along with data relating to Cash, Cashless and Token Vends.

Non Resettable Sales Data	
Overall Totals	▲
By Product	
Cash	
Cashless	
Token	▼
Press EDIT to Select	

2. To view the Overall Totals screen, press the ↵ (Edit) key on the drink selection keypad. This menu displays both the total £ amount and total vend counts for the following data:

- Sales-£** Displays the total machine sales in £
- Sales-#** Displays the total number of machine vends. This value includes normal, discount and surcharge vend totals.

Discount-£	Displays the total monetary value of all discounts in £
Discount-#	Displays the total number of discounted vends
Test Vend-£	Displays the total monetary value of all test vends in £
Test Vend-#	Displays the total number of test vends
Surcharge-£	Displays the total monetary value of all surcharges in £
Surcharge-#	Displays the total number of surcharge vends
Free Vend-£	Displays the total monetary value of all free vends in £
Free Vend-#	Displays the total number of free vends

N.B. All sales data is presented in a format required by the latest European Vending Association Data Transfer Standards (EVA DTS). Surcharge data fields are not supported by Evolution machines.

3. Scroll through the list displayed using the ▲ (up) or ▼ (down) keys on the front panel and record the audit data.

When complete, press the X (Exit) key on the drink selection keypad to return to the Non Resettable Sales Data menu screen.

Overall Totals		
Sales-£	0.00	▲
Sales-#	0	
Discounts-£	0.00	
Discounts-#	0	
Test Vend-£	0.00	▼
Test Vend-#	0	
Surcharge-£	0.00	
Surcharge-#	0	
Free Vend-£	0.00	
Free Vend-#	0	

4. The operator can also view and record audit data by individual product. Press the ▼ (down) key on the drink selection keypad to highlight By Product on the Non Resettable Sales Data menu screen.
5. Press the ↵ (Edit) key on the keypad to enter the By Product menu screen. This menu contains all of the drink selections available from the machine. Use the ▲ (up) or ▼ (down) keys on the drink selection keypad to scroll through the menu until the required selection is highlighted.

6. Press the ↵ (Edit) key on the keypad to enter the highlighted selection e.g. chocolate. The LCD will display the screen as shown opposite. This menu displays both the total £ amount and total vend count as previously described.

Chocolate		
Price-£	0.00	▲
Sales-£	0.00	
Sales-#	0	
Discounts-£	0.00	
Discounts-#	0	▼
Surcharge-£	0.00	
Surcharge-#	0	
Free Vend-£	0.00	
Free Vend-#	0	

N.B. Individual By Product screens also display the price set for the selection as shown.

The operator can then scroll through the list displayed using the ▲ (up) or ▼ (down) keys on the drink selection keypad and record the audit data.

7. When complete, press the **X** (Exit) key on the drink selection keypad to return the machine to the previous screen. The operator can then view data for more selections using the procedure described above and also access further menus via the Non Resettable Sales Data menu relating to Cash, Cashless and Token audit data.
8. To return the machine to standby mode, press the **X** (Exit) key repeatedly until the LCD displays the standby screen.

2. Resettable Sales Data: This menu contains similar data to that available from the Non Resettable Sales Data menu. However, once viewed and recorded, data from this menu can be cleared from the machines memory.

1. From the Data Recall screen, highlight Resettable Sales Data and press the ↵ (Edit) key. The LCD will display the screen as shown opposite and allow the operator to view data for all parameters as described for Non-Resettable Sales Data. Additionally the menu allows the operator to delete all resettable data via the Clear Data menu.

Resettable Sales Data	
Overall Totals	▲
By Product	
Cash	
Cashless	
Token	▼
Press EDIT to Select	
Clear Data	

2. To view the Overall Totals screen, press the ↵ (Edit) key on the drink selection keypad. This menu displays both the total £ amount and total vend count (since the last time it was cleared) for the data fields shown.

Overall Totals	
Sales-£	0.00 ▲
Sales-#	0
Discounts-£	0.00
Discounts-#	0
Test Vend-£	0.00 ▼
Test Vend-#	0
Surcharge-£	0.00
Surcharge-#	0
Free Vend-£	0.00
Free Vend-#	0

N.B. Please see page 40 & 41 for detailed descriptions of these data fields.

3. Scroll through the list displayed using the ▲ (up) and ▼ (down) keys on the front panel and record the audit data. When complete, press the **X** (Exit) key on the drink selection keypad to return to the Resettable Sales Data menu screen.
4. The operator can also view and record resettable monetary and vend data for individual product by entering the By Product menu, and also view and record data relating to Cash, Cashless and Token vends using their relevant sub-menus.

Once the operator has viewed and recorded required information from these sub-menu's, the data can be deleted via the Clear Data sub menu.

- From the Resettable Sales Data screen, highlight the Clear Data sub menu using the ▼ (down) key and press the ↵ (Edit) key. The LCD on the front of the machine will display the screen as shown opposite, warning the operator that all data will be deleted.

Clear Data	
Are you sure you want to set all resettable data to zero?	
CANCEL - EXIT	OK - EDIT

Either press the ↵ (Edit) key to clear the data or press the ✕ (Exit) key to exit the menu without clearing the data.

3. Timed Events

- From the Data Recall menu scroll down and highlight Timed Events then press the ↵ (Edit) key. The LCD will display the screen as shown opposite. From this menu screen the operator can access then view and record information relating to the four events as shown.

Timed Events	
Power Losses	▲
Last Data Clear	
Last Vend	
Last Clock Set	▼

- To view the Power Losses screen, press the ↵ (Edit) key. The screen displays a list of the 10 most recent occasions when power to the machine has been disconnected in date, time of day and period format. Press the ✕ (Exit) key to return to the Timed Events menu.

Power Losses			
05-08-05	12:25	10Min	▲
04-08-05	12:10	12Min	
			▼

- Press the ▼ (down) key to highlight Last Data Clear, Last Vend and Last Clock Set. Information for these events is displayed along the bottom of the screen.

4. Identification Numbers

- From the Data Recall menu scroll down and highlight Identification Numbers then press the ↵ (Edit) key. The LCD will display the screen as shown opposite. From this menu the operator can access and then view serial number, part number and version type information relating to the main PCB and any MDB coin/card mechanism fitted to the machine.

Identification Numbers	
Main PCB	▲
Coin Mechanism	
Bill Validator	
Card Reader	▼

N.B. Coin Mechanism, Bill Validator and Card Reader will only be displayed if an MDB device is fitted to the machine.

5. SureVend: This menu becomes available when SureVend is enabled via the Product Configuration menu (see page 48).

- From the Data Recall menu scroll down and highlight SureVend then press the ↵ (Edit) key. The LCD will display the screen as shown opposite. From this menu screen the operator can view and record the number of cup drop failures that SureVend has logged and also the number of SureVend assisted vends.

SureVend	
Cup Drop Failures 1-#	▲
SV Assisted-#	
Clear Data	▼

- Once the operator has viewed and recorded the data it can be cleared via the Clear Data menu as described previously.

6. Mug Vends

- This menu displays the number of vends that the machine has made without dropping a cup. Once the operator has viewed and recorded the data it can be cleared via the Clear Data menu as described previously.

Mug Vends	
Mug Vends-#	15 ▲
Clear Data	▼

7. Print Data

- This menu displays the data that can be extracted from the machine when a printer is connected and the corresponding keypad number which needs to be pressed to send the data to the printer.

Print Data	
Press	Data Type
1	All Data
2	Overall Totals
3	By Product
4	Cash

7.2 Diagnostic Menu

- Should a fault occur within the machine, the LCD will display a fault message and in some cases the machine may become inoperable. By accessing the Diagnostic menu and viewing the fault description the operator can in most cases clear the fault and quickly bring the machine back into service.
- When the fault cannot be easily remedied by the operator and requires the services of an approved engineer, the diagnostics screen text displayed enables the engineer to quickly and easily locate and repair the problem, reducing machine down time.

7.3 Price Menu

Entry into this menu allows the operator to enter individual prices for each drink selection available, one price for all drink selections and set a discount to be applied for customers who use their own cup/mug. The menu also contains a sub menu which allows the operator to view the highest and lowest price set in the machines memory.

N.B. Values entered via this menu are only applicable to machines fitted with a coin/card system.

1. Individual Prices: This sub menu allows the operator to set an individual price for each drink selection available from the machine.

Price	
Individual Prices	▲
Entire Machine	
Mug Discount	
View High/Low Price	▼
Press EDIT to Select	

1. With Individual Prices highlighted as shown opposite, press the ↵ (Edit) key to access the menu.

2. Upon entry into this sub menu, all drink selections available from the machine are listed along with the current drink price for the highlighted selection. The example shown illustrates an Instant Coffee selection with a price set currently at 35p.

Individual Prices	
Instant Coffee	▲
Instant Decaff Coffee	
Instant Tea	
Chocolate	
Cappuccino	▼
= £ 0.35	

3. To change the price of the highlighted selection, press the ↵ (Edit) key. The LCD will change and display the screen as shown. To update the price, e.g. increase to 45p, press the sequence 0-0-0-4-5 using the appropriate number keys on the drink selection keypad.

Instant Coffee	
000.45	
0-9 to Edit Value Edit when Finished	

4. Press the ↵ (Edit) key to return to the Individual Prices screen and verify that the new price displays in the status line along the bottom of the display. Use the ▲ (up) or ▼ (down) keys to highlight further selections.

2. Entire Machine: This sub menu allows the operator to set a single price for all selections available from the machine.

1. When highlighted from within the Price menu, the LCD will display the screen, with the current value (e.g. 40p), as shown.

Price	
Individual Prices	▲
Entire Machine	
Mug Discount	
View High/Low Price	▼
= £ 0.40	

- Press the ↵ (Edit) key to access the Entire Machine sub menu. To update the value, e.g. set a price of 50p, press the sequence 0-0-0-5-0 using the appropriate number keys on the drink selection keypad. Press the ↵ (Edit) key to return to the Price menu screen and verify that the new price displays in the status line along the bottom of the display.

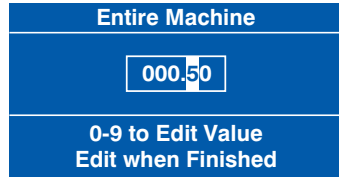

Tip: If most selections are to be sold at the same price, use this menu to quickly set the entire machine to this price, then access the Individual Prices menu to adjust prices for individual selections. Entering a single price for the entire machine will over-ride any individual prices previously programmed.

3. Mug Discount: This sub menu allows the operator to program a discount value against all drink selections for customers who use their own cup/mug.

When a customer places their own cup into the dispense area and selects a drink, the SureVend™ sensors will detect the cup and disable the cup drop mechanism. The price set for Mug Discount is then subtracted from the price of the drink selected and the appropriate change/credit returned to the customer.

N.B. It is important to ensure that any value entered for a mug discount is supported by the coin mechanism fitted to the machine, e.g. if a mug discount is set at 2p but the lowest coin available from the coin mechanism is 5p, the machine will not return the discount to the customer.

- Highlight the Mug Discount sub menu from within the Price menu. The LCD will display the screen, with a current value in the status line (e.g. 5p), as shown. Press the ↵ (Edit) key to access the Mug Discount sub menu.

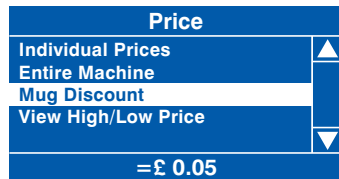

- To enter a discount value, e.g. 6p, press the sequence 0-0-0-0-6 using the appropriate number keys on the drink selection keypad.

- The LCD will change and display the screen as shown. Press the ↵ (Edit) key to return to the Price menu screen and verify that the new price displays in the status line along the bottom of the display.

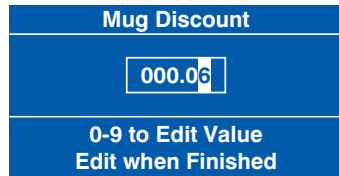

4. View High/Low Price: This sub menu allows the operator to view the highest and lowest values in force, programmed via the Individual Prices sub menu.

N.B. If a single price is currently in force, this value will be displayed in both fields.

7.4 Product Configuration Menu

Entry into this menu allows the operator to disable drink selections and turn SureVend™ on or off. Upon entry into the Product Configuration menu the LCD will display the screen as shown.

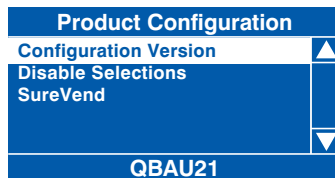

1. Configuration Version: This displays the manufacturer configuration code for the machine and is for information purposes only.

2. Disable Selections: This sub menu allows the operator to disable individual or all drink selections if necessary. With Disable Selections highlighted, press the ↵ (Edit) key to access the menu.

1. Upon entry into the menu the LCD will display the screen as shown. Using the ▲ (up) or ▼ (down) keys, scroll through the menu until the required drink selection is highlighted. Pressing the ↵ (Edit) key will select the drink, indicated by an X appearing in its adjacent box.

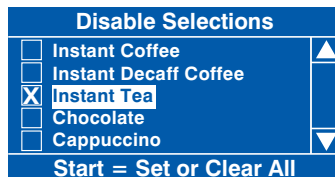

2. If necessary continue until all required drink selections have been checked. Pressing the X (Exit) key will move back to the Product Configuration screen and save the new parameters to the machines memory.

N.B. Pressing the START/? key on the drink selection keypad will check all boxes if empty, disabling all drink selections or clear all boxes if previously checked.

3. On returning to standby mode the selection button light will be extinguished next to any drink selections that have been disabled, indicating to the customer that the drink choice is un-available.

For machines fitted with a carbonator it is also possible to disable either the still or sparkling option for cold drinks.

4. Enter the disable selections sub-menu as previously described and using the ▼ (down) key scroll down until the required cold drink option is highlighted. Pressing the ↵ (Edit) key will disable the option, indicated by an X appearing in the box. To completely disable the selection enter an X into both the Still and Sparkling boxes.

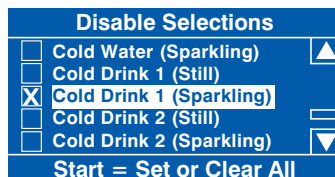

- With the Sparkling option disabled for Cold Drink 1, on returning to standby mode the light for its selection button will be lit indicating that the selection is valid. When a customer presses for the selection only a still vend can be made as shown.



4. SureVend: Entry into this menu allows the operator to turn the SureVend™ product delivery sensor on or off.

SureVend™ Overview:

- SureVend™ ensures that a cup is always available in the cup station before any money is collected or product delivered. The sensing system is a beam of infra-red light across the cup station that is broken by a cup as it falls into position from the cup drop unit, or by a customer placing his own mug in the dispense area.

- The SureVend™ software monitors the cup station sensor during the time that the cup ring is operated and for three seconds afterwards. If a cup is not detected the software will then attempt to drop a cup a second and if necessary, a third time. After three failed vend attempts the cup ring is placed temporarily out of service. The machine will beep once and the LCD will display the Vend Failed message (if set to Pay Vend mode).

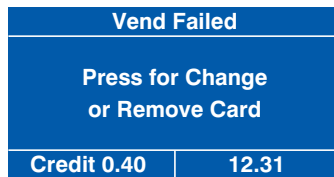

- Customers can now get their money back by pressing the coin return button or removing their card. The LCD will change and display the message **Out of Cups Please Insert Mug**. The machine remains in service but will not vend a cup from the cup drop unit.
- To clear the message and return to standby mode, enter the Diagnostic menu and press the START/? key twice to clear each SureVend™ error displayed. Check and if necessary, clear the cup drop unit and ensure correct operation before leaving the machine.

To configure SureVend™, proceed as follows:

- From the Product Configuration menu highlight SureVend and press the ↵ (Edit) key. By default SureVend™ is factory set to On as indicated by the status line at the bottom of the screen.

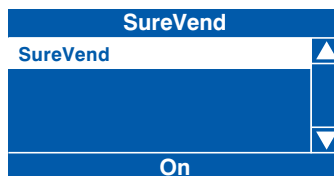

- To disable SureVend™, press the ↵ (Edit) key to enter the SureVend On/Off screen. Use the ▲ (up) key to select Off (indicated by the filled radio button).

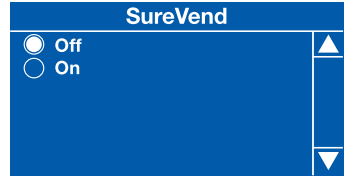

- Press the ↵ (Edit) key to confirm the selection and return to the SureVend screen. Verify that the status line at the bottom of the screen displays Off when SureVend is highlighted.
- Pressing the ✕ (Exit) key will move back to the Product Configuration screen and save the new parameter to the machines memory.

7.5 Coins In/Out Menu

N.B. Coins In/Out will only be displayed on machines fitted with an MDB coin mech.

The Coins In/Out menu emulates the coin mechanism from the front end screen and allows the operator to view information relating to the coin mechanism and eject coins from the machine without opening the door.

- From the Main Menu screen use the ▼ (down) key to scroll through the menu until Coins In/Out is highlighted. Press the ↵ (Edit) key to access the menu screen which will look similar to the example shown.

Coins In/Out			
Press	Coin	Count	Value
1	0.05	34	1.70
2	0.10	18	1.80
3	0.20	9	1.80
4	0.50	8	4.00

- From this screen the operator can view the coin sets in the coin mechanism, the number of coins in each coin stack and the total value of the coins. To eject coins from the mechanism the operator simply presses the relevant button on the keypad eg pressing button 4 will eject a 50p coin. The count will reduce to 7 and the value to 3.50.

7.6 System Settings Menu

This menu allows the operator to view information relevant to the machine and its location, set the current time and date, set and view DTS information, backup and restore machine software, view the machine and I/O board software versions installed in the machine and set temperature and idle screen display options.

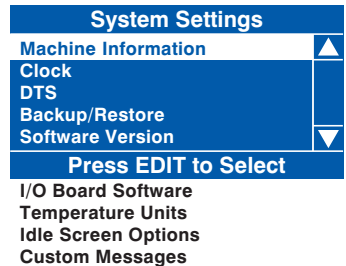

N.B. Custom Messages is not supported at this time.

1. Machine Information: This sub-menu allows the operator to view the identification for the machine and its location.

- From the Systems Settings menu highlight Machine Information and press the ↵ (Edit) key. The LCD will display the screen as shown opposite. To view the Machine ID press the ↵ (Edit) key.

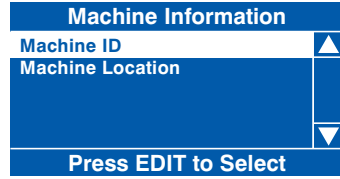

- When complete, press the X (Exit) key to return to the Machine Information menu screen. If necessary press the ▼ (down) then ↵ (Edit) keys to highlight then enter the Machine Location screen. When complete press the X (Exit) key.

2. Clock: The machine displays the current time in either 12 or 24 hour format.

Upon entry to the System Settings menu, the Clock sub menu is highlighted. Press the ↵ (Edit) key to access the Clock sub menu screen. This menu allows the operator to set the date, time and daylight saving via 3 separate sub menus.

N.B. The current date, time and daylight saving (when highlighted) held in the machines memory are displayed in the status line at the bottom of the screen.

- Date:** Press the ↵ (Edit) key to enter the Date menu. The date is displayed in day, month, year format. To set the date, e.g. 27th January 2006, press the sequence 2-7-0-1-0-6 using the appropriate number keys on the drink selection keypad.

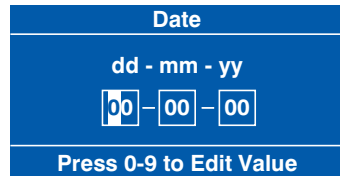

N.B. The text 'Press 0-9 to Edit Value' displayed in the status line at the bottom of the screen will alternate with the text 'Press Start To Change Mode'. Pressing the START/? key on the drink selection keypad allows the date to be displayed in month, day, year format.

Pressing the ↵ (Edit) key will move back to the Clock menu screen and save the date to the machines memory. Confirm that the status line at the bottom of the screen displays the correct date when Date is highlighted.

- Time:** From the Clock menu screen press the ▼ (down) key to highlight the Time menu followed by the ↵ (Edit) key. The LCD will display the screen as shown opposite. By default the time is displayed in 12 hour format. To enter a time of 10:30 PM press the sequence 1-0-3-0 on the drink selection keypad.

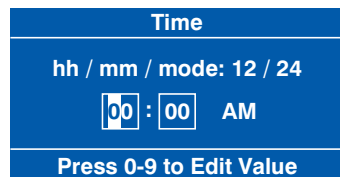

As the operator presses the final zero, the AM value will appear within a dotted box and the text at the bottom of the LCD will now read 'Press Arrows To Select'. Press the ▲ (up) or ▼ (down) key until PM appears in the box.

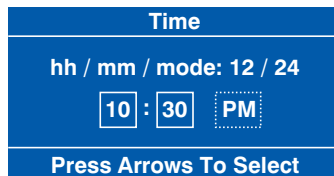

Pressing the ↵ (Edit) key will move back to the Clock menu screen and save the new time to the machines memory. Confirm that the status line at the bottom of the screen displays the correct time when Time is highlighted.

N.B. When set to 12 hour format, the program will only allow the operator to set the numbers 0 or 1 in the first field. Once the number 24 has been entered via the ▲ (up) or ▼ (down) keys to indicate 24 hour format, the operator can reset the first two values to reflect 10:30 PM in 24 hour format e.g. 22:30.

- Daylight Saving:** From the Clock menu screen press the ▼ (down) key to highlight the Daylight Saving menu followed by the ↵ (Edit) key. The LCD will display the screen as shown opposite.



By default daylight savings time is set to Off. To choose one of the available options, press the ▲ (up) or ▼ (down) key until selected (indicated by the filled radio button) followed by the ↵ (Edit) key. Ensure that the required setting is displayed in the status line at the bottom of the screen. Press the ✕ (Exit) key to return to the main menu.

- DTS:** Entry into this menu allows the operator to configure the machine in order to send audit data relating to sales and events stored in the machines memory to a data carrier or other device.

Data Transfer Standard (EVA-DTS) - Overview: The standard makes it possible to transfer information from vending machines/payment systems to PC-based accounting/management systems and/or the opposite way. It is important that all suppliers of vending machines and payment systems agree to a common standard for the Electronic Data Transfer, because only this way the operator can be sure that all his equipment can be read out and programmed by means of the same handheld terminal.

- DTS Standby Mode:** Scroll down and highlight DTS from the System Settings menu. Press the ↵ (Edit) key to access the menu. The LCD will display the screen as shown. The first sub-menu DTS Standby Mode is highlighted with its current state (DDCMP) shown in the bottom line.

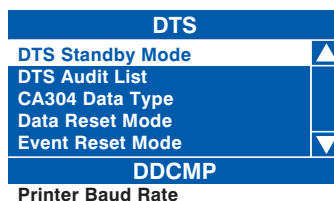

The machine is factory set to enable data transfer via the optical DDCMP link. To change this to the DEX setting, press the ↵ (Edit) key to access the menu and the ▲ (up) key to select DEX (indicated by the filled radio button. Press the ↵ (Edit) key to save the selection.

N.B. Even if the default is set to DDCMP, once the controller detects a DEX activity, it will automatically switch to the other mode. However, setting the default to the correct protocol will speed up response time.

The operator can now download data from the machine by plugging a DEX enabled device into the DEX port (J36) on the I/O board, located on the rear of the door.

2. **DTS Audit List:** From this sub-menu the operator can select which data is transferred from the machine to a DEX/DDCMP data carrier. Scroll down and highlight DTS Audit Data. Press the ↵ (Edit) key to access the menu. The LCD will display the screen as shown.

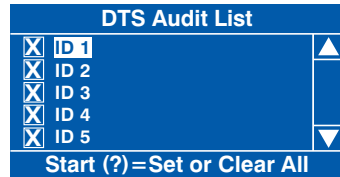

All data and events fields within a vending machine are assigned a unique code determined by the Standard. From this sub-menu the operator can choose to allow all fields to be available for download by pressing the START/? key or scrolling through the list and adding an X to the required fields.

3. **CA304 Data Type:** This sub-menu determines whether the the data will be displayed as currency or numerical, for example, assuming that the value of pound coins in the machine is £3.00, when set to currency CA304 will read 300 in the DEX/DDCMP report. When set to numeric it will read 3.
 4. **Data Reset Mode:** This field can be set to either AUTO or SAVE from within the sub-menu. When set to AUTO, all resettable data will be reset after a successful read.
 5. **Event Reset Mode:** This field can be set to either AUTO or SAVE from within the sub-menu. When set to AUTO, all event data will be reset after a successful read.
 6. **Printer Baud Rate:** This allows the operator to set the correct baud rate for a serial printer if one is to be used. It is important for this to be set correctly to ensure successful data transfer.
- 4. Backup/Restore:** This menu allows the operator to manually backup information stored in the machines memory to the controller board.

N.B. It is also possible for the operator to programme Backup as a timed event, thus ensuring even greater security for the information stored in memory. This ensures that the machine can easily be restored to its last operational state should the information be lost through corruption or power failure. For full details see page 60.

1. Scroll down and highlight Backup/Restore from the System Settings menu. Press the ↵ (Edit) key to access the menu. If this is the first time that a backup has been selected the LCD will display the screen as shown.

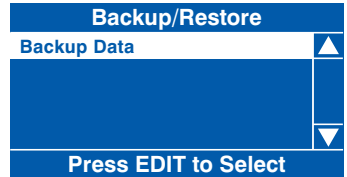

2. Press the ↵ (Edit) key to access the menu. The LCD will display the screen as shown. To backup the memory press the ↵ (Edit) key. After a few seconds the machine will beep once and the **Initialising** screen will be displayed before the machine returns to standby mode, ready to vend.

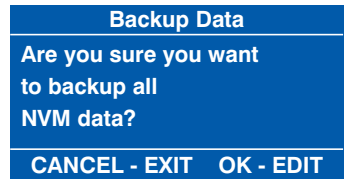

3. When accessing the Backup/Restore sub-menu after backups of the memory have been made, the information changes and the operator is presented with the screen as shown. The first sub-menu, Last Backup is highlighted with the date and time this occurred displayed at the bottom of the screen.

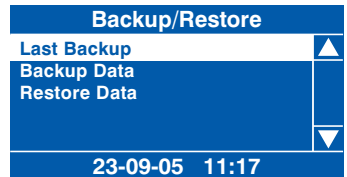

4. To restore the machines memory to the last available backup, scroll down using the ▼ (down) key, highlight Restore Data and press the ↵ (Edit) key to access the menu. The LCD will display the screen as shown. Press the ↵ (Edit) key to restore the backed up data. After a few seconds the machine will beep once and the Initialising screen will be displayed before the machine returns to standby mode, ready to vend.

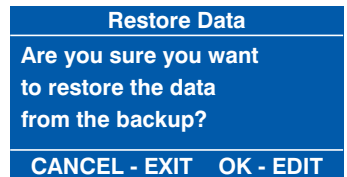

5. Software Version: The Software version menu displays the version number of the software installed and is for information only. The menu also displays the current time and date.

6. I/O Board Software: This menu displays the version number of the I/O board software installed and is for information only.

7. Temperature Units: This menu allows the operator to change the way that the temperature is displayed, either °C or °F, on the LCD when the machine is in standby mode. Use the ▲ (up) or ▼ (down) keys to set the required option followed by the ↵ (Edit) key to store/save it (indicated by the filled radio button).

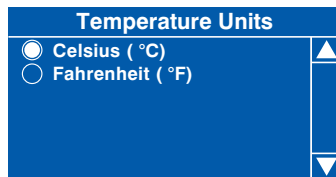

8. Idle Screen Options: This menu allows the operator to configure the LCD so that it displays either the time or the time and water temperature with the standby message when idle. To configure the idle screen options, proceed as follows:

1. From the System Settings menu press the ▼ (down) key to highlight Idle Screen Options and press the ↵ (Edit) key to access the menu.

2. Press the ▼ (down) key to highlight the required option, eg Time and Temp (indicated by the filled radio button). The LCD will display the screen as shown opposite. Press the ↵ (Edit) key to return to the System Settings screen. With Idle Screen Options highlighted, verify that the status line confirms the option is set to Time and Temp.

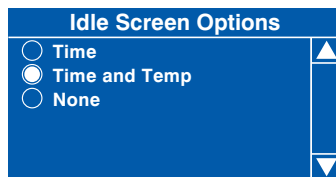

3. Press the X (Exit) key until the machine exits the engineers program into standby mode. The LCD will display the standby message with the time and date as shown.

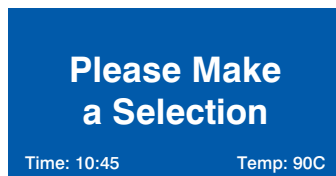

7.7 Security Codes Menu

The security code for entry into the Operators Program is factory set so that the operator presses button 1 on the service keypad followed by the sequence 2-2-2-2 on the drink selection keypad. On no account should this code be altered without first consulting your supervisor or manager.

7.8 Timed Events Menu

1. Time of Day Events: From this menu the operator can set up inhibited vend periods, free vend periods and discounted vend periods.

The following example describes how the operator can program the machine to free vend specific drink selections between 10.30 am and 2:30 pm on week days.

- From the Main Menu press the ▼ (down) key until Timed Events is highlighted then press the ↵ (Edit) key twice to access the Time of Day menu screen. The LCD will display the screen as shown.

Time Of Day Events		
1	Inhibit	Off ▲
2	Inhibit	Off
3	Inhibit	Off
4	Inhibit	Off
5	Free Vend	Off
6	Free Vend	Off ▼

N.B. Although event 1 is shown as Inhibit, it is possible for the operator to set event 1 as the first Free Vend (or Discounted Vend) period.

- Press the ↵ (Edit) key to access the menu. The LCD will display the screen as shown. By default the current State is set to Off as indicated by the status line at the bottom of the screen.

1	
State	▲
Event Type	
Start Time	
Stop Time	
Days Of Week	▼
Off	

- Press the ↵ (Edit) key to access the State sub menu. Using the ▼ (down) key, set the state to On (indicated by the filled radio button). Press the ↵ (Edit) key to return to the Event 1 screen. Verify that the status line confirms the State is set to On.

State	
<input type="radio"/> Off	▲
<input checked="" type="radio"/> On	
	▼

- Press the ▼ (down) key to highlight Event Type and press the ↵ (Edit) key to access the menu. Using the ▼ (down) key, set the Event Type to Free Vend (indicated by the filled radio button). Press the ↵ (Edit) key to return to the Event 1 screen. Verify that the status line confirms the Event Type is set to Free Vend.

Event Type	
<input type="radio"/> Inhibit	▲
<input checked="" type="radio"/> Free Vend	
<input type="radio"/> Discount	▼

- Press the ▼ (down) key to highlight Start Time and press the ↵ (Edit) key. From this menu the operator sets the time at which the free vend period will start. Press the sequence 1-0-3-0, using the drink selection keypad, to set the time. If necessary use the ▲ (up) or ▼ (down) key until AM appears in the dotted box.

Start Time	
hh / mm / mode: 12 / 24	
10	: 30 AM
Press Arrows To Select	

- Press the ↵ (Edit) key to return to the Event 1 screen. Verify that the correct start time is displayed in the status line at the bottom of the screen.

7. Press the ▼ (down) key to highlight Stop Time and press the ↵ (Edit) key. From this menu the operator sets the time at which the free vend period will end. Press the sequence 0-2-3-0, using the drink selection keypad, to set the time. If necessary use the ▲ (up) or ▼ (down) key until PM appears in the dotted box.

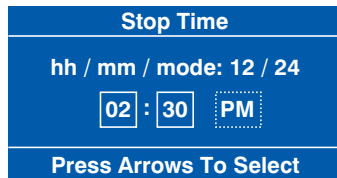

8. Press the ↵ (Edit) key to return to the Event 1 screen. Verify that the correct stop time is displayed in the status line at the bottom of the screen.

9. Press the ▼ (down) key to highlight Days Of Week and press the ↵ (Edit) key. The operator can now set the days on which the free vend period will take place. Upon entry to the sub menu, the first day, Monday will be highlighted with an empty box. Pressing the ↵ (Edit) key will select the day, indicated by an X appearing in its adjacent box.

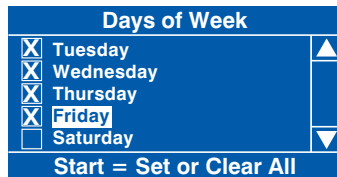

Using the ▼ (down) key and the ↵ (Edit) key, highlight and select additional days of the week that the free vend period will take place. When complete press the ✕ (Exit) key to return to the Event 1 screen.

10. Press the ▼ (down) key to highlight Selections and press the ↵ (Edit) key. The operator can now set the drink selections that will be available during the free vend period. Upon entry to the sub menu, the Freshbrew Coffee selection will be highlighted with an empty box. Pressing the ↵ (Edit) key will select the day, indicated by an X appearing in its adjacent box.

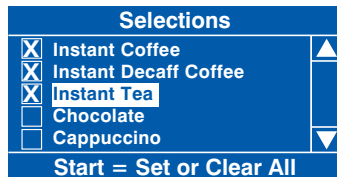

Using the ▼ (down) key and the ↵ (Edit) key, highlight and select additional drink selections that will be available during the free vend period.

Tip - Items 9 & 10: To set the required days/selections quickly, press the START/? key to check all boxes, then using the ▼ (down) key, scroll and highlight the days/selections not required and press the ↵ (Edit) key to remove the X from the corresponding box.

11. Press the ✕ (Exit) key three times to return to the Timed Events Menu.

Using the previous sequence the operator can quickly and easily set up additional free vend periods and inhibit vend and/or discount vend periods if required.

- When setting up a discount price period it is necessary for the operator to enter a value for the discount. Follow the procedure as described previously to enter a discount vend period and set the state, start time, stop time and days of the week that the event will occur.

- The operator can now enter a Discount menu in order to enter a discount value as a percentage (%). The LCD will display a screen similar to the one shown opposite. With Discount highlighted, press the ▼ (Edit) key to access the Discount screen.

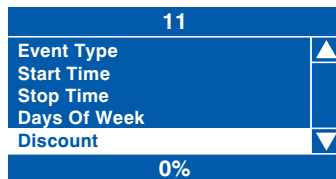

- To enter the discount value, e.g. 50%, press the sequence 5-0 using the appropriate number keys on the drink selection keypad. Press the ↵ (Edit) key to return to the 11 (Discount) screen and verify that the status line displays the discount percentage value entered.



N.B. When machine is fitted with a coin mechanism, please ensure that discount value entered can be supported by the coin tubes.

- Press the X (Exit) key three times to return to the Main Menu screen.

2. Sanitation Events Menu: This sub menu allows the operator to select periods when the machine will automatically flush through the water system via the 6 timed and 6 post vend flush periods available. The default setting for all flush periods is Off.

- From the Main Menu press the ▼ (down) key until Timed Events is highlighted then press the ↵ (Edit) key.

- Once in the Timed Events menu press the ▼ (down) key to highlight Sanitation Events Menu then press the ↵ (Edit) key. The LCD will display the screen as shown.

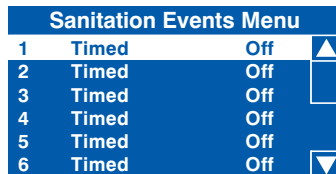

The following example describes how the operator can program a timed event to flush the water system at 07.00 am, everyday.

- To set up the first timed flush, press the ↵ (Edit) key to access the 1 Timed sub menu. The LCD will change and display the screen as shown. By default the current State is set to Off as indicated by the status line at the bottom of the screen.

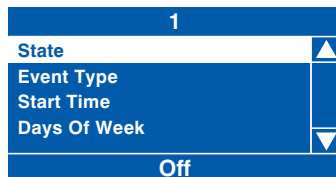

- Press the ↵ (Edit) key to access the State sub menu. Using the ▼ (down) key, set the state to On (indicated by the filled radio button). Press the ↵ (Edit) key to return to the 1 (Timed) screen. Verify that the status line confirms the State is set to On.



- Press the ▼ (down) key to highlight Event Type. By default the event is set to Timed as indicated by the text displayed in the status line at the bottom of the screen. Therefore it is not necessary for the operator to enter this sub menu.

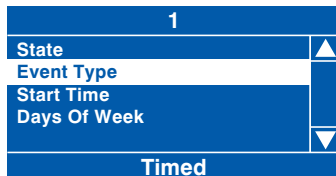

- Press the ▼ (down) key to highlight Start Time and press the ↵ (Edit) key. From this menu the operator sets the time at which the sanitation event will start. Using the drink selection keypad, press the sequence 0-7-0-0 to set the time. If necessary use the ▲ (up) or ▼ (down) key until AM appears in the dotted box.

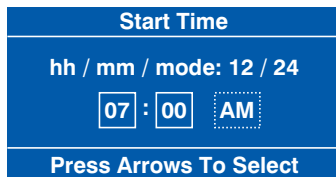

- Press the ↵ (Edit) key to return to the 1 (Timed) screen. Verify that the correct start time is displayed in the status line at the bottom of the screen.

- Press the ▼ (down) key to highlight Days Of Week and press the ↵ (Edit) key. From this menu the operator can set the days on which the sanitation event will take place. To select everyday (Monday - Sunday), press the START/? key on the drink selection keypad. The program automatically places an X in every box indicating that each day is selected.

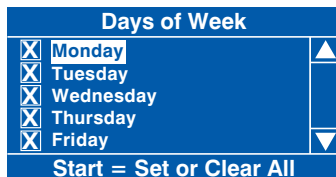

N.B. To select individual days, scroll through the menu using the ▲ (up) or ▼ (down) keys until the required day is highlighted. Press the ↵ (Edit) key to select the day, indicated by an X appearing in its adjacent box.

- Press the X (Exit) key three times to return to the Timed Events Menu. Using the sequence described above the operator can quickly and easily set up additional sanitation event periods for the machine.

It is also possible for the operator to program up to six post vend sanitation events. The following example describes how the operator can program a post vend event to flush the water system 12 minutes after each vend.

- From the Main Menu press the ▼ (down) key until Timed Events is highlighted then press the ↵ (Edit) key. Once in the Timed Events menu press the ▼ (down) key to highlight Sanitation Events Menu then press the ↵ (Edit) key. Press the ▼ (down) key until the first Post Vend event is highlighted. The LCD will display the screen as shown.

Sanitation Events Menu			
2	Timed	Off	▲
3	Timed	Off	
4	Timed	Off	
5	Timed	Off	
6	Timed	Off	
7	Post Vend	Off	▼

- With Post Vend highlighted, press the ↵ (Edit) key to access the 7 Post Vend sub menu. The LCD will change and display the screen as shown. By default the current State is set to Off as indicated by the status line at the bottom of the screen.

7	
State	▲
Event Type	
Delay	▼
Off	

- Press the ↵ (Edit) key to access the State sub menu. Using the ▼ (down) key, set the state to On (indicated by the filled radio button). Press the ↵ (Edit) key to return to the 7 (Post Vend) screen. Verify that the status line confirms the State is set to On.

State	
<input type="radio"/> Off	▲
<input checked="" type="radio"/> On	
▼	

- Press the ▼ (down) key to highlight Event Type. By default the event is set to Timed as indicated by the text displayed in the status line at the bottom of the screen. Therefore it is not necessary for the operator to enter this sub menu.

7	
State	▲
Event Type	
Delay	▼
Post Vend	

- Press the ▼ (down) key to highlight Delay. The status line indicates the factory default delay which is set to 0.1hrs (6 minutes). To change the value so that the machine will self clean 12 minutes after a drink is vended press the ↵ (Edit) key to access the Delay sub menu. The LCD will display the screen as shown. Using the drink selection keypad, press the sequence 0-0-2 to set the new delay.

Delay	
00.2	
0-9 to Edit Value	
Edit when Finished	

Press the ↵ (Edit) key and verify that the status line confirms that Delay (when highlighted) is set to 0.2hrs.

- Press the ✕ (Exit) key three times to return to the Timed Events Menu. Using the sequence described above the operator can quickly and easily set up additional post vend sanitation event periods for the machine if required.

N.B. A sanitation event, either timed or post vend, dispenses water into the drip tray. If the tray reaches its full limit the machine will be 'Out Of Service'.

3. Backup Events Menu: This sub menu allows the operator to program the machine to perform an automatic backup of all user configurable settings and sales data stored in its memory. The default setting for Backup Events is Off.

1. From the Main Menu press the ▼ (down) key until Timed Events is highlighted then press the ↵ (Edit) key.

2. Once in the Timed Events menu press the ▼ (down) key twice to highlight Backup Events Menu then press the ↵ (Edit) key. The LCD will display the screen as shown.

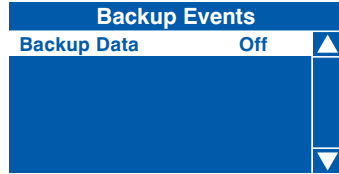

3. Press the ↵ (Edit) key to access the 1 Backup Data sub menu. The LCD will change and display the screen as shown. By default the current State is set to Off as indicated by the status line at the bottom of the screen.



4. Press the ↵ (Edit) key to access the State sub menu. Using the ▼ (down) key, set the state to On (indicated by the filled radio button). Press the ↵ (Edit) key and verify that the status line confirms the State is set to On.

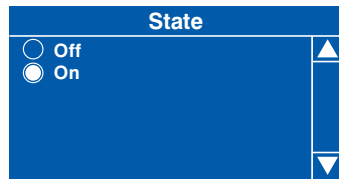

5. Press the ▼ (down) key to highlight Start Time and press the ↵ (Edit) key. Using the drink selection keypad, set the time at which the Backup event will start. If necessary use the ▲ (up) or ▼ (down) key until AM appears in the dotted box.

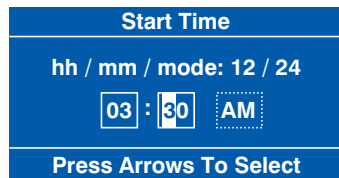

6. Press the ↵ (Edit) key and verify that the correct start time is displayed in the status line at the bottom of the screen.

7. Press the ▼ (down) key to highlight Days Of Week and press the ↵ (Edit) key. From this menu the operator can set the days on which the Backup event will take place. To select everyday (Monday - Sunday), press the START/? key on the drink selection keypad. The program

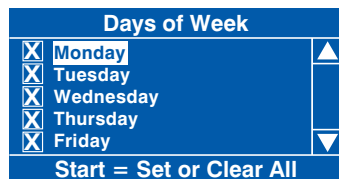

automatically places an X in every box indicating that each day is selected.

N.B. To select individual days, scroll through the menu using the ▲ (up) or ▼ (down) keys until the required day is highlighted. Press the ↵ (Edit) key to select the day, indicated by an X appearing in its adjacent box.

Section 8 - Dispense Pipe Lengths

8.1 Instant Machine - 6 Canister

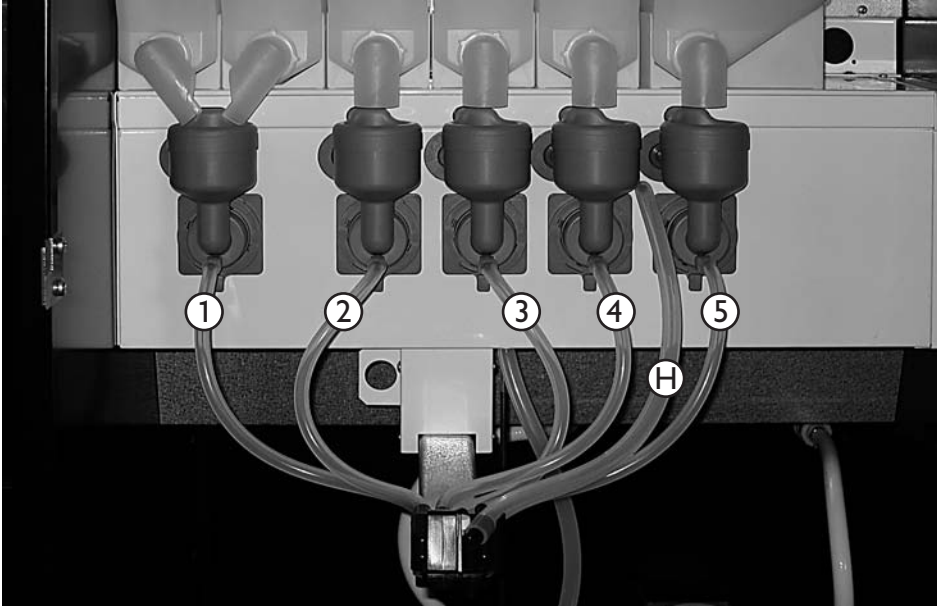

Pipe No	Diameter	Length
1	6 mm I.D. x 10 mm O.D.	350 mm
2	6 mm I.D. x 10 mm O.D.	300 mm
3	6 mm I.D. x 10 mm O.D.	300 mm
4	6 mm I.D. x 10 mm O.D.	320 mm
5	6 mm I.D. x 10 mm O.D.	350 mm

H = Hot Water Dispense Pipe

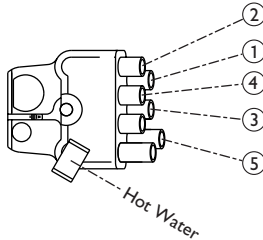

8.2 Instant Machine - 8 Canister

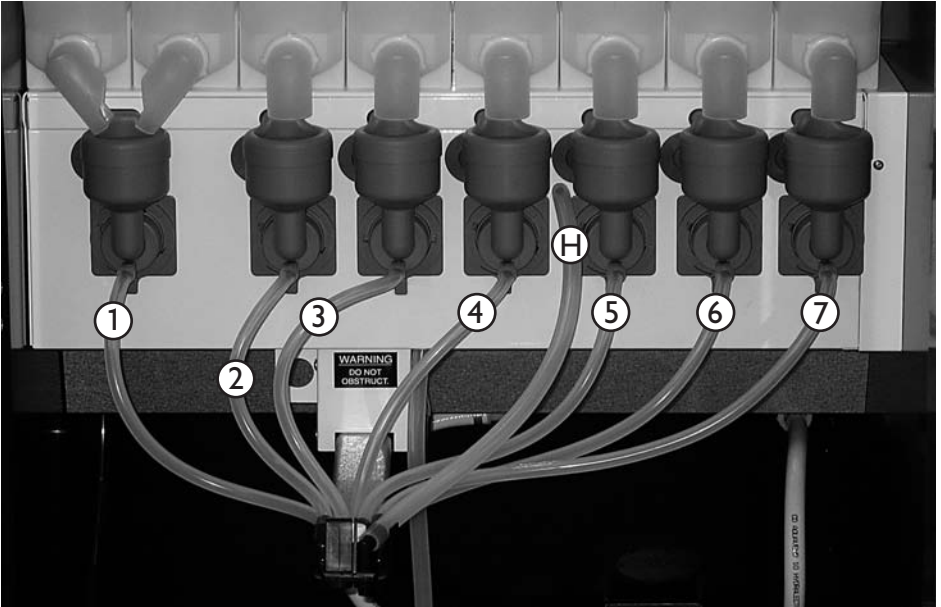

Pipe No	Diameter	Length
1	6 mm I.D. x 10 mm O.D.	350 mm
2	6 mm I.D. x 10 mm O.D.	300 mm
3	6 mm I.D. x 10 mm O.D.	300 mm
4	6 mm I.D. x 10 mm O.D.	320 mm
5	6 mm I.D. x 10 mm O.D.	360 mm
6	6 mm I.D. x 10 mm O.D.	410 mm
7	6 mm I.D. x 10 mm O.D.	460 mm

H = Hot Water Dispense Pipe

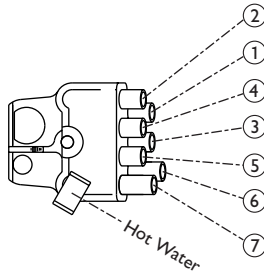

8.3 Single Freshbrew Machine - Paperless Brewer

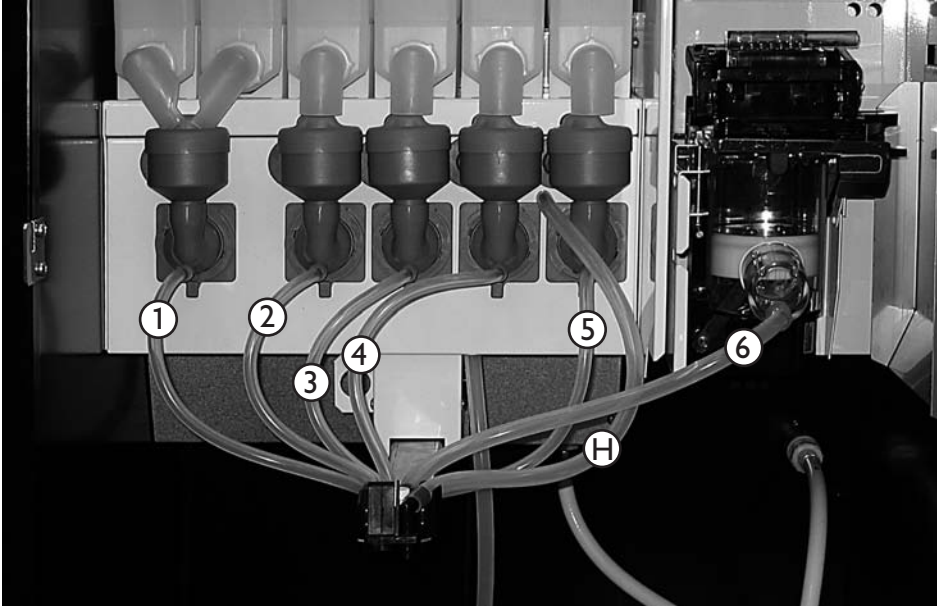

Pipe No	Diameter	Length
1	6 mm I.D. x 10 mm O.D.	350 mm
2	6 mm I.D. x 10 mm O.D.	300 mm
3	6 mm I.D. x 10 mm O.D.	300 mm
4	6 mm I.D. x 10 mm O.D.	300 mm
5	6 mm I.D. x 10 mm O.D.	330 mm
6	8 mm I.D. x 10 mm O.D.	370 mm

H = Hot Water Dispense Pipe

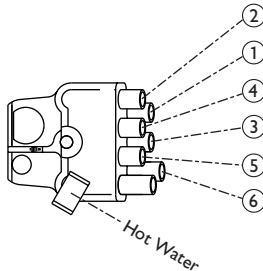

8.4 Double Freshbrew Machine - Paperless Brewer

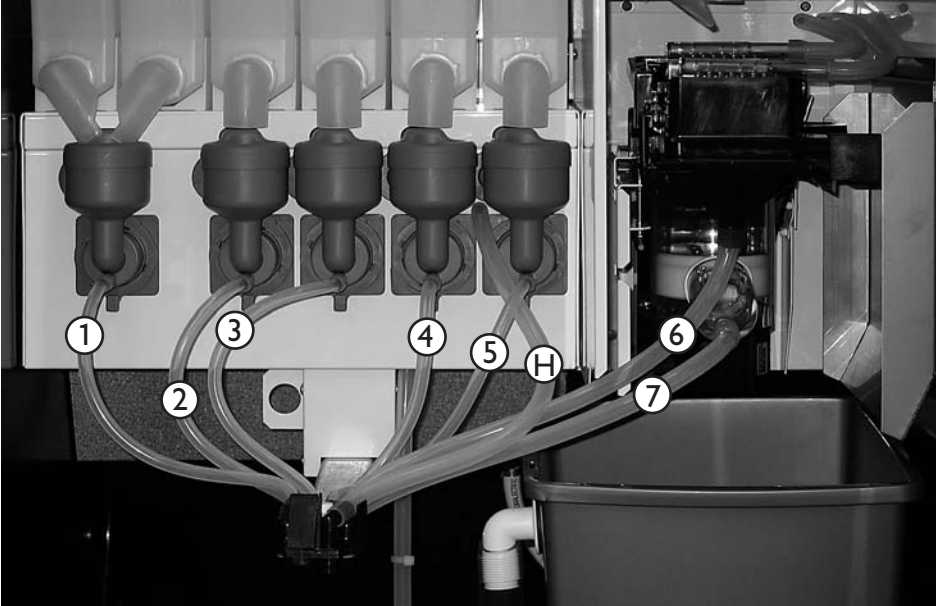

Pipe No	Diameter	Length
1	6 mm I.D. x 10 mm O.D.	350 mm
2	6 mm I.D. x 10 mm O.D.	300 mm
3	6 mm I.D. x 10 mm O.D.	300 mm
4	6 mm I.D. x 10 mm O.D.	300 mm
5	6 mm I.D. x 10 mm O.D.	330 mm
6	8 mm I.D. x 10 mm O.D.	390 mm
7	8 mm I.D. x 10 mm O.D.	370 mm

H = Hot Water Dispense Pipe

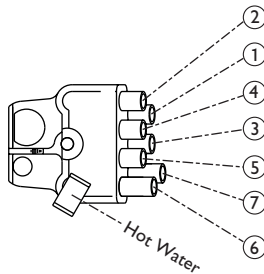

8.5 Freshbrew Machines - Paper Brewer (King)

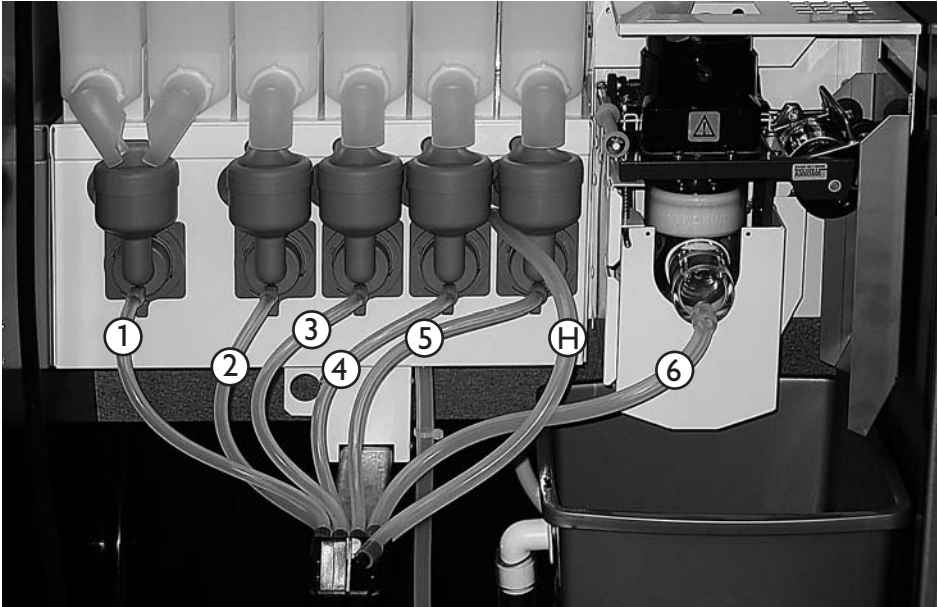

Pipe No	Diameter	Length
1	6 mm I.D. x 10 mm O.D.	350 mm
2	6 mm I.D. x 10 mm O.D.	300 mm
3	6 mm I.D. x 10 mm O.D.	300 mm
4	6 mm I.D. x 10 mm O.D.	300 mm
5	6 mm I.D. x 10 mm O.D.	320 mm
6	8 mm I.D. x 10 mm O.D.	350 mm

H = Hot Water Dispense Pipe

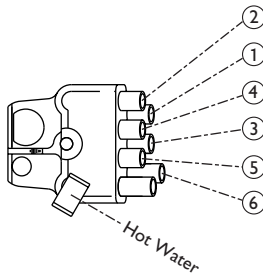

8.6 Espresso Machine

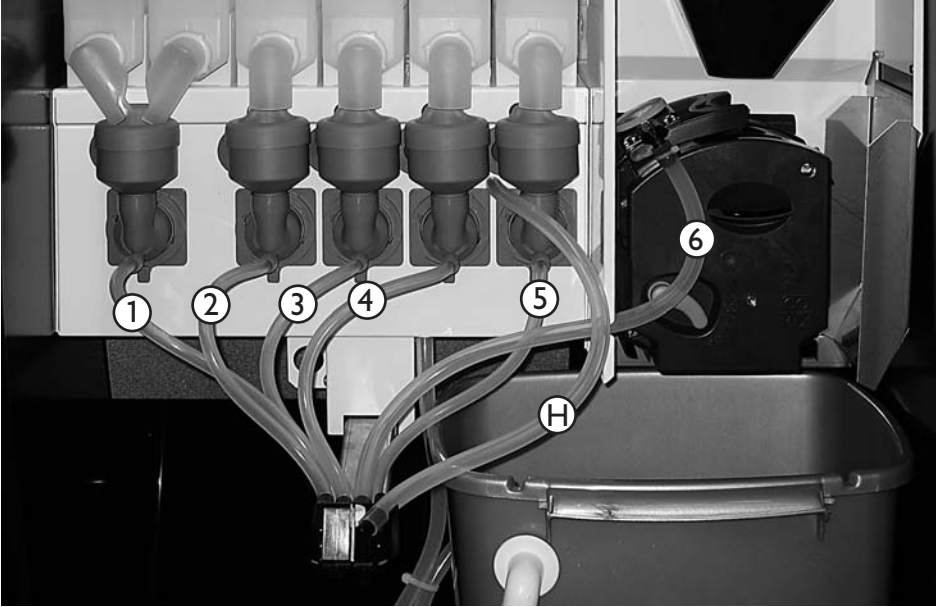

Pipe No	Diameter	Length
1	6 mm I.D. x 10 mm O.D.	350 mm
2	6 mm I.D. x 10 mm O.D.	300 mm
3	6 mm I.D. x 10 mm O.D.	300 mm
4	6 mm I.D. x 10 mm O.D.	300 mm
5	6 mm I.D. x 10 mm O.D.	330 mm
6	8 mm I.D. x 10 mm O.D.	450 mm

H = Hot Water Dispense Pipe

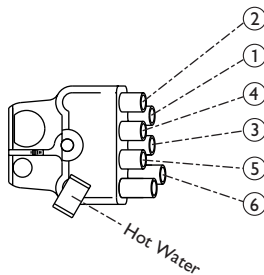

8.7 Espresso Machine Plus Teapot Option

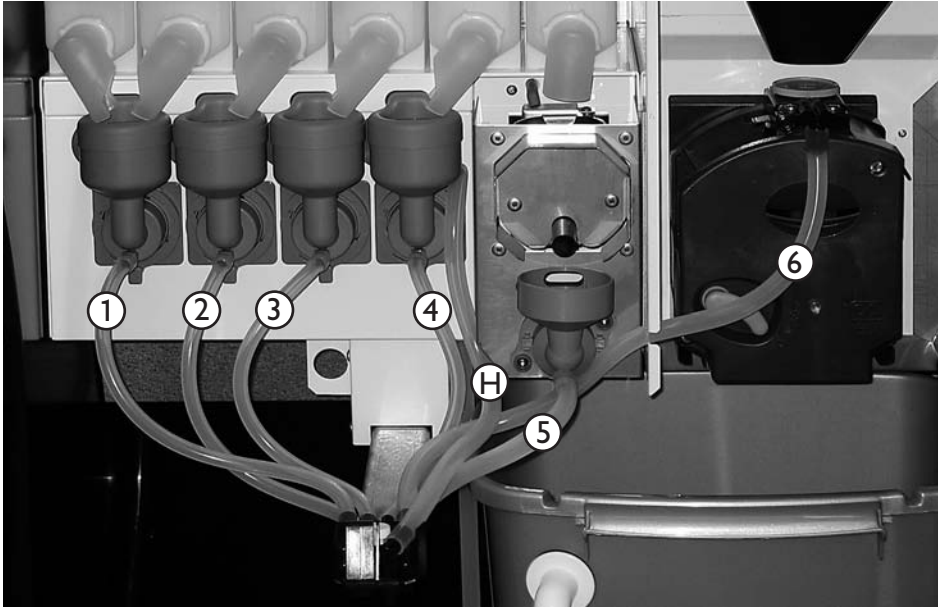

Pipe No	Diameter	Length
1	6 mm I.D. x 10 mm O.D.	360 mm
2	6 mm I.D. x 10 mm O.D.	310 mm
3	6 mm I.D. x 10 mm O.D.	300 mm
4	6 mm I.D. x 10 mm O.D.	300 mm
5	6 mm I.D. x 10 mm O.D.	240 mm
6	8 mm I.D. x 10 mm O.D.	450 mm

H = Hot Water Dispense Pipe

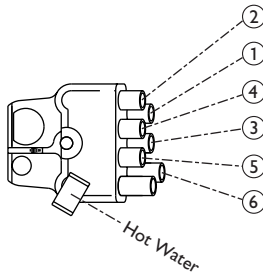

Section 9 - Error Messages And Simple Problem Solving

9.1 Error Messages

The table below lists the error messages that may be encountered and, where applicable, offers the operator solutions for curing them.



Safety First! Should the solution given not cure the problem, or the fault requires the assistance of a trained service engineer, **DO NOT ATTEMPT TO CURE THE FAULT YOURSELF.** Contact your machine supplier for assistance.

Error Message	Cause	Solution
Out Of Cups Please Insert Mug	Cup stacks empty	Refill cup stacks with correct size and type of cup
Sorry Out of Service Mug Sensor Error	Fault with mug sensor	Switch off the power and call engineer
Please Remove Cup	A cup or mug has been left in the vend area	Remove the cup or mug to cancel the error
Sorry Out of Service	Communications fault No IO Comm	Switch off the power and call engineer
Sorry Out of Service Brewer Not Homed	Brewer has not returned to its home position	Switch off the power and call engineer
Sorry Out of Service Brewer Jam	Brewer mechanism faulty	Switch off the power and call engineer
Sorry Out of Service Head Not Homed	Dispense head has not returned to its home position	Switch off the power and call engineer
Sorry Out of Service Head Not Extended	Dispense head has not moved to its extended position	Switch off the power and call engineer
Sorry Out of Service No Monetary Device	The monetary device is not connected or has been configured incorrectly	Switch off the power and call engineer
Sorry Out of Service Invalid Temperature	The temperature device is disconnected or faulty	Switch off the power and call engineer
Out Of Cups Please Insert Mug	SureVend™ has detected an error with the cup drop unit	Switch off the power and call engineer
Sorry Out of Service Low Water	The machine is filling	Wait for the machine to fill with water
Sorry Out of Service Fill Timeout	The machine has failed to fill with water	Check that the water supply to the machine is connected and turned on
Sorry Out of Service Water Tank Heating	The water is heating to the correct operating temperature	Wait for the machine to heat up and enter standby mode

9.1 Error Messages (Cont'd)

Error Message	Cause	Solution
Sorry Out Of Service Waste Bucket Full	The waste bucket is full	Empty, clean and refit the waste bucket
Sorry Out of Service Rinsing	Operator/engineer running the rinse program	Wait until machine completes rinse cycle and returns to standby mode
Sorry Out of Service Out of Coffee	Fresh beans container and/or freshbrew canister empty (Espresso machines) Bean hopper shut-off closed	Refill bean container with fresh beans and/or coffee canister with freshbrew coffee Fully open bean hopper shut-off (see page 23)

9.2 Simple Problem Solving

In the unlikely event of the machine developing a problem, details are given in the table below on how to deal with common faults that can be easily remedied by the operator.



Safety First! Should the remedy given below not cure the problem, or the fault is not listed, **DO NOT ATTEMPT TO CURE THE FAULT YOURSELF.** Contact your machine supplier for assistance.

Fault	Possible Cause	Remedy
Waste bucket overflowing	Level sensor incorrectly located in the bucket	Ensure sensor is positioned correctly
Incorrect drinks dispensed	Ingredient canisters located incorrectly	Refit canisters into their correct positions
Leaking from dispense area	Mixing system 'O' ring fitted incorrectly	Refit correctly and ensure that all mixing stations are water tight
Blank LCD display	Electricity supply turned off	Ensure electricity supply is turned on at the mains
Cups jamming	Incorrect cup size	Remove cups from cup stack and replace with correct size cups
No change given from change giver (where fitted)	(i) Coin tubes jamming (ii) Coin tubes empty or below pre-set level	Clear coin tubes and check for blockage Check and refill coin tubes where necessary
Low water indicated on LCD display	Water supply turned off	Ensure water supply is turned on at stop tap
Carbonated drinks not "fizzy"	CO2 gas bottle empty	Check and if necessary replace. See page 31

9.2 Simple Problem Solving (Cont'd)

Fault	Possible Cause	Remedy
Paper fed brewer unit jamming	(i) Incorrect paper fitted (ii) Filter paper loaded incorrectly (iii) Paper fouling on brewer guard	Remove and fit correct 90mm filter paper Reload paper and ensure that it feeds correctly Adjust brewer guard DO NOT REMOVE
Brewer wiper arms not removing coffee/tea waste. (Paperless freshbrew only)	Brewer chambers refitted incorrectly after cleaning	Refit brewer chambers ensuring that wiper lugs are located correctly. See page 27
LCD shows 'Selection Not Available' and machine will not vend coffee based drinks (Freshbrew & B2C machines)	Waste counter has reached maximum number of vends dispensed through freshbrew or CoEx® brewer	Empty brewer waste bin and reset waste counter. See pages 25 - 30

9.3 Machine Leaking

Should the machine develop a leak, switch off the mains water supply at the stop-tap and if safe to do so, switch off the mains electricity supply. Contact your machine supplier for further assistance.



Safety First! Do not attempt to repair the machine yourself.

Section 10 - Decommissioning The Machine

- Should the machine need to be shut down for short periods, for example over a long weekend, no special treatment is required. The machine should be thoroughly cleaned before the site is closed down and on return it is advisable to vend each drink type to ensure correct operation and to “freshen up” the machine.
- If the machine is to be moved or transported, remove all ingredients and thoroughly clean the machine. Disconnect all electricity and water supplies. The machine should be transported upright at all times. Contact the supplier of the machine for assistance.

Notes



E·V·O·L·U·T·I·O·N

CRANE **MERCHANDISING SYSTEMS™**
A Crane Co. Company

Pipsmore Park, Bumpers Farm Industrial Estate,
Chippenham, Wiltshire SN14 6NQ
Tel: +44 (0)1249 444807 Fax: +44 (0)1249 444819
Email: sales@cranems.co.uk
Website: www.cranems.co.uk