

VULCAN

INSTALLATION & OPERATION MANUAL

VW SERIES DRAWER WARMERS

MODELS

VW1S	ML-126500
VW2S	ML-126502
VW3S	ML-126504
VW4S	ML-126506
VW1SB	ML-126501
VW2SB	ML-126503
VW3SB	ML-126505
VW4SB	ML-126507
VW1D	ML-126508
VW2D	ML-126510
VW3D	ML-126512
VW4D	ML-126514
VW1DB	ML-126509
VW2DB	ML-126511
VW3DB	ML-126513
VW4DB	ML-126515
VW1C	ML-126516
VW2C	ML-126518
VW1CB	ML-126517
VW2CB	ML-126519



TABLE OF CONTENTS

GENERAL.....	3
INSTALLATION	3
Unpacking	3
Location	4
Installation Codes and Standards	4
Electrical Connections	4
Wiring Diagrams	6
OPERATION	9
Controls	9
Before First Use	9
Operating Drawer Warmer	10
Cleaning	11
MAINTENANCE	11
Service and Parts Information	11

Installation, Operation and Care of MODEL VW SERIES DRAWER WARMERS

PLEASE KEEP THIS MANUAL FOR FUTURE USE

GENERAL

Vulcan-Hart Drawer Warmers are produced with quality workmanship and material. Proper installation, usage, and maintenance of your drawer warmer will result in many years of satisfactory performance.

It is suggested that you thoroughly read this entire manual and carefully follow all of the instructions provided.

The VW Series Drawer Warmers provide an efficient means of holding a variety of prepared hot food products at proper temperatures until serving.

- VW-S and VW-SB series have a large 15x20" (38x51cm) over-sized drawer insert.
- VW-D, VW-C, VW-CB, and VW-DB series have a standard 12x20x4" (30x51x10 cm) steam table pan insert.

INSTALLATION

Before installing, verify that the electrical service agrees with the specifications on the rating plate located on the lower rear corner of the drawer warmer. If the supply and equipment requirements do not agree, do not proceed with the installation. Contact your Vulcan-Hart office immediately.

UNPACKING

This drawer warmer was inspected before leaving the factory. The transportation company assumes full responsibility for safe delivery upon acceptance of the shipment. Immediately after unpacking, check for possible shipping damage to the drawer warmer. If the drawer warmer is found to be damaged, save the packaging material and contact the carrier within 15 days of delivery.

Carefully unpack drawer warmer and place in a work-accessible area.

1. Remove banding material holding the carton to the pallet.
2. Remove cardboard carton and plastic bag covering drawer warmer.
3. Carefully lift drawer warmer off carton bottom and place it on the floor or table.
4. Remove legs from the drawer of the drawer warmer.
5. Secure legs to the bottom of the drawer warmer by screwing legs into the holes provided.
6. Remove any and all packaging materials in drawers.

LOCATION

For efficient drawer warmer operation, choose a location that will provide easy loading and unloading without interfering with the final assembly of food orders.

The installation location must allow adequate clearances for servicing and proper operation.

INSTALLATION CODES AND STANDARDS

The drawer warmer must be installed in accordance with:

In the United States of America:

1. State and local codes.
2. National Electrical Code, ANSI/NFPA-70 (latest edition). Copies may be obtained from The National Fire Protection Association, Batterymarch Park, Quincy, MA 02269.

In Canada:

1. Local codes.
2. Canadian Electrical Code, CSA C22.1 (latest edition). Copies may be obtained from The Canadian Standard Association, 178 Rexdale Blvd., Etobicoke, Ontario, Canada M9W 1R3.

ELECTRICAL CONNECTIONS

WARNING: ELECTRICAL AND GROUNDING CONNECTIONS MUST COMPLY WITH THE APPLICABLE PORTIONS OF THE NATIONAL ELECTRICAL CODE AND/OR OTHER LOCAL ELECTRICAL CODES.

WARNING: DISCONNECT ELECTRICAL POWER SUPPLY AND PLACE A TAG AT THE DISCONNECT SWITCH TO INDICATE YOU ARE WORKING ON THE CIRCUIT.

WARNING: THIS APPLIANCE IS EQUIPPED WITH A FLEXIBLE ELECTRIC SUPPLY CORD PROVIDED WITH A THREE-PRONG GROUNDING PLUG. THIS PLUG MUST BE CONNECTED INTO A PROPERLY GROUNDED THREE-PRONG RECEPTACLE. IF THE RECEPTACLE IS NOT THE PROPER GROUNDING TYPE, CONTACT AN ELECTRICIAN. DO NOT REMOVE THE GROUNDING PRONG FROM THIS PLUG.

- All VW-S, VW-SB, VW-D, VW-DB are equipped with a 6 foot cord.
- All VW-C are equipped with an 8 foot cord.

Refer to wiring diagrams in this manual (see pages 6-8).

Electrical Table

Model	Voltage	Phase	NEMA Plug
VW1S, VW2S, VW3S, VW1SB, VW2SB, VW3SB, VW1D, VW2D, VW3D, VW1DB, VW2DB, VW3DB	110/120 208/240	1	5-15 6-15
VW4S, VW4SB, VW4D, VW4DB	110/120 208/240	1	5-15 6-20
VW1C, VW2C, VW1CB, VW2CB	110/120 208/240	1	5-15 6-15

WIRING DIAGRAMS

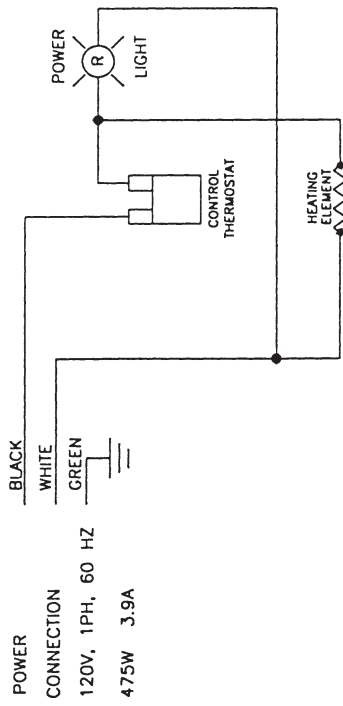

VW1D, VW1DB, VW1S, VW1SB

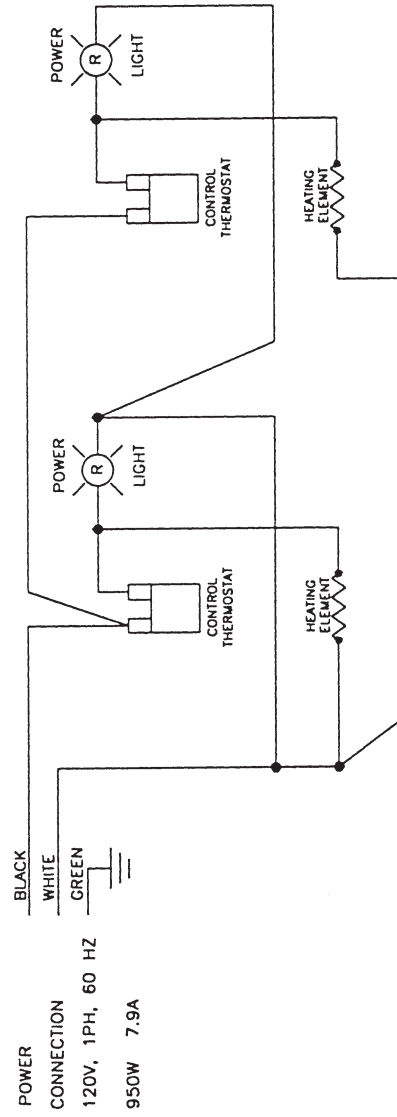

VW2D, VW2DB, VW2S, VW2SB

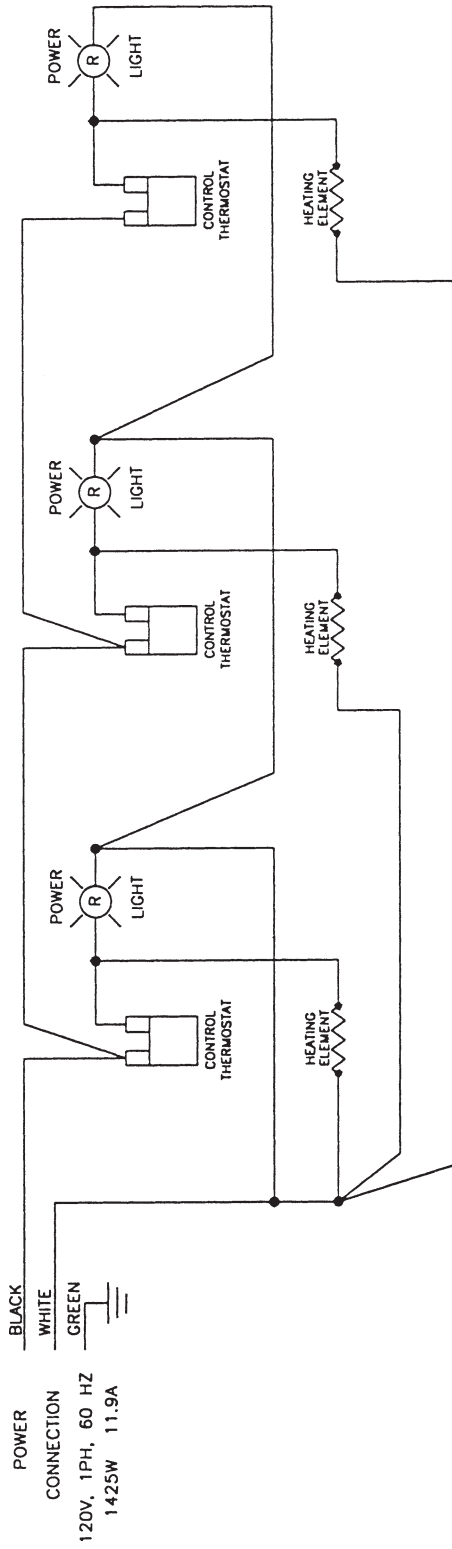

VW3D, VW3DB, VW3S, VW3SB

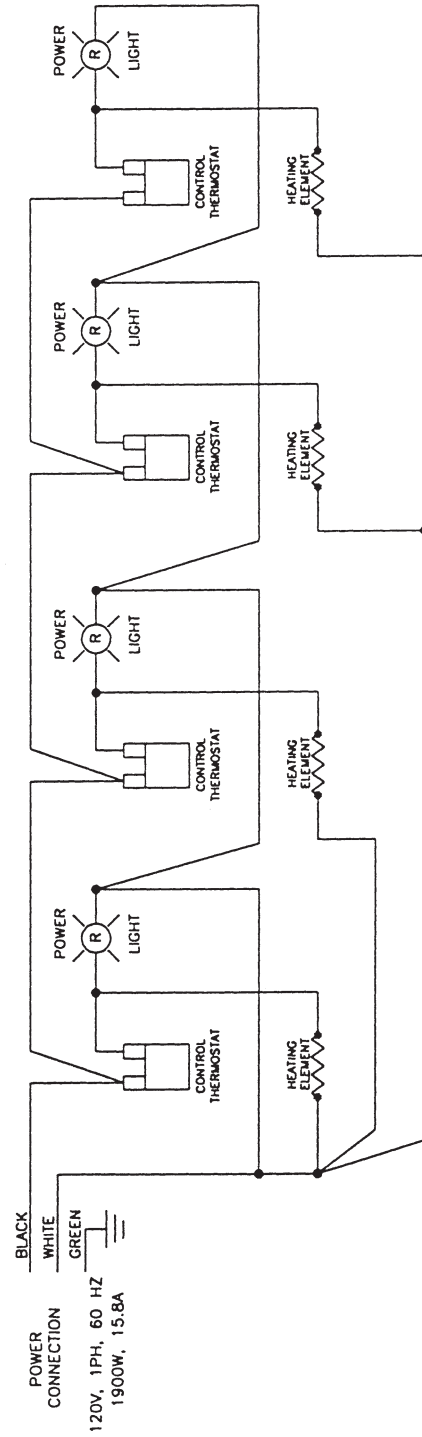

VW4D, VW4DB, VW4S, VW4SB

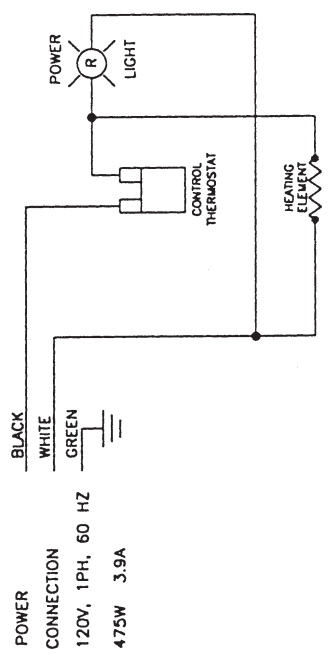

VW1C, VW1CB

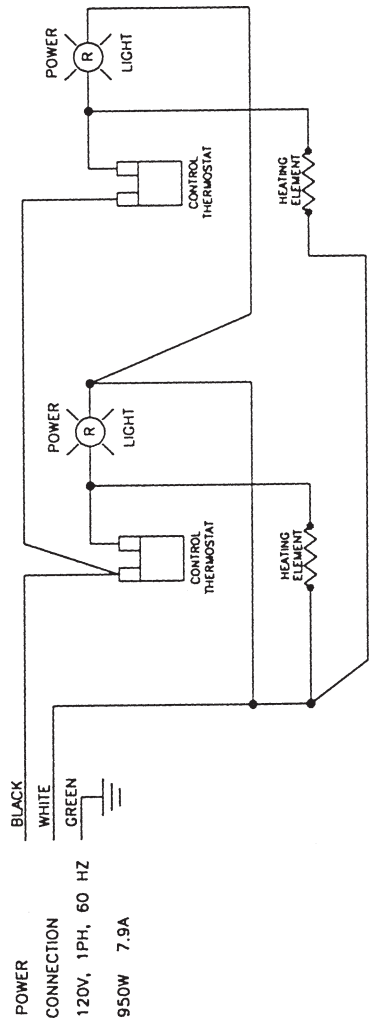

VW2C, VW2CB

OPERATION

WARNING: THE DRAWER WARMER AND ITS PARTS ARE HOT. BE VERY CAREFUL WHEN OPERATING, CLEANING OR SERVICING THE DRAWER WARMER.

CONTROLS (Fig. 1)

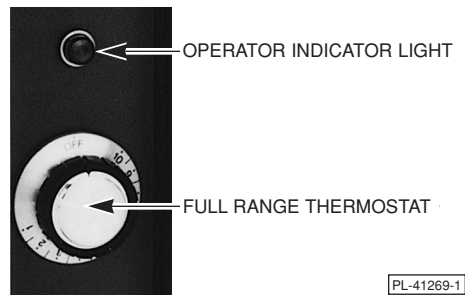

Fig. 1

- | | |
|--------------------------|--|
| OPERATOR INDICATOR LIGHT | – Lit when heat is supplied to drawer warmer. |
| FULL RANGE THERMOSTAT | – Acts as the ON/OFF switch to the drawer warmer system. <ul style="list-style-type: none">• Turn to desired temperature setting to turn ON.• Turn counterclockwise until it stops to turn OFF. |
| THERMOMETER (not shown) | – Indicates interior temperature of drawer warmer. |

BEFORE FIRST USE

WARNING: UNPLUG ELECTRICAL POWER SUPPLY BEFORE CLEANING.

1. Clean drawer warmer thoroughly.
 - a. Use mild soap and water solution to clean drawer warmer.
 - b. Rinse thoroughly and wipe dry with a soft clean cloth.
 - c. Clean all accessories.
 - d. Rinse thoroughly and wipe dry.
2. Operate drawer warmer in highest temperature setting for a period of 30-45 minutes. (See Operating Drawer Warmer.)

OPERATING DRAWER WARMER

1. Connect electric power supply.
2. Turn thermostat knob to desired setting.
 - Heating elements begin heating.
 - Operator indicator light is lit.
3. Thermometer will indicate the interior temperature of the drawer warmer.
4. Once desired temperature is reached, heating elements will cycle on and off.
 - Operator light will cycle on and off with the heating elements.
 - Temperature in drawer warmer may fluctuate as the heating elements cycle on and off.
5. Monitor the food product to ensure proper temperatures.

Drawer Warmer Temperatures

The greater the thermostat setting number, the higher the drawer warmer temperature. The lower the thermostat setting number, the lower the drawer warmer temperature.

Thermostat Setting	Approximate Temperature
1	110°F (43°C)
2	120°F (49°C)
3	130°F (54°C)
4	140°F (60°C)
5	150°F (66°C)
6	160°F (71°C)
7	170°F (77°C)
8	180°F (82°C)
9	190°F (88°C)
10	200°F (93°C)

Shutdown

Turn thermostat knob counterclockwise until it stops.

Extended Shutdown

Disconnect electrical power supply.

CLEANING

WARNING: UNPLUG ELECTRICAL POWER SUPPLY BEFORE CLEANING.

Clean drawer warmer interior with a mild soap and water whenever food spill occurs. Never use harsh chemicals or abrasive pads to clean drawer warmer.

Daily

1. Allow drawer warmer to cool before cleaning.
2. Clean drawers and the interior of the drawer warmer with a mild soap and water.
3. Rinse and dry with a soft dry cloth.
4. Clean exterior of drawer warmer with a clean damp cloth.

MAINTENANCE

WARNING: THE DRAWER WARMER AND ITS PARTS ARE HOT. BE VERY CAREFUL WHEN OPERATING, CLEANING OR SERVICING THE DRAWER WARMER.

WARNING: UNPLUG ELECTRICAL POWER SUPPLY BEFORE SERVICING THE DRAWER WARMER.

SERVICE AND PARTS INFORMATION

To obtain service and parts information concerning this warmer, contact the Vulcan-Hart Service Agency in your area (refer to listing supplied with the warmer), or Vulcan-Hart Company Service Department at the address or phone number shown on the front cover of this manual.

NOTES